



RETAIL CATALOG

2025

YOUR SINGLE SOURCE SUPPLIER FOR ALL HORTICULTURAL NEEDS

ABOUT GRIFFIN

Griffin is a partner to horticulture professionals. Family owned and operated since 1947, we apply our knowledge, experience and resources to enhance customer success from production to retail.

End-to-end solutions are our specialty. We represent the industry's leading breeders and producers, spanning seed and vegetative, bedding and potted crops, ornamentals and edibles. Our grower supplies offer includes reliable inputs and equipment to help your crops thrive through all production stages. Finally, our quality retail products drive add-on sales for you, while enhancing consumer success and enjoyment.

To learn more about our company, we invite you to visit us online at www.griffins.com, follow us on LinkedIn, Instagram and Facebook.

A LEGACY OF QUALITY AND SERVICE

Charlie Griffin founded his namesake company in 1947 with a simple vision: To maximize products and service for his customers. Originally headquartered in Reading, Mass., his was a one-man operation with a limited offering, delivering supplies to growers in the local community.

Ken Hyslip, Sr. first became an employee of Griffin Greenhouse Supplies in 1952, as a truck driver at the age of 17. At the time, Griffin operated from a single location with no more than five employees. He went on to buy the business from the Griffin family in 1968. Under his leadership, Griffin grew steadily across the East Coast.

Today, Griffin thrives among horticulture's premier distributors, serving growers and retailers nationwide. Under the leadership of the Hyslip family, the business has earned a reputation for operational excellence, quality products, and first-class customer service.

We know you have many choices among supplier partners, and we sincerely thank you for your business. We look forward to serving you in the season ahead.

GRIFFIN IS COMMITTED TO EXCEPTIONAL CUSTOMER SERVICE

Our goal is simple: To meet your needs and exceed your expectations. From the time you place your order until it's delivered to your location, our team works to treat you with the utmost care every step of the way.

We strive to deliver every order on time and in full. We'll contact you 24 hours before your delivery date to ensure you're ready for the product. If we're unable to honor a delivery date, we'll notify you in advance and make every effort to reschedule at a time that's convenient for you. In the event of any issue, we're dedicated to working with you and our suppliers as needed to find a swift resolution.

Your opinion matters to us! Customer feedback is key to helping our team deliver on our service pledge. Please don't hesitate to contact me directly – by phone or e-mail – with any questions or input that may help us serve you better.

Dan Lowery | Corporate Customer Service Manager | 800.888.0054 x81404 | dlowery@griffinmail.com



GRIFFIN LOCATIONS

*Fifteen Distribution Centers
Throughout the United States*

TO PLACE AN ORDER

Online: www.griffins.com
Phone: 1.800.888.0054
Grower / Retail Fax: 1.877.636.3623
E-mail: orders@griffinmail.com

GENERAL QUESTIONS

1.800.888.0054

OFFICE HOURS

Our office is open for normal business
and telephone service from 8:00 AM to
5:00 PM, Monday through Friday.

WAREHOUSES

Hours for pick-up orders and counter
sales are 8:00AM to 5:00PM, local time,
Monday through Friday.

BRANCH LOCATIONS

5303 Havana St, Suite 120
Denver, CO 80239

1240 B Hwy 77
Bridgeton, NJ 08302

20 Grandview Ct
Cheshire, CT 06410

1 Ellis Dr
Auburn, NY 13021

10 Middle River Drive
Stafford Springs, CT 06076

2165 Montauk Hwy
Brookhaven, NY 11719

111 Bluffs Court, Suite A
Canton, GA 30114

126 Van Guysling Ave
Schenectady, NY 12305

2143 Internationale Parkway
Suite 400, Woodridge, IL
60517

28214 Glenwood Rd.
#4855, Perrysburg, OH

1619 Main St
Tewksbury, MA 01876

58 S.E. 223rd Ave.,
Gresham, OR 97030

50 W Gray Rd
Gray, ME 04039

200 Mountain View Rd
Morgantown, PA 19543

5612 Pride Rd
Richmond, VA 23224







PRODUCTION SUPPLIES

Griffin's roots are in production supplies, and they remain the backbone of our company today. We're proud to offer reliable inputs and equipment to help your crops thrive through all growing stages. Look to us for containers, growing media, chemistry and more from the manufacturers you know and trust. With the increasing demand for more efficient and environmentally friendly methods of growing food crops, we now specialize in Controlled Environment Agriculture for food and cannabis. Our 14 branch locations service customers nationwide with convenience and efficiency. Shop all of our grower products and place your order with your Griffin sales representative or on www.griffins.com.

RETAIL SOLUTIONS

Griffin is the independent retailer's best source for lawn & garden products. We make it easy for IGCs to do business, with complete vendor offerings, low order minimums and efficient shipping solutions. Raise your retail game with help from our experts! Count on us for seasonal promotion ideas, merchandising best practices and space-planning tips to maximize your display areas and drive sales. Shop all of our retail products and place your order with your Griffin sales representative or on www.griffins.com.

GREEN GOODS

Griffin is a full-service broker of live goods to professional growers. Our assortment includes seed and vegetative material, bedding and potted crops, ornamentals and edibles from the industry's most respected breeders and producers. We're uniquely committed to the seed business, stocking more than 3,300 variety/product-form combinations in our state-of-the-art seed operations facility. Count on us for annuals, perennials, grasses, herbs and vegetables. We're serious about seed quality: Inventory monitoring and regular performance testing ensure every variety meets its full potential, from the greenhouse to the garden center. Browse our complete portfolio and book your product selections through your Griffin sales representative or on www.griffins.com.

TECHNICAL SUPPORT

GGSPRO is our in-house technical services team. With more than a century of combined experience, GGSPRO delivers prompt, practical and accurate support to Griffin customers nationwide. The team's areas of expertise include: Crop culture, sanitation protocols, plant physiology and pathology, chemical controls, biological control agents (BCAs), and plant nutrition. GGSPRO endorses a holistic approach to plant protection, utilizing a mix of cultural practices alongside chemical and biological controls to manage pests and diseases. Visit www.griffins.com/ggspro or contact GGSPRO at **1.800.888.0054**.

CONSTRUCTION SERVICES

Our construction team assists with all aspects of greenhouse planning, construction and maintenance. Whether it's a new operation or expansion, upgrades or replacements, we can help with options to meet your needs and fit your budget. We offer a full range of equipment to help you grow efficiently and profitably. Look to us for greenhouse structures, films and coverings, lighting, climate control, irrigation, carts and more. Visit us at www.griffins.com/construction to learn more about our product portfolio, see our project showcase, and submit a request for a free quotation.

WHAT'S NEW!
new vendors with griffin

WEST

Bird-B-Gone242
 Green As It Gets47
 GreenGro Biologicals47-48, 251
 Organocide268
 Waupaca Northwood LLC82

NATIONAL

Backyard Nature Products373-374
 Centurion.....86-88,375-377
 D & D Garden103-105, 285, 403
 Earth Edge208-209
 Harris48, 136, 181 , 254-256
 Lewis Tools108-109, 137
 Shaxon218
 Sol Soil58-59
 Westland369

EAST

Bobbex242
 Pride Garden Products345, 405

Table of
CONTENTS



**SEED STARTING AND
 INDOOR GARDENING**

11



**SOILS, CONDITIONERS
 AND GROUND COVER**

33



**PLANT CARE
 AND FOOD**

151



**GARDEN
 ACCESSORIES**

195



BIRDING

371



**KIDS
 GARDENING**

397



LAWN CARE AND
GRASS SEED

65



TOOLS AND
EQUIPMENT

83



WATERING SUPPLIES
AND IRRIGATION

113



LAWN AND GARDEN
PROBLEM SOLVERS

225



CROP
SUPPORT

275



POTS AND
PLANTERS

295



INDEX

409



LOOK FOR QR CODES

throughout the catalog and
scan with your phone for
digital information.

CONNECT

with us

SOCIAL MEDIA

Add us to your social network! For news on products, events and more, follow us on LinkedIn and like us on Facebook. Simply log on and search "Griffin Greenhouse Supplies." Also follow us on Instagram. Log on and search "Griffin Greenhouse".



GRIFFIN GAZETTE

Published especially for top customers, the Griffin Gazette is loaded with news you can really use. Our team serves up timely production advice, retail inspiration, and product and variety information to help you bring your best crop to market.

Check out the digital Gazette! Visit www.griffins.com/publications to browse the Gazette archives.



E-MAIL PROGRAMS

We offer several topical e-mail programs for growers and retailers. Tailor your subscriptions to meet your unique needs and interests, from technical tips to product specials and much more. Visit www.griffins.com to subscribe or update your preferences.

GRIFFIN CATALOGS

From production to point-of-sale, we've got you covered! Our Grower Supplies, Seed & Plant, CEA and Retail catalogs feature must-have inputs from quality manufacturers, breeders and producers.

Contact your Griffin sales representative to request our catalogs, or check out our convenient and portable digital editions at www.griffins.com/publications.



SOURCING HAS NEVER BEEN THIS SIMPLE

One login connects you to the industry's broadest selection of products for growers and independent retailers:

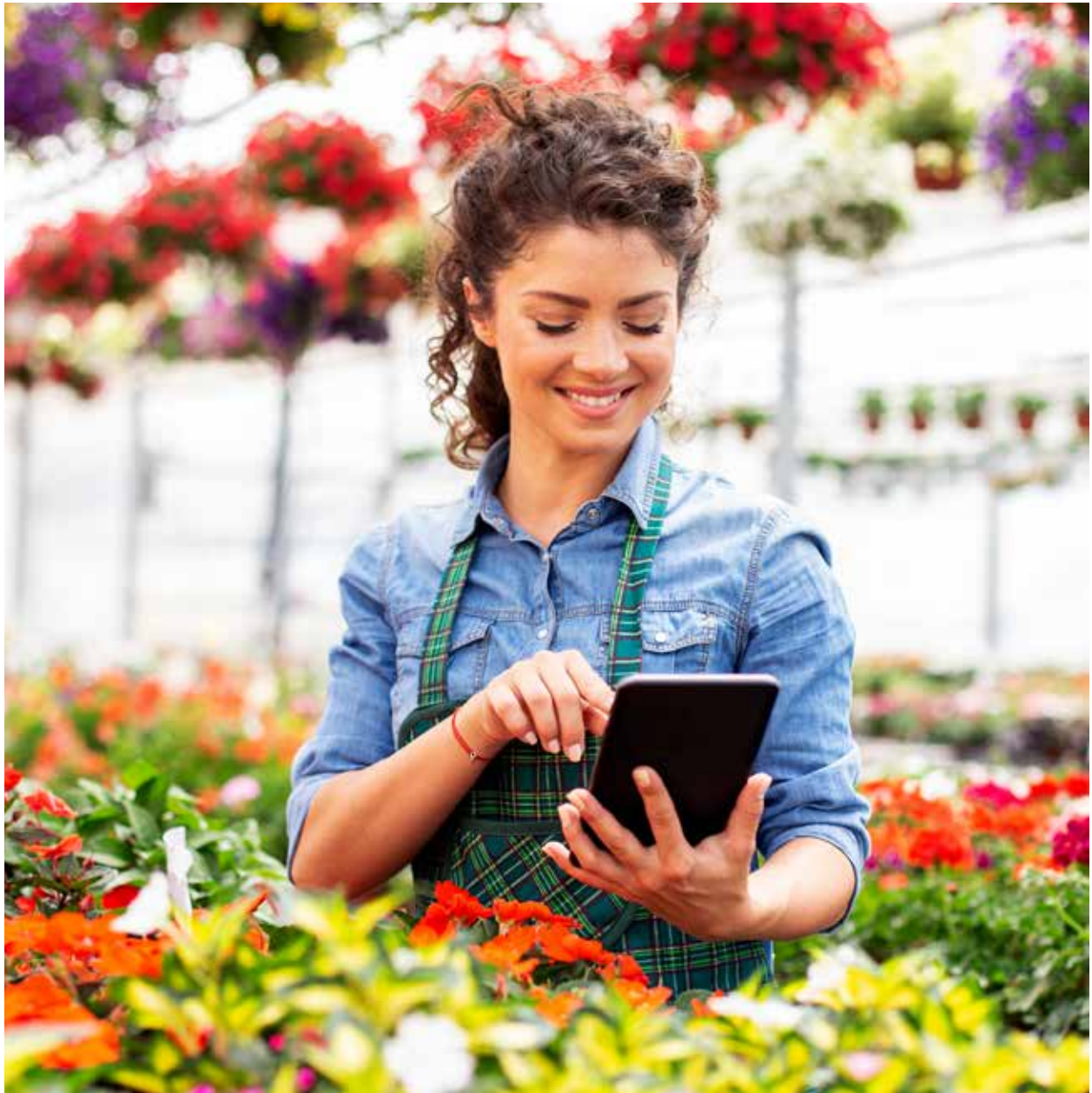

- Green goods including seed, cuttings and young plants
- Production supplies including containers, growing media and plant protection products
- Greenhouse structures and equipment
- Retail supplies including lawn & garden products, accessories and gift items

Place your order today: www.griffins.com



CHECK OUT OUR
CLEARANCE ITEMS!



GriffinExpo

SAVE THE DATE!

In-Person Expos

Expo West

August 27-28, 2025

Grand Sierra Resort Reno, NV

Expo East

September 4, 2025

Lancaster Marriott At Penn Square, Lancaster, PA

SEED STARTING & INDOOR GARDENING



CHECK OUT OUR CLEARANCE ITEMS!

DROP SHIP VENDORS

Renee's Garden

Dealer Cost: 50% off Retail

Outright Buy:

Applies only to Scatter Garden Canisters (40% off retail price)

Retail Price Point:

Cornucopia \$1.99 - \$2.49/Organic \$3.29
Renee's Garden \$2.99-\$3.69/Organic \$4.39
Scatter Garden canisters \$15.95ea

Timing:

Opening orders must be written and shipped before March 31

Freight:

4% of invoice. Scatter display \$40

Ferry Morse

Seed of Change 45% off Retail

Terms of Sale:

Both part 1 and part 2 must be ordered for all displays that ship as two parts: no partial display orders

Ouright Sales:

Terms Net 30 Days

Guaranteed Sale:

Maximum return credit of 50% of total packets shipped.
Payment Due 8/1, regardless of whether returns have taken place
\$9.50 Return Fee Applies for shipping & handling

Page Seed

Outright Sale

PrePriced:

Liberty Garden \$0.99
Organics \$2.49-\$2.99
Page Premium \$ 1.89-\$4.99
Specialty Gardens \$1.89-\$4.99
Theme \$1.89
Urban \$ 2.89

FOB Greene, New York

Livingston Seed

Buy Back Terms:

Payment Due 8/1
50% returnable, returns due by 9/30
Credit issued after return
Outright Sale 58% off Retail
Guaranteed Sale 45% off Retail
Freight is prepaid within Continental 48



Griffin Greenhouse Retail WAREHOUSE Shipping Map

We are now shipping nationwide!

NATIONAL



2025

Refer to location key:

National items are stocked nationally
 Select items are sold East or West only; no exceptions

8" Kaleidoscope Planter

Premium plastic modular planter can be displayed individually each planter has a removable saucer ideal for succulents or shallow rooted planted.

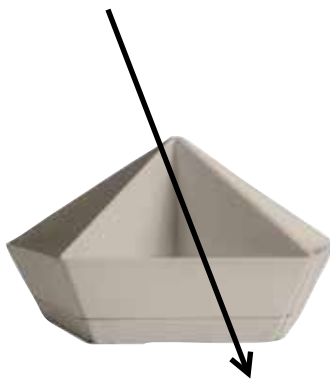

Item #	Desc	UPC	Vendor	CS/UOS	Location
80282643	Vanilla Bisque	770932844170	KDP08000A58	6/6	National

Where is the pricing?

1. Scan QR code on Chapter Pages to see pricing on Griffins.com
2. Contact your Griffin Sales Representative
3. Call into Griffin Customer Service 800.888.0054





Orchid Plus® 20-14-13

Urea-free, professionally formulated plant food, containing fast-acting nitrate nitrogen – the key component to enhancing vigorous growth in orchids. It also contains essential minor elements to combat deficiencies that occur with common soilless potting mixes. Convenient re-sealable bag.



Item #	Desc	UPC	Vendor	CS/UOS	Location
81830009	16 oz. bag	079925083030	83030	12/12	East

Houseplant, Bromeliad & Orchid Food

In addition to being a great source of nitrogen, phosphorus, and potassium, this product includes essential minor elements to combat nutrient deficiencies. Safe for use on all houseplants and orchids. No mixing, no mess; just sprinkle and go. Convenient re-sealable bag. Feeds continuously for up to 12 months.



Item #	Desc	UPC	Vendor	CS/UOS	Location
81830011	10 oz. bag	079925083078	83070	12/12	East

Orchid Better-Bloom® 11-35-15

Urea-free, professionally formulated plant food containing high-content phosphorous; a powerful blooming agent! This secret formula was developed by our own master growers and is used in our greenhouses to accelerate flowering, enhance bloom color and maximize bloom size. Convenient re-sealable bag.



Item #	Desc	UPC	Vendor	CS/UOS	Location
81830010	16 oz. bag	079925083054	83050	12/12	East

SOCIAL MEDIA
Connect with us!

We offer several topical posts for growers and retailers. Follow us and check out our posts!

Instagram: **@griffin_greenhouse**
Facebook: **Griffin Greenhouse Supplies, Inc.**
Linkedin: **Griffin Greenhouse Supplies**



Square Tray

39.5" X 39.5" X 4.75"



Item #	Desc	UPC	Vendor	CS/UOS	Location
82010501	Square Tray	5031670002570	N130	2/2	National

Giant Plus Tray

47" X 21.5 X 2"



Item #	Desc	UPC	Vendor	CS/UOS	Location
82010573	Giant Plus Tray	5031670002143	N124	6/6	National

Indoor Plant Pot Tray

19" X 6" X 0.75"H



Item #	Desc	UPC	Vendor	CS/UOS	Location
82010627	Indoor Plant Pot Tray	5031670001832	N114	10/10	National

Maxi Tray

31" X 16" X 2"H



Item #	Desc	UPC	Vendor	CS/UOS	Location
82010629	Maxi Tray	5031670002020	N120	10/10	National

Coir Chips Bricks

Each brick makes up 1.6 gallons of growing material. Grown, harvested, and processed in Sri Lanka. Just put the brick in a bucket with warm water and watch the brick gradually absorb the water. For quicker expansion, chip away at the brick as it becomes moist exposing dry layers.



Item #	Desc	UPC	Vendor	CS/UOS	Location
82010186	6qt	721082064758	F475	10/10	National

TRUSTED SINCE 1926
BONIDE®



2025

Mite-X®

A specific miticide for houseplants. Also kills aphids and thrips. A pleasantly scented Garden Naturals® product made from botanical extracts. **Not for sale in PR**

Item #	Desc	UPC	Vendor	CS/UOS	Location
80100005	12 oz.	037321001140	114	8/8	National

Bontone® Rooting Powder

Ideal for houseplant cuttings. Speeds root development for ornamentals, vegetables, fruit trees, and berries. Simply cut, dip, and plant.

Item #	Desc	UPC	Vendor	CS/UOS	Location
80100041	1.25 oz.	037321009252	925	12/12	National

Systemic Houseplant Insect Control

For use in potted plants. No odor, easy to use granules provide insect control for up to 8 weeks!

Not for sale in CA, CT, ME, MA, NJ, PR, RI, CO

Item #	Desc	UPC	Vendor	CS/UOS	Location
80100043	8 oz.	037321009511	951	12/12	National

Liquid Plant Food 10-10-10

A balanced fertilizer ideally formulated for houseplants. Just seven drops per quart of water for lush, healthy plants. **Not for Sale in PR**

Item #	Desc	UPC	Vendor	CS/UOS	Location
80100049	8 oz.	037321001089	108	12/12	National

Liquid Orchid Food 9-7-9

This 9-7-9 formula designed specifically for orchids provides nutrients for healthy and robust blooms. Approximately 10 drops per quart of water. Simply dilute Bonide Liquid Orchid Food with water before application. Do not store diluted product. Carefully read label directions before use.

Item #	Desc	UPC	Vendor	CS/UOS	Location
80100847	8 oz.	037321001058	105	12/12	National

Insecticidal Soap - Organic

1% Potassium fatty acids. Derived from plants - for plants, Kills insects on contact. For indoor and outdoor use. **Not for Sale in PR**

Item #	Desc	UPC	Vendor	CS/UOS	Location
80100051	12 oz.	037321001126	112	8/8	National

Leaf Shine & Moisture Guard

Anti-transpirant reduces harmful water loss. Adds a natural looking shine. For use on all houseplants with hard faced leaves.

Item #	Desc	UPC	Vendor	CS/UOS	Location
80100052	12 oz.	037321001164	116	8/8	National

Liquid African Violet Plant Food

Just a small amount with each watering brings forth beautiful blooms, lush foliage and excellent plant vigor of all flowering plants. Formula 7-10-7 AVF

Item #	Desc	UPC	Vendor	CS/UOS	Location
80100797	8 oz.	037321001065	106	12/12	National

Liquid Cactus Plant Food

With a 2-7-7 N-P-K ratio, this tropical plant food has been specifically formulated to meet the unique needs of cacti and succulents.

Item #	Desc	UPC	Vendor	CS/UOS	Location
80100798	8 oz.	037321001072	107	12/12	National

Coast of Maine

Sprout Island Blend™ Organic & Natural Seed Starter



A rich mixture of blended mycorrhizae, sphagnum peat moss, well-aged compost, perlite, lime, kelp meal, worm castings, and lobster meal. Designed specifically for germinating seeds and rooting cuttings, and growing them into healthy, disease resistant plants.

Item #	Desc	UPC	Vendor	CS/UOS	Location
81600029	16 qt	609853000917	SI4002	4/4	East
81600045	2 cf	609853000924	SI2000	48/4	East

Stonington Blend™ Organic & Natural Grower's Mix



Grow Clean! Stonington Blend was created specifically for growing Cannabis. Rich in nutrients and formulated with amendments designed to boost budding, blooming and root development, this complex "super soil" will take your plants growing in the vegetative stage to the next level! Designed for high performance growing in containers and large pots, this blend incorporates mycorrhizal fungi, kelp, fish bone and alfalfa meals, worm castings, peat, coir, and lobster compost. For best results, grow in 15 gallon containers.

Item #	Desc	UPC	Vendor	CS/UOS	Location
81600012	1.5 cf.	609853000689	ST1500	60/6	East

DRAMM

Little Buddy™ Hydroponic Shears

The 3" long blades are narrow to allow for precise cutting of hydroponic crops. The Hydroponic Shears are bright yellow for visibility.



Item #	Desc	UPC	Vendor	CS/UOS	Location
80170144	Titanium	036434180339	1018033	12/12	National
80170145	S. Steel	036434180377	1018037	12/12	National



Indoor! 2-2-2

8 oz. liquid concentrates contain natural proteins and beneficial microbes that provide beautiful results. The innovative easy-dose cap pours the perfect amount without any measuring or mess.

Not for Sale in HI

Item #	Desc	UPC	Vendor	CS/UOS	Location
80030165	8 oz.	050197305082	INPF8	6/6	National

Violet! 1-3-1

8 oz. liquid concentrates contain natural proteins and beneficial microbes that provide beautiful results. The innovative easy-dose cap pours the perfect amount without any measuring or mess.

Not for Sale in HI

Item #	Desc	UPC	Vendor	CS/UOS	Location
80030167	8 oz.	050197307086	VIPF8	6/6	National

Cactus! 1-2-2

8 oz. liquid concentrates contain natural proteins and beneficial microbes that provide beautiful results. The innovative easy-dose cap pours the perfect amount without any measuring or mess.

Not for Sale in HI

Item #	Desc	UPC	Vendor	CS/UOS	Location
80030166	8 oz.	050197306089	CAPF8	6/6	National

Orchid! 1-3-1

8 oz. liquid concentrates contain natural proteins and beneficial microbes that provide beautiful results. The innovative easy-dose cap pours the perfect amount without any measuring or mess.

Not for Sale in HI

Item #	Desc	UPC	Vendor	CS/UOS	Location
80030168	8 oz.	050197308083	ORPF8	6/6	National

Organic Seed Starter Mix

For all seedlings and cuttings. Premium blend of sphagnum peat moss, peat humus and perlite that has been enriched with Myco-tone®. Promotes root growth and improves moisture retention.

Not for Sale in HI

Item #	Desc	UPC	Vendor	CS/UOS	Location
80030041	8 qt.	050197705080	SS8	6/6	National
80030097	16 qt.	050197705165	SS16	6/6	East



Seed & Cutting Mix

Ideal starter for germinating seeds and rooting leaf, stem, and root cuttings. The sphagnum peat blend with a wetting agent provides an excellent balance between moisture retention and air capacity to prevent root disease while promoting efficient rooting.



Item #	Desc	UPC	Vendor	CS/UOS	Location
82280383	8 qt.	066498099254	9925	6/6	East
82280382	16 qt.	066498099292	9929	120/10	East



Grow Big® Hydroponic Liquid Plant Food 3-2-6

Liquid concentrate fertilizer specifically designed for hydroponic use. Designed to enhance plant size and structure, allowing for more abundant fruit, flower and bud development.



Item #	Desc	UPC	Vendor	CS/UOS	Location
82000110	1 pt	752289793219	793219	12/12	National

SOWING YOUR OWN PRODUCTION?

Sow something Altogether. Better. Griffin stocks 3,300+ seed variety/product-form combinations—annuals, perennials, grasses, herbs and vegetables – in a broad range of packet sizes and product forms to meet your needs. Browse the full assortment in our Seed & Plant catalog.



Clonex® Clone Solution

Clonex® Clone Solution is a plant nutrient specifically formulated for rooted clones and seedlings. It contains a special blend of the highest quality minerals including Nitrogen, Phosphorus, Potassium, and Calcium plus other essential elements that all plants require for vigorous growth.

Item #	Desc	UPC	Vendor	CS/UOS	Location
81860076	20ML packet	659627000513	CCSPACKET	18/18	National
81860077	1 Quart	659627009004	CCSQT	12/12	National
81860078	1 Gallon	659627009011	CCSGAL	4/4	National
81860079	2.5 Gallon	659627009028	CCS2.5GAL	2/2	National

Clonex® Rooting Gel

Clonex® Rooting Gel contains a unique blend of hormones, anti-fungal agents, vitamins, and minerals in a highly tenacious and stabilized gel base. The Clonex® formulation has been fine-tuned to give the explosive root development and for this reason serious growers and plant nurseries depend upon it for successful and profitable plant propagation.



Item #	Desc	UPC	Vendor	CS/UOS	Location
81860068	15ML packet	659627002043	CLOGELPK	108/108	National
81860067	100ML	659627002029	CLOGEL100ML	12/12	National
81860069	250ML	659627002036	CLOGEL250ML	12/12	National
81860074	Gel pint	659627002074	CLOGELPT	6/1	National
81860075	Gel quart	659627002050	CLOGELQT	4/1	National
81860093	Gallon	072532000179	CLOGELGAL	2/2	National
81860096	Mist Conc. Gal	659627000946	CLOMIST-CONGAL	4/4	National

Root Riot™

Ideal for rooting plant cuttings and starting seeds. Root Riot™ cubes provide the perfect environment for root initiation and development. Made from composted natural materials, these plant starter plugs have a great spongy texture which retains the perfect air/water ratio for healthy, rapid root growth. Trays do not contain root riot gel.



Item #	Desc	UPC	Vendor	CS/UOS	Location
81860090	Bag of 50	659627011076	RTRTBAG50	20/20	National
81860089	Bag of 100	5025644812678	RTRTBAG100	12/12	National
81860092	Box of 1500	659627000605	RTRTBULK	1/1	National
81860095	Tray of 50	659627011038	RTRTRTRY50	12/12	National



Seed Starter

Specially formulated soilless mix to promote superior germination of seeds. Contains six components blended in proper proportions. Light weight, loose and fertile. Also useful for transplanting or cuttings.



Item #	Desc	UPC	Vendor	CS/UOS	Location
80070032	4 qt.	071605301014	30101	12/12	East
80070030	10 qt.	071605301038	30103	6/6	East
80070031	18 qt.	071605301182	30118	4/4	East



Dirt Pot Flexible Portable Planters

Featuring porous breathable fabric that is made from 100% recycled water bottles. These planters allow your plants to thrive by promoting exceptional root health and vigorous plant growth. Dirt Pots are stronger than similar products, with reinforced seams and stitching. With handles.



Item #	Desc	UPC	Vendor	CS/UOS	Location
80880032	7 Gal	638104001342	HGDB7	10/10	National
80880029	10 Gal	638104001359	HGDB10	10/10	National

Germination Station w/ Heat Mat & Dome

Germination station with heated mat. Grow healthier starts, increase germination success and better humidity control for optimum growth. Includes UL listed waterproof heat mat, 17 watts/120 volt, 2" humidity dome, 11"x 22" watertight base tray, 72 cell seedling inserts, instructions with growing tips and seed starting booster.



Item #	Desc	UPC	Vendor	CS/UOS	Location
80880006	72 Cell	638104640503	CK64050	12/4	National

Digital Temp Controller for Heat Mat

The heat mat thermostat is digital for greater accuracy. The stainless steel temperature probe can be submerged in water. Digital temperature controller for heat mats. Provides constant optimum temperatures for specific crops. Controls temperature in colder or warmer environments. Illuminated indicator light; 3-prong ground plug. Compatible with all heat mats; optional for Hydrofarm Heat Mats. Controllable range from 68 - 108° Fahrenheit. Celsius or Fahrenheit read-out (hold Up or Down button to change). Max current: 8.3 amps / 1000 watts.

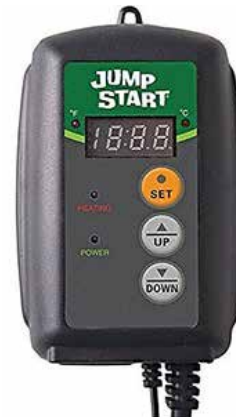

Item #	Desc	UPC	Vendor	CS/UOS	Location
80880005	1000 w	638104100038	MTPRTC	6/6	National

Windowsill Heat Mat

This windowsill heat mat is perfect for veteran growers, beginners, and children too. It is the perfect size for small growing spaces, and improves germination by warming the root area 10-20°F over ambient temperature. By warming the roots you increase your growing success as this mat will maintain a controlled temperature all season long. UL listed. Power cord included. 120 Volt. 6' power cord.



Item #	Desc	UPC	Vendor	CS/UOS	Location
80880001	3"x20" 7.3W	638104000116	MT10004	10/10	National

Seedling Heat Mats

Re-engineered for better performance and greater durability! The new, stronger heating wire, and thicker multi-layer construction offers more uniform heating and the durability to withstand rugged greenhouse environments. Increases success of seedlings and cuttings. Warms root area 10-20°F over ambient temperature to improve germination. Lighting, watering, and planting information printed on mat. Waterproof construction. Has a 6' power cord. The only UL-listed seedling heat mats on the market! 50% thicker construction.

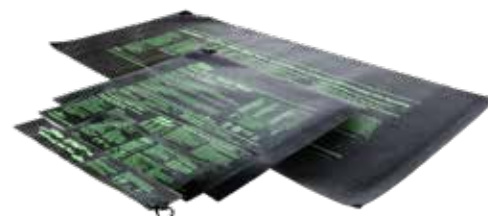

80880002- 8 1/2" x 19 1/2"
80880003- 20" x 20"
80880004- 48" x 20"

Item #	Desc	UPC	Vendor	CS/UOS	Location
80880002	17 Watt	638104100069	MT10006	10/1	National
80880003	45 Watt	638104100083	MT10008	10/1	National
80880004	107 Watt	638104100090	MT10009	6/1	National



Jump Start Grow Light Systems

Ideal for seedlings, cuttings, flowers and house plants. Grow seedlings faster with 15-20% more lumens. Simple toggle clamp for easy lamp height adjustment. Super easy assembly. Internal reflective finish directs more light to plants. CE Certified.



Item #	Desc	UPC	Vendor	CS/UOS	Location
80880202	2' w/timer	638104025669	JSV2T	6/6	National
80880203	4' w/timer	638104025676	JSV4T	6/6	National

Bonsai Shears

The Hydrofarm Bonsai Shears offer precise cutting, making them ideal for bonsai and delicate plant pruning.



Item #	Desc	UPC	Vendor	CS/UOS	Location
80880133	60MM	63810410647	HGBS600	12/12	National

GROW!T Clay Pebbles

GROW!T horticultural clay pebbles are made from 100% natural clay. They are clean, pH stable, and offer great aeration and drainage in hydroponics, especially in flood and drain, deep water culture, and drip feed systems. Due to their unique structure and ability to cover a large surface area, they offer the ideal environment to foster beneficial bacterial growth around the root zone, leading to naturally healthier plants.



Item #	Desc	UPC	Vendor	CS/UOS	Location
80880011	10L	5034517150250	GMC10L	91/1	National
80880205	40L	638104013444	GMC40L	80/1	National

Geolite Clay Pebbles

GEOLITE clay pebbles serve as a strong, durable and versatile media, perfect for hydroponics and many horticultural applications. Made from 100% natural Italian clay, this media is industrially produced at extremely high temperatures (2200°F/1200°C) and specially treated for a consistent EC and stable, neutral pH. It offers great aeration and drainage, ensuring success with technically one of the best growing medias for your indoor garden.



Item #	Desc	UPC	Vendor	CS/UOS	Location
80880206	45L	638104013758	GMGC45L	80/1	National



GROW!T Organic Coco Coir

They retain water, making sure plants never go thirsty, but due to their texture, they also offer excellent drainage properties. Plants are no longer at risk of "drowning" in too-packed or over-watered soil. Instead, Plant!t's ideal consistency gives them room to breathe and for roots to grow freely, capturing that essential air-to-water ratio for your biggest growth yet.

Item #	Desc	UPC	Vendor	CS/UOS	Location
80880013	Planting Chips - 2 cu. ft.	638104002554	JSCC2	1/1	National
80880015	Mix - 2.5 cu. ft.	638104002547	JSCCM25	1/1	National
80880016	Mix Brick - 3 Pack	638104006804	JSCP3	5/5	National

Roots Organics Formula 707

Formula 707 is different from the other growing mixes created by Aurora Innovations. It was designed with greater water-holding capacity, fewer nutrients, less perlite and less pumice, and it contains ingredients specific to large container gardening. In fact, the packaging is a 30 gal. grow bag containing about 20 gal. of the finest quality potting mix. Just punch holes in the bottom, cut off the top and plant.



Item #	Desc	UPC	Vendor	CS/UOS	Location
81270173	1.5 cu. ft.	609728631901	RO7071.5	70/70	National
81270001	3 cu. ft.	609728631895	RO707	36/36	National

Original Potting Soil

Roots Organics Original is a ready to use mix created with a balanced air to water ratio of porosity and water retention to allow for frequent feeding of fast growing, heavy feeding plants.



Item #	Desc	UPC	Vendor	CS/UOS	Location
81270002	1.5 cu. ft.	609728631857	ROD	70/70	National



Precision Lightweight Pink Pruner

These lightweight anti-fatigue pruners are based on our immensely popular classic Hydrofarm pruners, favored by legions of horticulturists. Their surgical stainless steel blades offer serious cutting capacity in a lightweight package.

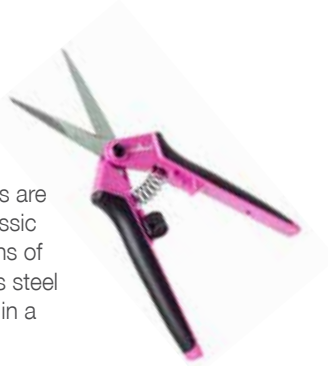

Item #	Desc	UPC	Vendor	CS/UOS	Location
80880158	Pink Pruner	638104021470	HGPL400P	12/12	National

Bonsai Shears

Ancient wisdom supports cutting and shaping bonsai trees for peace, stress relief and creativity, but modern wisdom shows that you need the proper tools to enjoy the most out of the experience. Whether you're crafting bonsai branches or taking other cuttings, Hydrofarm's bonsai shears offer exactly what you need. Reap the true meaning of a quick snip while still getting exact precision in each cut.

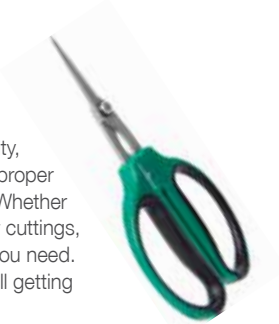

Item #	Desc	UPC	Vendor	CS/UOS	Location
80880236	40mm	638104106030	HGBS400	12/12	National

Active Air 3-Way Meter

The durable, easy-to-read tester is suitable for indoors or out and needs no batteries to operate. Remove from soil and clean prongs after each use to ensure the moisture meter stays in top performance shape.



Item #	Desc	UPC	Vendor	CS/UOS	Location
80880230	3 - Way Meter	638104190251	MGMLP1	12/12	National

Jump Start AccelaROOT

Start growing on a small scale, then watch your plants take root! The AccelaROOT 50-cell Insert with Tray & Plugs gives you up to 50 small "homes" for your seedlings and cuttings. Once you've started to sprout, plugs come out of the tray cells easily to be transplanted into bigger pots or a garden setup, letting you start all over again—with the same tray.



Item #	Desc	UPC	Vendor	CS/UOS	Location
80880229	50 Cell Tray	638104000079	JSAR50	12/12	National

Mini Measure Shot Glass

Measure for measure, the Hydrofarm Mini Measure Shot Glass is ideal to measure water, nutrients, and other liquids in teaspoons, tablespoons, ounces, and milliliters. Includes 12 each, 1oz Mini measure glasses.



Item #	Desc	UPC	Vendor	CS/UOS	Location
80880067	2.5in X 6cm 12 Pack	638104000970	HGMMSG	12/12	National

7.5" Vented Dome

These domes fit directly onto the standard 10 x 20" cut kit trays to create a humid and warm environment ideal for cuttings and seed germination. Tall 7.5" dome gives extra height for your taller cuttings. Adjustable vents allow for perfect humidity and temperature control. 22.0"L x 11.3"W x 7.8"H

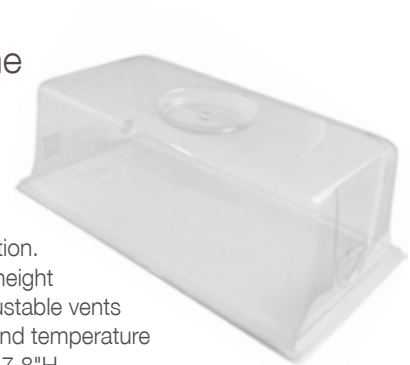

Item #	Desc	UPC	Vendor	CS/UOS	Location
80880044	7.5" Dome	638104010566	CK64081	25/25	National

Humidity Dome 2"

2 inches, humidity heavy duty plastic dome, will help retain moisture & heat to improve seedling germination, includes 3 vents to help control heat & humidity, for use with 10 inches x 20 inches trays, not included.



Item #	Desc	UPC	Vendor	CS/UOS	Location
80880238	2" Dome	638104010573	CK64001	25/25	National

Mondi 7" Mini Greenhouse

Regulates air flow with two adjustable vents that allow you to adjust temperature and humidity, better results for the garden. Heavy duty 7" vertical design fits tightly onto standard 10" x 20" flats, reducing moisture loss, while giving more cubic volume for plants. 7 1/2" H X 11" W X 21 1/4" L



Item #	Desc	UPC	Vendor	CS/UOS	Location
80880141	7" Dome	638104640909	MONDIG100	50/50	National



JACK'S NUTRIENTS LINE

SOLUBLE. AVAILABLE. CONSISTENT.

Since 1947, these are the three words that you have come to expect when you open a bag of fertilizer made by the Peters' Family - and now, the master-crafters at Jack's introduce our small batch blends, Jack's Nutrients: A collection of formulas that gives you choices that work for many different controlled environments without the hype or confusion of extravagant names and crazy labels.



The Jack's FeED line is comprised of complete nutrient formulations. Everything your plants need for each stage, from start to finish.



15-5-20

Allow your plants to drink up this formula designed to provide all the macro, secondary and micro nutrients in a one-part system. Specifically formulated for tap, city or well water types with slightly higher alkalinity & pH. This combination of nutrients will lower pH over time while including the extra soluble calcium, magnesium and the right balance of micronutrients.

Item #	Desc	UPC	Vendor	CS/UOS	Location
80060048	2.2 lb.	671341790518	79051	6/6	National

10-30-20 Bloom

Need a Boost of Flower Power? Our 1:3:2 major nutrient ratio has been trusted by Jack's Professional growers for over 70 years. This soluble and available nutrient combination stimulates blooming, resulting in heavy bud and fruit set.

Item #	Desc	UPC	Vendor	CS/UOS	Location
80060049	2.2 lb.	671341790617	79061	6/6	National

15-6-17 Clone

Like a shot gun start for your new plants - this formula will help promote strong and fast root growth and expansion. Best used for fertilizing young seedlings, transplants, clones and newly set rooted cuttings.

Item #	Desc	UPC	Vendor	CS/UOS	Location
80060050	2.2 lb.	671341790716	79071	6/6	National

12-4-16

For the Pures in you. This one part nutrient blend is designed for crops grown in very low alkalinity waters such as reverse osmosis (RO) water, rainwater, and distilled water. Formulated utilizing the innovative raw materials to reduce pH crash while delivering all the nutrients essential for vigorous plant growth.

Item #	Desc	UPC	Vendor	CS/UOS	Location
80060047	2.2 lb.	671341790419	79041	6/6	National

7-15-30 Finish

You've always been told to finish strong. This formula is ideally formulated for this purpose to provide your plants with a very low nitrogen, high phosphorus and very high potassium content to keep the whole plant happy to the end of its crop cycle.

Item #	Desc	UPC	Vendor	CS/UOS	Location
80060053	2.2 lb.	671341790211	79021	6/6	National

5-12-26 Part A

An improvement on the classic "Part A" formula for general vegetative growing. This redesigned blend is built with purely soluble and available nutrients to allow the grower maximum flexibility. Specific balance of macro, secondary and micronutrients delivers an efficient combination of nutrients suitable for many different growing environments and crop types.

Item #	Desc	UPC	Vendor	CS/UOS	Location
80060046	2.2 lb.	671341790310	79031	6/6	National



The Jack's Boost line is all the little extras your plants may need. Do you need calcium or extra nitrogen? These supplements and more are found in the Jack's Boost Line.



15-0-0 Cal Nit Part B

An essential "Part B" provides a very soluble and available source of calcium in a two-part nutrient system. Contains very pure and completely available calcium and nitrate nitrogen nutrient sources.

Item #	Desc	UPC	Vendor	CS/UOS	Location
80060052	2.2 lb.	671341790815	79081	6/6	National

Magnesium Sulfate Epsom Salts

Two essential elements of every Jack's Nutrients program. Mg and S are known for their greening effect in plant growth with bold ions central to chlorophyll production. One of life's original "salts", Jack's epsom made it through extensive quality testing to ensure the lowest amount to heavy metals possible - so you can be sure you are feeding Mg and S, nothing else.



Item #	Desc	UPC	Vendor	CS/UOS	Location
80060060	2.2 lb.	671341791611	79161	6/6	National



Natural & Organic Starter Mix

A premium seed starter soil that contains the ingredients of Canadian Sphagnum Peat Moss and Wood Pulp.



Item #	Desc	UPC	Vendor	CS/UOS	Location
81870052	10 qt.	33349056186	G310	8/8	National
81870053	16 qt.	33349416201	G316	3/3	National



Seed Starter Greenhouse Trays

Dimensions: 2.5"H x 21"W x 10.8"D. Sturdy base tray is reusable and recyclable. Includes tray and pop out cells.

Item #	Desc	UPC	Vendor	CS/UOS	Location
81870077	72 cell	33349660093	T72HST-14	14/14	National



Greenhouse Kit

Our highest pellet count in a kit, this greenhouse is perfect for starting your garden indoors. As a bonus, get your seedlings started off strong with a sample of SUPERthrive, a kelp-based vitamin for plants!

Item #	Desc	UPC	Vendor	CS/UOS	Location
81870082	36mm -72 Cell	33349660406	J372PROGS	20/20	National



Greenhouse Kit

Ideal for greenhouse project for growing flowers and vegetables. Square peat pots ensure enough space for tender roots.

Item #	Desc	UPC	Vendor	CS/UOS	Location
81877174	50cell Peat	03349660109	TS50HST8	8/8	National

Peat Pots



Item #	Desc	UPC	Vendor	CS/UOS	Location
81870041	2 round 12 pack	33349412111	JP212	44/44	National
81870043	3 round 10 pack	33349031107	JP310	37/37	National
81870042	2 round 26 pack	33349412142	JP226	16/16	National
81870046	4 round 6 pack	33349414443	JP406	28/28	National
81870044	3 round 22 pack	33349413187	JP322	18/18	National
81870048	5 round 6 pack	33349050825	JP506	16/16	National

Strips



Item #	Desc	UPC	Vendor	CS/UOS	Location
81870049	32 pots	033349412548	JS32	20/20	National
81870050	50 pots	033349412517	JS50	30/30	National





Windowsill Greenhouse

Convenient no mess way to start seed, just add water, pellet expands to form pot and soil in one. Includes watertight tray and humidity dome. Great space saver.

Item #	Desc	UPC	Vendor	CS/UOS	Location
81870081	36mm 12cell	33349660376	J312G	17/17	National



Gro-Dome & Tray

Gro-Dome fits most 11" x 22" trays

Tray and Dome are sold separately.

Item #	Desc	UPC	Vendor	CS/UOS	Location
81870030	Dome	33349412210	TDOME	50/50	National
81870031	Tray	33349412340	TTRAY	50/50	National

Peat Pellet Bulk Packs

Bulk contains 1,000 42mm peat pellets. Sold as bulk pack only.



Item #	Desc	UPC	Vendor	CS/UOS	Location
81870019	42 mm	033349007010	J3BULK	1/1	National

Peat Pellet Refills



Item #	Desc	UPC	Vendor	CS/UOS	Location
81870026	25 peat pellets 42mm per pack	33349077501	J4REFILL	29/29	National



Fern & Palm Spikes

Keeping your ferns and palms healthy and fertilized is easier than ever with Jobe's fern and palm plant food spikes. Jobe's spikes provide a continuous supply of important nutrients right at the roots, where plants need it most. Simply insert the pre-measured, specially formulated spikes into the soil around your plant. Unlike other fertilizers, Jobe's fern and palm spikes eliminate mess, hazards and smells and don't wash away when you water.



Item #	Desc	UPC	Vendor	CS/UOS	Location
80180030	30 Pack	073035151016	05101	24/24	National

Jobe's® Food Spikes

Spikes provide a continuous supply of important nutrients right at the roots, where plants need it most. The premeasured, specially formulated spikes are simply inserted into the soil around your plant. Unlike liquids or granular, Jobe's Houseplant Spikes eliminate mess, hazards and smells – and can't wash through when you water. 50 spikes per package.



Item #	Desc	UPC	Vendor	CS/UOS	Location
80180028	House plant 13-4-5: 50 Pack	073035250016	05031T	18/18	National
80180029	Flowering plant 10-10-4: 50 Pack	073035252010	05231T	18/18	National



Jobe's® Potted Plant & Hanging Basket Spikes 6-18-6

Slow release formula feeds roots for vigorous growth and large, beautiful blooms. Feeds for up to eight weeks. 18 spikes each.

Item #	Desc	UPC	Vendor	CS/UOS	Location
80180149	Blister Pk	073035061483	6100	12/12	National
80180027	Pouch	073035061056	6105	24/24	National



Copper Label

Long-lasting copper and zinc labels for labeling like the professionals. Weather resistant packaging. 4 per pack. 12 packs/case.



Item #	Desc	UPC	Vendor	CS/UOS	Location
80140108	6" 4pk	035307008619	861	12/12	National

Zinc Label

Long-lasting zinc labels for labeling like the professionals. Weather resistant packaging.



Item #	Desc	UPC	Vendor	CS/UOS	Location
80140109	6" 4pk	035307008626	862	12/12	National
80140116	10" 10pk	035307007827	782	12/12	National

Dial Seed Sower

Provides for the even distribution of seeds with a convenient six-setting rotary dial for different seed sizes. Easily vibrates garden seed to soil. Helps make straight rows.



Item #	Desc	UPC	Vendor	CS/UOS	Location
80140090	Dial Seed Sower	035307008039	803	12/12	National

Rapiclip® Mini Seedmaster

Makes sure small seeds are planted exactly where you want them with this small plunger-type dispenser.



Item #	Desc	UPC	Vendor	CS/UOS	Location
80140092	Seeder	00353078053	805	12/12	National

Wood Plant Labels

Clearly label all your seeds and plants for easy identification. Each pack contains 24 wood plant labels. 12 packs/case.



Item #	Desc	UPC	Vendor	CS/UOS	Location
80140095	6" 24pk	035307008121	812	12/12	National

Luster Leaf Plant Labels

Luster Leaf's labels are for all applications. Clearly label all of your seeds and plants for easy identification.



Item #	Desc	UPC	Vendor	CS/UOS	Location
80140103	4" 50pk	035307008275	827	12/12	National
80140102	6" 25pk	035307008268	826	12/12	National
80140105	6" 50pk	035307008404	840	12/12	National
80140107	8" 30pk	035307008435	843	12/12	National

"T" Labels

These plant labels make it easy to label with seed packet or write on label area.



Item #	Desc	UPC	Vendor	CS/UOS	Location
80140099	6" 10pk	035307008206	820	12/12	National
80140098	8" 10pk	035307008183	818	12/12	National
80140097	13" 5pk	035307008176	817	12/12	National

Coco Coir Brick

Premium seed starter mix an ideal growing medium for organic applications.



Item #	Desc	UPC	Vendor	CS/UOS	Location
80140205	1.4 LB	35307012500	1250	12/12	National



Seed & Cutting Mix

Lambert Seed & Cutting Mix plays a big part in successfully completing the process of germination. It drains well and easily fills seedling trays. This media works very well in anchoring unrooted cutting, surrounding the stem with a substrate that also provides moisture and encourages root formation.



Item #	Desc	UPC	Vendor	CS/UOS	Location
81940019	8 qt	066498076101	6649807610	6/6	East
81940042	16 qt	066498076118	6649807611	120/6	East



LED Plant light Adjustable

Our Adjustable LED Plant Light is an energy-efficient LED light ideal for a wide variety of houseplants. With a programmable timer, you can ensure your



plants receive the perfect amount of light throughout the day, while the 5-level dimmable feature allows you to customize the light intensity to suit plants' unique requirements. This light can also be extended from 8 inches to 28 inches, making it suitable for plants of different sizes and stages of growth.

Item #	Desc	UPC	Vendor	CS/UOS	Location
82370047	28" White	676307771129	PLNLT-0001	12/12	National
82370048	28" Black	660111997042	PLNLT-0002	12/12	National

2025



NoDampOff™ Organic Seed Starting Medium

Amazing seed germinating medium for all types of seeds, bulbs, and plants. Mother Nature's surest and safest starting medium for almost 100% seed germination. Eliminates damping off disease. No chemical protectants nor sterilization required. Less over-watering danger. Produces tremendous root systems. Growth rate can be controlled by regulating fertilization.



Item #	Desc	UPC	Vendor	CS/UOS	Location
80130025	2 Bushel Sack	10367000025	ML0002	1/1	East



PlantBest Seed Starting Pallet

- (7) 50 Coconut Coir Pot Greenhouse Kit
- (14) 16 Coconut Coir Greenhouse Kit
- (6) 28 Coconut Coir Pot Greenhouse Kit
- (20) 50 42mm Coconut Pellet Greenhouse Kit
- (48) 2.50" Biodegradable Coconut Coir Pot 12/pack
- (54) 3.00" Biodegradable Coconut Coir Pot 8/pack
- (12) 4.50" Biodegradable Coconut Coir Pot 6/pack
- (7) 72 Cell Plastic Greenhouse Kit
- (14) 36 Cell Plastic Greenhouse Kit
- (72) 50 42mm Coconut Coir Pellet Refill + Cardboard Displayer



Item #	Desc	UPC	Vendor	CS/UOS	Location
81910056	½ Pallet	50775578461472	3486	1/1	East

SucSeed Seed Starter

Milled long fibered sphagnum moss has been recommended by professionals as the only renewable seed starter. Made from Wisconsin-grown long fibered sphagnum moss plant, SucSeed® is free of peat, which can contain harmful damping-off bacteria that could kill your seedlings. SucSeed® Seed Starter gives your seeds the best chance of achieving the highest seed germination rate available.



Item #	Desc	UPC	Vendor	CS/UOS	Location
80130071	244 cu. in. bag	010367000032	ML0003	12/12	East

Greenhouse Kit

Coconut Coir Pots are more durable when compared to peat pots. They are also resistant to mold growth. Kits include 100% Organic Coconut Coir pot strips, professional greenhouse tray and humidity dome.



Item #	Desc	UPC	Vendor	CS/UOS	Location
81910002	16-2.5" coir cell GH Kit	770932055408	3449	12/12	East
81910040	36-1.75" plastic cell GH Kit	770932553027	3455	12/12	East
81910001	50-1.75" coir cell GH Kit	770932054425	3448	7/7	East
81910039	50-1.75" plastic cell GH Kit	770932503022	3454	7/7	East

Coco Coir Pot

100% natural and biodegradable coconut fibers; sustainably made from the fibers harvested from coconut shells; ideal for seed starting and fast and easy germination.



Item #	Desc	UPC	Vendor	CS/UOS	Location
81910016	2.5" 12pk	770932039408	3488	24/24	East
81910017	3.25" 8pk	770932048400	3489	24/24	East
81910021	3.25"	10770932001860	3032	1540/1540	East
81910023	4"	20775578461525	3141	1344/1344	East
81910022	4.25"	20775578461518	3072	1032/1032	East
81910031	4.25" sq.	20775578461594	3136	600/600	East
81910024	4.5"	20775578461532	3033	660/660	East
81910018	4.5" 6pk	770932040411	3490	24/24	East
81910026	5"	60775578460519	3090	320/320	East

Vented High Dome

Help maintain moisture for plants. Fits 10 x 20 tray. Adjustable sliding vent allows you to control humidity levels within the 6" H dome.



Item #	Desc	UPC	Vendor	CS/UOS	Location
81910047	6" 10x20	770932108005	3461	18/18	East

Professional Humidity Dome

Fits 10x20 greenhouse tray



Item #	Desc	UPC	Vendor	CS/UOS	Location
81910044	10x20	770932108098	4062P-A	48/48	East

Self Watering System Kit



Item #	Desc	UPC	Vendor	CS/UOS	Location
81910005	28-2.5" Coir Pots	770932002938	3459	6/6	East

Coir Pot Strips

Coir based growing containers are designed to offer you all the benefits of peat, without destroying our peat bogs. Much higher resistance to mold. Visibly better, faster plant growth. Containers won't fall apart when wet. Won't pull moisture away from plant.



Item #	Desc	UPC	Vendor	CS/UOS	Location
81910003	1.75" 50cells	770932004420	3450	24/24	East
81910004	2.5" 32cells	770932004413	3451	24/24	East

Coir Pellet Greenhouse Kit

The Jumbo 42mm Coconut Coir Pellets are perfect for all-purpose use and come with a professional greenhouse tray and a humidity dome.



Item #	Desc	UPC	Vendor	CS/UOS	Location
81910006	10-42mm plts	770932007070	3259	24/24	East

Coir Pellet

Coir pellets allow the root system to soak up more oxygen, liquid and nutrients compared to peat pellets.



Item #	Desc	UPC	Vendor	CS/UOS	Location
81910008	50-42mm coir pellet GH Kit	770932005816	3261	20/20	East
81910012	50-42mm coir pellet refill	770932043436	3492	12/12	East

Coir Pellet Bulk

Jumbo coconut coir pellets are dried and compressed in a biodegradable, fine-mesh netting. Pellets can be used to grow any seedlings or cuttings.



Item #	Desc	UPC	Vendor	CS/UOS	Location
81910013	1000 Pack 42mm	770932043412	3030	1/1000	East

PRO-MIX®

PRO-MIX Premium Organic Seed Starting Mix

OMRI-Listed and Ready-to-use, this peat-based organic seed starting mix is specially formulated with all natural ingredients. It's ideal for germinating, vegetable, flower, herb seeds as well as for starting leaf, stem or root cuttings. MycoActive™ Organic Growth Enhancer helps grow stronger roots, which leads to healthier plants with greater resistance to transplant shock.



Item #	Desc	UPC	Vendor	CS/UOS	Location
80310031	16 qt.	025849110413	1016041RGCE	210/6	East



Multipurpose Fabric Planter

Item #	Desc	UPC	Vendor	CS/UOS	Location
81110001	3 Gal	674344110031	11003	12/12	National
81110003	5 Gal	674344110055	11005	12/12	National
81110188	3 Gal w/ Handles	674344210038	21003	12/12	National
81110004	5 Gal w/ Handles	674344210052	21005	12/12	National

2025



African Violet Plus™ Liquid Plant Food 8-14-9

Promotes beautiful African violet blooms. Just 7 drops per quart of water. Package contains easy to use dropper and directions. Contains micronutrients.



Item #	Desc	UPC	Vendor	CS/UOS	Location
80050064	4 oz.	089146901068	SPF44900	12/12	National

7 Gallon Salad & Herb Grower w/ Cut Handles



Item #	Desc	UPC	Vendor	CS/UOS	Location
81110006	7 Gal w/ Handles	674344210076	21007	12/12	National
81110005	7 Gal	674344110079	11007	12/12	National

10 Gallon Pepper & Veggie Grower w/Cut Handles

Smart Pot® Fabric Planters help your plants thrive, promoting exceptional root health and vigorous plant growth for bigger, more abundant vegetables, flowers, plants, and herbs. Simply unfold, fill and start planting.



Item #	Desc	UPC	Vendor	CS/UOS	Location
81110008	10 Gal w/ Handles	674344210106	21010	12/12	National

Plant Food Plus™ 10-15-10

For all indoor and outdoor plants. Encourages new growth. Easy to use 7 drops per quart of water. Contains micronutrients and easy to measure dropper.



Item #	Desc	UPC	Vendor	CS/UOS	Location
80050063	8 oz.	089146901082	SPF45170	12/12	National

15 Gallon Potato & Squash Grower w/ Strap Handle

Smart Pot® Fabric Planters help your plants thrive, promoting exceptional root health and vigorous plant growth for bigger, more abundant vegetables, flowers, plants, and herbs. Simply unfold, fill and start planting.



Item #	Desc	UPC	Vendor	CS/UOS	Location
81110010	15 Gal w/ Handles	674344210151	21015	12/12	National



Raised Bed Planter

6 feet long x 16 inches wide x 16 inches tall; holds 10.7 cubic feet of soil or other planting mix



Item #	Desc	UPC	Vendor	CS/UOS	Location
81110137	6' Raised Bed	674344122065	12306	10/10	National

20 Gallon Tomato & Melon Grower w/ Strap Handle

Smart Pot® Fabric Planters help your plants thrive, promoting exceptional root health and vigorous plant growth for bigger, more abundant vegetables, flowers, plants, and herbs. Simply unfold, fill and start planting.



Item #	Desc	UPC	Vendor	CS/UOS	Location
81110012	20 Gal w/ Handles	674344210205	21020	12/12	National

Smart Pot Black Bulk

Soft sided fabric container. Multi purpose, aeration container for growing great plants. Provides root pruning. Excellent drainage & releases excess heat in hot weather for superb, fibrous root systems. For growing vegetables, flowers, herbs, and fruit. Lasts for years. Can be left outside all year long without worrying about winter damage.



Item #	Desc	UPC	Vendor	CS/UOS	Location
81110042	1 Gal	674344100018	10001	100/100	East
81110046	3 Gal	674344100032	10003	50/50	East
81110049	5 Gal	674344100056	10005	50/50	East
81110051	7 Gal	674344100070	10007	50/50	East
81110053	10 Gal	674344100100	10010	50/50	East
81110055	15 Gal	674344100155	10015	50/50	East
81110059	25 Gal	674344100254	10025	50/50	East



Soil Moist™ Plus 7-7-7

Contains the Soil Moist™ copolymer blended with a three to nine month timed release fertilizer. Ideal for indoor/outdoor plantings, especially in warmer, drier climates.



Item #	Desc	UPC	Vendor	CS/UOS	Location
80040017	8 oz.	030541010855	JCD-05SMP	12/12	National

Transplant Formula

Soil Moist Transplant is formulated to inoculate transplanted trees, shrubs and plants during planting time. The formulation contains a diverse blend of five species of healthy viable ectomycorrhizal propagules and seven species of endomycorrhizal propagules that are adapted to a wide range of plants. Soil Moist water storing polymers are included in the blend.



Item #	Desc	UPC	Vendor	CS/UOS	Location
80040210	3 oz. Bag (Retail Shelf Unit)	030541099829	JCD-TP03	24/24	National

Natural Formula

Soil Moist Natural is a grafted starch polymer designed to reduce plant waterings by 50% and last in the soil for an entire season. The organic starch in Soil Moist Natural is derived from corn. Soil Moist Natural is completely safe and biodegradable like our other Soil Moist polymer products. The product will hold several hundred times its weight in tap water and readily releases it back to the plant as the soil dries out. Ideal for hanging baskets, annual beds and vegetables.



Item #	Desc	UPC	Vendor	CS/UOS	Location
80040019	3 oz. Bag (Retail Shelf Unit)	030541777031	SMN3	24/24	National





Sunshine® Advanced Mix #4 with Resilience™

Recommended for indoor growing. This Myco-Active mix retains moisture while providing improved root aeration and drainage. This product contains Resilience™ for stronger stems and improved root mass.



Item #	Desc	UPC	Vendor	CS/UOS	Location
80320114	3 cu. ft.	064277310309	504500.CFC003P	35/35	National

Black Gold Seedling Mix

This highly refined, organic seedling mix is excellent for root growth in newly germinated seedlings, has low-salt, and is fine, yet porous and water-retentive. It has an organic wetting agent to ensure uniform water penetration. This product contains Resilience for stronger stems and improved root mass.



Item #	Desc	UPC	Vendor	CS/UOS	Location
80320031	8 qt	029973123332	1411002.Q08P	8/8	National
80320032	16 qt	029973123417	1411002.Q16U	4/4	National

2025



7" NanoDome

A lot of thought went into our 7" NanoDome. This is a high humidity vented dome that incorporates our ingenious light tracks. These tracks receive our T5HO Combo or LED strip lights. By placing your lighting in these tracks your plants receive the light they need. Fits 10" x 20" trays. Light & Tray not included.



Item #	Desc	UPC	Vendor	CS/UOS	Location
81740063	Nanodome	628836142321	1400232	25/25	National

Universal Strip Light Stand

The Universal Strip Light Stand allows you to set the exact lighting height to get your seedlings or fresh cuttings off to their best Starts ever. Simple adjustment makes setting the correct height quick and easy. As your seedlings or starts get growing you simply slide your lighting upwards to the desired height. Works with T5HO or LED Strip Lights.



Item #	Desc	UPC	Vendor	CS/UOS	Location
81740006	Stand only	62883609050	900095	1/1	National



Halo 360 LED Plant Light

Halo 360 LED Plant Light with USB adaptor and timer.



Item #	Desc	UPC	Vendor	CS/UOS	Location
80880270	360 LED plant light	638104030342	SL1036010	10/10	National



Nano Growlight Garden

Nano Growlight Garden with LED grow light timer & adaptor



Item #	Desc	UPC	Vendor	CS/UOS	Location
80880271	Nano Growlight	638104030359	SL1048199	6/6	National

Garden Grow Light

Perfect for growing herbs, salad & micro-greens. Want to get ahead start on next seasons seed starts? The Growlight Garden will get your favorite seeds started and ready to transplant quickly. Growlight Gardens come complete and ready-to-grow!

Item #	Desc	UPC	Vendor	CS/UOS	Location
81740077	Micro Black 18" x 8"	628836162183	SL1600218	1/1	National
81740078	Micro White 18" x 8"	628836162190	SL1600219	1/1	National
81740072	Larger LED version Black 24" x 16"	628836162008	SL1600200	1/1	National

T5HO Lighting Kit

The T5HO Light Kits come standard with a 6400K grow lamp, power-cord with on/off switch, 14" link cord, flush mount and hanging clips included.

This Kit is great for propagation of seedlings, cutting or getting your plants started right from seed. The 6400K grow lamp will also grow to finish many leafy green products, baby greens and all kinds of herbs.



Item #	Desc	UPC	Vendor	CS/UOS	Location
81740017	24" 24W	628836091728	SL0900172	6/6	National
81740019	48" 54W	628836091742	SL0900174	6/6	National

LED Strip Lights

SunBlaster LED Strip Lights are designed to maximize overall performance, economy, and extend longevity while providing the best possible lighting for all indoor growing applications without fail or compromise.

SunBlaster Strip Lights run virtually silent, and are mercury free. SunBlaster LED Strip Lights maximize their output without creating unwanted heat, or wasting valuable electronic resources.



Item #	Desc	UPC	Vendor	CS/UOS	Location
81740053	24" 24W 48 LEDs	628836097027	SL0900702	6/6	National
81740055	48" 48W 96 LEDs	628836097041	SL0900704	6/6	National

T5HO/LED - Mini Greenhouse Kits

Includes our 18 inch SunBlaster T5HO/LED Combo - light and reflector (not included with LED kit), 6400K Grow Lamp, Double Thick 1020 tray, and 7 inch NanoDome with ingenious light tracks. There simply is no better or faster way to get growing fresh micro-greens, herbs or seeds started ready for transplant.



Item #	Desc	UPC	Vendor	CS/UOS	Location
81740074	LED Kit	628836162046	SL1600204	1/1	National
81740075	T5HO Kit	628836162053	SL1600205	1/1	National

T5HO Combo's

SunBlaster T5HO Combos include our T5HO electronic ballast, 6400K lamp, power cord with on /off switch, and jumper plug with both hanging and flat surface mounting clips. Also included is the NanoTech T5 Reflector which spreads light wider across the plant canopy, penetrating deeper into the plant foliage, without consuming any additional power.



Item #	Desc	UPC	Vendor	CS/UOS	Location
81740038	24" 24W	628836093029	SL0900302	6/6	National
81740039	36" 39W	628836093036	SL0900303	6/6	National
81740040	48" 54W	628836093043	SL0900304	6/6	National

T5HO Replacement Lamp

SunBlaster T5HO replacement lamps are the right choice when re-lamping your T5HO lighting fixtures. We recommend changing your lamps 10,000 hours of operation to insure maximum growing performance and results from your T5HO lighting system.



Item #	Desc	UPC	Vendor	CS/UOS	Location
81740020	24 W	628836091759	0900175	6/6	East

1020 Double Thick Tray

HEAVY DUTY 1020 Propagation Trays. Twice the thickness of traditional trays! These trays are re-usable. These are industry standard size: 10" x 20".



Item #	Desc	UPC	Vendor	CS/UOS	Location
81740058	No holes	628836142208	SL1400220	50/50	National

1020 Quad Thick Tray

SunBlaster created the Worlds first Super Heavy Duty 1020 propagation tray to assist growers in achieving maximum output for their growing efforts.

This high quality injection molded tray is four times the thickness of industry standard 1020 trays.



Item #	Desc	UPC	Vendor	CS/UOS	Location
81740064	No holes	628836142352	SL1400235	25/25	National

2025

SUPERthrive



Superthrive Vitamin Solution

Superthrive is a highly concentrated non-toxic vitamin solution invigorating all variety of greenery for home gardeners and professionals alike. It is equally suited for hydro-seeding, hydroponics, and foliar spraying. Superthrive maximizes potential by quickly building a strong root base and reducing transplant shock.

Item #	Desc	UPC	Vendor	CS/UOS	Location
81870002	4 oz.	072532000148	ST4-12	12/12	National
81870003	1 pt.	072532000155	STPINT-12	12/12	National
81870004	1 qt.	072532000162	STQUART-12	12/12	National
81870005	1 gal.	072532000179	STGALLON-4	4/1	National

Plant Food 4-1-1

Certified organic, OMRI listed. Natural fish fertilizer that naturally breaks down & releases healthy nutrients into the soil. Grows bigger plants & blooms. Gentle on plants –won't burn eco-friendly; allows plants to take up more nutrients, reducing fertilizer run-off.



Item #	Desc	UPC	Vendor	CS/UOS	Location
81870069	32 oz	072532332089	STFOOD32-8	8/8	West



tdibrands
Terra-Devo International, LLC

Plant Alarm

Check moisture of indoor plants at root level not just at the surface. Inserts into the plant. On demand instant checking or continuous checking with a reminder to water. Red/Green easy to understand traffic light system. Flashes green every 30 min when the plant has optimum moisture. Flashes Red every 15 seconds when it requires watering. Prevents both over and under watering. 80% of plants die of overwatering. Attractive flower design. Very long battery life – 1 AAA will last over 3 years under normal use. Standard is designed for pots up to 7". Tall is Designed for pots up to 10".



Item #	Desc	UPC	Vendor	CS/UOS	Location
81552686	7.875" x 1.75" 1 lb. Standard Size	810146330257	1-1000	30/30	National
81552687	10.5" x 1.75" 1 lb. Tall Size	810146330264	1-1001	24/24	National

Plant Booster Grow Light

Boosts growth with 20 high intensity red/blue LEDs. 7W power, 400-700 nm Photosynthetic Active Radiation wavelengths. Blue light boosts foliage and ensures plants absorb more energy through the synthesis of chlorophyll stimulating germination, red light promotes flowering enhancing photosynthesis and red/blue combination speeds up growth. The base of the tripod is 7.25" tall. The adjustable neck is 13.25" and the LED light section is 5.5". 1 lb.



Item #	Desc	UPC	Vendor	CS/UOS	Location
81552689	White	810146330295	1-1003	12/12	National



Angled Marker

The Angled T-label is great for placing near or on the ground for easier viewing. Optional black base is also available and fits all T-label stems. Labels are made from UV protected recycled, consumer plastics.



*must order base separately

Item #	Desc	Vendor	CS/UOS	Location
82060018	2-1/2"	SL400W	50/50	National
82060023	3-7/8"	SL500W	25/25	National
82060027	Base	BASE	25/25	National



Plastic Labels

Labels are made from UV protected recycled, consumer plastics.



Item #	Desc	Vendor	CS/UOS	Location
82060028	4"	TY4W	1000/1000	National
82060031	5"	TY5W	1000/1000	National
82060039	6"	TY6W	1000/1000	National
82060040	8"	TY8W	500/500	National

Plastic Label Markers

T-Labels are designed for use where a larger label is needed. The Angled T-Label is great for placing near or on the ground for easier viewing. An optional black base is also available and fits all T-Label stems. Labels are made from UV protected recycled, consumer plastics



Item #	Desc	Vendor	CS/UOS	Location
82060004	3.5" x 2"	SL200W	100/100	National
82060011	3" x 4-1/4"	SL445W	50/50	National

Vinyl Loop Lock Labels



Item #	Desc	Vendor	CS/UOS	Location
82060046	White 5/8" x 6 1/2"	LL625W	1000/1000	National
82060047	Yellow 5/8" x 6 1/2"	LL625Y	1000/1000	National

Blackboard Label

These unique labels are ideal for marking sale items. Also a very economical style - use ordinary chalk or liquid chalk and simply wipe clean to re-use!



Item #	Desc	Vendor	CS/UOS	Location
82060057	4" x 6 3/8"	SL500BB	25/25	National



Black Sign Holder

Tyne classic black sign holders are made of a sturdy UV resistant, black plastic. Securely holds 11" x 7" or 5" x 7" signs in place. Angled Single Face style supports one sign in an upward facing position. Complete with 22" stem

Item #	Desc	Vendor	CS/UOS	Location
82060071	Angled single face 7"x5" with base & 22" stem	SL904	50/50	National
82060073	Angled single face 11"x7" with base & 22" stem	SL911	25/25	National
82060076	Cart clip on 11"x7" holder	SL605	25/25	National



Gardman Mini Greenhouses

Tiered mini greenhouses with reinforced poly covers.

Dimensions: A - 5'3" x 2'3" x 1'6" / B - 3'11" x 1'6" x 5'3"

7610- 4 tier comes with a reinforced cover. Metal tubular frame. Quality construction and materials to last many seasons. Heavy-duty reinforced polyethylene cover. Roll-up zippered door for easy access. (as shown in picture)

Item #	UPC	Vendor	CS/UOS	Location
81730004	A 745487976102	7610	1/1	East
81730003	B 745487976003	7600	1/1	National

2025



Perennials



Perennials



Sunny Annuals



Shade Annuals



Herb Garden



Vegetables



Poinsettias

Pre-designed Poster Options

- 2 sided printing on Coroplast
- Full color print
- UV coated
- Grommets for easy hanging (24x36)

16" x 24"

24" x 36"

Item	Description
PP-1623PE	Perennials
PP-1623PO	Poinsettias
PP-1623SH	Shade Annuals
PP-1623SU	Sunny Annuals
PP-1623VG	Vegetables
PP-1623HG	Herb Garden

Item	Description
PP-2436PE	Perennials
PP-2436PO	Poinsettias
PP-2436SH	Shade Annuals
PP-2436SU	Sunny Annuals
PP-2436VG	Vegetables
PP-2436HG	Herb Garden

POINT OF PURCHASE SIGNAGE

We make what you need. We offer complementary design services and a wide variety of sign options.

Don't see what you desire?
Call us at 419-666-3662 x 102.

FREE DESIGN WORK ON ALL CUSTOM ORDERS!

Custom Coroplast Posters

- Printed in UV cured ink/long-lasting durability
- Full color bleeds
- Durable high-quality outdoor 4mm coroplast
- Shipped within 5 days of proof approval
- Custom sizes available

Options

- Grommets in top corners - Free
- Double Sided - Additional cost, same as front or new image

Step stakes available
Item # PP-SS

Custom Vinyl Banners

- Printed in true digital color
- Full color bleeds
- Durable high-quality outdoor 13oz scrim vinyl
- Reinforced on all 4 sides with banner welding
- Drop-shipped within 5 days of proof approval

Options

- **Grommets (2-3')** - Free
- **Rope** - Additional cost
 - 500 pound nylon cord welded with 2' of slack
 - Location: top, bottom, top & bottom
- **Pole Pockets** - Additional cost
 - Size: 1, 2, 3, or 4" (Dimensions unchanged)
 - Location: top, bottom, top & bottom, left, right, left & right

Many other substrates available. **Contact Customer Service 800.888.0054**
Ask your sales person for more details.

SOILS, CONDITIONERS & GROUND COVER



CHECK OUT OUR CLEARANCE ITEMS!

DROP SHIP VENDORS

Sungro

All goods must be ordered in full pallets of a single sku
Full truckloads = 24 pallets; half truckloads = 12 pallets
Less than truckload orders will be accepted IF
matched and within a 75 mile range

There will be a \$125 drop off charge per stop for less
than truckload orders
Black Gold, Proven Winners Soils, Sunshine and Fafard
(where available) products can be combined on the
same truckload
Customer Pick up orders must be picked up within 2
weeks notice of availability

Espoma (Soil)

9 pallet minimum order, must be ordered in full pallet quantities
Full truckload = 18 pallets
\$75 stop-charge for LTL shipments
\$250 flatbed request charge

Premier

1 pallet minimum order
Truckload = 22 pallets +/- 2 pallets depending on weight.
Generally 24 pallets
Prepaid on full truckloads
Freight surcharge may be applicable
Product availability can take up to 10 days for
productions and up to 7 days for transportaion

Fertilome

Full truckload order is 22 +/- pallets
Partial load order is 12 pallets min and require a match, this
might cause delays
\$450 Drop Charge
Can be combined with Lambert

Fox Farm

Full truckload = 18 pallets
FOB Pendleton SC

Michigan Peat

Full truckload = 18 pallets
Half Truckload = 9 pallets
Prepaid freight on full truckloads and \$200 stop charge on half
load
3% pick up allowance
Please Refer to Zone Map for pricing

Lambert

Full truckload order is 22 +/- pallets
Partial load order is 12 pallets min and require a match,
this might cause delays
\$450 Drop Charge
Can be combined with Ferti lome

Old Castle

Half Truck Load
Full Truck Load
\$ 150 Drop Charge Zoned Ship Locations
Each Drop Ship must come from one location
Standard increase or decrease rules apply
Please Refer to Zone Map for pricing and Locations

Coast of Maine

Half truck load - 9-10 pallets
Full truck load - 18+ pallets
Half loads incur a \$75 drop charge and require a suitable
match
LTL is available for up to 6 pallets in van trailers
LTL surcharge is \$75 a pallet
Deliveries that require the use of a lift gate will be assessed a
\$75 fee per load
Customers may scheduled pickups with their own mode of
transportation
Customer is responsible for unloading with forklift (rated for
3,500 lbs) or accessible loading dock and pallet jack. No hand
unloading. If not, they will be charges \$100 per drop



Griffin Greenhouse Retail WAREHOUSE Shipping Map

We are now shipping nationwide!

NATIONAL



2025

Refer to location key:

National items are stocked nationally
 Select items are sold East or West only; no exceptions

8" Kaleidoscope Planter

Premium plastic modular planter can be displayed individually each planter has a removable saucer ideal for succulents or shallow rooted planted.

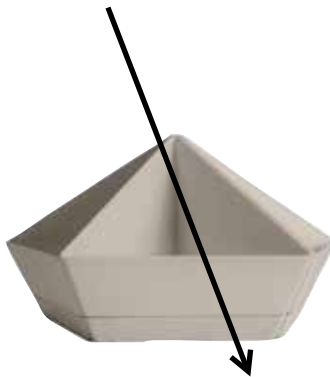

Item #	Desc	UPC	Vendor	CS/UOS	Location
80282643	Vanilla Bisque	770932844170	KDP08000A58	6/6	National

Where is the pricing?

1. Scan QR code on Chapter Pages to see pricing on Griffins.com
2. Contact your Griffin Sales Representative
3. Call into Griffin Customer Service 800.888.0054





Better Grow® Orchid Moss

High quality, five-star rated, natural imported sphagnum moss. Maintains adequate moisture, inhibits bacterial growth, and reduces shock when re-potting seedlings. Attractive to use in a wide variety of containers and cedar baskets. May also be used as a mounting medium for ferns.

Item #	Desc	UPC	Vendor	CS/UOS	Location
81830008	Brick	079925050452	50450	12/12	East

Better Grow® Orchid Bark

Specially sized grower's grade choice western fir bark. Quality potting mixture for all epiphytic orchids as well as a variety of ornamentals, such as bromeliads. Ideal for potting, re-potting, spot refilling, or as the base for a custom mixture. Comes in a handy re-sealable bag.

Item #	Desc	UPC	Vendor	CS/UOS	Location
81830004	4 qt.	079925050186	50180	15/15	East

Better Grow® Special Orchid Mix

A rich mixture of western fir bark, hardwood charcoal, and sponge rock to ensure healthy and long-lasting plants. Multi-purpose mixture that is appropriate for all epiphytic orchids. Provides your orchids with the drainage, air flow, and root ventilation they find and thrive on in nature. Comes in handy re-sealable bag.

Item #	Desc	UPC	Vendor	CS/UOS	Location
81830001	4 qt.	079925050001	50000	15/15	East

Coast of Maine

Topsoil

Topsoil is an economically priced blend of garden loam, compost, and sphagnum peat moss. Use for creating a base layer in raised beds, patching and filling holes in lawns.

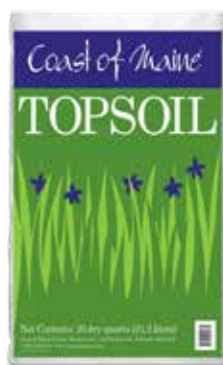

Item #	Desc	UPC	Vendor	CS/UOS	Location
81600154	20 qt.	609853000670	TO3500	75/75	East

Premium Leaf Compost

A natural material composed of recycled composted leaves and grass clippings. The end product is a dark, partially decomposed humus, similar to the natural organic matter found on the forest floor. Use to restore organic material to the soil when planting trees and shrubs, establishing a lawn, and in garden and flower bed preparation.



Item #	Desc	UPC	Vendor	CS/UOS	Location
81600064	.75cf	783293003049	LC3001	75/5	East

Premium Mushroom Compost

This compost is sourced in the mushroom capital of the world, Avondale, PA and made from recycled mushroom growing media, providing a great source of organic matter. The result is a dark, rich compost that is ideal for all of your garden or lawn needs.



Item #	Desc	UPC	Vendor	CS/UOS	Location
81600065	.75cf	783293003056	MC3001	75/5	East

Enriching Mulch with Kelp Fundy

Coast of Maine Fundy Blend Enriching Mulch with Kelp is the ideal top-dressing for roses and perennials. We combine some of our limited supply of very old, humified birch and maple bark with partially humified hemlock bark and a very rich blend of kelp solids and sphagnum moss peat. The result is an almost black humus that is rich in organic matter with all the added benefits of both compost and kelp.



Item #	Desc	UPC	Vendor	CS/UOS	Location
81600023	1 cf	609853000184	FU1000	80/8	East
81600022	2 cf	609853000498	FU2000	40/4	East

Enriching Mulch Dark Harbor

Dark Harbor Blend Enriching Mulch is an exceptionally rich, naturally dark, fine textured blend of composted bark. It helps retain moisture and insulate the surface soil against temperature variations that can harm roots. Because it is composted, it will not rob the soil of nitrogen and can be dug into the beds in the fall to improve the organic content of the soil.



Item #	Desc	UPC	Vendor	CS/UOS	Location
81600021	1 cf	609853000177	DH1000	80/8	East
81600020	2 cf	609853000269	DH2000	40/4	East

Coast of Maine



Bar Harbor Blend™ Premium Potting Soil

Our great all-purpose potting soil is made with natural and organic ingredients such as lobster, kelp, compost, perlite, and sphagnum peat. It is designed for potting indoor and outdoor container plants. Water and fertilize less with this nutrient rich, compost based potting soil.



Item #	Desc	UPC	Vendor	CS/UOS	Location
81600011	8 qt.	609853000474	BH4501	200/6	East
81600008	1cf.	609853000481	BH1000	80/8	East
81600007	2cf.	609853000467	BH2000	48/4	East

Cobscook Blend™ Organic & Natural Garden Soil

A compost-based premium soil for in-ground gardening. Made with a blend of salmon and blueberry compost mixed with aged bark, sphagnum peat moss, and horticultural limestone. It conditions the soil, retains moisture and also works well with acid-loving plants like azaleas, rhododendrons, holly, pieris and blueberry bushes.



Item #	Desc	UPC	Vendor	CS/UOS	Location
81600004	1 cf.	609853000047	CO1000	80/8	East
81600003	2 cf.	609853000276	CO2000	48/4	East

Castine Blend™ Organic & Natural Raised Bed Mix

An enriched blend of fully cured, locally-sourced compost, peat, biochar, worm castings, dehydrated poultry manure, kelp meal, lobster meal, greensand, lime, and mycorrhizae. Great for growing healthy vegetables, herbs, and flowers.



Item #	Desc	UPC	Vendor	CS/UOS	Location
81600084	1 cf.	609853000993	CA1000	80/8	East
81600061	2cf.	609853000931	CA2000	48/4	East

Schoodic Blend™ Organic & Natural Composted Manure Blend



For those who prefer traditional manure composts. This is an all-purpose soil conditioner designed for gardens, beds and borders. Made with a blend of composted cow manure from several local beef and dairy farms, and sphagnum peat moss. OMRI Listed.

Item #	Desc	UPC	Vendor	CS/UOS	Location
81600005	1 cf.	609853000252	SC1000	80/8	East

Lobster Compost Quoddy

Coast of Maine Quoddy Blend Lobster Compost is our best-selling soil, made with chitin and calcium-rich lobster shells, compost and peat humus. The result is a dark-brown, complex soil that drains well and is ideal for conditioning beds and borders, vegetable gardens, herbs and annuals!



Item #	Desc	UPC	Vendor	CS/UOS	Location
81600001	1 cf.	609853000221	QD1000	80/8	East

Penobscot Blend™ Organic & Natural Planting Mix

Penobscot Blend Organic & Natural Planting Mix is perfect for bedding annuals and planting perennials, roses, shrubs, and trees. This specially crafted soil amendment is enriched with compost, oyster shells, and root-enhancing mycorrhizae. Penobscot Blend provides your beds with the diverse, in-ground living soil, drainage, and aeration that your bushes, saplings, plants, and flowers need to flourish all season long. Contains Mycorrhizae.



Item #	Desc	UPC	Vendor	CS/UOS	Location
81600002	1 cf.	609853000030	PE1000	80/10	East

Aeration Formula

This 70/30 Coir and Perlite mix has been an industry staple for growers for years. The coir is made from the pith of coconut husks, an alternative to peat-based medias, and is combined with perlite for better aeration and drainage, allowing growers and gardeners to more aggressively feed without worrying about overwatering.

Item #	Desc	UPC	Vendor	CS/UOS	Location
81600198	1.5 cf.	609853002058	SA1500	60/6	East



Coast of Maine

Monhegan Blend™ Organic & Natural Black Earth Lawn Soil

An exceptional organic compost-based top soil, designed for top-dressing and repairing lawns, as well as general purpose use around the garden. Made with a blend of composts and sphagnum peat moss, it will retain moisture in order to facilitate grass seed germination. OMRI Listed.



Item #	Desc	UPC	Vendor	CS/UOS	Location
81600006	1 cf.	609853000245	MO1000	80/8	East

Wiscasset Blend™ Earthworm Castings

Gardeners have long known that there's magic in worm castings. Use to enrich potting soil with active biology and plant ready minerals or top-dress your indoor container plants to give them a boost. Castings can also be brewed into a quick compost tea by mixing with water, molasses and aerating overnight.



Item #	Desc	UPC	Vendor	CS/UOS	Location
81600014	8 qt.	609853000603	WI4501	4/4	East

Planting Soil for Annuals

Organic and natural planting soil for annuals is formulated for colorful, vibrant annuals like zinnias, dahlias, salvias, pansies, and more. This specially crafted compost blend helps balance moisture retention and drainage for growing in-ground and container annuals. Ideal for garden beds, borders, hanging baskets and containers.



Item #	Desc	UPC	Vendor	CS/UOS	Location
81600217	8 qt.	609853001006	AP3500	240/4	East

Mount Desert Island Blend™ Organic Cactus & Succulent Mix

Designed for cactus, succulents, tropical palms, and citrus plants. This pH balanced formula is made from: sphagnum peat moss, compost, sand, aged bark, biochar, fish bone meal, and kelp meal. It is ready-to-use and offers both excellent drainage and sufficient water retention. It is the perfect blend to promote root and plant growth.



Item #	Desc	UPC	Vendor	CS/UOS	Location
81600086	8 qt.	609853001006	MD4501	240/4	East

Organic & Natural Planting Soil for Roses & Flowers

The ideal planting mix to improve and revitalize the soil in and around all of your rose varieties, flowering annuals, and perennials. Perfect for supporting continual blooms and healthy foliage. Made with premium ingredients, it contains compost, sphagnum peat moss, aged bark, and lime.



Item #	Desc	UPC	Vendor	CS/UOS	Location
81600117	20 qt.	609853002027	RF3500	100/10	East

Organic & Natural Planting Soil for Tomatoes & Vegetables

The optimal soil conditioner to revitalize the soil in and around your vegetable garden beds. It is naturally lightweight and contains just the right ingredients to grow plentiful, flavorful tomatoes and vegetables. Made with premium ingredients, it contains compost, lobster, sphagnum peat moss, and lime.



Item #	Desc	UPC	Vendor	CS/UOS	Location
81600119	20 qt.	609853002003	TV3500	100/10	East

Organic & Natural Planting Soil for Acid Loving Plants

The ideal planting mix to improve and revitalize the soil in and around plants that thrive in lower pH soils like rhododendrons, azaleas, hollies, blueberries, strawberries, ferns, fuchsias, camellias, dogwoods, and conifers. Made with premium ingredients, it contains compost, sphagnum peat moss, and aged bark.



Item #	Desc	UPC	Vendor	CS/UOS	Location
81600118	20 qt.	609853002010	AL3500	100/10	East

Indoor Houseplant Mix

Specially formulated for indoor houseplants and flowers using coarse coconut coir, perlite, sphagnum peat moss, and aged bark to optimize drainage and aeration for robust root development. Whether you are growing peace lilies, spider plants, philodendrons, monsteras, or other popular or exotic houseplants, this unique compost-free blend provides the optimum structure and benefits for nurturing strong, beautiful indoor plants and flowers.



Item #	Desc	UPC	Vendor	CS/UOS	Location
81600208	8 qt.	609853002096	HP4501	200/6	East
81600209	16 qt.	609853002102	HP4502	120/4	East

2025



Exotic Blend® Cactus & Succulent Potting Mix

A perfect blend of soil that provides the best life for your succulents and cacti. This blend has excellent drainage and water holding capabilities simultaneously. Cactus, succulents and all drought tolerant plants will enjoy a home in our mix specially designed for their needs.



Item #	Desc	UPC	Vendor	CS/UOS	Location
81160232	4qt	749688008150	815	12/12	West
81160231	6qt	749688008167	816	8/8	West
81160226	8qt	749688008105	810	4/4	West
81160229	12qt	749688008174	817	1/1	West

Total Advantage® Rose & Flower Fertilizer 4-6-2

Dr. Earth® Total Advantage® Rose & Flower Fertilizer is formulated to feed flowering plants naturally to promote bigger and more abundant blooms. Great for all roses, flowers, flowering trees, shrubs as well as annuals & perennials.



Item #	Desc	UPC	Vendor	CS/UOS	Location
81160208	4lb	749688405102	702p	12/12	West



Premium Gold® All Purpose Fertilizer 4-4-4

Premium Gold® All Purpose Fertilizer produces remarkable results. Nutrients are released immediately and over several months. Premium formula provides optimum nutrition. Plants don't lie – it's great for every plant in the garden!



Item #	Desc	UPC	Vendor	CS/UOS	Location
81160200	4lb	749688916875	706p	12/12	West

All Purpose Potting Soil

Pot of Gold is recommended for use in all container planting or as a soil amendment for planting of trees, shrubs, bare root, flowers, and vegetables. TruBiotic technology ensures drought tolerance, enhanced nutrient availability and increased plant performance. It contains no synthetic ingredients or chicken manure. Sustainably made in the U.S.A.



Item #	Desc	UPC	Vendor	CS/UOS	Location
81160299	4qt	749688008181	818	12/12	West

Spectacular® Bulb Food Fertilizer 3-14-2

Spectacular® dry fertilizer is formulated for tubers, edibles, and ornamentals. Use on summer and winter crops – containerized or in-ground. For best results, use during initial planting and re-apply on a regular basis.



Item #	Desc	UPC	Vendor	CS/UOS	Location
81160204	4lb	749688828093	700p	12/12	West

Home Grown Tomato Vegetable & Herb Fertilizer 4-6-3

Home Grown fertilizer is formulated to feed tomatoes, vegetables and herbs, summer and winter crops. It is a 100% Natural & Organic hand crafted blend made from premium feed grade ingredients enriched with organic nutrients found in land and ocean plants, fish, fish bones & mined minerals. It is infused with TruBiotic, our beneficial soil microbes & mycorrhizae package that contributes to drought tolerance, enhanced nutrient availability & increased performance.



Item #	Desc	UPC	Vendor	CS/UOS	Location
81160196	4lb	749688122085	704p4	4/4	West
81160195	8lb	749688122085	704p	12/12	West

Root Zone® Starter Fertilizer 2-4-2

Root Zone® fertilizer is formulated to feed all transplants, vegetable garden plants, both summer and winter plants, in containers or in native soil found in your yard. It is best used when planting seeds or transplanting anything into a new container or at home in the garden.



Item #	Desc	UPC	Vendor	CS/UOS	Location
81160202	4lb	749688100106	701p	12/12	West

Natural Wonder® Fruit Tree Fertilizer 5-5-2

Natural Wonder® fertilizer is formulated to feed all fruit trees, berries, and fruiting vines in containers or any backyard soils. It can be used during the initial transplanting after digging the hole or anytime of the year to feed actively growing fruit trees and vines.



Item #	Desc	UPC	Vendor	CS/UOS	Location
81160198	4lb	749688717922	708p	12/12	West

Pelletized Soil Acidifier Plant Food Fertilizer

It is a great source of sulfur which promotes dark green growth and is ideal for all acid loving plants, lawns, evergreens, trees and vegetables. It is effective in helping to turn hydrangeas blue. The pelletized granule form makes it easy to handle and easier to break down in the soil.



Item #	Desc	UPC	Vendor	CS/UOS	Location
81160117	6lb	749688079921	7992	4/4	West

Pelletized Garden Lime Plant Food Fertilizer

Pelletized Garden Lime helps to raise the pH in soils to aid plants in maximizing nutrient intake. Great source of calcium and magnesium which are important nutrients for plant growth and health. Ideal for for vegetable and flower gardens and is effective in helping to turn hydrangeas pink. The pelletized form makes it easy to handle and easier to break down in the soil.



Item #	Desc	UPC	Vendor	CS/UOS	Location
81160118	6lb	749688079938	7993	4/4	West

FIRE GLASS COLLECTION

Decorative Glass used most commonly as planter toppers, floral arrangements, terrariums and indoor glassware.

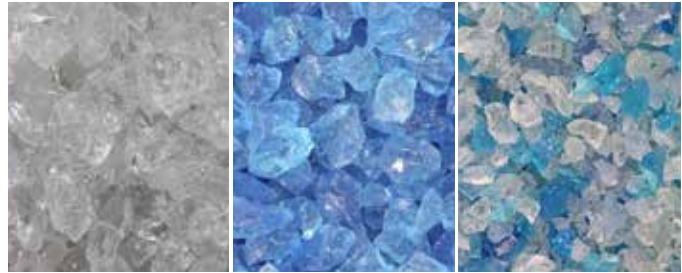

Ice Clear Glass

Turquoise Glass

Bahama Blend Glass



Amber Glass

Cobalt Blue Classic Glass

Ice Clear Glass

Item #	Desc	UPC	Vendor	CS/UOS	Location
82510002	1.5lb 1/4"-1/2"	855420008040	EP-G-01	12/12	West

Turquoise Glass

Item #	Desc	UPC	Vendor	CS/UOS	Location
82510003	1.5lb 1/4"-1/2"	855420008057	EP-G-04	12/12	West
82510056	12lb 1/2"-3/4"	855502005905	EFG-C04M	2/2	West

Bahama Blend Glass

Item #	Desc	UPC	Vendor	CS/UOS	Location
82510004	1.48lb 1/4"-1/2"	855420008088	EP-G-08	12/12	West
82510059	12lb 1/2"-3/4"	855502005943	EFG-C08M	2/2	West

Amber Glass

Item #	Desc	UPC	Vendor	CS/UOS	Location
82510060	12lb 1/2"-3/4"	855502005950	EFG-C12M	2/2	West

Cobalt Blue Classic Glass

Item #	Desc	UPC	Vendor	CS/UOS	Location
82510061	12lb 1/2"-3/4"	855502005813	EFG-C13M	2/2	West



POLISHED COLLECTION



Black Gravel

Black Pebbles



Jade Pebbles

Mixed Gravel

2025

Polished Black Gravel

Item #	Desc	UPC	Vendor	CS/UOS	Location
82510009	5.5lb Jar	855420008132	PBS-0510J	6/6	West

Polished Black Pebbles

Item #	Desc	UPC	Vendor	CS/UOS	Location
82510010	5lb Jar	855420008149	PBS-1030J	6/6	West

Polished Jade Pebbles

Item #	Desc	UPC	Vendor	CS/UOS	Location
82510014	5lb Jar	855420008187	PJS-1030J	6/6	West

Polished Mixed Gravel

Item #	Desc	UPC	Vendor	CS/UOS	Location
82510011	5lb Jar	855420008156	PMS-0510J	6/6	West

White Decor Sand

Exotic Pebbles decor Sand is perfect for use in terrarium, air gardens, floral decorations, and much more. 1.5 Lb. Jar



Item #	Desc	UPC	Vendor	CS/UOS	Location
82510001	1.5lb Jar white	855335007466	EP-R-40-10C	12/12	West

NATURAL COLLECTION

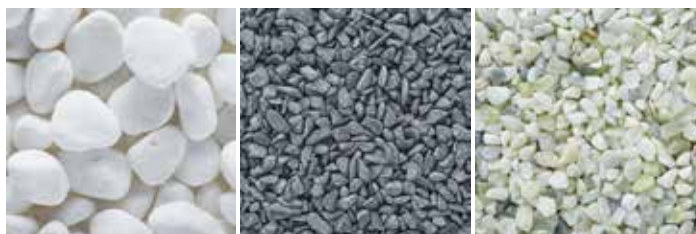

Snow White Pebbles

Black Bean Pebbles

Jade Bean Pebbles



White Bean Pebbles

Wood Bean Pebbles

Black Lava Pebbles

Snow White Pebbles

Item #	Desc	UPC	Vendor	CS/UOS	Location
82510015	5lb Jar	855420008194	PSW-0510J	6/6	West

Black Bean Pebbles

Item #	Desc	UPC	Vendor	CS/UOS	Location
82510005	5lb Jar	855420008095	BPBS-460J	6/6	West

Jade Bean Pebbles

Item #	Desc	UPC	Vendor	CS/UOS	Location
82510007	5lb Jar	855420008118	BPJS-464J	6/6	West

White Bean Pebbles

Item #	Desc	UPC	Vendor	CS/UOS	Location
82510006	5lb Jar	855420008101	BPWS-461J	6/6	West

Wood Bean Pebbles

Item #	Desc	UPC	Vendor	CS/UOS	Location
82510008	5lb Jar	855420008125	BPWS-468J	6/6	West

Black Lava Pebbles

Item #	Desc	UPC	Vendor	CS/UOS	Location
82510062	12lb	855502005974	EFG-L1030	2/2	West
82510052	50lb	689076151542	NL-3050	1/1	West



REFLECTIVE FIRE GLASS COLLECTION

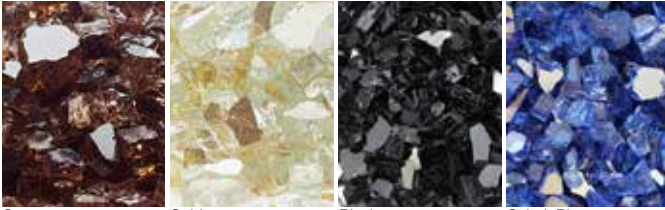

Copper Reflective Glass Gold Reflective Glass Black Reflective Glass Cobalt Blue Reflective Glass

Copper Reflective Glass

Item #	Desc	UPC	Vendor	CS/UOS	Location
82510071	12lb 1/2"-3/4"	855502005806	EFG-R01M	2/2	West

Gold Reflective Glass

Item #	Desc	UPC	Vendor	CS/UOS	Location
82510076	12lb 1/2"-3/4"	855502005851	EFG-R06M	2/2	West

Black Reflective Glass

Item #	Desc	UPC	Vendor	CS/UOS	Location
82510073	12lb 1/2"-3/4"	855502005820	EFG-R03M	2/2	West

Cobalt Blue Reflective Glass

Item #	Desc	UPC	Vendor	CS/UOS	Location
82510072	12lb 1/2"-3/4"	855502005813	EFG-R02M	2/2	West



Earthworm Castings

Use both indoors and outdoors. For roses, flowers, vegetables, trees, shrubs & houseplants. **Not For Sale GA**



Item #	Desc	UPC	Vendor	CS/UOS	Location
80030140	4 qt.	050197713047	EC4	12/12	National

Bonsai Mix

Elevate your bonsai gardening experience with Espoma Organic Bonsai Mix. This premium organic blend is specially formulated to provide the ideal growing conditions for your prized bonsai trees. **Not For Sale CA, UT**



Item #	Desc	UPC	Vendor	CS/UOS	Location
80030213	4 qt.	050197718042	BO4	12/12	National

Organic Cactus Mix

A rich, premium blend of sphagnum peat moss, peat humus, sand and perlite that has been enriched with Myco-tone®. Provides optimum aeration and drainage for cactus, palm and citrus plants. Improves moisture retention. Reduces drought stress and promotes root growth. **Not For Sale HI**



Item #	Desc	UPC	Vendor	CS/UOS	Location
80030209	4 qt.	050197703048	CA4	12/12	National
80030208	8 qt.	050197703086	CA8	6/6	National

Organic Perlite

All natural, 100% pure product. Loosens soils and prevents compaction. Aerates soil and promotes root growth. Great for improving heavy soils and can be used for cuttings



Item #	Desc	UPC	Vendor	CS/UOS	Location
80030039	8 qt.	050197707084	PR8	6/6	National

Organic Moisture Mix

All moisture potting mix with coir Myco-tone for bigger blooms better drought resistance. Enhanced with coir absorbs more water. Protects against over and under watering. Premium blend, natural and organic. **Not For Sale HI**



Item #	Desc	UPC	Vendor	CS/UOS	Location
80030143	8 qt.	050197712088	MM8	6/6	National
80030142	1cf.	050197712019	MM1	75/1	East

Organic African Violet Mix

A rich, premium blend of sphagnum peat moss, peat humus and perlite. Improves aeration and moisture retention. For African violets and other house plants. Promotes root growth.



Item #	Desc	UPC	Vendor	CS/UOS	Location
80030027	4 qt.	050197702041	AV4	12/12	National



Organic Orchid Mix

Improves drainage & aeration for orchids, epiphytes and bromeliads.



Item #	Desc	UPC	Vendor	CS/UOS	Location
80030096	4 qt.	050197704045	OR4	12/12	National

Organic Horticultural Charcoal

Espoma Organic Charcoal is an all-natural high carbon material that can help improve soils. It is produced by heating untreated hardwoods to very high temperatures without oxygen in a process called pyrolysis. The result is an excellent soil conditioner for improving potting mixes and adding better drainage in containers. **Not For Sale UT**



Item #	Desc	UPC	Vendor	CS/UOS	Location
80030216	4 qt.	050197719049	HC4	12/12	National

Peat Moss

All natural sphagnum peat moss. Improves aeration & moisture retention. Great for improving heavy soils.



Item #	Desc	UPC	Vendor	CS/UOS	Location
80030098	8 qt.	050197706087	PTM8	6/6	National

Organic Garden Soil

A rich, premium blend of the finest natural ingredients. It contains sphagnum peat moss, peat humus, and earthworm castings to help loosen heavy soil. Also enriched with Myco-tone®, our proprietary blend of 11 strains of endo and ecto mycorrhizae. Perfect for in-ground plantings and raised beds. **Not For Sale AL, AZ, HI, NV, NM, NC**



Item #	Desc	UPC	Vendor	CS/UOS	Location
80030128	All-Purpose 1 cu. ft.	050197711012	APGS1	75/5	East
80030129	Garden Soil 1 cu. ft.	050197710015	VFGS1	75/5	East



Organic Potting Mix

A rich, premium blend of sphagnum peat moss, peat humus and perlite that has been enriched with Myco-tone® and fortified with worm castings. For all indoor and outdoor containers. **Not For Sale HI**

Item #	Desc	UPC	Vendor	CS/UOS	Location
80030029	4 qt.	050197701044	AP4	12/12	National
80030040	8 qt.	050197701082	AP8	6/6	National
80030001	16 qt.	050197701167	AP16	120/5	East
80030002	1 cu. ft.	050197701013	AP1	75/5	East
80030013	2 cu. ft.	050197701020	AP2	48/6	East

Organic Raised Bed Mix

Organic Raised Bed Mix is fortified with worm castings, alfalfa, kelp and feather meal. Help builds strong roots. Use for in-ground plantings. Enhanced with Myco-tone. Used for raised bed planting. This product is formulated from 55% to 65% aged forest products, Canadian sphagnum peat moss, perlite, limestone to adjust pH, alfalfa meal, kelp meal, feather meal, earthworm castings and yucca extract. **Not For Sale AL, AK, AZ, HI, IA, MD, NV, NM, NC**

Item #	Desc	UPC	Vendor	CS/UOS	Location
80030198	1.5 cu. ft.	050197714013	RB15	60/10	East

Organic Land & Sea Compost

Espoma Organic Land & Sea Gourmet Compost is the ultimate compost mix to use for planting vegetables, flowers, trees and shrubs. It contains a rich blend of the finest natural ingredients and is enhanced with crab & lobster shells from the sea along with Myco-tone, our proprietary blend of mycorrhizae, to help build strong roots and better plants. **Not For Sale AL, AK, AZ, CA, HI, IA, MD, NV, NM, NC**

Item #	Desc	UPC	Vendor	CS/UOS	Location
80030199	1 cu. ft.	050197715010	LSC1	75/5	East

Mushroom Compost

Espoma Organic Mushroom Compost Blend is the ultimate compost mix to use for planting vegetables, flowers, trees and shrubs. It combines rich mushroom compost with aged forest products to make the perfect soil conditioner. These fine ingredients come together to create a high quality finished compost. **Not For Sale AK, AZ, CA, CO, HI, ID, MT, NV, NM, OR, UT, WY**

Item #	Desc	UPC	Vendor	CS/UOS	Location
80030201	.75cf	050197717755	MC75	75/75	East



Garden Gypsum

An all natural mineral that can help loosen clay soils, minimize salt damage to plants, and help promote root growth. Pelletized for easy application. Helps cure turf burns from ice-melters and pets.

Not For Sale NV

Item #	Desc	UPC	Vendor	CS/UOS	Location
80030079	6lb.	050197022064	GG6	6/6	National
80030078	36lb.	050197022361	GG36	1/1	National

Organic Soil Acidifier

The finest, most effective soil acidifier available. It contains all natural minerals that can be used to correct the problem of alkaline soil. Lowers the pH of soils for optimum growth of acid-loving plants. Provides fast acting and long lasting source of sulfur. Turns hydrangeas blue.

Item #	Desc	UPC	Vendor	CS/UOS	Location
80030030	6 lb.	050197030069	GSUL6	6/6	National

Organic Garden Lime

The finest grade of pelletized, dolomite limestone available. It can be used anywhere in the garden and landscape where a higher (less acidic) soil pH is desired. It adjusts soil pH so plants are able to make the most of the fertilizer you apply.

Item #	Desc	UPC	Vendor	CS/UOS	Location
80030223	5lb.	050197020053	GL5	12/12	National



African Violet Mix

Formulated with a peat blend that provides good air capacity and water retention. It is an excellent mix for African Violets but it's also indicated for all the plants of the Gesneriad family such as Streptocarpus, Episcias and Gloxinias.



Item #	Desc	UPC	Vendor	CS/UOS	Location
82280375	4 qt.	066498099476	LP6649809947	12/12	East

Orchid Mix

a blend of sphagnum peat chunks, red bark, hardwood charcoal, and volcanic lava rock combined to create an environment that will prevent the roots from being kept too wet while providing humidity. Excellent drainage and secure anchoring for the roots makes this long-lasting mix ideal for your orchids.



Item #	Desc	UPC	Vendor	CS/UOS	Location
82280380	4 qt.	066498098271	LP6649809827	12/12	East

Cactus Mix

This coarse mix, with granite sand and extra perlite, duplicates conditions found in arid environments. This heavyweight potting mix performs well under low water application. For use on cactus and succulents



Item #	Desc	UPC	Vendor	CS/UOS	Location
82280377	4 qt.	066498099377	LP6649809937	12/12	East
82280376	16 qt.	066498099391	LP6649809939	70/10	East

Horticultural Charcoal

A filter to absorb impurities in water and improve air quality. It is excellent as a layer in the bottom of containers and in terrariums where water may pool. Charcoal also can help absorb impurities in fertilizer.



Item #	Desc	UPC	Vendor	CS/UOS	Location
82280378	4 qt.	066498099773	LP6649809977	12/12	East



Succulent Mix

The perfect ready to use potting mix for all your favorite succulents. The Blend of sphagnum peat, EcoPeat*, and perlite will ensure maximum porosity, superior drainage and ideal water retention.



Item #	Desc	UPC	Vendor	CS/UOS	Location
82280386	4 qt.	066498099346	LP6649809934	12/12	East
82280385	8 qt.	066498099353	LP6649809935	6/6	East

Perlite Mix

These lightweight particles increase aeration and decrease water holding when incorporated into soil. Add to potting mixes for extra drainage for water-sensitive succulents and cacti.



Item #	Desc	UPC	Vendor	CS/UOS	Location
82280381	8 qt.	066498099551	LP6649809955	6/6	East

Organic Canadian Sphagnum Peat Moss

Ready to use, pre-moist loose filled peat moss. It is offered in an easy to carry 8 quart size for the convenience of the consumer. As the larger bale sphagnum peat moss this product is pre-screen and stick free.



Item #	Desc	UPC	Vendor	CS/UOS	Location
82280358	8 qt.	066498099858	LP6649809985	6/6	East

Vermiculite Mix

The mineral Mica, super-heated to expand much like an accordion. This mineral is other used in soil mixes to increase water holding capacity. Many growers use vermiculite in their flats in order to create a micro environment that will protect seeds from air currents and insulate the seeds to provide uniform germination temperatures.



Item #	Desc	UPC	Vendor	CS/UOS	Location
82280387	8 qt.	066498099650	LP6649809965	6/6	East

Decorative Sphagnum Moss

Provides a long cut, fibrous material. Great for decorative floral arrangements. Superior water holding capacity.



Item #	Desc	UPC	Vendor	CS/UOS	Location
82280379	8 qt.	066498098158	LP6649809815	6/6	East

Organic Garden Soil

A blend of supercharged Black Peat with humic and fulvic acids, worm castings and kelp meal. The best garden conditioner substitute for sphagnum peat moss for square foot gardens. Perfect for flowers, vegetables and herbs.



Item #	Desc	UPC	Vendor	CS/UOS	Location
82280370	2.0 cf	664980097922	LP6649809792	65/10	East

Compressed Peat

Sphagnum Peat Moss adds body to thin and sandy soils and aerates heavy and sandy soil. The soil ammendment also reduced erosion and fertilizer leaching and protects soil from drying and hardening.



Item #	Desc	UPC	Vendor	CS/UOS	Location
82280355	3 cf	064277124081	LP6649803175	35/8	East



ferti-lome®



Ultimate Potting Mix

All purpose mix ideal for outdoor and indoor plants.

Item #	Desc	UPC	Vendor	CS/UOS	Location
82280364	8 qt.	066498099056	LP6649809905	6/6	East
82280363	25 qt.	664980099018	LP6649809901	91/10	East
82280362	50 qt.	066498099025	LP6649809902	65/10	East

Organic Seed & Cutting Mix

Ideal starter for germinating seeds and rooting leaf, stem, and root cuttings. The sphagnum peat blend with a wetting agent provides an excellent balance between moisture retention and air capacity to prevent root disease while promoting efficient rooting.



Item #	Desc	UPC	Vendor	CS/UOS	Location
82280384	4 qt.	066498097984	LP6649809798	12/12	East

Organic Potting Mix

This rich potting mix includes Mycorrhizae, worm castings, and humic acids. A slow release organic fertilizer and added moisture control helps keeps plants healthy over time. Many uses indoors or outdoors, including seed germination, potted plants, hanging baskets, and container gardens.



Item #	Desc	UPC	Vendor	CS/UOS	Location
82280367	8 qt.	066498097960	LP6649809796	6/6	East
82280366	40 qt.	0664980097953	LP6649809795	75/10	East

Organic Raised Bed Mix

A formulated blend of Canadian sphagnum peat moss, EcoPeat®, shrimp flour, and seaweed extract that provides extended release of organic nutrition. Suitable for all types of organic raised bed gardening, it supports an excellent ratio of drainage and water retention.



Item #	Desc	UPC	Vendor	CS/UOS	Location
82280368	40 qt.	066498098059	LP6649809805	75/10	East



Happy Frog Soil Conditioner

In every bag of Happy Frog® Soil Conditioner you'll find finely-screened aged forest products, earthworm castings, and bat guano, not to mention soil microbes to help increase root efficiency and encourage nutrient uptake. FoxFarm also adds humic acids, which may increase the uptake of important micronutrients. **Not For Sale AK, HI, ME, PR, VI, WI**



Item #	Desc	UPC	Vendor	CS/UOS	Location
82000174	1.5 cu ft	752289590047	HFSC1.5E	75/5	National
82000154	3.0 cu ft	752289590030	HFSC3.0	35/5	West

Happy Frog Potting Soil

Happy Frog® Potting Soil is designed for container planting. Whether you're growing a ficus in the dining room, a geranium on the patio, or a lemon tree on the deck, use Happy Frog Potting Soil in your containers. For additional nutrition, blend in our Happy Frog® Fruit & Flower Fertilizer. Then sit back and enjoy the results. **Not For Sale HI**



Item #	Desc	UPC	Vendor	CS/UOS	Location
82000152	12qt	752289590016	HF12QTE	120/10	National
82000153	2cf EAST	752289590023	HF2.0E	60/6	East
82000224	2cf WEST	752289590023	HF2.0W	48/6	West



Ocean Forest Potting Soil

FoxFarm's most popular potting soil, Ocean Forest® is a powerhouse blend of aged forest products, sphagnum peat moss, earthworm castings, bat guano, fish meal, and crab meal. **Not For Sale PR**

Item #	Desc	UPC	Vendor	CS/UOS	Location
82000167	12 qt	752289790041	OF12QTE	120/10	National
82000168	1.5cf EAST	752289790058	OF1.5E	75/5	East
82000223	1.5cf WEST	752289790058	OF1.5W	64/8	West
82000164	3.0 cu ft	752289690044	OF3.0E	36/6	National



Coco Loco Potting Mix

Plants growing in Coco Loco® will not require water as often as your usual potting mix. Whether you're growing in hanging baskets, vertical gardens, containers, or seedling trays, extend your watering schedule. In most climates, every two to three days will be enough. Always adjust your watering schedule as needed. **Not For Sale HI**



Item #	Desc	UPC	Vendor	CS/UOS	Location
82000156	2 cf	752289591020	CL2.0E	48/6	National
82000219	12qt	752289591075	CL12QTE	120/10	National

Light Warrior Potting Soil

Light Warrior® Seed Starter is designed to promote an environment beneficial to seed germination and root development. Light Warrior Seed Starter includes soil microbes that can help enhance root efficiency and encourage nutrient uptake. FoxFarm has also included earthworm castings, a gentle source of nutrition for seedlings and small plants. Use Light Warrior Seed Starter for seed germination, cuttings and new plant starts for both indoor and outdoor cultivation. **Not For Sale HI**



Item #	Desc	UPC	Vendor	CS/UOS	Location
82000169	1.0 cu ft	752289790096	LW1.0E	75/5	National

Strawberry Fields Fruit & Flower Potting Soil

Strawberry Fields® Fruiting & Flowering Potting Soil is designed to pump up your blooms, fruits and berries with no hang-ups. Brought to you directly from the Flower Children of the Sixties and Seventies—the Old School generation. Love, Peace and Happiness is in our hearts and that is exactly what we pour into every bag of Strawberry Fields®. Out-A-Sight!



Item #	Desc	UPC	Vendor	CS/UOS	Location
82000158	1.5 cu ft	752289591044	SF1.5E	75/5	National

Original Planting Mix

Original Planting Mix is a blend of soil amendments such as aged forest products, sphagnum peat moss and earthworm castings. Use our Original Planting Mix for all your gardening projects. The aged forest products and peat moss in FoxFarm Original Planting Mix may make it more effective at holding moisture around the roots of plants.



Item #	Desc	UPC	Vendor	CS/UOS	Location
82000166	1.0 cu ft	752289790010	PM1.0E	75/5	National

Cultivation Nation Seventy Thirty

Cultivation Nation® Seventy Thirty Growing Media is a mixture of buffered coconut coir and perlite, blended in the classic ratio of 70:30. Coconut coir is known for its water holding capabilities, and perlite is included to provide air spaces in the media, facilitating aeration and drainage. Cultivation Nation® Seventy Thirty Growing Media is great for use with customized feeding schedules in indoor and outdoor containers. **Not For Sale AK, CA, DC, HI, MD, NY, VI, WI**



Item #	Desc	UPC	Vendor	CS/UOS	Location
82000220	2.0 Cu Ft	752289690068	CN70302.0E	48/1	National

Salamander Soil Potting Mix

Seedlings and plants will have access to the benefits of a potting mix full of nutritious properties. Plants that are grown in hot climates need that extra thirst quench so that they can stay vigorous and not get stressed from drying out. We have created water holding salamander soil so that your plants can moisturize in the same way as this special animal. **Not For Sale AK, HI, ME, PR, SD, VI, WI**



Item #	Desc	UPC	Vendor	CS/UOS	Location
82000160	1.5 cf	752289591105	SAL1.5E	75/5	National



Cocoa Shell Mulch

An organic mulching material made from the outer shell of the cocoa bean. Shells breaks down slowly and will not disappear into the soil. Helps reduce weeds, conserves water, insulates in the winter and adds nutrition to the soil, it will not burn vegetation. Natural color and pleasing cocoa aroma.



Item #	Desc	UPC	Vendor	CS/UOS	Location
82340001	2 cu ft	096852215874	CS2CF	60/60	East



GardenMAX™ Soil Treatment

You need to try GardenMAX! This is the best all-natural soil treatment for gardens and flowerbeds! GardenMAX contains organic material and restores the pH balance to your soil with over 50 all-natural ingredients! Take control over your garden & flowerbeds and build healthy soil. GardenMAX is much more than a fertilizer! It's a complete formula that transforms your soil into a place plants and trees love to grow!



Item #	Desc	UPC	Vendor	CS/UOS	Location
82710013	37lb	852932007011	GMX-ST37-055	55/1	West

TURFMAX Soil Treatment

TurfMAX Soil Treatment for Lawns treats and corrects over a dozen different components of a healthy soil to create a place where your lawn loves to grow! Used for new plantings or tough problem spots, TurfMAX transforms your soil into a healthy living soil that helps your lawn thrive. Powered by BioLife Complex which targets depleted and declining landscapes to revitalize the natural growth cycle.

Beneficial microbes, trace elements, pH conditioners, and more, restore the natural balance of life in the soil to transform the places you love into the places grass loves to grow.



Item #	Desc	UPC	Vendor	CS/UOS	Location
82710010	37lb	753182276687	TMX-ST37-055	55/1	West

Fruit & Veggie Planting Mix

Artisan Organics™ Fruit & Veggie Planting Mix by Green As It Gets™ is especially designed and hand-crafted for organic gardening. It contains NO Synthetics, NO Pesticides, and NO Artificial Ingredients and is certified organic by the OMRI.



Item #	Desc	UPC	Vendor	CS/UOS	Location
82710016	1 cf	852932007387	PLMX-FV-1.0CF	70/1	West



Premium Worm Castings

Want to start your garden off right with fertile, rich soil? Add Pride Lands Worm Castings to your soil before planting, as a soil top dress, or mix into compost tea to give plants a potent boost of essential nutrients. Worm castings are a gentle fertilizer, nurturing a potent mix of beneficial fungi, bacteria and organic matter in the soil which in turn creates a bountiful garden. A staple for any garden, worm castings can be added as a top dressing, soil additive, or compost tea ingredient at any point in a plant's life cycle.



Item #	Desc	UPC	Vendor	CS/UOS	Location
82850056	4lb	857834003000	PWC-4	10/10	West

Earthshine Biochar

Want to breathe new life into used soil? Using ancient secrets from the Terra Preta soils that nurture the mighty Amazon rainforest, Earthshine brings any old dirt back to life so it can properly nurture your plants. Full of all natural premium ingredients and based on biochar which, like the rainforest, sequesters carbon, this potent soil amendment makes it possible to reuse old, spent soil. Earthshine can be used as a top dressing at any point in the life cycle, used with soilless media, or mixed into compost tea.



Item #	Desc	UPC	Vendor	CS/UOS	Location
82850011	2lb	857834003017	ES-3002	8/8	West
82850012	5lb	857834003031	ES-3005	4/4	West

GreenGro Water Filter

REMOVES CHLORINE & HEAVY METALS: Carbon eliminates gasses, oils, debris, chemicals, and other volatile organic pollutants; Premium KDF prevents bacteria growth even when not in use; Makes water safe for kids, adults, pets, and plants. **PROTECTS YOUR PLANTS & GARDEN:** Eliminates aggressive chemicals that burn the roots of your plants, kill the microorganisms that help them absorb the greatest amount of nutrients; Helps maintain healthy living soil; Helps plants produce thriving fruits and veggies. **HEALTHIER & CLEANING DRINKING WATER:** Protects against fungus; Eliminates mold and water discoloration; Carbon eliminates odor and bad taste in drinking water; Soft and silky water feeling. **BUILT TO LAST:** Large capacity filtration; Withstands hard water flows and long sunlight periods; Easy installation, cleaning, and use; Made in USA; To expand lifetime, remove it before a freeze. **MULTIPURPOSE FILTER:** Fits any standard 5/8" water or garden hose; Great for RVs, hot tubs, boats, pools, spas, ponds, and campers.



Item #	Desc	UPC	Vendor	CS/UOS	Location
82850047	Water Filter	860009387096	GGWF	12/12	West



Green Aminos

Want to maximize the effectiveness of your nutrients and your plants' absorption abilities right from the start? GreenGro Green Aminos provides an essential blend of amino acids that support strong roots and plant growth throughout the life cycle. Whether you use Green Aminos in a rooting solution, watered into soil or as a foliar feed, you can be assured your plants are receiving optimal nutrition from premium natural ingredients. Give your garden the head start it needs with Green Aminos.



Item #	Desc	UPC	Vendor	CS/UOS	Location
82850058	2lb	850050414162	C.Top-GA	6/6	West

Pride Lands Defense

Want to give your soil a defensive barrier of protection against common pests? Pride Lands Defense is the ultimate repellent to keep mites, fungus gnats, thrips, root aphids and all soil-dwelling insect larvae out of your garden. Unlike harsh chemical pesticides, our formula uses quality organic ingredients that prevent pests from ever considering your plants a target and gives your soil a protective barrier against infestations. Simply sprinkle as a top dressing onto your soil or soil-less growing medium and scratch into the surface. Shield your plants from pests with Pride Lands Defense.



Item #	Desc	UPC	Vendor	CS/UOS	Location
82850064	2lb	850050414247	H&G PLD-002	10/10	West



Perlite

Harris Perlite is ideal for promoting root growth and healthy soil in container plants. pH Neutral, non flammable, non toxic, and insect and fungus resistant. Will not shrink or decay overtime. Helps soil to retain moisture and nutrients while preventing root compaction.



Item #	Desc	UPC	Vendor	CS/UOS	Location
82770113	8qt Dry	072725011401	PERL-8	4/4	National



Garden Gypsum

Loosens clay soils, allowing air and water to penetrate. Improves drainage and helps fertilizer work better. Natural materials won't upset soil pH.



Item #	Desc	UPC	Vendor	CS/UOS	Location
80070036	5 lb.	071605170054	17005	9/9	East

Cactus & Succulent Soil Mix

Professionally formulated for use with both jungle and desert cacti. Provides the drainage cacti need to flourish. Ready-to-use; pH balanced. Encourages bloom and root development. Complete package directions provide useful growing information.



Item #	Desc	UPC	Vendor	CS/UOS	Location
80070004	4 qt.	071605104042	10404	12/12	East
80070005	10 qt.	071605104103	10410	5/5	East

Organic African Violet Soil Mix

Provides the optimum growing medium for all types of African violets. Light and loose, encourages healthy foliage and beautiful blooms.



Item #	Desc	UPC	Vendor	CS/UOS	Location
80070001	4 qt.	071605103014	10301	12/12	East

Organic Special Orchid Mix

Provides optimum growth for epiphytic orchids. Provides proper drainage orchids require for development and growth. Premixed, ready to use. Ideal for repotting.



Item #	Desc	UPC	Vendor	CS/UOS	Location
80070006	4 qt.	071605108040	10804	12/12	East
80070007	8 qt.	071605108088	10808	6/6	East



Alabaster Blend Stone Chips

Clean, white, marble chips. Not dusty.



Item #	Desc	UPC	Vendor	CS/UOS	Location
80070090	2 qt.	071605141023	14102	6/6	East

Blue Magic Aluminum Sulfate

Acidifying soil conditioner. Makes hydrangeas blue! Perfect for all acid loving plants.



Item #	Desc	UPC	Vendor	CS/UOS	Location
80070070	4 lb.	071605665055	66505	12/12	East

Volcanic Lava Rock

A great decorative moisture retainer for potted or bedded plants.



Item #	Desc	UPC	Vendor	CS/UOS	Location
80070088	Red 2 qt.	071605144024	14452	10/10	East
80070157	Black 2 qt.	079925050001	50000	10/10	East

Bonsai Soil Mix

Provides optimum growth for evergreen and other bonsai plants. Provides the plant support, moisture and drainage bonsai need. Premixed, ready to use. Excellent for repotting.



Item #	Desc	UPC	Vendor	CS/UOS	Location
80070003	2 qt.	071605107081	10708	10/10	East

Marble Maze River Gravel

Pea sized Chesapeake yellow river gravel. Multiple uses indoor & outdoor.

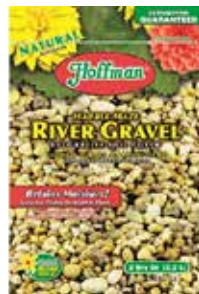

Item #	Desc	UPC	Vendor	CS/UOS	Location
80070089	2 qt.	071605142020	14202	6/6	East

Charcoal Soil Conditioner

Use this Hoffman Charcoal Soil Conditioner to improve the soils texture, density, aeration and drainage. Charcoal can absorb excess moisture as well as remove odors. It is very effective in sweetening soils in terrariums and pots that lack appropriate drainage and need improved root oxygen levels. Comes in a quick zip resealable bag.

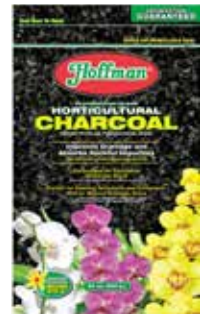

Item #	Desc	UPC	Vendor	CS/UOS	Location
80070035	24oz	071605175028	17502	12/12	East

Organic Cow Manure (1-1-1)

Adds all natural nutrients to soil to help produce healthy growth. Helps build humus content and improves overall soil texture. Non-burning, safe, easy-to-apply. Encourages earthworm activity.



Item #	Desc	UPC	Vendor	CS/UOS	Location
80070060	4 lb.	071605210040	21004	10/10	East
80070061	20 lb.	071605210200	21045	120/10	East

Purely Organic Potting Soil

Ideal for repotting plants, window boxes, outdoor containers and hanging baskets. Contains a wetting agent to maintain moisture levels.



Item #	Desc	UPC	Vendor	CS/UOS	Location
80070008	4 qt.	071605125047	12504	12/12	East
80070009	8 qt.	071605125085	12508	6/6	East
80070011	16 qt.	071605125160	12520	4/4	East
80070013	1 cu. ft.	071605125016	12501	80/5	East



West Coast Fir Bark

An attractive miniature bark that is aromatic and clean.



Item #	Desc	UPC	Vendor	CS/UOS	Location
80070087	2 qt.	071605145021	14552	10/10	East

Horticultural Vermiculite

Soil conditioner that loosens soil, provides aeration and retains water. Can be used to start seeds, propagate cuttings and store bulbs. Blend with peat moss and perlite for custom soilless mix.



Item #	Desc	UPC	Vendor	CS/UOS	Location
80070050	8 qt.	071605160024	16002	6/6	East
80070051	18 qt.	071605160048	16004	4/4	East
80070052	2 cu. ft.	071605160178	16045	60/1	East

Horticultural Perlite

Lightweight soil conditioner that loosens clay soil, reduces caking and improves drainage and aeration. Can be used to start seeds, propagate cuttings and store bulbs. Blend with peat moss and vermiculite for custom soilless mix.



Item #	Desc	UPC	Vendor	CS/UOS	Location
80070047	8 qt.	071605165029	16502	6/6	East
80070048	18 qt.	071605165043	16504	4/4	East
80070049	2 cu. ft.	071605165173	16545	60/1	East

All Purpose Potting Mix Plus

Ideal for repotting plants, window boxes, outdoor containers and hanging baskets. Contains a wetting agent to maintain moisture levels.



Item #	Desc	UPC	Vendor	CS/UOS	Location
80070020	4 qt.	071605123043	12304	12/12	East
80070014	10 qt.	071605123104	12306	5/5	East
80070017	16 qt.	071605123166	12320	4/4	East

Western Desert Sand

Clean, washed silica sand. Excellent for formulating your own cactus soil. Mix with Garden Soil to create a loamy soil.



Item #	Desc	UPC	Vendor	CS/UOS	Location
80070086	2 qt.	071605143027	14302	6/6	East

Organic Canadian Sphagnum Peat Moss

Premium grade of coarse Canadian sphagnum peat moss. When mixed with soil, increases the soil's capacity to hold water and nutrients. Can be blended with perlite and vermiculite when custom soilless potting mix is desired.



Item #	Desc	UPC	Vendor	CS/UOS	Location
80070044	10 qt.	071605155037	15503	6/6	East
80070045	18 qt.	071605155068	15506	4/4	East

Pelletized Horticultural Lime

The dust free way to reduce soil acidity in lawns and flower and vegetable gardens. Easy to spread by hand or spreader. Stays where applied. Does not blow away.



Item #	Desc	UPC	Vendor	CS/UOS	Location
80070039	4 lb.	071605152043	15204	12/12	East

Organic Dehydrated Super Manure (4-2-3)

Dehydrated poultry manure in easy-to-apply pelletized form. Improves soil texture; builds humus content without burning. Produces outstanding results in flower and vegetable gardens, and lawns.



Item #	Desc	UPC	Vendor	CS/UOS	Location
80070063	5 lb.	071605205053	20505	9/9	East
80070064	20 lb.	071605205206	20545	120/10	East

Complete Potting Mix w/ Moisture Crystals

Complete Potting Mix with Moisture Crystals is specially formulated to optimize the water retention of the mix and to maintain good aeration for good plant growth.



Item #	Desc	UPC	Vendor	CS/UOS	Location
81940038	1 cu ft	006649809758	6649809758	91/10	East
81940039	2 cu ft	006649809759	6649809759	65/10	East

Sphagnum Moss

Used in the lining of wire frames and hanging baskets. It is used extensively by nurserymen for air layering. Some species of orchids, especially Phalaenopsis, are grown in large quantities using nothing but sphagnum moss.



Item #	Desc	UPC	Vendor	CS/UOS	Location
81940024	8 qt	066498075296	6649807529	6/6	East

Peat Moss



An excellent soil amendment because of its capacity to retain water, aerate the soil and it is completely natural. Lambert Peat Moss helps retain moisture, aerate soil, and provide organic matter for gardens and flower beds.



Item #	Desc	UPC	Vendor	CS/UOS	Location
81940029	1.0 cu ft	066498051153	06649805115	100/10	East
81940030	2.2 cu ft	066498041154	06649804115	50/50	East
81940032	3.8 cu ft	066498021156	06649802115	30/1	East

Orchids Mix

Blend of four components that provide many species of orchids an environment conducive for good root development. This mix also has more weight which aside from providing good anchorage of roots, also prevents the plants from easily being uprooted.



Item #	Desc	UPC	Vendor	CS/UOS	Location
81940022	4 qt	066498076170	6649807617	12/12	East



Professional Organic All Purpose Mix

This ready to use, environmentally friendly peat-based substrate promotes healthy and rapid plant growth for all your favorite flowers, vegetables, herbs, trees and shrubs.



Item #	Desc	UPC	Vendor	CS/UOS	Location
81940001	8 qt	066498064613	6649806460	6/6	East
81940040	16 qt	006649806463	6649806463	120/10	East
81940002	1.0 cu ft	066498064610	6649806461	90/10	East
81940003	2.0 cu ft	066498064627	6649806462	50/10	East

All Purpose Potting Mix

The ideal Ready-to-use media for all your indoor and outdoor growing needs versatile for various container types and sizes.



Item #	Desc	UPC	Vendor	CS/UOS	Location
81940012	4 qt	066498076002	6649807600	12/12	East
81940013	8 qt	066498076019	6649807601	6/6	East
81940041	16 qt	066498076064	6649807606	120/10	East
81940015	1.0 cu ft	06649807603	6649807603	91/10	East
81940016	2.0 cu ft	066498076040	6649807604	65/10	East

2025



Cactus & Succulents Mix

Provides plants a media that reproduces similar conditions one would find in an arid environment. The sand allows good drainage and weight. The peat provides organic matter to the plants.



Item #	Desc	UPC	Vendor	CS/UOS	Location
81940021	4 qt	066498076132	6649807613	12/12	East

Top Soil

Recommended for conditioning flower beds and vegetable gardens. It is made of dark composted peat, a nutrient source that promotes plant growth.



Item #	Desc	UPC	Vendor	CS/UOS	Location
81940036	25 L	006649806200	LP6649806200	105/105	East

Horticultural Vermiculite

An aggregate used to increase water retention in your potting mixes. It is very useful to cover germinating seeds. In fact, its water-holding properties and its considerable porosity aid in insulating the germinating seeds and protect them from drying out and from damaging air currents.



Item #	Desc	UPC	Vendor	CS/UOS	Location
81940026	8 qt	066498076255	6649807625	6/6	East

Gardening Soil For Flowers & Vegetables

The organic material in this soil helps improve aeration of clay soils and increases water retention in sandy soils. The peat moss can reduce the loss of fertilizer through leaching in addition to helping to protect the soil against drying and curing.



Item #	Desc	UPC	Vendor	CS/UOS	Location
81940009	1.5 cu ft	066498064306	LP6649806430	75/10	East

Horticultural Perlite

A good choice for plant lovers who wish to improve their potting mix drainage capacity. Perlite improves drainage in soils and is an excellent aggregate to root cuttings as it can be packed to hold a plant part in place until roots are initiated.



Item #	Desc	UPC	Vendor	CS/UOS	Location
81940025	8 qt	066498076217	6649807621	6/6	East

Trees & Shrubs Planting Mix

The texture of this soil will promote its soil incorporation. With its pH adjusted, this mix will loosen the soil and peat contained therein will promote adequate ventilation to improve root growth.



Item #	Desc	UPC	Vendor	CS/UOS	Location
81940011	1.5 cu ft	066498064405	LP6649806440	75/10	East

Horticultural Wood Charcoal

Filtration properties aid a media by purifying air and water. It is also used at the bottom of containers to aid in drainage of excessive water.



Item #	Desc	UPC	Vendor	CS/UOS	Location
81940023	4 qt	066498076194	6649807619	12/12	East

Potting Mix

This Potting Mix is a general purpose media with numerous applications for indoor and outdoor use such as hanging baskets and containers. It is a favorite amongst plant lovers. The adjusted pH combined with perlite promotes aeration, drainage and assimilation of nutrients that are essential for optimum plant growth. This media is easy to use as it has been pre-moistened.



Item #	Desc	UPC	Vendor	CS/UOS	Location
81940008	1.5 cu ft	066498064504	6649806450	75/10	East

Spanish Moss

Natural decorative product beautifies the appearance of baskets, planters, dish gardens, flower pots and artificial arrangements. Helps to retain moisture in containers and does not interfere with watering or fertilization.



Item #	Desc	UPC	Vendor	CS/UOS	Location
80130053	250 cu. in	010367005600	ML0560 8	8/8	East

Sheet Moss Soil Cover

Sheet moss is also ideal for arts and crafts. Our natural sheet moss is harvested on the floor of old growth forests. While we inspect and remove foreign material before packaging, it is a natural product and may contain traces of lichens, molds, and leaves that grow along with it.



Item #	Desc	UPC	Vendor	CS/UOS	Location
80130052	250 cu. in	010367004603	ML0560 8	8/8	East

Long Fibered Sphagnum Moss

Long fibered, fluffy and clean. Absorbs and retains up to twenty times its weight in water. Use for soilless gardening, transplanting, mulch and hanging basket filler. For soil mixes, it offers excellent root aeration. Also used for rooting bulbs and cuttings.



Item #	Desc	UPC	Vendor	CS/UOS	Location
80130014	432 cu. in.	010367001107	ML0110	12/12	East

Fibered Sphagnum Moss

Absorbs and retains up to twenty times its weight in water, twice as much as a cellulose sponge. Invaluable for soilless gardening, transplanting, mulch and hanging basket filler. For soil mixes, it offers excellent root aeration. Also used for rooting bulbs and cuttings. Long fibered sphagnum moss is not peat moss, but rather a perennial plant that grows wild in the central Wisconsin sphagnum bogs.



Item #	Desc	UPC	Vendor	CS/UOS	Location
80130019	2 BU	010367001206	120	1/1	East



Decorative Glass Gems

Mosser Lee's Glass Gems and Sea Glass are manufactured from high quality glass. The exceptional beauty and consistent size of the glass gems make them decorator essentials. The sea glass colors reflect the colors of the ocean with splashes of green, blue and clear. Hand packed in reusable plastic jars to insure high quality. Use for terrariums, dish gardens, vase filler and fairy gardens.

Item #	Desc	UPC	Vendor	CS/UOS	Location
80130026	2.2lb Tuscan Gems	010367021419	ML2141	8/8	East
80130027	2.2lb Elegant Blue Gems	010367021211	ML2121	8/8	East
80130028	2.2lb Crystal Gems	010367021310	ML2131	8/8	East

Sea Glass

Mosser Lee's Glass Gems and Sea Glass are manufactured from high quality glass. The exceptional beauty and consistent size of the glass gems make them decorator essentials. The sea glass colors reflect the colors of the ocean with splashes of green, blue and clear. Hand packed in reusable plastic jars to insure high quality.



Item #	Desc	UPC	Vendor	CS/UOS	Location
80130029	2.2lb	010367021518	ML2151	8/8	East

River Pebbles

There are many uses such as to retain moisture in plant soil, beautify indoor and outdoor containers, improve plant drainage, and create water and fountain designs. The small size is perfect for decoration and utility uses. These lightly polished stones can be used as a vase-filler for fresh or artificial arrangements. Perfect for terrariums and fairy gardens. They can be arrange in pots for.



Item #	Desc	UPC	Vendor	CS/UOS	Location
80130034	5lb.	010367021815	ML2181	8/8	East



Pearl Stone

Mosser Lee Pearl Stone represents the finest in quality rock bedding. The small particles are perfectly designed to loosen heavy soils and provide excellent bases for any gardening or craft project. Pearl Stones rich grey color and small dimension are designed for creative creations.

Item #	Desc	UPC	Vendor	CS/UOS	Location
80130005	5 lb	010367011229	ML1122	8/8	East

River Rock

Mosser Lee River Rock is drawn from the cold flowing rivers of the deep Wisconsin woods. Millions of years of rushing water have naturally polished the once sharp lines of this natural rock into the beautiful River Rocks that we offer to you.

Item #	Desc	UPC	Vendor	CS/UOS	Location
80130007	5 lb	010367011212	ML1121	8/8	East

White Marble

Mosser Lee Marble Nuggets come from volcanically created substrate pushed to the surface by the changing earths crust. Exposed marble, white from the mineral deposits, is mined and washed to create the perfect decorative stone.

Item #	Desc	UPC	Vendor	CS/UOS	Location
80130008	5 lb	010367011304	ML1130	8/8	East

Natural Pebbles

Mosser Lee's Natural Pebbles are an essential component for interior gardeners. Our pebbles are cleaned and carefully inspected to ensure product consistency. The raw natural-colored stones reflect the gentle washing action of flowing Wisconsin rivers.

Item #	Desc	UPC	Vendor	CS/UOS	Location
80130068	5 lb	010367011236	ML1123	8/8	East

River Gravel

Mosser Lee River Gravel is mined from river beds, dried by receding glaciers. Washed clean and tumbled by ancient rivers, these small stones moved down stream from the North.

Item #	Desc	UPC	Vendor	CS/UOS	Location
80130006	5 lb	010367011205	ML1120	8/8	East

Desert Sand

Mosser Lee Decorative Sands are selected especially for Mosser Lee for their luster. Mined from ancient sand pits and river beds, these sand products are the highest quality sands on the market.

Item #	Desc	UPC	Vendor	CS/UOS	Location
80130002	5 lb	010367011106	ML1110	8/8	East

Black Sand

Natural decorative product beautifies the appearance of baskets, planters, dish gardens, flower pots and artificial arrangements. Mined from ancient sand pits and river beds, these sand products are one of the highest quality sands on the market.

Item #	Desc	UPC	Vendor	CS/UOS	Location
80130001	5 lb	010367011120	ML1112	8/8	East

White Sand

Mosser Lee White Sand is used to retain moisture in plant soil, beautify indoor and outdoor container plants, improve plant drainage and create water and fountain designs. Ideal for terrariums, dish gardens and various craft and decorative uses.

Item #	Desc	UPC	Vendor	CS/UOS	Location
80130009	5 lb	010367011113	ML1111	8/8	East

Polished Stone

Polished Stones make an attractive soil cover for indoor and outdoor container plants, including bonsai, cacti, and others. Beautify and enhance your plants by adding a decorative top layer of Polished Stones to your planters and pots. Polished Stones are also ideal for terrariums, aquariums, water and dish gardens, fountains, clear vases, and various craft and decorative projects. The number of uses for these stones is only limited by your imagination.



Item #	Desc	UPC	Vendor	CS/UOS	Location
80130017	5lb	010367011601	ML1160	8/8	East

Mossify



REINDEER MOSS

Our Premium Reindeer Moss comes in five stunning shades of green. Perfect for adding a burst of colour to any DIY project. Reindeer Moss has a fresh, soft, and spongy texture, bringing a natural feel to your creations.

Lime Premium Reindeer Moss (A)

Item #	Desc	UPC	Vendor	CS/UOS	Location
82370077	Lime	660111997219	REIN-LM-0001	12/12	National

Pistachio Premium Reindeer Moss (B)

Item #	Desc	UPC	Vendor	CS/UOS	Location
82370078	Pistachio	660111997226	REIN-PI-0001	12/12	National

Mint Premium Reindeer Moss (C)

Item #	Desc	UPC	Vendor	CS/UOS	Location
82370079	Mint	660111997233	REIN-MT-0001	12/12	National

Shamrock Premium Reindeer Moss (D)

Item #	Desc	UPC	Vendor	CS/UOS	Location
82370080	Shamrock	660111997240	REIN-SH-0001	12/12	National

Kiwi Premium Reindeer Moss (E)

Item #	Desc	UPC	Vendor	CS/UOS	Location
82370081	Kiwi	660111997257	REIN-KW-0001	12/12	National

Preserved Moss

Preserved Moss is perfect for moss walls, moss decor, terrariums, lining baskets, moss art and much more. Preserved Moss is your choice if you want a more grassy & greener appearance above soil and around plant bases.



Item #	Desc	UPC	Vendor	CS/UOS	Location
82370038	50g	660111996892	PRES-G-0001	12/12	National

Spanish Moss

Spanish Moss is versatile, and unique type of Bromeliad that is widely used for decorative purposes because of its special look. Our Premium Spanish Moss will give a completely different look to your home decor, terrarium, and floral arrangement.



Item #	Desc	UPC	Vendor	CS/UOS	Location
82370037	75g	660111996885	SPAN-N-0001	12/12	National

Long Fiber Sphagnum Moss

With fibers ranging from 3" to 6", Mossify's reimagined Premium Long Fiber Sphagnum Moss is sustainably harvested from the pristine wetlands of Chile. This versatile moss is perfect for plant care, propagation, seed germination, reptile and amphibian habitats, and much more.



Item #	Desc	UPC	Vendor	CS/UOS	Location
82370035	50g	660111996861	SHAG-N-0001	12/12	National

Natural Forest Moss

This Forest Moss can come back to life in the right conditions. Enough water, sun and love and you will have beautiful live moss! This Hypnum moss species takes about 6 months to fully grow.



Item #	Desc	UPC	Vendor	CS/UOS	Location
82370036	75g	660111996878	FOR-N-0001	12/12	National

PROMIX

PRO-MIX All Purpose Mix

Ready-to-use, this peat-based mix is perfect for indoor and outdoor planting. Specially formulated for a wide range of plant species this mix offers ideal water holding, nutrient retention, and aeration properties. Plus the added benefit of MycoActive™ Organic Growth Enhancer, for guaranteed results!



Item #	Desc	UPC	Vendor	CS/UOS	Location
80310019	2 cu. ft. compressed	025849113308	1020030RG	50/5	East

PRO-MIX Organic Potting Mix

PRO-MIX has formulated this potting mix to be suitable for indoor and outdoor potting and re-potting plants in containers. It contains a slow release fertilizer that feeds for up to nine months and is formulated with a water-saving gel to hold extra water. This product is also ideal for all seed starting applications. Contains: Canadian sphagnum peat moss, water-absorbent polymer, perlite, limestone, slow release fertilizer, and wetting agent.



Item #	Desc	UPC	Vendor	CS/UOS	Location
80310071	1 cu. ft.	025849111113	1010011RG	120/10	East

PRO-MIX Premium Potting Mix

Ready-to-use, this peat-based mix is perfect for all indoor and outdoor container planting. Specially blended for a wide range of plant species, this formulation provides optimum aeration, drainage and nutrients and features MycoActive™ Organic Growth Enhancer to produce vigorous growth and healthy plants. Feeds up to 9 months. Formulated with water-saving gel to hold extra water.



Item #	Desc	UPC	Vendor	CS/UOS	Location
80310025	16 qt.	025849110109	1016010RGCE	210/6	East
80310017	1 cu. ft. loose fill	025849111106	1010010RG	120/10	East
80310018	2 cu. ft. loose fill	025849107109	1020010RG	54/54	East
80310053	2 cu. ft. compressed	025849003050	0305RG	35/35	East

PRO-MIX Organic Garden Mix

Formulated with natural ingredients. Ideal for raised bed and all outdoor planting needs. Compost-free organic material & mycorrhizae for plant health.



Item #	Desc	UPC	Vendor	CS/UOS	Location
80310072	1 cu. ft.	025849111212	1010021RG	120/10	East

PRO-MIX Premium Garden Mix

Perfect for planting in-ground outdoor plants as well as improving the quality of existing garden bed soil. It is specially formulated with a high percentage of peat humus and compost, making it the mix to use for plants that require more stability such as perennials and flowering shrubs. It also contains MycoActive™ Organic Growth Enhancer to produce vigorous growth and healthy plants. Loose fill.



Item #	Desc	UPC	Vendor	CS/UOS	Location
80310027	1 cu. ft.	025849111205	1010020RG	120/10	East
80310028	2 cu. ft.	025849107208	1020020RG	54/54	East

PRO-MIX Premium Organic Vegetable & Herb Mix

OMRI-Listed and Ready-to-use, this peat-based mix is perfect for all your vegetable, fruit, and herb garden needs, whether in-ground or in containers. It is specially formulated with an organic fertilizer that provides gradual feeding to your plants. The gypsum for amazing tomato growth, and MycoActive™ Organic Growth Enhancer helps produce greater yields and vigorous growth. Compressed bales expand to 4 cu. ft.



Item #	Desc	UPC	Vendor	CS/UOS	Location
80310013	1 cu. ft. loose fill	025849111519	1010051RG	120/10	East
80310014	2 cu. ft. loose fill	025849107512	1020051RG	54/5	East
80310054	2 cu. ft. compressed	025849002053	0205RG	35/5	East

PRO-MIX Premium Cactus Mix

Ready-to-use, this peat-based CACTUS MIX provides optimized air porosity and fast water draining qualities while maintaining adequate water retention for cacti and succulent needs. It also features MycoActive™ Organic Growth Enhancer to produce vigorous growth and healthy plants.



Item #	Desc	UPC	Vendor	CS/UOS	Location
80310035	8 qt.	025849109813	1008081RGCE	6/6	East

Sphagnum Peat Moss



Sphagnum peat moss is well suited for both indoor and outdoor applications. It conditions all soils by improving aeration and it is used as a soil amendment for gardens as well as preparation and restoration of lawns. Compressed bale.



Item #	Desc	UPC	Vendor	CS/UOS	Location
80310007	1CF Compressed	025849002626	0262P	100/10	East
80310001	2.2CF Compressed	025849001285	0128P	50/50	East
80310010	3.8 cu. ft.	025849000820	0082P	30/1	East



Tuper Mix

Tuper Mix is designed with the idea of feeding your plant as much and often as possible. Though not your typical 70/30 coco perlite blend, it is a blank slate to create your own high performance feeding regimen.



Item #	Desc	UPC	Vendor	CS/UOS	Location
82580010	1.76 cf		RG-TU176P	65/65	National

Kings Mix

Kings Mix is a well-aerated, moderately amended coco peat all purpose blend. Featuring coco chips, it's quick drying and encourages root development. Perfect for light deprivation, greenhouse, indoor, or outdoor gardens of any type.



Item #	Desc	UPC	Vendor	CS/UOS	Location
82580005	1.76 cf		RG-KM176P	65/65	National
82580006	3 cf		RG-KM30P	36/36	National

Planting Mix

Planting Mix finally answers the industry's demand for a high-quality, perlite-free soil option. Perfect as a standalone growing medium or for use in raised beds, amending native soils, revitalizing tired gardens, mulching, and even beautification projects, their Planting Mix does it all. Moderately amended with excellent permeability and moderate water retention, this is truly an all-purpose planting medium.



Item #	Desc	UPC	Vendor	CS/UOS	Location
82580031	1.5 cf		RG-PLT15P	60/60	National

Potting Mix

A fresh take on our tried-and-true peat-free formulation. Reformulated from their flagship Basement Mix, they have focused on creating a finer version of our classic recipe. By removing larger particles such as coco chips and lava rock and using their unique perlite formulation, they have made this a perfect fit for smaller propagation cells and flexible enough for a wide variety of crops and applications. Potting and Propagation Mix is perfect for seeds, clones, and all of your potting needs. Lightly amended with an excellent mix of air-holding and water-holding abilities, this potting soil's versatility shines through.



Item #	Desc	UPC	Vendor	CS/UOS	Location
82580030	1.5 cf		RG-POT15P	60/60	National



Cactus Gritty Soil Mix

Cactus Gritty Mix is the mix that started it all! This puts a more eco-friendly spin on the traditional gritty cactus soil by utilizing coconut chips and coir, an otherwise wasted byproduct of the coconut industry.



Item #	Desc	UPC	Vendor	CS/UOS	Location
82840012	2qt	850040662214	01-002-02	8/8	National

Bonsai Gritty Mix

Bonsai Gritty Mix is our fastest draining and least water-retentive product, ensuring that the hardiest of dry-weather plants stay happy and healthy. Containing pine bark as it's only organic component, the minimalist nature of Bonsai Gritty Mix is perfect for those who prefer a traditional bonsai mix or need a starting point for custom mixes of their own.



Item #	Desc	UPC	Vendor	CS/UOS	Location
82840016	2qt	850040662184	01-001-02	8/8	National

Houseplant Chunky Mix

The Houseplant Mix was designed to offer quality soil options for all types of plant lovers, not just those with cacti and succulents. This mix contains the most organic matter of all our products to ensure that your houseplants get all the moisture and nutrients they need to thrive. This mix utilizes recycled coconut chips and coir, an otherwise wasted byproduct of the coconut industry.



Item #	Desc	UPC	Vendor	CS/UOS	Location
82840002	2qt	850040662122	01-004-02	8/8	National

Succulent Gritty Mix

Succulent Gritty Mix is ideal for a wide variety of succulents and other dry-weather plants. It contains more organic matter and retains more moisture/nutrients than our cactus soil. This mix utilizes recycled coconut chips and coir, an otherwise wasted byproduct of the coconut industry.



Item #	Desc	UPC	Vendor	CS/UOS	Location
82840008	2qt	850040662153	01-003-02	8/8	National



Orchid Chunky Mix

Orchid Mix is designed to be extra light and avoid compaction to provide maximum oxygen to the root system, a must for these unique plants. As orchids typically are not found in the ground, they obtain water and nutrients from the air, rain, and debris that collects in the crevices in which they grow.



Item #	Desc	UPC	Vendor	CS/UOS	Location
82840020	2qt	850040662245	01-005-02	8/8	National

Biotics Repot Recovery

Sol Biotics lines are designed to give you options of a limited set of complimentary items to use all year round on all your plants without the worry of misusing them by accident and burning or hurting your plants.



Item #	Desc	UPC	Vendor	CS/UOS	Location
82840049	0.2lb	850041000000	04-002-01	20/20	National



Leca Balls

LECA (Lightweight Expanded Clay Aggregate) is becoming one of the most popular and versatile substances in horticulture. As a soil component or medium, it retains moisture while providing excellent drainage for excess water. Use as a soil topper for a unique desert or Martian theme!



Item #	Desc	UPC	Vendor	CS/UOS	Location
82840032	2qt	850040662016	03-002-02	8/8	National

Pumice

Pumice (filtered 3/8" to 1/4" in size) is relatively lightweight volcanic rock used as an amendment in all types of soil. Its porous composition allows it to retain moisture and nutrients during watering, and release them slowly over time as the root system requires. Think of these components as little batteries for your plants!



Item #	Desc	UPC	Vendor	CS/UOS	Location
82840036	2qt	850040662276	03-003-02	8/8	National

Topper Original

The Original Sol topper blends grey, gold, and red rock to create a unique and colorful landscape. Toppers serve as a protective layer against bugs and other pests, as well as a decorative flair for your favorite plants.



Item #	Desc	UPC	Vendor	CS/UOS	Location
82840023	1qt	850040662092	02-001-01	16/16	National

Topper Kona Grey

The Kona Grey topper is comprised of the finest St. Cloud grey granite. Toppers serve as a protective layer against bugs and other pests, as well as a decorative flair for your favorite plants.



Item #	Desc	UPC	Vendor	CS/UOS	Location
82840025	1qt	850040662078	02-002-01	16/16	National

Topper Saharan Gold

Saharan Gold topper features beautiful yellow (intentionally) acidic variant of limestone, inspired by the golden hues of the Sahara Desert. Toppers serve as a protective layer against bugs and other pests, as well as a decorative flair for your favorite plants.



Item #	Desc	UPC	Vendor	CS/UOS	Location
82840029	1qt	850040662030	02-004-01	16/16	National

Topper Sedona Red

The Sedona Red topper features sparkling pink quartz, evoking the famous reds of the American Southwest. Toppers serve as a protective layer against bugs and other pests, as well as a decorative flair for your favorite plants.



Item #	Desc	UPC	Vendor	CS/UOS	Location
82840027	1qt	850040662054	02-003-01	16/16	National



Just Coir

Just What The Name Implies, Just Coir, actually coconut coir pith, highest quality coir available, rinse it to reduce salts & then reconstitute it from an awkward difficult to use compressed bale into a more user friendly ready to use product.



Item #	Desc	UPC	Vendor	CS/UOS	Location
80320007	2 cf.	064277065209	1491302.CFL002P	40/40	National

African Violet Mix

Picky African violets thrive in this blend of peat moss, compost, perlite/pumice and earthworm castings. African Violet Mix maintains a good balance between porosity and organic matter for happy, blooming plants with beautiful foliage. It is also suited to Gloxinia, Sinningia, Streptocarpus and other gesneriads and sensitive container plants.



Item #	Desc	UPC	Vendor	CS/UOS	Location
80320002	8 qt.	064277124081	1410502.Q08P	8/8	National



Earthworm Castings



This enriching soil amendment is great for use as a top-dressing or can be added to water to make a rich "casting tea."

Item #	Desc	UPC	Vendor	CS/UOS	Location
80320008	8 qt.	064277322166	1490302.Q08P	4/4	National

Waterhold Cocoblend Potting Mix



Contains Resilience™ for stronger stems and improved root mass. Gives your outdoor container plants the advantage of water retention against constant exposure to heat, wind and sun. Also contains earthworm castings and perlite or pumice to make soil a high-performance growing medium for all your gardening applications. Does not contain copolymer crystals (polyacrylamide).

Item #	Desc	UPC	Vendor	CS/UOS	Location
80320030	2 cu. ft.	064277169204	1402030.CFL002P	40/40	West

2025

All Purpose Potting Soil with Resilience™

Nutrient-rich blend of peat moss, earthworm castings, compost and perlite/pumice is great for indoor and outdoor container plantings. It provides superior moisture retention, excellent drainage and is specially formulated with a controlled release fertilizer that feeds plants for up to six months. This potting soil contains Resilience™ for stronger stems and improved root mass.

Item #	Desc	UPC	Vendor	CS/UOS	Location
80320013	8 qt.	064277123084	1410102.Q08P	8/8	National
80320015	16 qt.	064277123169	1410102.Q16U	120/4	National
80320016	1.0 cu. ft.	064277123107	141010-CFL001P	70/70	National
80320018	2.0 cu. ft.	064277123206	1410102-CFL002P	40/40	National

Cactus Mix

A fast-draining medium formulated for succulent plants, Black Gold® Cactus Mix is the first step in creating your own garden oasis. It contains a balanced blend of perlite/pumice, earthworm castings and compost to encourage healthy growth while ensuring ample aeration and drainage that most cacti, bromeliads and succulents require to thrive.

Item #	Desc	UPC	Vendor	CS/UOS	Location
80320003	8 qt.	064277124807	1410602.Q08P	4/4	National
80320043	1cf	029973133690	1410602.CFL001P	63/63	West

Canadian Sphagnum Peat Moss Plus

With all the benefits of peat moss plus an added organic wetting agent, Black Gold® Peat Moss Plus is comprised of 100% Canadian sphagnum peat moss, the best all-purpose natural soil conditioner. It is particularly suited to acid-loving plants and can slightly lower the pH of more alkaline soils.

Item #	Desc	UPC	Vendor	CS/UOS	Location
80320005	8 qt.	064277124821	1410403.Q08P	8/8	National

Perlite



Used to improve the drainage and aeration of any growing medium, perlite is a lightweight, expanded volcanic rock. Its high porosity also makes it suitable for rooting cuttings. Wet before using to prevent airborne dust.

Item #	Desc	UPC	Vendor	CS/UOS	Location
80320035	8 qt.	029973123494	1490102.Q08P	8/8	National

Natural & Organic Potting Soil w/ Resilience™

Made from the finest ingredients and OMRI Listed for organic gardening, it is recommended for containers and raised beds. Enriched with earthworm castings, it contains a mix of peat moss and compost in addition to perlite and pumice to ensure good aeration. This product contains Resilience™ for stronger stems and improved root mass.



Item #	Desc	UPC	Vendor	CS/UOS	Location
80320019	8 qt.	064277063083	1402040.Q08P	8/8	National
80320021	16 qt.	064277063168	1402040Q16U	120/4	National
80320023	1.5 cu. ft.	064277063151	1402040.CFL001.5P	50/50	West
80320024	2 cu. ft.	064277063021	1402040.CFL002P	40/40	West

Orchid Mix

Recommended for terrestrial to semi-terrestrial orchids, Black Gold® Orchid Mix is a premium quality special blend of small bark, peat moss and perlite/pumice. It contains added lime, to regulate pH and is highly recommended for Cymbidium, Paphiopedilum, and Phaius orchid species, among others.



Item #	Desc	UPC	Vendor	CS/UOS	Location
80320004	8 qt.	064277124814	1411402.Q08P	8/8	National



Professional Potting Mix

An all-purpose potting mix based on our professional formulation used by commercial growers, Fafard® Professional Potting Mix is a top-quality peat-based blend recommended for all indoor and outdoor container plantings. This product contains Resilience™ for stronger stems and improved root mass.

Item #	Desc	UPC	Vendor	CS/UOS	Location
80320082	1 cu. ft.	066807202900	6700104	70/70	East
80320083	2 cu. ft.	066807202917	6400204	40/40	East

Ultra Container Mix with Extended Feed

A rich, ready-to-use all purpose container mix is recommended for a wide variety of bedding and potted plants grown indoors and out. It is fortified with a slow-release fertilizer that continues to feed plants for up to six months, Contains Resilience™ for stronger stems and improved root mass and MoisturePro water-holding crystals to help maintain moisture.

Item #	Desc	UPC	Vendor	CS/UOS	Location
80320087	1 cu. ft.	066807202924	4705106	70/70	East
80320088	2 cu. ft.	066807202931	4405206	40/40	East

Ultra Potting Mix with Extended Feed

A rich, ready-to-use potting mix recommended for a wide variety of bedding and potted plants grown indoors and out. It is fortified with a slow-release fertilizer that continues to feed plants for up to six months. This product contains Resilience™ for stronger stems and improved root mass.

Item #	Desc	UPC	Vendor	CS/UOS	Location
80320079	1 cu. ft.	066807202955	4705101	70/70	East
80320080	2 cu. ft.	066807202962	4405201	40/40	East

Ultra Outdoor Planting Mix

Rich in organic matter, this high-quality planting mix has been formulated for garden and landscape planting. It contains Canadian sphagnum peat moss and aged pine bark to add structure and needed organic matter to clay-rich or sandy soils.

Item #	Desc	UPC	Vendor	CS/UOS	Location
80320086	1 cu. ft.	066807202948	4705105	70/70	East

Natural & Organic Potting Soil

Approved for organic gardening. Contains a rich blend of organics to produce healthy container plantings for indoor and outdoor growing. This product contains Resilience™ for stronger stems and improved root mass.



Item #	Desc	UPC	Vendor	CS/UOS	Location
80320085	1 cu. ft.	066807202894	4705103	70/70	East

Premium Topsoil

This premium topsoil will add much-needed organic matter to any garden soil or landscape planting requiring enrichment. It is also ideal for starting or top-dressing lawns or filling low spots in the landscape or garden.

Item #	Desc	UPC	Vendor	CS/UOS	Location
80320089	1 cu. ft.	066807201705	4405206	70/70	East

Premium Natural & Organic Compost Blend

Formulated for organic gardening, this is a rich blend with added nutritive benefits. It will enrich any garden bed or landscape planting, from bedding annuals, perennials, and vegetables to trees and shrubs.

Item #	Desc	UPC	Vendor	CS/UOS	Location
80320091	1 cu. ft.	066807201699	4005108	70/70	East

Garden Manure Blend

This rich manure blend is best used in annual and perennial flower beds, vegetable gardens, and for enriching landscape areas around shrubs, trees, and lawns.

Item #	Desc	UPC	Vendor	CS/UOS	Location
80320090	1 cu. ft.	066807312104	4000455	70/70	East

Sunshine® #4

Recommended where high air capacity and fast drainage are needed: during winter months, with water and salt sensitive crops, or where frequent leaching is required.



Item #	Desc	UPC	Vendor	CS/UOS	Location
80320134	3.8 cu. ft.	064277074447	504.CFC003.8P	30/30	East
80320135	3.8 cu. ft. contains RSI	064377074447	1341.CFC003.8P	30/30	West

2025



All Purpose Premium Potting Soil

This is a great soil blend for your Proven Winners plants and all of your gardening needs. Professional-grade potting soil made from a blend of premium Canadian sphagnum peat moss, processed softwood bark and horticultural-grade perlite. This blend also contains a professional wetting agent and dolomite lime to buffer soil pH. Available in two sizes. Soil is the base foundation that produces more beautiful, vibrant flowers and stronger growth - for more color in your garden. Unique medium weight mix, with excellent air porosity, drainage and healthy roots. Easy and ready to use from the bag. Suitable for use on almost all plants and potting arrangements.



Orchid Sphagnum Moss

Orchid and Nursery Sphagnum Moss is a premium grade, long fiber and long-lasting sphagnum. Its long fibers and superior water retention properties make it ideal for lining hanging baskets and using as soil cover in window boxes and house plants. It makes for an excellent soil conditioner or top layer on potted plants like Orchids!



Item #	Desc	UPC	Vendor	CS/UOS	Location
80231118	4oz	759834223061	22306	10/10	National
80230217	Mini Bale 1 lb	759834223252	22325	12/12	National
80230019	3.5 lb	759834223306	22330	6/6	National

2025

Item #	Desc	UPC	Vendor	CS/UOS	Location
81000004	16qt	064277803160	3101012.Q16P	120/12	National
81000005	1.5ct	064277802156	3101013.CFL001.5P	75/5	National

Coco Peat Buff Mini Bale

Professional growers are heralding coconut soil as the #1 choice in gardening for its numerous inherent qualities. Coco Peat soils are a superior eco-friendly alternative to peat moss.



Item #	Desc	UPC	Vendor	CS/UOS	Location
80231268	0.6 cf	759834232773	23277	12/12	National



Butterfly Clips

SuperMoss Orchid and Plant Clips are a garden staple. They're perfect for orchids, vines, and climbing plants not to mention hair!



Item #	Desc	UPC	Vendor	CS/UOS	Location
80230200	10pc	759834905448	90544	12/12	National

Instant Green Mat

Green mountain moss. Easy to cut into any size or shape. Cover almost anything you can imagine.



Item #	Desc	UPC	Vendor	CS/UOS	Location
80230010	18"x48"	759834224303	22430	12/12	National

White Sand Jar

A versatile floral and garden top dressing that can be used in clear vases, centerpieces, terrariums, succulent gardens, fairy gardens, and even potted plants! Our sand comes in a resealable jar which is perfect for people who only need a small touch. The sand is child, pet, and environmentally safe. It is biodegradable yet perfectly suitable for outdoor applications.



Item #	Desc	UPC	Vendor	CS/UOS	Location
80230940	12 oz.	759834243106	24310	12/12	National

Preserved Fresh Green Forest Moss

SuperMoss Forest Moss is ideal for lining baskets, window boxes and wire baskets. Perfect for a grassy moss look around plant bases and above soil. Easy to use and the perfect finishing touch to any floral creation.



Item #	Desc	UPC	Vendor	CS/UOS	Location
80230511	80.75 cu. in.	759834253204	25320	12/12	National
80230014	8 oz	759834253228	25322	10/10	National



Preserved Spanish Moss

Dust free Spanish moss preserved to remain soft and supple for your use as a soil topper, in floral arrangements and craft projects.



Item #	Desc	UPC	Vendor	CS/UOS	Location
80230016	8 oz. Natural	759834269144	26914	10/10	National
80230507	80.75 cu. in.	759834269007	26900	12/12	National

Orchid Sphagnum Moss Dried Natural

Orchid and Nursery Sphagnum Moss is a premium grade, long fiber and long-lasting sphagnum. Its long fibers and superior water retention properties make it ideal for lining hanging baskets and using as soil cover in window boxes and house plants. Sphagnum helps you take the guesswork out of watering your garden plants by absorbing up to 18 times its weight in water.



Item #	Desc	UPC	Vendor	CS/UOS	Location
80230216	200 cu. in.	759834223016	22301	10/10	National
80230722	0.35lb Bale	759834223245	22324	12/12	National

Moss Mix Best Sellers

SuperMoss Moss Mix comes in our elegant window box retail display. It is a collection of our best selling mosses so you can mix and match, experiment with new styles and get a feel for the different types of our premium quality mosses. Includes: Spanish Moss in Grass Green, Reindeer Moss in Chartreuse, Sheet Moss and Lichen Parmelia with tufts of Fuchsia Reindeer Moss in the center! All included mosses and lichens are in their natural form. SuperMoss Moss Mix is a great product for decorative purposes and for terrariums or crafts.



Item #	Desc	UPC	Vendor	CS/UOS	Location
80230726	80 cu. in.	759834233107	23310	12/12	National



Preserved Reindeer Moss

Softened and color enhanced for lasting beauty. Ideal for covering soil and dressing container plants. Clean and easy to use and allows soil to retain moisture longer.



Item #	Desc	UPC	Vendor	CS/UOS	Location
80230437	Chartreuse 2oz	075983421708	21708	12/12	National
80230007	Chartreuse 8oz.	759834216698	21669	10/10	National
80230009	Forest 8oz.	759834217572	21757	10/10	National

Sheet Moss Preserved - Fresh Green

Flat, thin sheets of natural moss. Preserved and color enhanced for lasting beauty. Ideal for covering soil and dressing container plants. Clean and easy to use and allows soil to retain moisture longer. Excellent for dressing orchids.



Item #	Desc	UPC	Vendor	CS/UOS	Location
80230509	2 oz.	759834215097	21509	12/12	National
80230001	8 oz.	759834215127	21512	10/10	National
80230520	5 lb. Bulk 1560 cu. in. Box	759834215080	21508	1/1	National

Spanish Moss

It grows in a swirly, spaghetti-like fashion and makes for an excellent touch to floral displays, creative projects, and your garden. Our product is responsibly procured and comes in its natural color as well as a variety of enhanced colors to match your home decor. Our product is durable and reliable to provide long-lasting beauty. It is ideal for covering soil or dressing container plants, bulbs & orchids. Spanish Moss is also a great natural fill for gift baskets. Cleaned before packaging to remove small particles.



Item #	Desc	UPC	Vendor	CS/UOS	Location
80230015	8oz	759834269120	26912	10/10	National



Forest Moss Dried Natural

This moss works great above and below the soil! Dried Forest Moss is perfect for a more grassy moss look around plant bases and above the soil.



Item #	Desc	UPC	Vendor	CS/UOS	Location
80230145	8 oz 200 cu. in.	759834215776	21577	10/10	National

Lichen Parmelia Natural Grey

Branched Lichen Parmelia makes a great off-season fireplace decor used as an accent alongside firewood. Lichen has natural and unique variations in size and texture to create natural beauty only found in nature.



Item #	Desc	UPC	Vendor	CS/UOS	Location
80231135	180cu in	759834235309	23530	12/12	National

Moss Mix Best Sellers

Moss Mix is a collection of our best-selling mosses so you can mix and match, experiment with new styles and get a feel for the different types of our mosses. Our Moss Mix is a variety of the following mosses and lichens: Spanish Moss in Grass Green, Reindeer Moss in Chartreuse, Sheet Moss and Lichen Parmelia with tufts of Fuchsia Reindeer Moss in the center! SuperMoss Moss Mix is a great product for decorative purposes and for terrariums or crafts.



Item #	Desc	UPC	Vendor	CS/UOS	Location
80230727	200 cu. in.	759834233121	23312	10/10	National

Orchid Bark

Excellent propagation and potting media for orchids. Ideal soil cover for indoor and outdoor container plants. Great for air plants, epiphyte orchid species that grow on branches above the rainforest floor. Provides a natural growing environment and moisture retention that will not suffocate delicate root systems.



Item #	Desc	UPC	Vendor	CS/UOS	Location
80230011	8 oz.	759834231141	23114	8/8	National

Orchid Potting Bark

A custom blend of natural Douglas-fir tree bark, organic moss & river sand. We designed this blend specifically to the needs of wholesale orchid growers in California. Its pH makes it an ideal potting medium for orchids. It allows for great oxygenation and drainage of water so that the orchid's roots have constant access to both water and oxygen. This mimics an orchid's natural environment and helps them grow to their full potential.



Item #	Desc	UPC	Vendor	CS/UOS	Location
80230198	4 qt.	759834231158	23115	8/8	National

Spanish Moss

Preserved Spanish Moss is a company staple. It grows in a swirly, spaghetti-like fashion and makes for an excellent touch to floral displays, creative projects, and your garden.



Item #	Desc	UPC	Vendor	CS/UOS	Location
80230504	80.75 cu. in. Grass	759834269021	26902	12/12	National
80230306	200 cu. in. Coffee	759834269724	26972	10/10	National



Reindeer Moss

Reindeer Moss is one of our top selling mosses for floral decor. It adds natural accents to any floral arrangement. Choose from a variety of lush colors and pair your moss perfectly with your flowers' natural colors to give them true definition.

Item #	Desc	UPC	Vendor	CS/UOS	Location
80230435	80 cu. in. Natural	075983421702	21702	12/12	National
80230008	8oz Natural	759834217220	21722	10/10	National
80230436	80 cu. in. Forest	075983421703	21703	12/12	National
80231010	2oz. Fuchsia	759834231646	23164	12/12	National

LAWN CARE & SEED



CHECK OUT OUR
CLEARANCE ITEMS!

DROP SHIP VENDORS

Jonathan Green

Minimum orders:

CT,DE,IL,IN,KY,Long Island, MA, MI,NJ,NY,OH, PA, VT - PPD \$1,250

MD,ME,MN,NH,WI - PPD \$1,450

NC,TN,VA,WV - PPD \$1,500

KY - PPD \$1,700

Orders under minimum \$ will receive a \$150 delivery charge

\$35 fuel charge per order

Limestone does not count towards delivery minimums



Griffin Greenhouse Retail WAREHOUSE Shipping Map

We are now shipping nationwide!

NATIONAL



2025

Refer to location key:

National items are stocked nationally
 Select items are sold East or West only; no exceptions

8" Kaleidoscope Planter

Premium plastic modular planter can be displayed individually each planter has a removable saucer ideal for succulents or shallow rooted planted.

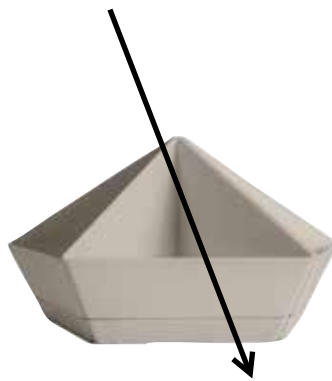

Item #	Desc	UPC	Vendor	CS/UOS	Location
80282643	Vanilla Bisque	770932844170	KDP08000A58	6/6	National

Where is the pricing?

1. Scan QR code on Chapter Pages to see pricing on Griffins.com
2. Contact your Griffin Sales Representative
3. Call into Griffin Customer Service 800.888.0054





Wildflower Blanket

Easy to plant Wildflower Seeded Blanket in a roll. Just unroll, cut to size and water; It's that simple! A mixture of perennial and annual flower seeds, natural fertilizer and mulch.



Item #	Desc	UPC	Vendor	CS/UOS	Location
82380017	10sqft	12783253252	25325	8/8	East

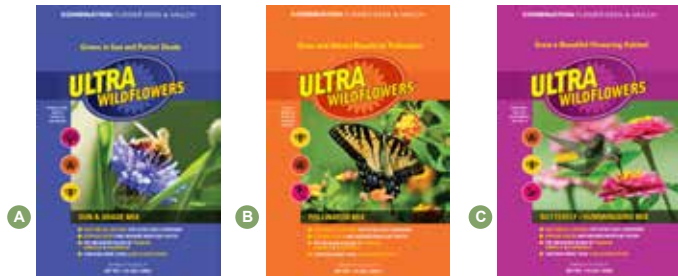

Ultra wildflower mixes are a combination of seed, fertilizer and mulch all in one package. It has a pre-measured blend of perennials and annuals, it spreads easily and absorbs moisture quickly. Comes in a resealable bag and will cover 50 square feet area.

Ultra Wildflower Sun & Shade (A)

Item #	Desc	UPC	Vendor	CS/UOS	Location
82380018	12pk 1.75lb	12783443257	44325	12/12	East

Ultra Wildflower Pollinator (B)

Item #	Desc	UPC	Vendor	CS/UOS	Location
82380020	12pk 1.75lb	1278344388	44386	12/12	East

Ultra Wildflower Butterfly & Hummingbird (C)

Item #	Desc	UPC	Vendor	CS/UOS	Location
82380022	12pk 1.75lb	12783443530	44353	12/12	East

Straw Blanket

Ultra StrawBlanket Lawn Germination Blanket is the all-natural and easy way to protect seedlings while facilitating growth. Processed straw and seeding mulch protects seedlings while facilitating new growth. Does not contain grass seed.



Item #	Desc	UPC	Vendor	CS/UOS	Location
82380025	100sqft	012783250350	25035	9/9	East
82380026	200sqft	012783250367	25036	9/9	East



The Original Lawn Patch

Helps to repair bare spots. 100 Sq Ft Of Coverage. Spreads easier and absorbs moisture faster than any other combination product.

Item #	Desc	UPC	Vendor	CS/UOS	Location
82380010	5lb Sun & Shade	012783000177	34332	10/10	East
82380009	5lb Shady	012783000078	34322	10/10	East
82380008	5lb Sunny	012783000061	34321	10/10	East

Ultra Lawn Patch

Uses all natural ingredients from plant extract plus seaweed and kelp: a premium blend of lawn seed, and granular recycled paper mulch to create an all - in - one lawn patch repair package.



Item #	Desc	UPC	Vendor	CS/UOS	Location
82380003	5lb 300sq ft	012783453324	45332	10/10	East
82380004	20lb	012783423327	42332M	1/1	East

Ultra Nu-Straw Bale

Amturf Ultra Nu-Straw is a twice-cut, processed straw mulch that provides erosion protection on slopes, heavy washout, and windy areas. Ideal straw for seeding, it includes a bonding agent that gives straw a tackiness which holds it together and protects seed from erosion and birds. Speeds up germination and holds water to reduce water evaporation. Safe for pets and children. Does not contain grass seed.



Item #	Desc	UPC	Vendor	CS/UOS	Location
82380027	2.5cuft	12783250404	25040	40/1	East

Green Guard Lawn Repair Bale

Natural and sustainable combination of premium grass seed, natural fertilizer and recycled straw. Contains Double Time for quicker establishment and weed suppression while using less water, less fertilizer and less chemicals. Contains nutrient-rich fertilizer that is sourced from recycled wastewater bio solids to absorb moisture and establish a robust root system. Contains 100% natural, recycled and weed-free straw mulch with tackifier to prevent erosion.



Item #	Desc	UPC	Vendor	CS/UOS	Location
82380005	11 lb.	12783882117	88211	1/1	East



Moss Max® Lawn Granules

Kills lawn moss quickly, see results in hours. Contains no fertilizer for no excess growth and less mowing. Applies easily with standard lawn spreaders.

Not for sale in AK, CA, DC, HI, PR



Item #	Desc	UPC	Vendor	CS/UOS	Location
80100030	6 lb. Shaker	037321607250	60725	9/9	National

Weed Beater Complete®

This unique product provides both pre-emergent and post emergent control of both grassy and broadleaf weeds - including crabgrass, nutsedge, goosegrass, ground ivy and others. Systemic action from the leaves down and the roots up inhibits cell division and disrupts photosynthesis. Works equally well on cool and warm season grasses. Weed Beater Complete is a synergistic combination of prodamine and sulfentrazone. Exhibits excellent cool weather performance. 10 lb. treats up to 5200 sq. ft. **Not for sale in AK, CA, DC, HI, NY, PR, DE, LA**



Item #	Desc	UPC	Vendor	CS/UOS	Location
80100122	10 lb.	037321604761	60476	4/4	National

Infuse® Lawn & Landscape Granules

2.08% Thiophanate-Methyl. Prevents and controls over 30 plant diseases, including tough to control soil borne pathogens of bulbs, annual and perennial flowers, bedding plants and ground covers, deciduous and evergreen trees and shrubs. Treats up to 5,000 sq. ft. of turf.

Not for sale in AK, HI



Item #	Desc	UPC	Vendor	CS/UOS	Location
80100123	7½ lb.	037321605140	60514	4/4	National

Annual™ Grub Beater

One annual application is all it takes to control grubs all season long... "It's that simple!" Also kills European Crane Fly larvae, mole crickets and other turf destroying insects. Apply any time, spring through summer.

Not for sale in CA, CT, ME, MD, MA, NJ, NY, PR, RI, SD, VT, CO



Item #	Desc	UPC	Vendor	CS/UOS	Location
80100105	5M	037321006039	603	4/4	National

Infuse®

1.55% Propiconazole (Banner®). Powerful systemic protection that prevents and cures. Won't wash off. Lasts up to one month. Provides broad spectrum of disease control on roses, flowers, lawns, trees and shrubs. Proven to encourage turf rooting and improve color in woody shrubs.

Not for sale in AK, HI, PR



Item #	Desc	UPC	Vendor	CS/UOS	Location
80100054	32 oz. RTS	037321001508	150	12/12	National

Moss Max®

Fast-acting, water-based, multi-purpose formula works within hours to kill moss, algae and lichens. Safe for use on lawns, trees, roofs, decks, patios, walkways and other structures. Will not stain or damage desirable plants. Also removes green slime. Contains 22.11% potassium soap.

Not for sale in DC, HI



Item #	Desc	UPC	Vendor	CS/UOS	Location
80100002	32 oz. RTS	037321007289	728	12/12	National



Season Long Grub Control

Patented 2 in 1 formula kills grubs all season long plus promotes strong roots and thicker turf. Creates a season long protective zone to kill grubs before they do damage. Apply anytime spring through late summer. Also kills mole crickets and European crane fly larvae. Suppresses chinch bugs and cutworms. NON-NEONIC version active ingredient: Lambda-cyhalothrin. Neonic version - active ingredient: Imidacloprid plus 6-0-1 fertilizer.



Item #	Desc	UPC	Vendor	CS/UOS	Location
82270074	5M 10lb (non-neonic)	687073007053	700705H	42/1	National
82270075	5M 12lb. Not For Sale in CA, CO, CT, MA, MD, ME, NJ, NV, NY, RI, VT	687073007107	700710M +Turf Revitalizer	42/1	National
82270003	10M 24lb Not For Sale CA, CO, CT, FL, ME, MD, MA, NV, NJ, NY, RI, VT	687073007206	700720S +Turf Revitalizer	36/1	National



Complete Brand Insect Killer Soil & Turf (Non-Neonic)

The Complete Insect Killer for Soil and Turf I controls over 500 surface insects! The fast-acting formula kills pests on contact including grubs, ants, ticks, and more. It even kills mosquitoes.

The Complete Insect Killer provides protection from listed insects. It can be used on soil and turf lawns around the home. AI: Cyfluthrin



Item #	Desc	UPC	Vendor	CS/UOS	Location
82270115	RTS 32 oz (non-neonic) Restricted CA Not for sales PR	840216200890	700384A	8/8	National
82270114	Conc 40 oz (non-neonic) Restricted CA Not for Sale PR	687073003772	700377A	8/8	National

Complete Brand Insect Killer for Lawns (Non-Neonic)

The Complete Brand Insect Killer for Lawns kills all types of listed lawn damaging insects on contact. Apply once on lawns and as a barrier treatment for season-long control against insects above and below the surface, such as ants, ticks, mole crickets, grubs, chinch bugs and crickets. And it kills fire ants and prevents new mound formations for up to 3 months. AI: Lambda-Cyhalothrin



Item #	Desc	UPC	Vendor	CS/UOS	Location
82270056	12.5M 10lb (non-neonic)	687073002942	700294L	56/1	National
82270057	25M 20lb (non-neonic)	687073002959	700295H	32/1	National

Complete Brand Insect Killer Soil & Turf (Neonic)

Complete Insect Killer for Soil and Turf's fast-acting formula kills listed insects both above and below ground including grubs, ants, ticks, and more. It even kills mosquitoes. The Complete Insect Killer kills surface insects in 24 hours and provides up to 3 months of protection against listed soil insects. It can be used on soil and turf lawns around the home. AI: Imidacloprid, beta-cyfluthrin

Item #	Desc	UPC	Vendor	CS/UOS	Location
82270111	RTS 32oz (neonic) Not For Sale CA, CO, CT, MA, MD, ME, NJ, NV, NY, RI, VT	687073002805	700280B	8/8	National
82270110	Conc 40 oz (neonic) Not For Sale CA, CO, CT, MA, MD, ME, NJ, NV, NY, RI, VT	687073002706	700270B	8/8	National
82270112	10M 10lb. (neonic) Not For Sale CA, CO, CT, MA, MD, ME, NJ, NV, NY, RI, VT	687073002881	700288H	42/1	National
82270113	20M 20lb (neonic) Not For Sale CA, CO, CT, MA, MD, ME, NJ, NV, NY, RI, VT	687073002898	700289G	24/1	National



24 Hour Grub Control

Excellent turf rescue formula delivers overnight results. High-efficiency granules provide 50% higher concentration, 33% less weight, and same great coverage. Kills grubs in 24 hours. Plus kills ants, billbugs, chinch bugs, crickets, cutworms, earwigs, grasshoppers, leafhoppers, millipedes, mole crickets, pillbugs, scorpions, sod webworms, sowbugs, and ticks. Active Ingredient: Dylox. Restricted CA, ME



Item #	Desc	UPC	Vendor	CS/UOS	Location
82270076	5M 10 lb.	687073007404	700740M	42/1	East
82270077	10M 20 lb.	687073007459	700745S	36/1	National

Fungus Control

Fungus Control for Lawns effectively eliminates fungal infections like brown patch, red thread, and dollar spot from your lawn. This product offers excellent disease protection with just one application. Its active ingredients provide long-lasting, residual control for up to one month.



Item #	Desc	UPC	Vendor	CS/UOS	Location
82270083	RTS 32 oz	840216200760	701270A	8/8	National
82270082	5M 10lb	687073012309	701230F	42/1	National

2 in 1 Moss & Algae Killer

Kills moss, algae, and lichen wherever it grows. Acts like two products in one - treats lawns and patios plus roofs and buildings. The odorless, non-staining formula kills within hours and protects for months. Will not harm turf when used as directed. Active ingredient: 22.1% fatty acid. Treats up to 5,000sq ft.



Item #	Desc	UPC	Vendor	CS/UOS	Location
82270044	RTS 32 oz (non-neonic)	840216200777	704710B	8/8	National

Bermudagrass

For use on cool season grasses such as Fescue, Kentucky Bluegrass and Perennial Ryegrass. Rainproof in 1 hour, treats 5,000 sqft **Not for sale in AK, HI, FL, LA, MA, ME, MN, NH, NJ, NY, ND, PR, RI, SD, VT, & WI**



Item #	Desc	UPC	Vendor	CS/UOS	Location
82270085	RTS 32oz	687073041002	704100B	8/8	National

BIOADVANCED
 SCIENCE-BASED SOLUTIONS

All In One Lawn Weed & Crabgrass Killer

BioAdvanced All-In-One Lawn Weed & Crabgrass Killer Kills Listed Lawn Weeds PLUS Crabgrass and Other Grassy Weeds without Harming Your Lawn.



Item #	Desc	UPC	Vendor	CS/UOS	Location
82270086	RTU 24oz (non-neonic) Not for Sale HI, PR	687073041255	704125A	12/12	National
82270084	RTS 32 oz (non-neonic) Not For Sale HI, NY, LINY	687073040807	704080A	12/12	National
82270064	Conc 40oz Not For Sale HI, TX, NY	687073041408	704140B	8/8	National
82270087	RTU 1 Gal (non-neonic) Not for Sale PR	687073041309	704130A	4/4	National
82270088	1.3 Gal (non-neonic) Not For Sale HI, PR	687073041385	704138A	4/4	National

Extreme Crabgrass Killer

Extreme Crabgrass Killer is a specialized crabgrass solution that kills down to the root. The exclusive formula kills even large, hairy and smooth crabgrass. In addition to fighting off crabgrass, it kills grassy weeds including foxtail, sandbur, bermudagrass, and more. For best results, apply at the first sign of weeds and when temperatures are below 90 degrees. It can be used on Northern turfs such as Fescue, Perennial Ryegrass, and Kentucky Bluegrass. It is NOT intended for use on St. Augustine, Floratum, Bermudagrass, Bentgrass, Zoysiagrass, Centipede or Bahia lawns.



Item #	Desc	UPC	Vendor	CS/UOS	Location
82270001	RTS 32 oz (non-neonic)	687073041194	704119A	8/8	National

Weed & Feed

5 In 1 Weed & Feed kills broadleaf weeds, prevents broadleaf weeds. Kills Crabgrass and prevents new Crabgrass. Plus, it feeds and greens up to 3 months. Our revolutionary formula also prevents new weeds – up to 6 months! And if Crabgrass is your problem, we have you covered. 5 In 1 Weed & Feed kills Crabgrass and prevents new Crabgrass – up to 6 months. 5 In 1 takes the guesswork out of lawn care. Apply it in spring or early summer, even if Crabgrass and weeds have already sprouted. It doesn't matter. Since it's both a preventer and killer, one application gets results. **Not for sale in HI, NY or FL. State registrations pending in CA and PR.**



Item #	Desc	UPC	Vendor	CS/UOS	Location
82270212	9.6 lb.	840216201712	704860E	4/4	East

Weed & Grass Killer

The fast and powerful root kill action of BioAdvanced Weed & Grass Killer 32 ounce Super Concentrate begins working after 3 hours. Our multi-purpose formula provides maximum control to kill even the toughest brush. Only one application is needed to kill annual and perennial weeds dead so they don't come back. Not all weed killers are the same. Whether treating spots or landscapes, along fences or in walkways.



Item #	Desc	UPC	Vendor	CS/UOS	Location
82270102	RTU 24 oz (non-neonic) Restricted NY	687073041972	704197A	8/8	National
82270103	RTU 1 Gal (non-neonic) Restricted NY	687073041989	704198A	4/4	National
82270104	RTU 1.3 Gal Power Sprayer Restricted NY	687073041996	704199A	4/4	National

Lawn Weed Granules North

Kills over 200 types of listed weeds, including hard to kill weeds like Clovers, Dandelions and Crabgrass. Prevents weeds and crabgrass up to 6 months. Contains 24-D, Quinclorac, Dicamba, Dithiopyr. **Restricted FL, HI, NY**



Item #	Desc	UPC	Vendor	CS/UOS	Location
82270015	4M case 9.6 lb.	840216200593	820059B	4/4	National

365 Weed & Grass Killer

365 Weed & Grass Killer Concentrate kills and prevents all types of weeds and grasses. The non-selective herbicide kills the root and controls weeds for up to one year. Use 365 Weed & Grass Killer around trees and shrubs, patios, along fences and foundations, flower beds, driveways and walkways.



Item #	Desc	UPC	Vendor	CS/UOS	Location
82270025	Conc 28 oz (non-neonic) Not For Sale CA Restricted NY	840216200555	820055B	8/8	National

Lawn Weed Killer -Southern & Northern Lawns

Lawn Weed Killer kills more than 200 listed broadleaf weeds to the root. It is safe to use on Northern and Southern Lawns, including St Augustine turf. It kills Clover, Dollarweed, Dandelion, Spurge, Oxalis and more. When used as directed, it won't harm lawns and it is rainproof in only one hour.



Item #	Desc	UPC	Vendor	CS/UOS	Location
82270093	RTS 32oz (non-neonic)	840216200951	705110A	8/8	National



Residential Push Turf Spreader

Lawn Spreader starter model has a 65 lb. capacity hopper, powder coated steel frame, adjustable gate with 30 gate settings for seed and fertilizer, and enclosed gears to withstand the elements.



Item #	Desc	UPC	Vendor	CS/UOS	Location
82210088	65lb.	023883080006	8000A	3/3	National

Spreader Hand Crank

Compatible with fertilizer, seeds and sale/ ice-melt. Easy-crank design with enclosed gears to protect from debris. Lightweight and easy to maintain.



Item #	Desc	UPC	Vendor	CS/UOS	Location
82210107	1.6L	023883087067	8706A	3/3	National



Grass-Fast Natural Roll

Traps heat and moisture to speed and increase seed germination. Also protects newly planted seed from erosion. Easier to use and more effective than straw, ideal for slopes and difficult areas. Also good for frost protection. Reusable. 200 sq. ft. coverage.



Item #	Desc	UPC	Vendor	CS/UOS	Location
82170084	4' X 50'	016069004903	EXC-200	1/1	National

Straw Blanket Roll

Biodegradable straw erosion control blanket. Straw fiber with net. Ideal for covering grass seed during germination. Also protects newly planted seed from erosion. 200 sq. ft. coverage. Product is Manufactured in the United States.



Item #	Desc	UPC	Vendor	CS/UOS	Location
82170086	4' X 50'	016069004910	STR-200	1/1	National



Fall Winterizer 8-0-5

Supplies long-lasting nitrogen, an essential nutrient that helps to promote a thicker lawn and vigorous growth. It is also fortified with potassium, a nutrient that helps the lawn recover from summer drought conditions, enhances winter hardiness and helps promote a better spring greening the following season.



Item #	Desc	UPC	Vendor	CS/UOS	Location
80030087	30 lb.	050197058308	EOFW30	1/1	East

Spring Lawn Booster 8-0-0

An affordable, chemical-free lawn program that is safe for kids and pets. All Espoma Organic Lawn Products are specifically formulated to optimize the help of the lawn, and provide 2.5 times more slow-release nitrogen (SRN) than conventional lawn programs. Fortified with extra calcium to speed up spring greening.



Not For Sale in CA

Item #	Desc	UPC	Vendor	CS/UOS	Location
80030084	30 lb.	050197055307	EOLB30	1/1	East

Summer Revitalizer 8-0-0

Contains Bio-tone microbes that help make nutrients more available to your lawn. These microbes will help promote faster greening, deeper roots and improved soil structure. Fortified with 2% non staining iron.



Not For Sale in MS

Item #	Desc	UPC	Vendor	CS/UOS	Location
80030086	30 lb.	050197057301	EOSR30	1/1	East

Weed Preventer 9-0-0

Helps prevent unsightly weeds from popping up in your lawn while it nourishes the grass so that it becomes more resistant to heat, drought and other stress. This product is all-natural, it is safe for your family, your pets and the environment. Made from corn gluten meal.



Not For Sale in CA, NM, OR

Item #	Desc	UPC	Vendor	CS/UOS	Location
80030083	25 lb.	050197052252	CGP25	1/1	East



All Season Lawn Food 9-0-0

Finally, an affordable, chemical – free lawn program that is safe for kids and pets. All Espoma Organic Lawn Products are specifically formulated to optimize the help of the lawn, and provide 2.5 times more slow release nitrogen (SRN) than a conventional lawn program. All Season Lawn Food also contains Bio-tone Microbes that help make nutrients more available to your lawn. These microbes will help promote faster greening, deeper roots, and improved soil structure.



Item #	Desc	UPC	Vendor	CS/UOS	Location
80030125	28 lb.	050197056281	EOLF28	1/1	East

2025

Lightning Lime™

Treated with a natural humic acid that helps the soil and plants convert calcium into an immediately available form. Lightning Lime can work in just 6 to 8 weeks instead of the up to 14 months other lime products require. Lightning Lime is also less dusty than traditional lime products and is approved for organic gardening. One bags equivalent to five bags of conventional Lime. **Not For Sale CA, HI, IL, OR, WI**



Item #	Desc	UPC	Vendor	CS/UOS	Location
80030137	30 lb.	050197060301	LL30	30/1	East

Lawn Food 15-0-5

Espoma Lawn Food is a premium formula designed for safe, easy lawn feeding for the home gardener as well as the professional horticulturist. It provides slow release nitrogen for extended feeding and is granular, non-burning, and easy to apply. Plus Espoma Lawn Food now contains non-staining iron, and is now enhanced with Biotone® microbes. **Not For Sale CA, HI, IL, OR**

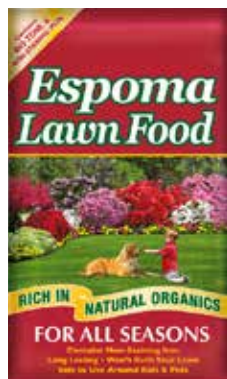

Item #	Desc	UPC	Vendor	CS/UOS	Location
80030082	20 lb.	050197053204	ELF20	1/1	East
80030081	40 lb.	050197053402	ELF40	1/1	East

ferti-lome®

New Lawn Starter 9-13-7

When you're planting a new lawn, don't leave your grass growing success to chance - trust ferti-lome New Lawn Starter Fertilizer to help! This balanced fertilizer is specially formulated to encourage grass seed to develop healthy roots and stems before beginning rapid growth. It's also formulated to fertilize sod, and can be used when sprouting new grass, as well.

Not For Sale HI, PR, VI, WI



Item #	Desc	UPC	Vendor	CS/UOS	Location
82280081	4 lb.	732221109049	10904	12/12	National
82280079	10 lb.	732221109025	10902	1/1	East
82280082	20 lb.	732221109063	10906	1/1	National
82280080	40 lb.	732221109032	10903	1/1	East

Centipede Lawn Fertilizer 15-0-15

Prevents and correct yellow grass foliage and gives your lawn the fast super green you desire. Provides essential nutrients with slow release nitrogen to reduce the risk of nitrogen burn. The 20 lb. bag covers up to 5,000 square feet of lawn. See label to recommended grass types.

Not For Sale AK, AZ, CA, CO, DE, HI, ID, IL, IN, KS, KY, MA, MD, ME, MI, MN, MT, NE, NH, NM, NV, OH, OR, PR, RI, SD, UT, VI, VT, WA, WI, WY



Item #	Desc	UPC	Vendor	CS/UOS	Location
82280060	20lb.	732221107670	10767	1/1	East

MosquitoGo

Safe for use around kids, pets, insects such as bees, butterflies, and ladybugs.

Controls mosquitoes, ants, fleas, beetles, crickets, roaches, chinch bugs, flies, gnats, and numerous other insect pests. Safe to use around children and pets when used as directed. Features a pleasant scent. Active Ingredient: Cedar Oil. **Not For Sale AK, DC, HI, ID, IN, KY, MD, NM, NY, PR, RI, VI, WI**



Item #	Desc	UPC	Vendor	CS/UOS	Location
82280005	10 lb.	732221100510	10051	1/1	East

MosquitoGo Yard Fogger

When you have a big problem with insects like mosquitoes and biting flies, you need a powerful tool like ferti-lome MosquitoGo Yard Fogger. MosquitoGo Fogger contains a combination of ingredients that help provide rapid elimination of many nuisance insects. It works best on yards, porches, patios, screens, window frames, and doors. Permethrin 0.2% and Tetramethrin 0.2% **Not For Sale AK, CA, CO, DC, DE, GA, HI, IA, KY, MA, MD, ME, MN, MO, MT, ND, NE, NH, NV, NY, OK, OR, PR, UT, VA, VI, VT, WA, WI, WV**



Item #	Desc	UPC	Vendor	CS/UOS	Location
82280003	16 OZ	732221100428	10042	12/12	East

F-Stop Fungicide

Apply ferti-lome F-Stop Fungicide Granules during the growing season for diseases such as brown patch, powdery mildew, pink snowy mold, dollar spot, summer patch, and many others. F-Stop contains Eagle fungicide, which both prevents and controls fifteen different diseases in both established lawns and ornamental turfs. One application protects for up to 4 weeks. **Not For Sale CA, AK, DC, HI, KY, MD, ND, PR, VI, WI**



Item #	Desc	UPC	Vendor	CS/UOS	Location
82280148	10 lb.	732221127708	12770	1/1	East

F-Stop Lawn & Garden Fungicide

Controls damaging diseases like Black Spot, Rust, Blights and more. See label for full list. Designed for outdoor use on roses, flowers, ornamental shrubs, fruits, nuts, vegetables and lawns. Most effective as a fungicide when it is used to prevent diseases before they appear. **Not For Sale CA, DC, HI, IA, KY, MT, PR, RI, VI, VT, WA, WI, AK**



Item #	Desc	UPC	Vendor	CS/UOS	Location
82280059	RTS 32 oz	732221107656	10765	12/12	East

MoleGo Mole Repellent & Lawn Protection Composition

Repels Moles and other small animals from your lawn, garden and flower bed. Can be used in other areas such as ornamental turf, golf courses and athletic fields. **Not For Sale AK, AZ, CO, DC, HI, IN, MD, ME, MT, NV, NY, PR, RI, VI, WI**



Item #	Desc	UPC	Vendor	CS/UOS	Location
82280008	RTS 32OZ	732221103184	10318	12/12	East

Broadleaf Weed

A pre-emergence herbicide for control of certain broadleaf weeds such as: chickweed, clover, dandelion, henbit, spurge, yellow woodsorrel (oxalis). Suppression of annual grasses such as: annual bluegrass (poa annua) and crabgrass established in cool season and warm season turfgrass and landscape ornamentals. **Not For Sale AK, HI, IL, MO, NY, OR, PR, VI, WI**



Item #	Desc	UPC	Vendor	CS/UOS	Location
82280073	10 lb.	732221108851	10885	1/1	East

All Seasons II 16-0-8

For All Seasons II Lawn Food Plus Crabgrass and Weed Preventer is a powerful tool in your yearly lawn care arsenal. An application feeds warm and cool season grasses for up to 5 months, creating a stronger root system for your lawn. All Seasons II also provides weed control for a large variety of grassy and broadleaf weeds. Apply once and your grass will thank you all season long. **Not For Sale AK, AZ, CA, DC, HI, MT, NJ, NY, PA, PR, RI, VT, WI**



Item #	Desc	UPC	Vendor	CS/UOS	Location
82280138	20 lb.	732221119147	11914	1/1	East
82280139	40 lb.	732221119246	11924	1/1	East

Weed-Out Lawn

When weeds sneak up in your lawn, you need ferti-lome Weed-Out Plus Lawn Fertilizer. This weed killer is post-emergent, which means it's made to apply after weeds and crabgrass have sprouted. While controlling weed growth, Weed-Out Plus Lawn Fertilizer also provides a dose of nitrogen fertilizer to strengthen your lawn. Contains Trimec herbicide.



Item #	Desc	UPC	Vendor	CS/UOS	Location
82280015	16oz Concentrate Not For Sale AK, CA, HI, PR, VI, WI, WY	732221105102	10510	12/12	East
82280016	32oz RTS Not For Sale AK, DC, HI, PR, VI, WI	732221105133	10513	12/12	East
82280085	20 lb. Not For Sale AK, CA, DC, HI, MD, NJ, PR, RI, VI, WI, WY	732221109216	10921	1/1	East
82280086	40 lb. Not For Sale AK, CA, DC, HI, MD, NJ, PR, RI, VI, WI, WY	732221109230	10923	1/1	East

Weed-Out Broadleaf Weed Control

Controls over 200 broadleaf weeds including Dandelion, Chickweed and Knotweed. See label for more. For use on Bahia, Bermuda, Zoysia, Kentucky Bluegrass, Fescue and more. See label for full list. This 10 lb. bag of granular weed killer can treat up to 5,000 square feet of lawn and turfgrass. **Not For Sale AK, CA, HI, MT, NY, PR, VI, WI, WY,**



Item #	Desc	UPC	Vendor	CS/UOS	Location
82280087	10 lb.	732221109254	10925	1/1	East

ferti-lome

Over-The-Top II Grass Killer

Controls Annual and Perennial Grass Weeds. Systemic selective broad spectrum post-emergent herbicide that can be sprayed over desired plants listed to control annual and perennial grasses.

Not For Sale AK, HI, PR, VI, WI



Item #	Desc	UPC	Vendor	CS/UOS	Location
82280012	Conc 8oz	732221104341	10434	12/12	East

Grass & Weed Killer

This is a nonselective herbicide. The product kills all grass and weeds it makes contact with. Great for use on Mulch and around Planters, Raise Beds, Driveways, Patios, Foundations and Fences. It can be used in planting beds prior to planting grass or flowers. Formulation: Ammoniated Soap of Fatty Acids 22%. **Not for sale AK, HI, ME, PR, VI, WI**



Item #	Desc	UPC	Vendor	CS/UOS	Location
82280170	RTU 32 OZ	732221161061	16106	12/12	East
82280169	32oz Concentrate	732221161030	16103	12/12	East
82280171	RTU 1 GL	732221161078	16107	4/4	East

Decimate Weed & Grass Killer

This non-selective herbicide kills weeds, grass and some woody plant species. Results can be seen in 24 to 72 hours. Works best in temperatures over 85 degrees. The product is rainfast after 30 minutes to 4 hours depending on sun and temperature. Glufosinate ammonium 24.5%. **Not For Sale AK, CA, HI, PR, VI, WI**



Item #	Desc	UPC	Vendor	CS/UOS	Location
82280112	16oz Concentrate	732221112612	11261	12/12	East
82280113	32oz Concentrate	732221112629	11262	12/12	East

Weed-Out Nutsedge Control

This is a nonselective herbicide. The product kills all grass and weeds it makes contact with. Great for use on mulch and around planters, raise beds, driveways, patios, foundations and fences. sulfentrazone 1.36%, proflaminate 2.73%. **Not For Sale AK, CA, HI, NY, PR, VI, WI**



Item #	Desc	UPC	Vendor	CS/UOS	Location
82280109	16oz Conc	732221112544	11254	12/12	East
82280110	RTS 32 OZ.	732221112575	11257	12/12	East
82280111	RTU 32 OZ.	732221112582	11258	12/12	East

Weed Free Zone

Controls over 80 broadleaf weeds including Clover, Spurge, Chickweed, Thistle, see label for more. Safe on Kentucky Bluegrass, Bermudagrass, Bahiagrass, Zoysiagrass and more. See label for full list. The rapid and effective weed killer provides evidence of injury within hours of application.



Item #	Desc	UPC	Vendor	CS/UOS	Location
82280022	RTS 32oz Not For Sale AK, DC, HI, NY, PR, VI, WI	732221105270	10527	12/12	East
82280023	RTU 32oz Not For Sale AK, CA, HI, OK, PR, VI, WI	732221105287	10528	12/12	East
82280025	RTU 1 gal Not For Sale AK, CA, HI, OK, PR, VI, WI	732221105324	10532	4/4	East
82280019	8 oz concentrate Not For Sale AK, HI, PR, VI, WI	732221105232	10523	12/12	East
82280020	16 oz concentrate Not For Sale AK, HI, PR, VI, WI	732221105249	10524	12/12	East
82280021	32 oz concentrate Not For Sale AK, HI, PR, VI, WI	732221105256	10525	12/12	East

Weed-Out w/ Crabgrass Killer

Selective weed killer controls over 200 grassy and broadleaf weeds including Crabgrass and Foxtail. Intended for use on established lawns including Bermuda, Buffalo, Kentucky Bluegrass and more. For best results apply in spring or early summer when weeds are small and actively growing.



Item #	Desc	UPC	Vendor	CS/UOS	Location
82280098	16oz Conc. Not For Sale AK, DC, DE, HI, MD, ME, NV, NY, PR, VI, WI, WV	732221110304	11030	12/12	East
82280099	RTS 32oz Not for Sale AK, DE, HI, MD, NV, NY, PR, VI, WI	732221110311	11031	12/12	East
82280101	RTU 32oz Not For Sale AK, DC, DE, HI, MD, ME, MT, NY, PR, VI, WI, WV	732221110366	11036	12/12	East

Hi-Yield®

Kill-A-Bug II Lawn

For use in lawns, around house foundation, under shrubbery and other ornamental recreational turf grass areas. Provides control of armyworms, ants, ticks, chinch bugs, crickets, grasshoppers, spiders, scorpions, cockroaches, european crane fly larvae and many other listed insects. **Not For Sale AK, CA, DC, HI, MA, MD, ME, MN, NE, NJ, PR, RI, VI, WI**



Item #	Desc	UPC	Vendor	CS/UOS	Location
82280267	10 lb.	732221323155	32315	1/1	East
82280268	20 lb.	732221323162	32316	1/1	East

Hi-Yield®

2, 4-D

This product will kill or control many Broadleaf Weeds in addition to many other noxious plants susceptible to 2, 4-D. **Not For Sale AK, CA, DC, HI, MA, ME, NJ, PR, RI, VI, WA, WI**



Item #	Desc	UPC	Vendor	CS/UOS	Location
82280185	16oz Concentrate	732221214149	21414	12/12	East
82280186	32oz Concentrate	732221214156	21415	12/12	East
82280187	1 gal Concentrate	732221214163	21416	4/4	National

Indoor/Outdoor Broad Use Insecticide

Indoor insects controlled: Termites, Fleas, Ticks, Carpet Beetles, Cockroaches, Waterbugs, Palmetto Bugs, Ants, Silverfish, Firebrats, Spiders, Crickets, Millipedes, Centipedes, Mites, Weevils, Beetles, Flies and Carpenter Ants. **Not For Sale AK, CA, DC, HI, MA, NY, PR, RI, VI, WI**



Item #	Desc	UPC	Vendor	CS/UOS	Location
82280212	8oz Concentrate	732221320086	32008	12/12	East
82280213	16oz Concentrate	732221320093	32009	12/12	East

38 Plus Turf Termite & Ornamental Insect Control

Controls home invading insects, lawn insects, insects on ornamentals plus trench and fence post termite recommendations. **Not For Sale AK, CA, HI, NY, PR, VI, WI**



Item #	Desc	UPC	Vendor	CS/UOS	Location
82280208	8oz Concentrate	732221313309	31330	12/12	East
82280209	16oz Concentrate	732221313316	31331	12/12	East

Turf & Ornamental

Use in ornamental landscape areas, established lawns and ornamental turf. Can be applied up to 4 weeks later than other preemergence crabgrass preventers. **Not For Sale AK, HI, MA, PR, VI, WI**



Item #	Desc	UPC	Vendor	CS/UOS	Location
82280281	9.6 lb.	732221330306	33030	1/1	National

Grub Free Zone

Other pests controlled (including the larvae of Japanese beetle, Oriental beetle, chafers, Asiatic garden beetle, May or June beetles, and black turfgrass ateniensis) and mole crickets. **Not For Sale AK, CA, CT, DC, DE, HI, IN, MA, MD, ME, MT, NJ, NV, NY, OR, PA, PR, RI, VI, VT, WI**



Item #	Desc	UPC	Vendor	CS/UOS	Location
82280287	15 lb.	732221330641	33064	1/1	East

Weed & Feed 15-0-10

Contains an effective post-emergent broadleaf weed killer in combination with lawn fertilizer. Controls Dandelion, Chickweed, Knotweed, Plantain, Henbit, Spurge and many other broadleaf weeds in Centipede, Bahia, Bermuda, Zoysia, Bluegrass, Perennial Ryegrass, Bentgrass and Fescue. Lawn should be moist before application and product should be watered in 24 hours after application.

Not For Sale AK, HI, MA., PR, VI, WI



Item #	Desc	UPC	Vendor	CS/UOS	Location
82280297	18 lb.	732221334083	33408	1/1	National

Bug Blaster II

Provides broad spectrum control of insect pests in lawns, landscapes, perimeter around homes and buildings. 11.5 lb. bag treats up to 5,000 sq. ft. 23 lb. bag treats up to 10,000 sq. ft. Controls fireants, fleas, ticks, mole crickets, chinch bugs, European crane flies, scorpions and other listed insect pests. **Not For Sale AK, AZ, CA, HI, MA, PR, VI, WA, WI, WY**



Item #	Desc	UPC	Vendor	CS/UOS	Location
82280295	23 lb.	732221333277	33327	1/1	East

Bug Blaster Plus

An insecticide for above /below ground insects in lawns, flower beds, ornamentals, trees and shrubs. Apply early to kill grubs and crane fly larvae or apply when above ground insects are present. **Not For Sale AK, CA, DC, HI, MA, MD, NJ, NV, NY, PR, RI, VI, VT, WI**



Item #	Desc	UPC	Vendor	CS/UOS	Location
82280275	20 lb.	73222324060	32406	1/1	East



Black Beauty Heat & Drought

Heat and Drought Resistant Grass Seed Mixture is our most heat and drought-tolerant grass seed mixture yet! It contains Texas Bluegrass and Black Beauty® turf-type tall fescues which makes it perfect for lawns located in the Transition Zone. Black Beauty® Heat and Drought Grass Seed can withstand very hot temperatures, up to 100°F, and requires less maintenance than other grass types.

Item #	Desc	UPC	Vendor	CS/UOS	Location
81430229	3 lb.	79545105143	10514	15/15	East
81430230	7 lb.	79545105150	10515	7/7	East

Black Beauty™ Grass Seed

Produces a darker-green turf naturally. With improved disease resistance and drought tolerance, Black Beauty Grass redefines what a “green-lawn” is supposed to look like! The grass leaves possess an invisible waxy coating, very similar to what you’d find on an apple which helps to preserve moisture in the leaf and wards off stress from heat, cold, wind and disease. With roots that can grow up to four feet deep into the soil, it will improve any lawn it is overseeded into. This blend grows well in clay or sandy soils and in full sun or partial shade.

Item #	Desc	UPC	Vendor	CS/UOS	Location
81430020	5 lb.	079545103187	10318	10/10	National
81430021	15 lb.	079545103170	10317	3/3	National
81430022	25 lb.	079545103156	10315	1/1	National
81430023	50 lb.	079545103163	10316	20/1	East

Black Beauty Sunny

Will provide a long-lasting lawn of the highest quality in stressful, sunny growing conditions. Survives on south facing slopes. Highest ranking endophytic turfgrass varieties deter damage from insects.

Item #	Desc	UPC	Vendor	CS/UOS	Location
81430036	1 lb.	079545108953	10895	24/24	East
81430037	3 lb.	079545108601	10860	15/15	East
81430253	3 lb.	079545108601	10861	6/6	West
81430038	7 lb.	079545108809	10880	7/7	National
81430040	25 lb.	079545108700	10870	40/1	National

Black Beauty Shady Nooks™ Mixture

Especially made to survive in damp or dry shady areas. Works well under extremely dense tree shade. Contains Hard Fescue for dry areas in deep shade.

Item #	Desc	UPC	Vendor	CS/UOS	Location
81430045	3 lb.	079545119577	11957	15/15	East

Black Beauty Sun & Shade

Will grow a thick, dark-green lawn in both sun and partial shade areas. Wide adaptability and elite varieties make this our most popular grass seed mixture. Endophyte enhanced for improved insect resistance.

Item #	Desc	UPC	Vendor	CS/UOS	Location
81430048	1 lb.	079545120016	12001	24/24	East
81430014	3 lb.	079545120023	12002	15/15	East
81430254	3 lb.	079545120023	12008	6/6	West
81430050	7 lb.	079545120054	12005	7/7	National
81430051	15 lb.	079545120047	12004	3/3	East
81430052	25 lb.	079545120061	12006	40/1	National

Black Beauty Dense Shade

Grows in shady areas and dry soils where other seed mixtures have failed. Contains naturally insect resistant endophytic turfgrass varieties, which helps to deter insect pests. Contains several grass types for species diversity.

Item #	Desc	UPC	Vendor	CS/UOS	Location
81430028	1lb.	079545106225	10622	24/24	National
81430029	3 lb.	079545106003	10600	15/15	East
81430252	3 lb.	079545106003	10601	6/6	West
81430030	7 lb.	079545106201	10620	7/7	National
81430032	25 lb.	079545106102	10610	40/1	East

Black Beauty™ Ultra Grass Seed

Black Beauty Ultra germinates quickly to fill in damaged lawns. This grass possesses species diversity and contains Black Beauty Tall Fescues, elite Kentucky Bluegrass and elite Perennial Ryegrass. These grasses grow a naturally dark green and beautiful lawn. This mixture has excellent heat and drought tolerance.

Item #	Desc	UPC	Vendor	CS/UOS	Location
81430024	1 lb.	079545103200	10320	24/24	East
81430013	3 lb.	079545103217	10321	15/15	National
81430251	3 lb.	079545193217	10325	6/6	West
81430026	7 lb.	079545103224	10322	7/7	National
81430027	25 lb.	079545103231	10323	1/1	National



Black Beauty Fall Magic

Specially formulated for successful fall seeding. This mixture is good to use on established lawns or to start new lawns. Repairs summer damage and provides an attractive, thicker, greener lawn.

Item #	Desc	UPC	Vendor	CS/UOS	Location
81430033	3 lb.	079545107659	10765	15/15	National
81430034	7 lb.	079545107680	10768	7/7	National

Black Beauty Heavy Traffic

A hardy mixture of grasses for tough areas with hard wear. Black Beauty Tall Fescues and Perennial Ryegrass offers quick cover and excellent abrasion resistance. Use where children and pets play.

Item #	Desc	UPC	Vendor	CS/UOS	Location
81430041	3 lb.	079545109707	10970	15/15	National
81430042	7 lb.	079545110000	11000	7/7	National

Black Beauty Golden State Mix

Specially formulated for California lawns. Extreme drought and heat tolerance up to 100°F. Premium mixture of turf-type tall fescues and Texas Bluegrass. Grows dark green, drought-resistant, and highly durable lawns. Grows well in both sunny and/or shady areas.

Item #	Desc	UPC	Vendor	CS/UOS	Location
81430250	3 lb.	079545107000	10702	6/6	West
81430228	7 lb.	079545107017	10701	7/7	West
81430260	50 lb.		N40005	1/1	West

Black Beauty Pacific Northwest

All-purpose grass seed mixture specifically designed for the diverse climates of the Pacific Northwest, including Washington, Oregon and Idaho. Black Beauty® Pacific Northwest Grass Seed thrives in full sun to medium-shaded lawn areas and grows an attractive, naturally dark-green lawn.

Item #	Desc	UPC	Vendor	CS/UOS	Location
81430242	3 lb.	079545103668	10364	6/6	West
81430243	7 lb.	079545103668	10366	7/7	West

Veri-Green Seeding & Sodding 12-18-8

Green-Up Fertilizer for Seeding & Sodding has been specifically formulated to grow quicker and thicker grassroots which are essential for surviving the stresses of summer and winter. This product also contains humates that enhance the efficiency, availability, and exchange of plant nutrients to and from the soil.

Item #	Desc	UPC	Vendor	CS/UOS	Location
81430237	1.5M	079545160074	16006	12/12	National
81430238	5M	079545160074	16007	1/1	National
81430239	15M	079545160081	16008	1/1	East

Veri-Green Crabgrass Preventer 20-0-3

A high-quality lawn food that contains a crabgrass preventer to help eliminate crabgrass before it has a chance to grow. Designed to provide a long-lasting green lawn while also controlling the growth of unwanted weeds and crabgrass. Made with slow-release nitrogen that provides a steady supply of nutrients to your lawn over an extended period.

Item #	Desc	UPC	Vendor	CS/UOS	Location
81430231	5M	079545160005	16000	1/1	National
81430232	15M	097545160012	16001	1/1	National

Veri-Green Lawn Food 29-0-3

An ideal balance of fertilizer for high-quality turf requirements. Features Green-Meter Technology with 40% slow-release nitrogen that continually feeds the turf for 10 to 12 weeks. Nitrogen release is unaffected by excessive rainfall, thereby reducing grass clippings. Uniform particle size for even distribution. Contains 3% iron and 1% sulfur to help lawns resist drought and disease. Contains humates for root development.

Item #	Desc	UPC	Vendor	CS/UOS	Location
81430235	5M	079545160043	16004	1/1	National
81430236	15M	079545160050	16005	1/1	National

Veri-Green Weed & Feed 21-0-3

Lawn fertilizer and weed killer in one. 3-way action provides superior weed control. Slow release nitrogen fertilizer with polymer-coated technology. Fine particle size for superior weed control feeding action. Greens the lawn in cooler temperatures. Do not apply during hot, dry weather when turf is under stress.



Item #	Desc	UPC	Vendor	CS/UOS	Location
81430233	5M	079545160029	16002	1/1	National
81430234	15M	079545160036	16003	1/1	National

2025



MAG-I-CAL® Plus For Alkaline & Hard Soils

A highly soluble form of calcium that helps to rapidly raise your soil's pH, improving the health of your lawn by releasing trapped nutrients in the soil that feed the grass plants.



Item #	Desc	UPC	Vendor	CS/UOS	Location
81430180	5M	079545122003	11356	1/1	East
81430181	15M	079545122010	11357	1/1	East

MAG-I-CAL® Calcium Fertilizer

A highly soluble form of calcium that helps to rapidly raise your soil's pH, improving the health of your lawn by releasing trapped nutrients in the soil that feed the grass plants.



Item #	Desc	UPC	Vendor	CS/UOS	Location
81430153	5M	079545113537	11353	1/1	East
81430154	15M	079545113520	11352	1/1	East

MAG-I-CAL® Plus For Acidic & Hard Soils

Poor soil is often the problem in growing a great lawn and calcium is vital to many grass plant functions. When soil is compacted or too acidic, air, water, and nutrients are unable to reach the roots, making it very difficult for grass to flourish.



Item #	Desc	UPC	Vendor	CS/UOS	Location
81430178	5M	079545113544	11354	1/1	East
81430179	15M	079545113544	11355	1/1	East

Love Your Soil

Love Your Soil assists in breaking up clay and loosens compacted soils, which improves root penetration, grass growth, and root mass. Because hard and compacted soil is often the problem when it comes to growing a great lawn, this product is designed to help release nutrients trapped in the soil for premium grass growth.



Item #	Desc	UPC	Vendor	CS/UOS	Location
81430156	5M	079545121907	12190	100/10	West

Summer Survival Insect Control plus Lawn Fertilizer 13-0-3

Controls a wide spectrum of insect pests including chinch bugs, army worms, sod webworms, ticks, ants, and over 15 other insects with Bifenthrin. Slow-release nitrogen provides a controlled release feeding. No phosphorus formula makes it great for lake and bay communities.



Item #	Desc	UPC	Vendor	CS/UOS	Location
81430016	5M	079545120115	12011	130/1	East
81430105	15M	079545120153	12015	45/1	East

Winter Survival 10-0-20

Winter survival is a high potassium (K) fertilizer that is perfectly formulated (10-0-20) for the fall season. Winter Survival helps prepare lawns for winter and protects them from spring diseases, like snow mold and red thread.



Item #	Desc	UPC	Vendor	CS/UOS	Location
81430005	5M	079545124007	12400	130/1	East
81430107	15M	079545124144	12414	45/1	East

Black Beauty Seedroll

Contains Black Beauty seed and starter food. Biodegradable mat grows seed in 10-5 days. Grows well in sunny or shady areas. Protects seed from erosion and wildlife. Covers 50 sq ft.



Item #	Desc	UPC	Vendor	CS/UOS	Location
81430212	50 sq ft	079545104108	10410	6/6	East

New American Lawn® Hand Spreader

Hand Spreader is ideal for spreading grass seed, fertilizers, and ice melters. Easy and comfortable to use, the ergonomic handle allows the weight to be supported by the operator's forearm, preventing back injuries.

The spreader is fully assembled and is made of lightweight, corrosion resistant materials. Great to use on lawns, gardens, driveways and sidewalks.



Item #	Desc	UPC	Vendor	CS/UOS	Location
81430188	50 sq ft	079545109479	10947	6/6	East



Fast Grow Mixture

Provides a hardy turf quickly in sun and shade. This is the perfect seed mixture where the fastest results are required. Germinates in just 7-14 days!



Item #	Desc	UPC	Vendor	CS/UOS	Location
81430053	3 lb.	079545108205	10820	15/15	National
81430054	7 lb.	079545108403	10840	7/7	East
81430055	15 lb.	079545108304	10830	3/3	National
81430056	25 lb.	079545108106	10810	40/1	East

Touch-Up Tri-Rye Grass Seed Blend

Contains quick-germinating turf-type perennial ryegrasses. Touch-Up™ bare spots or overseed your entire lawn with this golf course quality mixture.



Item #	Desc	UPC	Vendor	CS/UOS	Location
81430061	3 lb.	079545121204	12120	15/15	East

Organic Grub & Insect Control

Kills and repels lawn pests including grubs, fleas, ticks, ants chinch bugs and more. Easy to spread granules. Treats up to 5000 square feet. The active ingredients consist of a proprietary blend of 3 essential plant oils, making it an effective insecticide that is environmentally friendly. It is also safe for use around children and pets when used as directed.



Item #	Desc	UPC	Vendor	CS/UOS	Location
81430240	5M	079545119256	11925	1/1	East

Winter Rye Grass Seed

Winter Rye is a cover crop that enriches the soil. For use in gardens, pastures and hay fields. Use as a cover crop to control erosion.



Item #	Desc	UPC	Vendor	CS/UOS	Location
81430080	5 lb.	079545123918	12391	10/10	West

White Clover

White Clover Seed is the perfect choice for lawns, gardens and meadows, providing long-lasting coverage for weed control, attractive greenspace, and a rich source of protein for birds, Honey Bees, and beneficial insects. This clover seed is specifically designed to thrive in shade, sun and wet areas, and germinates quickly, offering a lush and vibrant covering. Coverage 1,500 Sq Ft



Item #	Desc	UPC	Vendor	CS/UOS	Location
81430079	1 lb.	079545123819	12381	24/24	East

Pasture Grass Mixture

Pasture Mixture is the best choice for grazing horses and other livestock because these grasses are free of endophytes which have been known to cause illness if the majority of their diet contains endophytic turfgrasses. This seed germinates 10 - 21 days.



Item #	Desc	UPC	Vendor	CS/UOS	Location
81430078	50 lb.	079545116200	11620	20/1	West

Wildflowers and Meadow Grass Mixture

Contains over 25 wildflowers plus Hard Fescue and Birdsfoot Trefoil to create a pleasant meadow effect. Good for slopes and low maintenance areas that you don't want to mow. One pound covers up to 1,000 sq ft.



Item #	Desc	UPC	Vendor	CS/UOS	Location
81430064	1 lb.	079545123840	12384	18/18	East

Season-Long Weed Preventer For Lawn & Landscapes

Crabgrass and weed preventer provides great control of crabgrass and other grassy weeds. contains Dimension (r) for season-long control. does not contain fertilizer. for use on cool and warm season grasses to control or suppress many annual grasses and broadleaf weeds. Can be applied up to 4 weeks later than other pre-emergence crabgrass preventers. Labeled for use on over 100 ornamentals.



Item #	Desc	UPC	Vendor	CS/UOS	Location
81430186	5M	079545123604	12360	1/1	East



Lawn Moss Control

Kills lawn moss quickly. Easy to spread, small particle granules for improved performance. 50% more active ingredient per 5,000 sq. ft. bag versus other brands for superior control. Delay seeding for two weeks after application.



Item #	Desc	UPC	Vendor	CS/UOS	Location
81430122	5M	079545114572	11457	1/1	East

Lawn Fungus Control

A systemic fungicide for both preventative and curative treatments. Controls more than 20 lawn diseases including summer patch, fusarium blight, dollar spot, copper spot, red thread, rust, striped smut, pink snow mold. Easier to spread accurately for better coverage and control. You may seed with this product.



Item #	Desc	UPC	Vendor	CS/UOS	Location
81430120	5M	079545102333	10233	1/1	East

Contractor's Mix Grass Seed

Our cool-season grass seed is ideal for soil stabilization or temporary lawn seeding. It's a great option for quick coverage and erosion control.



Item #	Desc	UPC	Vendor	CS/UOS	Location
81430072	25lb.	079545114589	11458	40/1	East
81430073	50lb.	079545114602	11460	20/1	National



Tree Saver

A granular soil amendment with beneficial bacteria and mycorrhizal fungi. For planting and transplanting trees, shrubs and mycorrhizae, help meal and humic acids to improve soil and plant health. Contains a total of 150 - 3oz packs. **Not For Sale AR, CA, DE, HI, IL, OK, PR, SD, NB**



Item #	Desc	UPC	Vendor	CS/UOS	Location
80350442	150 X 3oz	88685565694	2756658	1/1	East



Pollinator Wildflower Mix

This premium pollinator mix bag attracts bees, butterflies and hummingbirds. Easy to grow and covers up to 500 square feet, this wildflower shaker bag by Ferry-Morse contains a seed mixture that allows you to feed various pollinators. From this blend of 20 annual and perennial flowers you will see early, mid and late-season blooms that will provide both long and short-tongued bees with nectar and pollen all season long. Ferry-Morse seed, the most trusted brand since 1856.



Item #	Desc	UPC	Vendor	CS/UOS	Location
81870065	7 oz	71953965265	WFPOL18	18/18	National



Starter Fertilizer 10-0-0

Monterey Starter Fertilizer encourages root development and is excellent for gardens, ornamental plants, bedding plants, lawns, trees, shrubs, vegetables, and fruit trees. Additionally, this fertilizer includes calcium, which helps avert the blossom end rot issue commonly encountered in tomatoes. **Not For Sale AR, KY, MD, MO, MS, MT, ND, NE, SC, SD, VT, WV, WY**



Item #	Desc	UPC	Vendor	CS/UOS	Location
80820346	Quart Concentrate	022179105386	LG 7368	10/10	West

Turf Booster 18-2-2

Keeps turf green. Contains 3 forms of nitrogen. Encourages a vigorous root zone. Available in easy-to-use RTS (Ready-to-Spray) packaging. Simply attach it to a garden hose, point, and spray! **Not For Sale AR, KY, MD, MO, MT, ND, NE, SC, SD, VT, WI, WV, WY**



Item #	Desc	UPC	Vendor	CS/UOS	Location
80820401	32oz RTS	022179105539	LG 7378	10/10	National



Pulverize Weed Killer for Lawns

Pulverize® Weed Killer for Lawns uses the active ingredient iron to selectively control/suppress broadleaf weeds growing in lawns. Dogs, pets and people can enter the area after product has dried. Works fast, even in cold weather, and results will be seen in hours. Includes active ingredients Ammoniated Soap of Fatty Acids and Iron HEDTA that eliminates weeds while preventing damage to grass.



Item #	Desc	UPC	Vendor	CS/UOS	Location
81490152	32oz with Trigger	813935009501	PW-U-032	6/6	West

Pulverize Weed & Grass Killer

Pulverize® Weed and Grass Killer is a fast acting, weed, grass, algae and moss killer. Incidental over spray will not stain concrete or pavement. Pulverize Weed and Grass Killer is a non-selective herbicide that controls many common annual weeds. Pulverize Weed and Grass Killer suppresses the growth of some bi-annuals and perennial weeds. Active ingredients Ammoniated soap of Fatty Acids 3.68% Other ingredients 96.32%



Item #	Desc	UPC	Vendor	CS/UOS	Location
81490163	1 qt. Concentrate	813935009570	PWG-C-032	6/6	West
81490159	32oz Weed & Grass Killer RTU	813935009525	PWG-U-032	6/6	West



Pulverize Weed Brush & Vine Killer

The Pulverize Weed, Brush & Vine Killer formula is a powerful, fast and effective alternative to those other brand name weed killers. Destroy pesky weeds, brush and vines down to the roots and see results in just a few hours! Active ingredients Ammoniated salts of fatty acids to burn down weeds and Maleic hydrazide to prevent regrowth.

Item #	Desc	UPC	Vendor	CS/UOS	Location
81490170	1 qt. Concentrate	813935009594	PWBV-C-032	6/6	West
81490166	32oz with Trigger	813935009549	PWBV-U-032	6/6	West
81490217	1 Gal with Trigger	813935009631	PWBV-UT-128	4/4	West



All Purpose Fertilizer

Milorganite fertilizer is one of the oldest branded fertilizers on the market today. It is composed of heat-dried microbes that have digested the organic matter in wastewater. It is non-burning, does not need to be watered in, has iron for greening and has been used on golf courses since 1926.



Item #	Desc	UPC	Vendor	CS/UOS	Location
81580002	5 lb.	465396200502	MILOR05	10/10	East
81580003	32 lb.	465396403241	MILORG32	63/7	National



Lawn Weed & Disease Control

Kills listed weeds including Dandelion, Common Chickweed, Clover, and more down to the root. Fungicide controls Rust, Dollar Spot, Lichens, and more. Also kills moss, algae, and lichens in turf. Can be applied in cooler weather (down to 50 degrees) during non-traditional weeding times. 26.52% Iron HEDTA (FeHEDTA)



Item #	Desc	UPC	Vendor	CS/UOS	Location
82270060	RTS 24oz (non-neonic)	687073074109	707410D	4/4	National
82270059	24oz (non-neonic) Restricted CA	687073073102	707310D	4/4	National

Grass & Weed with Root Kill

This product is a fast-acting herbicidal soap that eliminates unwanted vegetation. It can be used in planting beds prior to planting grass, flowers or vegetables and around ornamental flowers and mature shrubs and trees. Kills listed weeds and grasses, including Dandelion, Chickweed and others. Fast-acting! 3.68% Ammoniated soap of fatty acids 0.50% Maleic Hydrazine



Item #	Desc	UPC	Vendor	CS/UOS	Location
82270062	RTU 24 oz	687073072006	707200A	4/4	National
82270061	RTU 1 Gal (non-neonic)	687073072013	707201A	4/4	National



Milky Spore Spreader Mix

Milky Spore Granular is an organic and powerful solution for controlling Japanese Beetle grubs. Once ingested by a grub, a single spore multiplies into billions, returning to the soil as the grub decomposes, creating a lasting defense for years of eco-friendly pest control. Safe for use around waterways, people, animals, and beneficial insects. For optimal results, apply Milky Spore Granular anytime the ground is not frozen. 15 LB bag treats 5,250 sq. ft.”



Item #	Desc	UPC	Vendor	CS/UOS	Location
80660087	15lb.	699064800154	80015-4	1/1	East

Milky Spore Powder

Milky Spore Powder is an organic and powerful solution for controlling Japanese Beetle grubs. Once ingested by a grub, a single spore multiplies into billions, returning to the soil as the grub decomposes, creating a lasting defense for years of eco-friendly pest control. Safe for use around waterways, people, animals, and beneficial insects. For optimal results, apply Milky Spore Powder anytime the ground is not frozen. 40 oz treats 10,000 sq. ft.”



Item #	Desc	UPC	Vendor	CS/UOS	Location
80660032	10 oz	699064800109	80010-9	6/6	East
80660034	40 oz	699064800406	80040-6	6/6	East



Lawn & Garden Dispenser

Keep your lawn, yard, or home garden pest free and growing strong with the St. Gabriel Organics Lawn and Garden Pest Control and Fertilizer Dispenser Tube. Designed to disperse the milky spore powder by St. Gabriel Organics, this dispenser tube can also be used with insect dust or fertilizers.

Item #	Desc	UPC	Vendor	CS/UOS	Location
80660035	2 lb	699064800017	80001-7	12/12	East



Rid Moss Spring Feed & Moss Control

Helps build the lawn after winter dormancy. Kills moss and feeds lawn in 1 easy application. Multistage, time release nitrogen provides long lasting lawn nutrition.



Item #	Desc	UPC	Vendor	CS/UOS	Location
82530038	20lb	082567030300	WNL03030	70/10	West

Rid Moss

The strongest moss kill available! 14% moss killing iron combined with 7% Nitrogen to help thicken and green grass. Safe for lawns and flower beds.



Item #	Desc	UPC	Vendor	CS/UOS	Location
82530036	5lb Shaker Bag	082567030287	WNL03028	6/6	West
82530040	20lb Bag	082567030218	WNL03027	70/10	West

Weed & Feed

Feeds your lawn for up to 12 weeks! Greens lawns and helps develop deep roots while controlling weeds. Triple action feeding works at every level; grass, roots and soil.



Item #	Desc	UPC	Vendor	CS/UOS	Location
82530039	30lb	082567030348	WNL03034	63/9	West

Structural Rid Moss

Non-staining, non-corrosive formula that quickly kills moss and is safe for use on roofs, patios, brick and cement.



Item #	Desc	UPC	Vendor	CS/UOS	Location
82530037	5lb	082567030294	WNL03029	9/9	West

TOOLS & EQUIPMENT



CHECK OUT OUR
CLEARANCE ITEMS!



Griffin Greenhouse Retail WAREHOUSE Shipping Map

We are now shipping nationwide!

2025

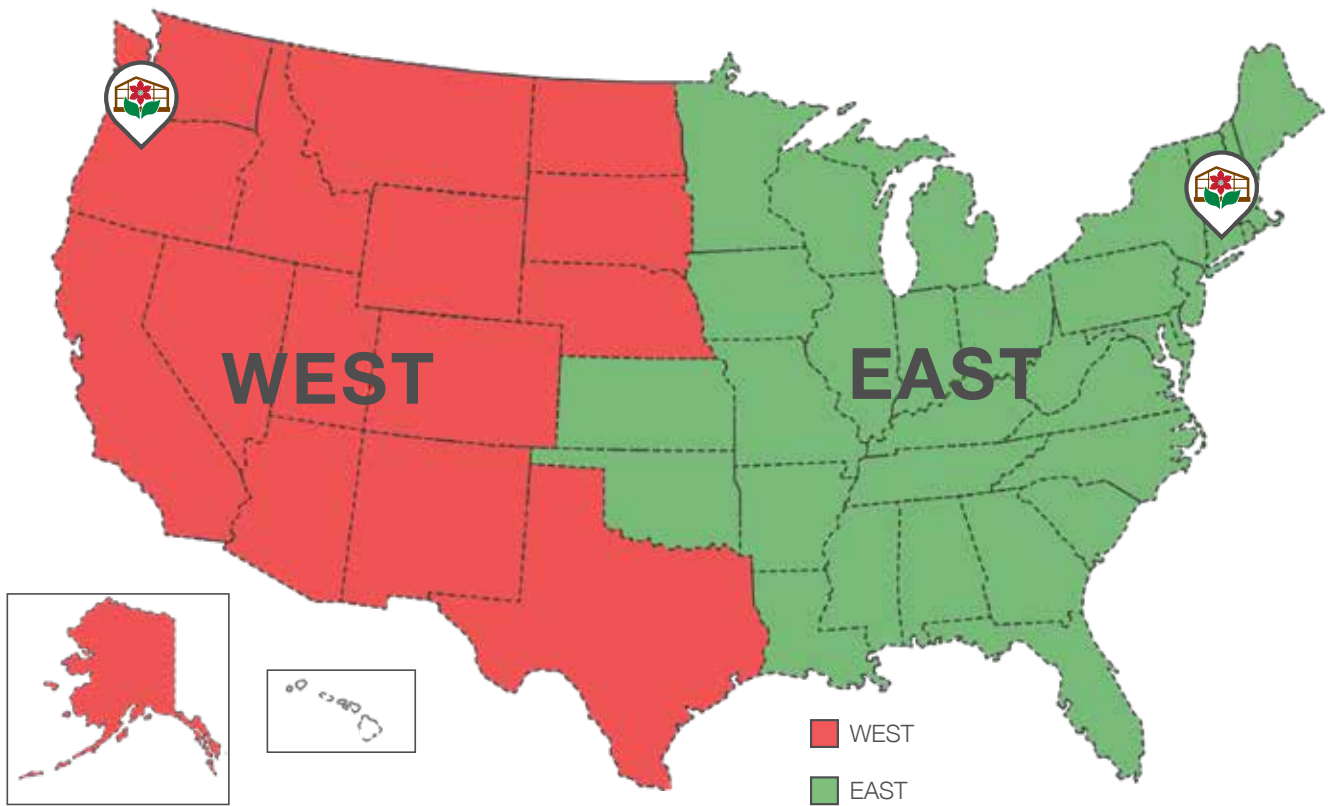

Refer to location key:

National items are stocked nationally
 Select items are sold East or West only; no exceptions

8" Kaleidoscope Planter

Premium plastic modular planter can be displayed individually each planter has a removable saucer ideal for succulents or shallow rooted planted.

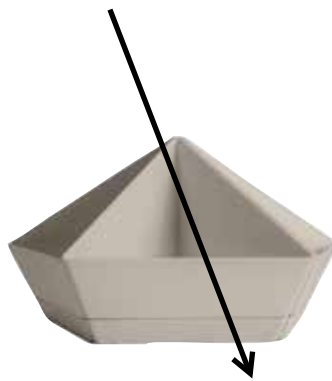

Item #	Desc	UPC	Vendor	CS/UOS	Location
80282643	Vanilla Bisque	770932844170	KDP08000A58	6/6	National

Where is the pricing?

1. Scan QR code on Chapter Pages to see pricing on Griffins.com
2. Contact your Griffin Sales Representative
3. Call into Griffin Customer Service 800.888.0054





Leaf Rake w/ Long Fiberglass Handle

The perfect tool to easily rake large quantities of leaves, grass, and other lawn and yard waste. The 26 tines are constructed from a top-grade lightweight polypropylene that makes it easy and comfortable to use for any job.



Item #	Desc	UPC	Vendor	CS/UOS	Location
82410093	24 tine Rake	817085011810	LRK002	6/6	National

Flex-Steel Rake w/ Aluminum Handle

To create the healthiest environment for your lawn, your grass and soil need to breathe and receive water. Regular lawn raking will remove thatch and grass clippings that deprive your soil of oxygen and water. This rake is the #1 choice for professional gardeners. 48" Aluminum handle



Item #	Desc	UPC	Vendor	CS/UOS	Location
82410102	8" FlexRake	017849190328	3A	12/12	National
82410100	19" FlexRake	107849190120	1A	12/12	National

Flex-Steel Rake w/ Wood Handle

To create the healthiest environment for your lawn, your grass and soil need to breathe and receive water. Regular lawn raking will remove thatch and grass clippings that deprive your soil of oxygen and water. This rake is the #1 choice for professional gardeners.



Item #	Desc	UPC	Vendor	CS/UOS	Location
82410101	8" FlexRake Wood	017849190311	3W	12/12	National
82410099	19" FlexRake Aluminum Handle	017849190113	1W	12/12	National

Hula-Ho Weeder

Quite simply, the heat treated, self-sharpening Hula-Ho blade works beneath the surface of the soil. The almost effortless back and forth "hula" motion cuts weeds at the roots. Meanwhile, the weeds and soil blend to create a healthy mulch.



Item #	Desc	UPC	Vendor	CS/UOS	Location
82410104	Mini Hula-Ho 14" Wooden Handle	017849005004	500W	24/24	National
82410103	Hula-Ho w/54" Wooden Handle	010781104996	1000L	12/12	National

Root Slayer - Garden shovel

Root Slayer is a garden shovel with a specially shaped blade. The spade has a pointed shape and sharp teeth on both sides. This gives you extra power to push the spade deep into the ground, even if the ground is dry and hard. In addition, the spade is multifunctional so that you can effortlessly uproot plants, saw, move or transplant trees and plants.



Item #	Desc	UPC	Vendor	CS/UOS	Location
82410017	Root Slayer	817085014996	22011	5/5	National

BOSMERE

Tub Trugs

The flex buckets are great for carrying needs like job-site tools, landscaping, catering, yard clean up, laundry basket, livestock feeder, trunk organizer, concrete mixing and much more. 3 of each color per case pack. Colors are red, green, blue, and pistachio.



Item #	Desc	UPC	Vendor	CS/UOS	Location
82010656	3.7 gal	721082074047	G404	12/12	National
82010258	6.8 gal	721082074146	G414	12/12	National
82010657	9.9 gal	721082074245	G424	12/12	National

Hand Leaf Grabs

These Hand Leaf Grabs makes it quick and easy to pick up leaves and other debris from your garden. Strong and durable, these leaf grabs are supplied in a one size fits all and will become a favourite garden tool you'll wonder how you survived without.



Item #	Desc	UPC	Vendor	CS/UOS	Location
82010632	14"	013554144552	N455	10/10	National

CENTURION®

Quality, Value & Innovation

All-Aluminum Die Cast Tools

This beautiful all-aluminum die-cast body is both strong and beautiful. Its polished surface keeps the tools clean and looking beautiful for years to come. The all-aluminum body is made to withstand the most demanding use. The handles are large with a hanging hole for easy storage. Its non-slip grip is perfect for gardeners who have difficulty holding gardening tools with small or narrow handles. The perfect balance between beauty, durability, comfort and control. Makes an elegant gift for any gardening enthusiast.



Item #	Desc	UPC	Vendor	CS/UOS	Location
82760009	Trowel	845049001645	164	12/12	National
82760010	Transplanter	845049001652	165	12/12	National
82760011	Cultivator	845049001669	166	12/12	National

2025

33 Gallon Multi-Purpose Collapsible Bag

This 33 gallon Pop-Up bag can easily be used indoors or outdoors and is an ideal way to reduce your impact on the environment. It's the perfect companion for the outdoorsman for camping, tailgating, backyard BBQ's, picnics, beach trips, cookouts, yard waste, garage recycling and more. Also ideal for indoor parties, craft rooms, laundry rooms or to use for recycling.



Item #	Desc	UPC	Vendor	CS/UOS	Location
82760058	33 gal	845049008224	822	12/12	National



Sprayer

Pressure Sprayer for indoor and outdoor use, this sturdy sprayer is compatible with most commercial liquid fertilizer, weed killers, herbicides, pesticides, mild cleaning solutions and bleach.

Item #	Desc	UPC	Vendor	CS/UOS	Location
82760059	1/2 gal	845049008415	841	8/8	National
82760060	1 gal	845049008422	842	6/6	National
82760061	2 gal	845049008439	843	6/6	National



Long Handle Steel 24 Tine Rake

Bolted carbon steel head. Build-in spring brace for more power. 59 inch fiberglass handle for extra reach.

Item #	Desc	UPC	Vendor	CS/UOS	Location
82760158	Fiberglass	845049063841	6384	6/6	National



Long Handle Wiggle Weeder

Durable Grip with Hanging Hole. Head double bolted for secure handle connection. Looped steel blade allows for push and pull action.

Item #	Desc	UPC	Vendor	CS/UOS	Location
82760157	Fiberglass	845049062813	6281	6/6	National



D-Handle Round Point Shovel

Poly D-Grip Handle. Tempered steel blade. Forward-turned step for secure foot placement. durable chrome plated steel coupling.

Item #	Desc	UPC	Vendor	CS/UOS	Location
82760156	Fiberglass	845049062806	6280	6/6	National



Long Handle Round Point Shovel (A)

Tempered steel blade. Forward-turned step for secure foot placement. Comfort grip with hanging hole. Durable chrome plated steel coupling.

Item #	Desc	UPC	Vendor	CS/UOS	Location
82760147	Fiberglass	845049062714	6271	6/6	National

Long Handle 4-Tine Cultivator (D)

Durable steel construction. Sharp tip help cultivate through soil. Pinned connection between head and handle increases longevity and durability.

Item #	Desc	UPC	Vendor	CS/UOS	Location
82760150	Fiberglass	845049062745	6274	6/6	National

Long Handle Square Point Shovel (B)

Tempered steel blade. Forward-turned step for secure foot placement. Comfort grip with hanging hole. Durable chrome plated steel coupling.

Item #	Desc	UPC	Vendor	CS/UOS	Location
82760148	Fiberglass	845049062721	6272	6/6	National

Long Handle 14-Tine Bow Rake (E)

Laser-cut tines for precision. Durable tempered steel head. Pinned connection between head and handle increases longevity and durability.

Item #	Desc	UPC	Vendor	CS/UOS	Location
82760151	Fiberglass	845049062752	6275	6/6	National

Long Handle Garden Hoe (C)

Beveled blade edge for cleaner cutting. Durable steel construction. Pinned connection between head and handle increases longevity and durability.

Item #	Desc	UPC	Vendor	CS/UOS	Location
82760149	Fiberglass	845049062738	6273	6/6	National

Long Handle 3-Prong Cultivator (F)

Durable steel construction. Dual head for weeding and cultivating. Pinned connection between head and handle increases longevity and durability.

Item #	Desc	UPC	Vendor	CS/UOS	Location
82760152	Fiberglass	845049062769	6276	6/6	National



D-Handle Square Point Shovel

Durable tempered steel blade. Forward-turned step for secure foot placement. Durable chrome plated steel coupling.

Item #	Desc	UPC	Vendor	CS/UOS	Location
82760153	Fiberglass	845049062776	6277	6/6	National



D-Handle Round Point Shorty Shovel

Complete your landscaping, construction, and gardening projects with ease with centurion's shorty shovels. The hollow back round point shovel head is made from 15-gauge tempered steel for incredible strength and durability and the sturdy, handle is made from fiberglass. They are great for digging and gardening in tight spaces or when working on one's knees. Because of their compact size they are also ideal for camping and car storage for emergency use.

Item #	Desc	UPC	Vendor	CS/UOS	Location
82760056	Fiberglass	845049007616	761	6/6	National



D-Handle Drain Spade

Durable tempered steel blade. Durable chrome plated steel coupling. Arched blade for easy soil penetration. Forward-turned step for secure foot placement.

Item #	Desc	UPC	Vendor	CS/UOS	Location
82760155	Fiberglass	845049062790	6279	6/6	National

Stainless Steel Snips

The rust-resistant stainless steel construction provides long-lasting durability plus is very easy to clean and sterilize, even with heavy use. The convenient spring loaded handle design enhances speed, performance and makes cutting easier.



Item #	Desc	UPC	Vendor	CS/UOS	Location
82760016	Curved Snip	845049001966	196	10/10	National
82760017	Straight Snip	845049001973	197	10/10	National

All-Steel Anvil Pruner

5/8-inch diameter cutting capacity. The Classic All-Steel Anvil Pruner with sharp precision ground blades, specially bonded with a non-stick coating for superior cutting performance year after year.



Item #	Desc	UPC	Vendor	CS/UOS	Location
82760014	5/8" Pruners	845049001935	193	10/10	National

Bypass Pruner Aluminum Handles

Centurion's 8" Bypass pruner is constructed of aluminum alloy handles and hardened steel blades. Hardened steel blade and screw-mounted lower blade ensure reliably clean, precise cuts. Narrow pointed blade allows easy access to twiggy branches.



Item #	Desc	UPC	Vendor	CS/UOS	Location
82760072	8"	845049012252	1225	10/10	National

Mini Hedge Shear

6-inch blades. This is the tool to reach for when you need a precision cut! The six-inch blades are the perfect size for all of your detailed garden needs! The sharp precision ground hardened carbon steel blades are easy to maneuver and durable for all of your trimming needs. Handles are made of strong steel with comfortable contour molded, non-slip grips.



Item #	Desc	UPC	Vendor	CS/UOS	Location
82760023	5.5"	845049002093	209	12/12	National



D-Handle 4-Tine Spading Fork

Ergonomic poly d-grip. Durable tempered steel tine. Sharp tip help tilling and aerating soil.

Item #	Desc	UPC	Vendor	CS/UOS	Location
82760154	Fiberglass	845049062783	6278	6/6	National

Precision Bypass Pruner

Precision Bypass Pruner. Non-stick layer blade is sharp enough to cut tree branches. Convenient one hand control latch with thumb. Lightweight and ergonomic design save efforts and enjoy the garden work. Anti-slip TPR handles offer a firm and comfortable grips



Item #	Desc	UPC	Vendor	CS/UOS	Location
82760086	8"	845049015567	1556	10/10	National

Bypass Pruner

Non-stick coating keeps blades corrosion resistant and offers clean cut. Anti-slip and comfort feeling handles. Perfect pruner for a variety of cutting and pruning jobs.



Item #	Desc	UPC	Vendor	CS/UOS	Location
82760079	Pruner	845049012993	1299	10/10	National

Forged Bypass Pruner

Basic type drop-forged steel blade for sharpness and strength. Durable construction to help cut, trim with ease and efficiently. 5/8 inch cutting capacity. Comfortable non-slip soft grip handle.



Item #	Desc	UPC	Vendor	CS/UOS	Location
82760026	8"	845049002598	259	10/10	National

Mini Bypass Lopper

Mini-compound action bypass lopper. high carbon, heat treated non-stick upper blade with sharp cut. lightweight handle with soft touch grip.



Item #	Desc	UPC	Vendor	CS/UOS	Location
82760021	16"	845049002055	205	12/12	National



Level Head Aluminum Rake (A)

14" Level-head design for efficient, accurate tilling and leveling landscape materials, small head is ideal for working in close quarters. Extra-thick, tempered steel tines for greater strength and long service life. Flat head with straight tines for smooth tamping of seed beds. 60" Aluminum, oval-shaped handle with vinyl coating is lightweight.

Item #	Desc	UPC	Vendor	CS/UOS	Location
81380058	14"	038313640613	RK 64060	3/1	East

Bow Head Wood Handle Rake (B)

Tempered head for greater durability and long service life. Curved tines efficiently gather and move soil. Bow serves as spring for better control of tine depth. 60" Extra-long ash wood handle allows working in upright position, reduces back strain.

Item #	Desc	UPC	Vendor	CS/UOS	Location
81380232	16"	038313200213	RK 20002	3/1	National

Bow Head Fiberglass Rake (C)

Tempered 16-tine head for greater durability and long service life. Curved tines efficiently gather and move soil. Bow serves as spring for better control of tine depth. 60" Extra-long fiberglass handle with cushion grip allows working in upright position, reduces back strain.

Item #	Desc	UPC	Vendor	CS/UOS	Location
81380047	16"	038313200220	RK 20022	3/1	National

Poly Leaf Rake (D)

24" Poly head allows for medium-capacity leaf raking and general cleanup. 48" wood handle.

Item #	Desc	UPC	Vendor	CS/UOS	Location
81380051	24"	038313250249	RK 25024	12/12	National

Spring Brace Rake (E)

Fan-shaped head combines flexible tines with durability of metal. Stress distribution bar that prevents tines from twisting or breaking when pressed on. Coated frame and tines resist rust. 54" Long wood handle.

Item #	Desc	UPC	Vendor	CS/UOS	Location
81380233	22"	038313240028	RK 24002	12/12	National
81380048	24"	038313240035	RK 24003	12/6	National

Bigload Leaf Rake (F)

The unique head design maximizes load capacity and is both lightweight and durable. Optimized 60inch handle length allows for fuller leveraged strokes and more material moved per stroke. Get the leaves raked and move on to your next project with the Corona BigLOAD Leaf Rake.

Item #	Desc	UPC	Vendor	CS/UOS	Location
81380435	26"	038313450267	RK 45026	3/3	National
81380537	30"	038313450304	RK 45030	3/3	East

Razor Tooth Saw® Folding Saw

For small to medium branches. Up to 3" in diameter razor teeth for efficient cutting. Impulse hardened razor teeth cut up to 3" diameter. Convenient hanging hole.



Item #	Desc	UPC	Vendor	CS/UOS	Location
81380245	Folding Straight Blade	038313004071	RS 7041	6/1	East
81380060	7" Comfort Grip	038313072452	RS 7245	6/6	National

Landscape Rake Aluminum Handle

All-aluminum construction combines durability with ease of use during finish grading process. Angled, extra-thick tine tips for long service life. 60" in lightweight aluminum handles with non-slip vinyl sleeves for gripping comfort in extreme heat or cold.



Item #	Desc	UPC	Vendor	CS/UOS	Location
81380054	24" Head	038313610616	RK 61061	1/1	West
81380235	30" Head	038313640637	RK 61063	1/1	West



Classic Cut® Bypass Pruner (A)

Fully forged steel construction for maximum strength, resharpenable blade with non-slip grips for better control. BP 3130 is specifically designed for smaller hands.

Item #	Desc	UPC	Vendor	CS/UOS	Location
81380005	½"	038313000080	BP 3130	6/6	National
81380006	¾"	038313000608	BP 3160	6/6	National
81380007	1"	038313000806	BP 3180D	6/6	National
81386722	1" Branch & Stem	038313151805	BP15180	6/6	East

Comfortgel Anvil Pruner (B)

Branch & stem pruner with ComfortGEL® grips for superior comfort and less hand fatigue. Most suitable for cutting hard, dead wood up to 3/4 in.

Item #	Desc	UPC	Vendor	CS/UOS	Location
81380647	3/4"	038313033347	AP 3334	6/6	East

Forged Pro Cut Bypass Pruner (C)

The high-performance dual arc blade coating reduces cutting effort by 25% when compared to titanium-coated or non-coated blades.

Item #	Desc	UPC	Vendor	CS/UOS	Location
81380156	1" blades	038313107208	BP 7200	6/6	East

ComfortGEL® Bypass Pruner (D)

ComfortGEL soft, ergonomically shaped grips for maximum comfort, fit and control. Integrated Shock-Guard® bumpers reduce strain and fatigue. Specially coated, non-stick blades helps maintain maximum sharpness. Enhanced cutting performance and lightweight construction. Easy-open lock and accommodates right- and left-handed users.

Item #	Desc	UPC	Vendor	CS/UOS	Location
81380008	¾"	038313032142	BP 3214D	6/6	National

Thinning Shears (E)

Forged steel alloy construction. Scissor cutting action. Suitable for left and right hand use. Resharpenable, straight 1 3/4" narrow blades for tight spaces. Cushioned, non-slip grips.

Item #	Desc	UPC	Vendor	CS/UOS	Location
81380031	1¾"	038313002176	FS 4350	6/6	East

Long Straight Micro Snip (F)

Long, straight, pointed blade for a wide range of applications. Fully heat-treated steel 1 3/4" blade for strength. Blades, spring and handle coated to prevent rust. Unobtrusive leather strap lock.

Item #	Desc	UPC	Vendor	CS/UOS	Location
81380103	Steel	038313049300	AG 4930	12/12	National
81380104	Stainless Steel	038313049317	AG 4930SS	12/12	East

Hydroponic Micro Snip (G)

Compact, sharp stainless steel blades with double beveled tapered tips for precision cuts. Durable handle with soft touch feel for lightweight comfort and performance. Heavy-duty spring for reliable performance. Double-sided lock for left or right hand use. Handle and blades can be sterilized to limit cross contamination. 2 5/16" blade.

Item #	Desc	UPC	Vendor	CS/UOS	Location
81380029	Micro Snip	038313041229	FS 4120	12/12	National

Comfortgel Micro Snip (H)

These gardening scissors feature a 1 3/4" double-beveled blade with tapered tips that easily cut leaves, stems and buds in tight areas, making them ideal trimming scissors for herbs, vegetables and more.

Item #	Desc	UPC	Vendor	CS/UOS	Location
81380605	Micro Snip	038313132149	FS 3214D	6/6	National



Clipper Floral Pruning Shear Snip

Maximize comfort and control with soft, ergonomically shaped grips. Fully heat-treated blades maintain sharpness. Volute spring resists dirt build-up and clogging. Assorted case pack of 12. 3 each, red, green, yellow and black.

Item #	Desc	UPC	Vendor	CS/UOS	Location
81380706	Floral Snip	038313041861	FS43624	12/12	East

Dual Cut Bypass Pruner

Ideal for pruning green or dry stems and branches up to 1-inch in diameter, these pruning shears feature resharpenable MAXFORGED™ steel blades with two cutting zones. One zone gives you the leverage you need for strong, powerful cuts, while the other offers precision for quick, repetitive cuts.

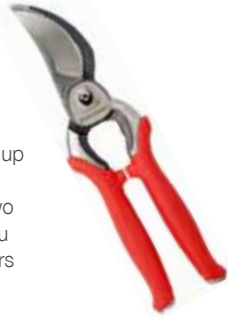

Item #	Desc	UPC	Vendor	CS/UOS	Location
81380155	1" Forged	038313171001	BP 7100D	6/6	West

Hydroponic Scissor

Stainless steel blades with double beveled tapered tips for precision cuts. Durable handle offers lightweight comfort and performance. Handle and blades can be sterilized to limit cross contamination.



Item #	Desc	UPC	Vendor	CS/UOS	Location
81380030	2" blade	038313041335	FS 4130	12/12	National

Precision Scissor

Precision Scissors are compact and precise cutting tools that are perfect for various gardening and crafting tasks. With sharp stainless steel blades, these scissors offer clean and accurate cuts, whether you're pruning small plants, deadheading flowers, or working on intricate crafting projects.



Item #	Desc	UPC	Vendor	CS/UOS	Location
81380683	Precision Scissor	038313145309	FS 14530	6/6	East

Cushioned Grip Polished Aluminum Hand Tools

Lightweight, one-piece, polished aluminum alloy with a cushioned grip. Trowel- Wide 3" blade, Transplanter- Narrow profile ideal for flower pots, Cultivator- 3 Rigid tines penetrate hard ground, Fork- 3 Rigid, straight tines to penetrate ground, Weeder- Ideal for digging or weeding

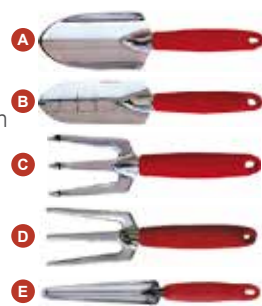

Item #	Desc	UPC	Vendor	CS/UOS	Location
81380014	A Trowel	038313010102	CT 3010i	6/6	National
81380015	B Transplanter	038313010201	CT 3020i	6/6	National
81380016	C Cultivator	038313010300	CT 3030i	6/6	National
81380017	D Fork	038313010409	CT 3040i	6/6	National
81380018	E Weeder	038313210502	CT 3050i	6/6	National

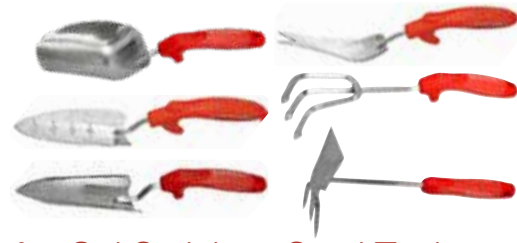

ComfortGel Stainless Steel Tools

Stainless steel heads are durable and will not rust. Ergonomic polygrips minimize hand stress. Safety features include a finger guard and thumb rest, preventing the hand from slipping.

Item #	Desc	UPC	Vendor	CS/UOS	Location
81380524	Scoop	038313336400	CT 3364	8/8	National
81380020	Transplanter	038313322403	CT 3224	8/8	National
81380669	Trowel 7.25"	038313331405	CT 3314	8/8	National
81380523	Weeder	038313335403	CT 3354	8/8	National
81380649	Premium SS Cultivator	038313333409	CT 3334	8/8	National
81380521	Cultivator	038313332402	CT 3324	8/8	National
81380650	Hoe/Cultivator	038313334406	CT 3344	8/8	National

Floral Scissors

Ergonomic grips for superior comfort. Wavy serrated edges to hold stems while cutting, resharpenable stainless steel blades.



Item #	Desc	UPC	Vendor	CS/UOS	Location
81380652	3" blade	038313033941	FS 3394	6/6	National

ClassicCUT Grass Shear

Cuts tough sod and ground cover. Helps you grip the scissors even with sweaty hands and scissors stay comfortable to hold cut after cut. Ideal shear for trimming grass, ground cover, and small hedges.



Item #	Desc	UPC	Vendor	CS/UOS	Location
81380197	4"	038313000059	GS 6750D	6/6	National

Sharpening Tool

5" Super carbide file. Ideal for sharpening all straight blades (excludes saw blades). Easy to fit in pocket or scabbard. Non-slip grip for easy use.



Item #	Desc	UPC	Vendor	CS/UOS	Location
81380003	5"	038313083007	AC 8300	12/12	National



Extendable Handle Hoe (A)

Breaks up clumpy-soil and digs up weeds. Moves and aerates soil.

Item #	Desc	UPC	Vendor	CS/UOS	Location
81380035	18"-32"	038313030605	GT 3060	6/6	National

Extendable Handle Cultivator (B)

Tines cultivate soil during planting process. 5 tine sides to transport, break-up and level soil. Grooved top for fine smoothing of soil.

Item #	Desc	UPC	Vendor	CS/UOS	Location
81380036	18"-32"	038313030704	GT 3070	6/6	National

Extendable Handle Trowel (C)

Strong, lightweight steel handle adjusts from 18" to 32" for extra reach. Head is fully heat-treated for enhanced durability. Long-lasting coating resists chips and rust. Comfortable, soft, textured grip with rugged high-impact thermoplastic ferrule. Convenient hanging ring ensures easy storage.

Item #	Desc	UPC	Vendor	CS/UOS	Location
81380037	18"-32"	038313030803	GT 3080	6/6	National

Extendable Handle Weeder (D)

Item #	Desc	UPC	Vendor	CS/UOS	Location
81380033	18"-32"	038313030407	GT 3040	6/6	East

Extendable Handle Rake (E)

Item #	Desc	UPC	Vendor	CS/UOS	Location
81380034	18"-32"	038313030506	GT 3050	6/6	National

Max Bow Saw

Open frame design allows for increased cut capacity and fewer strokes per cut.



Item #	Desc	UPC	Vendor	CS/UOS	Location
81380672	24"	038313150617	BS15060	6/6	East



Garden Hoe (F)

Swan-shaped neck keeps soil from building up on the tool. 54" Long wood handle allows working in upright position, reduces back strain. Strong socket joint bolstered with a screw. Coated with a clear rust inhibitor.

Item #	Desc	UPC	Vendor	CS/UOS	Location
81380063	6" Blade	038313210007	SH 20000	6/6	National

D-Handle 4-Tine Digging Fork (G)

Tempered steel tines for maximum strength and long service life. 29" Wood D handle grip makes it easier to use in tight spaces. 10" Tapered tines for easier soil penetration.

Item #	Desc	UPC	Vendor	CS/UOS	Location
81380026	29"	038313820008	FK 42000	6/6	National

Dutch Hoe with ComfortGEL Grip (H)

This dutch-style Hoe not only helps aerate soil, but slices easily beneath weeds to stop them in their tracks effectively and safely. The lightweight, 63-inch fiberglass handle features a ComfortGEL Grip, helping maintain hand comfort even after hours of work. Give your garden an old-world treatment, without the old-world soreness.

Item #	Desc	UPC	Vendor	CS/UOS	Location
81386754	63"	038313036645	LG 3664	4/4	East

Compound Action Tree Pruner (D)

High-strength zinc alloy pruning head. Fully heat-treated, high-carbon, PTFE non-stick coated cutlery steel blade with 1 1/4" diameter cutting capacity. Durable rope drive, compound-action pulley system triples your cutting power. Exclusive Powerglide™ rope pull system. Curved 13" Razor Tooth Saw®, 3-Sided razor saw teeth cut twice as fast as conventional blades, saving you time and money. Lightweight fiberglass pole telescopes from 6' to 12' with twist lock adjustment. Comfortable 28" grip.

Item #	Desc	UPC	Vendor	CS/UOS	Location
81380301	6'-12' Dual action	038313068301	TP 6830	4/4	East
81380078	6'-12'	038313538415	TP 3841	4/4	National
81380471	14'	038313042141	TP 4214	4/4	West



Long-Handle Round Point Shovel (A)

Strong, 15-gauge tempered steel blade. Round point allows easy penetration of a variety of materials. Large, forward-turned steps for firmer footing. 48" Long ash wood handle. #2

Item #	Desc	UPC	Vendor	CS/UOS	Location
81380267	48" 15 gauge	038313261009	SS 26000	3/3	National
81380291	48" 14 gauge	038313650001	SS 65000	3/3	National

Long-Handle Square Point Shovel (D)

Strong, 15-gauge tempered steel blade. Square-head design for efficient lifting and moving of loose material. Textured epoxy finish protects head. 48" Long ash wood handle. #2

Item #	Desc	UPC	Vendor	CS/UOS	Location
81380069	48"	038313271008	SS 27000	3/3	National

D-Handle Round Point Shovel (B)

Strong, 15-gauge tempered steel blade. Round point allows easy penetration of a variety of materials. Large, forward-turned steps for firmer footing. 30" Ash wood handle with D grip. #2

Item #	Desc	UPC	Vendor	CS/UOS	Location
81380268	30"	038313260019	SS 26010	6/1	National

D-Handle Garden Spade (E)

Strong, 14-gauge tempered steel blade. Rounded edge penetrates ground easily, slices through small roots. Textured epoxy finish protects 11 3/4" head. 30" Ash wood handle with D grip.

Item #	Desc	UPC	Vendor	CS/UOS	Location
81380278	30"	038313290016	SS 29010	6/1	East

Long-Handle Fiberglass Round Point Shovel (C)

Strong, 15-gauge tempered steel blade. Round point allows easy penetration of a variety of materials. Large, forward-turned steps for firmer footing. 48" Fiberglass handle with cushion grip for comfort. #2

Item #	Desc	UPC	Vendor	CS/UOS	Location
81380269	48"	038313260200	SS 26020	3/3	National
81380072	48" 14 gauge	038313300203	SS 30020	3/3	East

Long-Handle Garden Spade (F)

Strong, 14-gauge tempered steel blade. Rounded edge penetrates ground easily, slices through small roots. Textured epoxy finish protects 11 3/4" head. 48" Long ash wood handle.

Item #	Desc	UPC	Vendor	CS/UOS	Location
81380277	48"	038313290009	SS 29000	6/1	East

Hydroponic Finger Snips

The perfect tool for fine, precision cutting a variety of plants. The compact, stainless steel blades stay razor-sharp, while resisting rust and corrosion. The durable ABS plastic handle is lightweight and comfortable, with a large finger loop that adds control when cutting.



Item #	Desc	UPC	Vendor	CS/UOS	Location
81380194	1.4" blade	038313041113	FS 4110	12/12	East

Edgemaster With Comfortgel Grip

EdgeMASTER Edging Tool delivers quick, clean cuts in grass, sod or soil. Use it to trim sidewalks and create borders for gardens or flower beds. The high-carbon steel ribbed blade is fully heat-treated, durable and self-sharpening. The double-traction grooved footplate supports additional load-bearing pressure. ComfortGEL handles feel great while working.



Item #	Desc	UPC	Vendor	CS/UOS	Location
81380532	Edger	038313368418	LG 3684	4/4	National



ComfortGEL Grip QuickCOLLECTOR (A)

When seed pods and tree nuts fall onto the landscape, they can make quite a mess. Especially when they fall onto mulched or grassy areas where they are tricky to rake or sweep up. QuickCOLLECTOR™ makes clean up easier with less effort.

Item #	Desc	UPC	Vendor	CS/UOS	Location
81380533	48"	038313036942	LG 3694	4/4	National

ComfortGEL Grip Weed Destroyer (B)

Removes tough weeds, without the use of chemicals. All steel footplate, with slip-resistant traction groves, for added control. Fully heat-treated, high carbon steel blades, for extra strength when driving into the soil.

Item #	Desc	UPC	Vendor	CS/UOS	Location
81380531	14.25"	038313365417	LG 3654	4/4	National

ComfortGEL Grip DiscCULTIVATOR (C)

Quick work of maintaining the topsoil around ornamental and crop plants, weeding between rows, aerating soil and prepping bare spots in lawns for reseeding. Its 3 sets of steel tines will do the hard work for you and can be configured to work up close to plants without damaging them or soil structure.

Item #	Desc	UPC	Vendor	CS/UOS	Location
81380530	48"	038313036348	LG 3634	4/4	National

ComfortGEL Grip Soil RIPPER (D)

Used for turning and aerating soil and the development of seed-rows in gardens. A substitute for rototillers in small developed gardens or raised-bed gardens.

Item #	Desc	UPC	Vendor	CS/UOS	Location
81380529	9"x6" steel tines	038313362416	LG 3624	4/4	National

Hori Hori Garden Knife

Flanged at base to protect hand from slipping onto blade. Serrated multi-purpose steel blade for digging, cutting & transplanting.



Item #	Desc	UPC	Vendor	CS/UOS	Location
81386724	8"	038313154097	CT15409	8/8	National



ComfortGEL® Bypass Lopper (E)

ComfortGEL® soft, ergonomically shaped grips for maximum comfort, fit and control. Integrated Shock-Guard® bumpers reduces strain and fatigue. Specially coated, non-stick blades helps maintain maximum sharpness. Enhanced cutting performance with Dual Arc blade design with a 1 1/2" cutting capacity. 30" extra strength, trapezoidal steel handles.

Item #	Desc	UPC	Vendor	CS/UOS	Location
81380064	30"	038313032647	SL 3264	6/6	East

Compound Action Anvil Lopper (F)

Compound Action Anvil Lopper with 1 1/2" cut capacity. 4-Bar compound linkage triples your cutting power. Resharpenable, PTFE non-stick coated high-carbon steel anvil blade. 24" Fiberglass handles. Replaceable blade and anvil. Extra-long 8" non-slip foam grips.

Item #	Desc	UPC	Vendor	CS/UOS	Location
81380027	24"	038313044381	FL 3420	6/1	East

Hedge Shear (G)

Resharpenable, forged 8 1/4" steel alloy blades. Top-grade 9 1/2" hardwood handles. Fully heat-treated for strength. Limb notch for larger branches. Comfortable non-slip grips.

Item #	Desc	UPC	Vendor	CS/UOS	Location
81380199	8 1/4"	038313839116	HS 3911	6/6	National
81380203	9 1/2"	038313000790	HS 6960	6/6	West

Comfortgel Hedge Shear (H)

The ComfortGEL Hedge Shear with 8 in. blades are designed to make quick work of trimming hedges and bushes. The soft, ergonomically shaped grips maximize comfort and control. The Shock GUARD bumpers reduce hand and shoulder fatigue, making gardening activities a joy rather than a chore.

Item #	Desc	UPC	Vendor	CS/UOS	Location
81380039	9"	038313032449	HS 3244	6/6	East

Push. Pull. Lift. Dump.

6 Cube Wheelbarrow



6CF Steel Wheelbarrow with sealed wood handles, and pneumatic tire.

6CF Steel Wheelbarrow with steel handles and comfort grips. Features a flat free tire.

Item #	Desc	Vendor	CS/UOS	Location
81386888	A 6.0 CF, Wood handles, Pneumatic tire	WB13060	1/1	National
81386889	B 6.0 CF, Steel Handles, Flat free tire	WB13163	1/1	National

Kids Wheelbarrow

Kids Poly Wheelbarrow Red Perfect for kids to outdoor yard work.



Item #	Desc	UPC	Vendor	CS/UOS	Location
81380709	Kids Wheelbarrow	038313110024	KD 1002	4/4	National

Poly Wheelbarrow

Corrosion-proof, poly tray with UV protection. Reinforced steel-front tray braces for added support and stability. 15" Wheel assembly with knobby, 4-ply tire for easy maneuvering. Ball bearings for years of smooth performance.



Item #	Desc	UPC	Vendor	CS/UOS	Location
81380079	15" 6cf	038313010065	WB 1006	1/1	West

Kids Garden Tool Set

Kids can work right along side their Parents and experience the thrills of gardening 3pc tools set Shovel, Rake, Hoe in Red.



Item #	Desc	UPC	Vendor	CS/UOS	Location
81380708	3 Piece	038313913014	KD 1001	18/18	National

CT Series Widger

ComfortGEL® tool to easily transplant seedlings and plug plants.



Item #	Desc	UPC	Vendor	CS/UOS	Location
81386723	Widger	038313154080	CT15408	8/8	National

Leather Scabbard

Top-grain leather construction. Stitched and riveted for durability. Belt clip and loops included. Universal design fits most hand pruners.



Item #	Desc	UPC	Vendor	CS/UOS	Location
81380001	5"	038313000813	AC 7220	6/6	National

Nylon Scabbard

Durable Cordura nylon construction. Universal design fits hand pruners and folding saws. Easy to carry using metal clip or belt loops.



Item #	Desc	UPC	Vendor	CS/UOS	Location
81386675	6.75lin L	038313045104	AC 4510	1/1	West

Steel Sledge Hammer

Solid core 15" fiberglass handle. Forged, tempered steel heads break through concrete, asphalt, masonry, drywall or virtually any material. Minimize deflections and finish your work faster with dual ground and polished convex striking faces.



Item #	Desc	UPC	Vendor	CS/UOS	Location
81380298	4lb	038313170028	ST 70020	4/4	West

Sledgehammer

34" Solid Core Fiberglass handle. Forged, tempered steel heads break through concrete, asphalt, masonry, drywall or virtually any material. Minimize deflections and finish your work faster with dual ground and polished convex striking faces.



Item #	Desc	UPC	Vendor	CS/UOS	Location
81386847	12lb	038313701246	ST 70024	4/4	West



Cultivator with Wood Handle (A)

The optimal choice for weeding and cultivating in one stroke, this Corona® 4 Prong Cultivator has a 54" long wooden handle.

Item #	Desc	UPC	Vendor	CS/UOS	Location
81380025	54"	038313200046	CV 20004	6/6	West

Manure Fork (B)

Forged, tempered head for maximum strength and long service life. Medium- to heavy-duty fork for moving manure, compost, planting mix and other dense, damp material.

Item #	Desc	UPC	Vendor	CS/UOS	Location
81380186	5 Tine	038313720056	FK 72005	6/6	West

Max Two Bristle Push Broom (C)

Scraper blade for removing congealed dirt, gum and other residues from concrete walks and pavers. Head is bolted to cast-metal socket, which is pinned to handle, cannot twist loose like threaded handle.

Item #	Desc	UPC	Vendor	CS/UOS	Location
81380139	24" head	038313610029	BM 61002	1/1	West

One Bristle Push Broom (D)

Replaceable hardwood head with medium, feathered poly bristles removes both coarse and fine material in one pass. Head is bolted to cast-metal socket, which is pinned to handle, cannot twist loose like threaded handle.

Item #	Desc	UPC	Vendor	CS/UOS	Location
81380141	24" head	038313620622	BM 62060	1/1	West



Cultivator with Wood Handle

Tempered steel tines for maximum strength and long service life. 29" Wood D handle grip makes it easier to use in tight spaces. 10" Tapered tines for easier soil penetration.

Item #	Desc	UPC	Vendor	CS/UOS	Location
81386790	29"	038313170004	FK 70000	6/6	West



ComfortGEL® Hoe / Cultivator (E)

ComfortGEL® Garden Tools are designed for gardeners working on raised-bed gardens, small gardens and tight access locations. Optimal length for long reach and balance and ideal for gardeners who have physical strength limitations that make large tools hard to manage. The unique, trapezoid shaped handles add comfort and control. ComfortGEL® grips deliver comfort to gardeners who seek an easier, more therapeutic gardening experience.

Item #	Desc	UPC	Vendor	CS/UOS	Location
81380654	36"	038313324414	GT 3244	4/4	West

YardBREATHER w/ ComfortGEL Grip (F)

The Corona YardBREATHER™ allows you to easily break up grass and compact soil to allow air, water and nutrients to reach the roots to promote growth. Designed to automatically eject 3.5inch long soil plugs with each step. The slip resistant, traction grooves on the footplate add safety and stability while the heat treated steel footplate and spikes gives lasting durability. With ComfortGEL grips deliver comfort and control when working the garden and yard.

Item #	Desc	UPC	Vendor	CS/UOS	Location
81380528	50"	038313360412	LG 3604	4/4	West

RootIRRIGATOR w/ ComfortGEL Grip (G)

Root Irrigator with shut-off valve provides water or fertilizer directly to tree roots · Eliminates water runoff and evaporation. Detachable, 3" inch brass valve makes it easy to control water flow. Repair your lawn, edge a border or prepare a garden bed with comfort and innovative features.

Item #	Desc	UPC	Vendor	CS/UOS	Location
81380534	36.5"	038313371012	LG 3710	4/4	West

Operating Wrench (H)

Multifunctional, opens valves with 3 interchangeable heads - 1, 1/8 and 2 inches. Square key operates gate valves with a 2 inch square operating nut. Conveniently store heads on tool with snap button lock. Extends from 3 to 5 feet by releasing a snap button. Solid steel construction with "T" style handle design for better leverage. Red color so it's easier to find on the job.

Item #	Desc	UPC	Vendor	CS/UOS	Location
81386869	3-in-1	038313699994	UT 69000	2/2	West



Light-Duty Bow Head Rake (A)

Tempered, single-piece head for greater durability and long service life. Curved tines efficiently gather and move soil. Bow serves as spring for better control of tine depth.

Item #	Desc	UPC	Vendor	CS/UOS	Location
81380044	14" head	038313810009	RK 10000	6/6	West

Thatch & Groom Rake (B)

Industry standard thatching rake works on push and pull motions. Unique, adjustable rake head adjusts up and down to suit the height of the user. Quickly and easily rid heavy layers of thatch and dead grass from any lawn.

Item #	Desc	UPC	Vendor	CS/UOS	Location
81380053	15" head	038313520007	RK 42000	6/6	West

Fixed Tine Shrub Rake w/ Wood Handle (C)

This shrub rake has tempered spring steel for greater durability and long service life, with a bi-curved bow that gives even pressure to 11 tines for maximum raking efficiency. Narrow head allows for raking between bushes and closely spaced plants.

Item #	Desc	UPC	Vendor	CS/UOS	Location
81380236	11" head	038313562007	RK 62000	12/12	West

Fixed Tine Shrub Rake (D)

This Corona Fixed Tine Rake is ideal for raking in tight spaces such as around shrubs and other plantings

Item #	Desc	UPC	Vendor	CS/UOS	Location
81380056	11" head	038313620608	RK 62060	12/12	West

Curved Trenching Shovel

The trenching shovel is a great tool designed for digging and clearing trenches. Great tool for homeowners and contractors. This tool is indispensable for laying irrigation pipes, digging a compost trench, or removing deeply rooted plants. The rounded tip and squared sides produce clean trench walls and minimize disruption of the surrounding soil.

Item #	Desc	UPC	Vendor	CS/UOS	Location
81386827	4"	038313006419	SS 64124	6/6	West
81386828	5"	038313641252	SS 64125	6/6	West

Fixed Tine Leaf Rake (E)

Fixed tine shrub and leaf rake with 25 extra-wide tines; applies light pressure without damaging plant feeder roots. Bi-curved bow design gives even pressure to all tines for maximum raking efficiency. Rake head made from tempered spring steel for greater durability.

Item #	Desc	UPC	Vendor	CS/UOS	Location
81380057	19" wide	038313620615	RK 62061	12/12	West

Level Head Rake (F)

14 inch level-head design for efficient, accurate tilling and leveling landscape materials, small head is ideal for working in close quarters. Extra-thick, tempered steel tines for greater strength and long service life. Flat head with straight tines for smooth tamping of seed beds.

Item #	Desc	UPC	Vendor	CS/UOS	Location
81380238	14" head	038313700027	RK 64002	3/3	West



Closed-Back Drain Spade

Closed-back design protects handle from mud and dirt build up. Baked finish protects against rust. Double rivets give greater strength. Tempered, round-nose, slightly cupped, 16" blade for efficient digging of deep, round-bottom drains and trenches.

Item #	Desc	UPC	Vendor	CS/UOS	Location
81386817	16"	038313620103	SS 62010	6/6	West



Trench Shovel

Efficient Digging 28 Degree Design Engineered To Penetrate & Loosen Compacted Soil. Heavy duty 12 gauge V-Shaped Beveled Blade. Sole Saver Step with rounded corners reduces boot wear.

Item #	Desc	UPC	Vendor	CS/UOS	Location
81386830	3" - Blue	038313643034	SS 64303	6/6	West
81386831	4" - Orange	038313543044	SS 64304	6/6	West



Compound Action Hedge Shears (A)

Compound Action Aluminum Handle Hedge Shear 8 1/2" high-carbon steel blades are fully heat treated Compound action multiplies your cutting power Top blade is serrated and features a limb cutting notch. Bottom blade is Teflon(tm) coated for easy clean cutting. Lightweight, strong aluminum handles with ergonomic grip.

Item #	Desc	UPC	Vendor	CS/UOS	Location
81380108	9"	038313042202	AH 4220	6/6	West

Extendable Hedge Shears (B)

Extendable handle hedge shears with ComfortGEL grips for superior comfort and less hand fatigue.

Item #	Desc	UPC	Vendor	CS/UOS	Location
81380656	9"	038313033446	HS 3344	6/6	West

Bypass Lopper (C)

Corona's 26-inch bypass lopper has tapered hickory handles and blister-detering nonslip grips. Its resharpenable, dropforged, Radial Arc bypass, Coronium steel alloy blade has a 1-1/2-inch-diameter cutting capacity. The lopper also boasts a precision slant-ground hook with sap groove for consistently smooth cutting.

Item #	Desc	UPC	Vendor	CS/UOS	Location
81380319	26"	038313005269	WL 3351	6/6	West

Super-Duty Bypass Lopper (D)

Corona SL 6500 Super Duty Bypass 32 inch Lopper has a 3" cut capacity to power through large branches. Comprised of forged blades at a cutting angle designed to cut 3" branches and robust steel handles to handle extreme leverage, the SL 6500 can expeditiously cut through thick branches.

Item #	Desc	UPC	Vendor	CS/UOS	Location
81380262	32"	038313665005	SL 6500	6/6	West

Easy Cut Bypass Lopper (E)

EasyCUT COMPOUND ACTION magnifies your cutting power so you can do more with less effort.

Item #	Desc	UPC	Vendor	CS/UOS	Location
81380190	32"	038313044367	FL 3460	6/6	West

ComfortGEL Extendable Bypass Loppers (F)

Reach new heights (and lengths) with Corona Tools strength with the Dual LINK Extendable Bypass Lopper with Comfort GEL grip. Dual LINK power-compounding technology makes tree pruning effortless for gardeners and landscapers alike.

Item #	Desc	UPC	Vendor	CS/UOS	Location
81380660	27.5"-37.5"	038313033644	SL 3364	6/6	West

Dual Cut Bypass Lopper (G)

Take care of your garden with this Corona DualCUT bypass lopper. The special hook design allows sharp branch cutting. Max forged steel construction ensures long-lasting sharpness. Made for most hand sizes, it offers comfortable, contoured handle grips and a shock-absorbing bumper.

Item #	Desc	UPC	Vendor	CS/UOS	Location
81380066	31"	038313071806	SL 7180	6/6	West

Forged Aluminum Handle Hedge Shear

This shear is designed to help you rapidly cover large areas, since its long tapered blade, end curvature and bevel angles are optimized for high volume cutting as well as detail cutting.

Item #	Desc	UPC	Vendor	CS/UOS	Location
81380112	10 1/2" Blade	038313069704	AH 6970	6/6	West





Landscape Irrigation Bypass Pruner (A)

Cut branches, stems and green wood up to 1-inch in diameter. The contoured handle with non-slip grips and the vertical angled blade reduce effort and hand fatigue when gardening. Plus, their blade tip is specifically designed for adjusting sprinklers, maximizing the convenience of this hand tool.

Item #	Desc	UPC	Vendor	CS/UOS	Location
81380146	1"	038313136703	BP 3670	6/6	West

Ergonomic Bypass Pruner (B)

Ergonomic Bypass Pruner is the perfect gardening hand tool for taking on your everyday gardening and landscaping work. These lightweight pruning shears feature an angled bypass blade for cutting low-lying green or dry branches and stems up to 3/4-inch thick.

Item #	Desc	UPC	Vendor	CS/UOS	Location
81380147	2.5"	038313041809	BP 4180	6/6	West

Flexdial Bypass Pruner (C)

Cut green or dry branches and stems up to 3/4-inches in diameter with the Corona FlexDIAL Bypass Pruner. This flexible bypass pruner features an adjustable 8-position dial that is designed to easily adapt to your hand size and the way you landscape or garden.

Item #	Desc	UPC	Vendor	CS/UOS	Location
81380573	2.75"	038313142148	BP 4214D	4/4	West

Forged Bypass Pruner Rolling Handle (D)

The ergonomic "rolling" handle design of this pruner helps to reduce both cutting effort and user fatigue. A geared pivot bolt allows for precise blade adjustments. The volute spring resists clogging and maintains smooth cutting action. High-carbon steel blade. Lightweight forged aluminum handles.

Item #	Desc	UPC	Vendor	CS/UOS	Location
81380148	1"	038313048402	BP 4840	6/6	West

Ratchet Cut Pruner (E)

Specially designed to reduce effort and hand fatigue when cutting larger branches, these garden shears feature an innovative four-gear mechanism that increases cutting power with each click, allowing you to adjust for more leverage mid-cut up to 3/4".

Item #	Desc	UPC	Vendor	CS/UOS	Location
81380575	3"	038313142247	RP 4224D	4/4	West

Two-Handed Pruner

Corona's forging process compacts steel molecules into our strongest, most durable tools that stay sharper longer. Two-handed pruner is ideal for landscaping pros and avid gardeners



Item #	Desc	UPC	Vendor	CS/UOS	Location
81380144	3/4"	038313632250	BP 3225D	6/6	West

Bypass Lopper with Aluminum handles

The Bypass Lopper has a 1.5 " diameter cutting capacity with lightweight, high-strength 29" aluminum handles. The high quality forged carbon steel bypass blade is resharpenable.



Item #	Desc	UPC	Vendor	CS/UOS	Location
81380259	29"	038313041502	SL 4150	6/6	West

Forged Aluminum Bypass Pruner

1 inch cut capacity, all-aluminum handles and hook. Straight, non-angled head. Replaceable blade and spring are interchangeable with Felco® 2.



Item #	Desc	UPC	Vendor	CS/UOS	Location
81380012	1" forged	038313008307	BP 6250	6/6	West

Pipe Cutter

High carbon steel blade for maximum performance. Flip-up Tab on Bolt - No Tools Needed to Change the Blade Quickly; Crosshatch Grip on Blade for Easy Replacement; Left or right hand to cut Schedule 40 pipe with ease using ratchet action.



Item #	Desc	UPC	Vendor	CS/UOS	Location
81380438	1" PVC	038313165505	UT 65050	6/6	West

Ratchet Pruner

Power multiplying ratchet action. 3/4 inch cut capacity. Non-stick coated steel blade. Co-molded handles.



Item #	Desc	UPC	Vendor	CS/UOS	Location
81380059	3/4"	038313032302	RP 3230	6/6	West



All-Steel Round Point Shovel (A)

Round point 12 gauge steel, 15" blade for heavy-duty digging, lifting, and moving of soil, sand, or other materials. Designed for durability and strength in tough outdoor conditions. Suitable for various gardening, landscaping, and construction tasks.

Item #	Desc	UPC	Vendor	CS/UOS	Location
81380130	48"	038313903008	AS 90300	2/2	West

Aluminum Scoop Shovel #10 Western (F)

30" Steel and Northern Ash wood, D grip helps turn loosened soil, easier to use in close quarters. High-strength, heavy, 12-gauge aluminum head reduces work load to a minimum while giving longer service life.

Item #	Desc	UPC	Vendor	CS/UOS	Location
81380296	30"	038313680107	SS 68010	4/4	West

Round Point Shovel w/ Fiberglass Handle (B)

Extra-thick, 14-gauge tempered steel blade for maximum toughness. Extended widow's peak socket adds strength for a secure connection. Baked finish protects against rust. Pre-sharpened blade edge penetrates ground easily. 12" blade.

Item #	Desc	UPC	Vendor	CS/UOS	Location
81380293	48"	038313650209	SS 65020	6/6	West

Plastic Western Scoop Shovel #12 (G)

The Western Scoop Shovel is perfect for efficiently turning and moving loosened soil. The reinforced ribs on the scoop head make it suitable for heavy-duty applications while the 30 in. handle allows for easier maneuvering in close quarters. Built for extended use, the shovel features a lightweight construction with a plastic head and wood handle. The D-grip also helps control movement while transferring material, ensuring comfortable and precise use. A lifetime warranty guarantees this product is free of material and workmanship defects for the life of the tool.

Item #	Desc	UPC	Vendor	CS/UOS	Location
81380282	30"	038313420031	SS 42011	6/6	West

Light-Duty Floral Shovel (C)

Small head design for easier use in gardens and tight spaces. 6 inch x 8 inch steel, 12" blade.

Item #	Desc	UPC	Vendor	CS/UOS	Location
81380283	42"	038313970000	SS 47000	6/6	West

Square Point Shovel Wooden Handle (D)

Square-head design for efficient lifting and moving of loose material. Large, forward-turned steps prevent material from spilling off rear of blade. Extra-thick, 14-gauge tempered steel 11" blade for maximum toughness.

Item #	Desc	UPC	Vendor	CS/UOS	Location
81380294	48"	038313660000	SS 66000	3/3	West

Square Point Shovel Fiberglass Handle (E)

Square-head design for efficient lifting and moving of loose material. Large, forward-turned steps prevent material from spilling off rear of blade. Extra-thick, 15-gauge tempered steel 12" blade for maximum toughness.

Item #	Desc	UPC	Vendor	CS/UOS	Location
81380271	48"	038313270209	SS 27020	3/6	West



Multi-Purpose Mini Shovel

The Multi-Purpose Mini Shovel is a versatile tool designed for tight working conditions or digging while on your knees. With a strong 16-Gauge tempered steel blade and forward-turned steps for firmer footing, it ensures efficient use. The hardwood D-grip handle helps control the material being moved, making it a practical and convenient tool for various tasks. With an overall length of 26¾ inches and a durable construction, this shovel is a valuable addition to your gardening equipment.

Item #	Desc	UPC	Vendor	CS/UOS	Location
81380266	26"	038313825010	SS 25010	6/6	West



Extendable Fruit Picker

Hook the fruit between the prongs and gently pull to pick. 5 in. D basket is powder-coated to resist rust and corrosion. Foam cushion in basket reduces fruit bruising. Aluminum pole extends to 12 ft.

Item #	Desc	UPC	Vendor	CS/UOS	Location
81380028	12ft	038313723125	FP 2312	6/6	West



ErgoHandle Machete

Durable blade, tough tempered Steel for greater strength retains max sharpness. Easy to re-sharpen, carbon Steel blade. Ergonomically comfortable handle balanced with blade length.

Item #	Desc	UPC	Vendor	CS/UOS	Location
81380595	18"	038313699611	MA 60061	6/6	West
81380657	22"	038313600129	MA 60062	6/6	West

Folding Curved Blade Pruning Saw

The 10-1/2" Folding Pruning Saw is designed to be as comfortable in your hand as it is effective in the field. This self-cleaning raker tooth model resists binding on green or woody limbs. Designed for small to medium branches, the 10-1/2-inch blade folds into the handle for safety, storage, and easy transport.



Item #	Desc	UPC	Vendor	CS/UOS	Location
81380228	10"	038313000417	PS 4050	6/6	West



Pulaski Fire Axe

Solid-core 34 inch fiberglass handle with thick, molded poly jacket for maximum strength and long service life. Dampens vibration from overstrikes to prevent breakage. Extra-sharp axe blade with steep bevel angle to hold edge while cutting roots in soil.

Item #	Desc	UPC	Vendor	CS/UOS	Location
81380137	3lb head	038313071028	AX 71020	4/4	West



Forged Digging Bar

Drop-forged and heat-treated for excellent strength during prying, digging and tamping. Hexagon steel construction for enhanced strength. 1" blade width.

Item #	Desc	UPC	Vendor	CS/UOS	Location
81380158	17lb 70"	038313710903	BR 71090	1/1	West



San Angelo Bar

Drop-forged and heat-treated for excellent strength during prying, digging and tamping. Hexagon steel construction for enhanced strength. 2" blade width.

Item #	Desc	UPC	Vendor	CS/UOS	Location
81380013	14lb 60"	038313700904	BR 70090	1/1	West



Extendable Handle 3-Tine Hoe

The Extendable Handle tools have a strong, lightweight steel handle that adjusts from 18" to 32" for extra reach. The head is fully heat treated for enhanced durability with a long-lasting coating that resists chips and rust. The handle has a comfortable, soft textured grip with rugged, high impact thermoplastic ferrule and a convenient hanging ring to ensure easy storage.

Item #	Desc	UPC	Vendor	CS/UOS	Location
81380038	18" - 32"	038313030902	GT 3090	6/6	West



Long Reach Pruner

Ideal for pruning high or low, without bending or straining. Head rotates, tilts, and swivels for unlimited cutting positions. Oval end-grip with rubber overmold increases reach.

Item #	Desc	UPC	Vendor	CS/UOS	Location
81380299	1.25" in cut	038313032067	TP 3206	4/4	West



Long Reach Cut 'n' Hold Pruner

Light duty extendable pruner designed to cut small twigs and collect them inside hard to reach areas. Cuts up to 1/2 inch diameter. Assists in preventing falling limbs and allows you to cut safely.

Item #	Desc	UPC	Vendor	CS/UOS	Location
81380205	46"	038313634605	LR 3460	6/6	West



Post Hole Digger (A)

Heavy-duty, Atlas Pattern 14-gauge tempered steel heads for greater strength and long service life. Pre sharpened-blade edge for easy ground penetration, slices through small roots. 48" Extra-thick ash handles for durability, longer service life and more elevated grip.

Item #	Desc	UPC	Vendor	CS/UOS	Location
81380042	48"	038313200015	PD 20000	2/2	West

Oscillating Hoe (B)

Heavy-duty construction blade design for long service life. Hoe automatically angles slightly downward on both forward and back stroke to slice weeds just below surface. 60 inch wood handle.

Item #	Desc	UPC	Vendor	CS/UOS	Location
81380256	5"	038313160012	SH 60001	6/6	West

Diamond Hoe (C)

Diamond shape head with four sharpened edges cuts weeds on both forward and back strokes. Points of diamond shaped blade can nick even small weeds from hard to reach areas. 60 inch wood handle.

Item #	Desc	UPC	Vendor	CS/UOS	Location
81380257	8"	038313061005	SH 61000	6/6	West

McLeod Hoe (D)

Tempered tines for maximum strength and long service life. The 48"L American Ash wood handle enables upright stance, reducing back strain. Hoe edge is 9" wide with six 3-3/5-inch long rake teeth. Ships unassembled.

Item #	Desc	UPC	Vendor	CS/UOS	Location
81386810	48" long	038313065003	SH 65000	6/6	West



Dirt Tamp (E)

Heavy-duty, all-steel cast construction for long service life. 10" Square face and 60" long shaft for efficient tamping of trenches, specimen tree holes and base materials

Item #	Desc	UPC	Vendor	CS/UOS	Location
81386854	10" X 10"	038313600532	UT 60053	1/1	West

Oscillating Hoe (F)

The Oscillating Hoe, 6 in., is designed for efficient and comfortable gardening. With a heavy-duty construction blade for a long service life, the hoe automatically angles slightly downward on both the forward and back stroke, slicing weeds just below the surface. The concave 6" blade sharpens during use, and the 60" long aluminum handle allows working in an upright position, reducing back strain.

Item #	Desc	UPC	Vendor	CS/UOS	Location
81386809	6" Blade	038313600617	SH 60061	6/6	West

Cultivator 4 Prong Aluminum Handle (G)

The 4 Prong Cultivator makes gardening tasks easy. The product is built with a sharp and sturdy 4 prong design for hassle-free use. This tool effortlessly breaks through even the toughest soil. The lightweight aluminum handle helps in easy maneuvering.

Item #	Desc	UPC	Vendor	CS/UOS	Location
81380177	60"	038313600648	CV 60064	6/6	West

Atlas Pattern Post Hole Digger (H)

The Atlas Pattern Post Hole Digger made with 12-gauge steel and fiberglass handles, making it perfect for digging holes to plant tree saplings or setting sign and fence posts. Its 12-gauge tempered steel head is pre-sharpened to easily penetrate the ground, slicing through small roots, and its 48 in. fiberglass handles strike a good balance between weight and durability. Plus, it features ruler markings for quickly identifying correct hole depth. A lifetime warranty guarantees this product is free of material and workmanship defects for the life of the tool.

Item #	Desc	UPC	Vendor	CS/UOS	Location
81386796	48"	038313400217	PD 40020	2/2	West



Planting Mattock

All-steel construction for rugged use and long life. High-quality, welded construction for superior strength. Rubber grip on handle for comfortable anti-slip grip. All-steel 14 gauge. 2" & 1.3" wide head.



Item #	Desc	UPC	Vendor	CS/UOS	Location
81386794	2" wide blade	038313692001	HT 69200	6/6	West

Pick Mattock w/ Wood Handle

Forged, tempered steel head hardened for maximum strength, toughness, superior wear, impact resistance, safety and long service life. Extra-wide mattock blade for more efficient breaking of dense heavy soils. Point for fracturing, prying rock. Head connected through eye hole allowing easy replacement of head.



Item #	Desc	UPC	Vendor	CS/UOS	Location
81380220	5lb 36"	038313411008	PM 41000	4/4	West

Cutter Mattock w/ Wood Handle

Extra-wide mattock blade for more efficient breaking of dense heavy soils. Extra-sharp cutter blade for severing roots. Head connected through eye hole allowing easy replacement of head.



Item #	Desc	UPC	Vendor	CS/UOS	Location
81380221	5lb 36"	038313420000	PM 42000	4/4	West



Kids Tool Display

1 Display box, 15 shovels, 15 rakes, and 6 hoes. Carbon steel head with powder coated. 70CM Light weight steel handle.

Item #	Desc	UPC	Vendor	CS/UOS	Location
82730161	Kids Tool Display	662652731420	5861D	1/1	National

Floral Snip

Stainless steel blade with mirror polish. Perfect for pruning and thinning. Non-slip comfortable grip.



Item #	Desc	UPC	Vendor	CS/UOS	Location
82730115	6.5" Floral Snip	760249613712	1154BG	6/6	National

Floral Shears

Comfort thermoplastic rubber grips. Zinc alloy handles. Heat-treated blade stays sharp longer.



Item #	Desc	UPC	Vendor	CS/UOS	Location
82730114	6" Floral Shears	760249613729	1153BG	6/6	National

Bypass Pruner

Die cast aluminum construction. Adjustable tension safety lock. Carbon steel blade with Non-slip grips.



Item #	Desc	UPC	Vendor	CS/UOS	Location
82730116	8" - Red	662652731123	1181	6/6	National
82730117	8" - Blue & Green	760249613668	1181BG	6/6	National

Folding Pruning Saw

Precision sharpened teeth. Heat-treated blade stays sharp longer. Blade folds easily into handle for safe storage.



Item #	Desc	UPC	Vendor	CS/UOS	Location
82730008	8"	760249613811	1504	6/6	National

Household Shears

Rust resistant stainless steel blades. Great for the garden and kitchen. Multi-purpose use.



Item #	Desc	UPC	Vendor	CS/UOS	Location
82730126	Shears	760249613743	1931BG	12/12	National



Pro Bypass Pruner

Cuts with a clean scissor-like action. Heat-treated carbon steel blade stays sharper longer. Non-slip grips.



Item #	Desc	UPC	Vendor	CS/UOS	Location
82730001	8"	760249613675	1130	6/6	National

Ergonomic Bypass Pruner

Cuts with a clean scissor-like action. Heat-treated blade stays sharper longer.



Item #	Desc	UPC	Vendor	CS/UOS	Location
82730002	7.5"	760249613699	1140	6/6	National

Ergo Anvil Pruner

Cuts with a clean scissor-like action. Heat-treated blade stays sharper longer.



Item #	Desc	UPC	Vendor	CS/UOS	Location
82730003	7.5"	760249613705	1141	6/6	National

Drop Forged Pruner

Precision ground blade with Non-slip grips.



Item #	Desc	UPC	Vendor	CS/UOS	Location
82730004	8"	662652731130	1183	6/6	National

Drop Forged Pruning Set

3108 Drop Forged Pruner Set has 3/4 inch cutting capacity. Heavy duty spring. Easily taken apart for sharpening and cleaning. Contoured handles with comfortable non-slip grips. Make your plants more beautiful in less time while not hurting your hand over long projects with this pruning set.



Item #	Desc	UPC	Vendor	CS/UOS	Location
82730016	Set	760249613910	1808	12/12	National



Stainless Steel Tools

Stainless steel with mirror polish. Comfortable soft non-slip grip.

Item #	Desc	UPC	Vendor	CS/UOS	Location
82730037	Trowel	662652731345	2201	12/12	National
82730038	Transplanter	662652731352	2202	12/12	National
82730039	Cultivator	662652731369	2203	12/12	National
82730040	Culti-Hoe	662652731376	2204	12/12	National
82730041	Weeder	760249614177	2205	12/12	National



Poly Tools

Durable poly construction. Easy handling and ultra-durable.

Item #	Desc	UPC	Vendor	CS/UOS	Location
82730042	Trowel	760249614184	2401	12/12	National
82730043	Transplanter	760249614191	2402	12/12	National
82730044	Cultivator	760249614207	2403	12/12	National
82730045	Scoop	760249614214	2404	12/12	National



Easy Grip Tools

Powder coated finish head. Ergonomic rubberized grip.

Item #	Desc	UPC	Vendor	CS/UOS	Location
82730032	Trowel	760249614085	2171	12/12	National
82730033	Transplanter	760249614092	2172	12/12	National
82730034	Cultivator	760249614108	2173	12/12	National
82730035	Culti-Hoe	760249614115	2174	12/12	National
82730036	Fan Rake	760249614122	2175	12/12	National



D-Handle Mini Shovel

Tempered heat-treated steel head for greater strength and longer life. Forward turned steps for secure footing on shovels.

Item #	Desc	UPC	Vendor	CS/UOS	Location
82730059	Fiberglass	662652731253	3215	12/12	National



Wooden Handle Tools

Rust resistant powder coated paint. Comfortable foam cushion grip. All come in blue and green.

Item #	Desc	UPC	Vendor	CS/UOS	Location
82730127	Weeder	760249614023	2150BG	12/12	National
82730128	Cultivator	760249614016	2151BG	12/12	National
82730129	Transplanter	760249614009	2152BG	12/12	National
82730130	Trowel	760249613996	2153BG	12/12	National

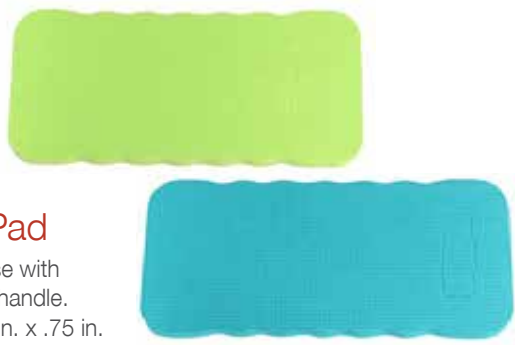

Kneeling Pad

Multi-purpose use with punch out carry handle. 16.25 in. x 7.25 in. x .75 in.

Item #	Desc	UPC	Vendor	CS/UOS	Location
82730154	Kneeling Pad	760249614931	6380BG	12/12	National



Bulb Planter

Powder coated steel body. Hammertone finish. Hardwood handle.

Item #	Desc	UPC	Vendor	CS/UOS	Location
82730027	Bulb Planter	760249614283	2109	12/12	National



Bypass Pruner Carded

The Bypass Pruner with stainless steel blades is designed for garden and yard trimming. With non-slip rubber grips molded over a cast aluminum frame, the Bypass Pruner offers both strength and comfort. The Bypass Pruner has a 5/8-Inch cutting capacity and a locking mechanism for safe storage. Case pack features six assorted colors

Item #	Desc	UPC	Vendor	CS/UOS	Location
80170068	Pruner	10036434180404	10-18140	12/12	National



Compact Shears

The Compact Shear is ideal for cutting flowers, or multiple household uses. The lightweight shear is made with corrosion resistant stainless steel blades for precise trimming and shaping, and is great for Bonsai. The ergonomic handle fits your hand for a comfortable cut every time. The Compact Shear has a blade lock mechanism for safe storage. Case includes 2 each pruners of 6 vivid colors

Item #	Desc	UPC	Vendor	CS/UOS	Location
80170062	Shear	036434180209	10-18020	12/12	National



Compact Pruners

The Compact Pruner is the perfect tool for trimming woody stems and perennials. The lightweight pruner is made with corrosion resistant stainless steel blades and 1/4-Inch cutting capacity. The ergonomic handle fits your hand for a comfortable cut every time. The ColorPoint Compact Pruner has a blade lock mechanism for safe storage.

Item #	Desc	UPC	Vendor	CS/UOS	Location
80170061	Pruner	036434180107	10-18010	12/12	National

DRAMM



Compact Display Boxes

Item #	Desc	UPC	Vendor	CS/UOS	Location
80170473	Berry Shears	036434180261	6019010	6/6	West
80170472	Blue Shears	036434180254	6018026	6/6	West
80170471	Green Shears	036434180247	6018025	6/6	West
80170470	Yellow Shears	036434180230	6018024	6/6	West
80170469	Orange Shears	036434180223	6018023	6/6	West
80170468	Red Shears	036434180216	6018022	6/6	West
80170063 A	Shears Asst.	036434280203	10-28020	12/12	National
80170467	Berry Pruners	036434180162	6018021	6/6	West
80170466	Blue Pruners	036434180155	6018016	6/6	West
80170465	Green Pruners	036434180148	6018015	6/6	West
80170464	Yellow Pruners	036434180131	6018014	6/6	West
80170463	Orange Pruners	036434180124	6018013	6/6	West
80170462	Red Pruners	036434180117	6018012	6/6	West
80170064 B	Pruners Asst.	036434280104	10-28010	12/12	National
80170065 C	Shear/Pruner combo Asst.	036434280197	10-28019	12/12	National
80170251 D	Bypass Pro Asst.	10036434280906	1028090	12/12	National



Poly Tarp

These are UV resistant and have heat sealed seams. Aluminum rustproof grommets about every 3' around the hem. 3/16" boltroping in hem. 5-6 mil thickness. 2.3 oz.



Item #	Desc	UPC	Vendor	CS/UOS	Location
80010106	6'x 8'	043326157102	M6X8	30/30	National
80010107	8'x 10'	043326157201	M8X10	20/20	National
80010108	10'x 12'	043326157324	M10X12	15/15	National
80010110	12'x 16'	043326157454	M12X16	8/8	National
80010117	20'x 20'	043326157614	M20X20	4/4	National



F-600 Folding Miracle Saw

Fast, easy pull action is easier and safer than other saws. The shape of the turbo-cut blade is thinner at the top and thicker at the bottom-where the teeth are. This unique Felco feature keeps only the teeth in contact with the material to be cut. This prevents clogging and binding, since the sides of the blade never come in contact with the wood.

Item #	Desc	UPC	Vendor	CS/UOS	Location
80260012	Saw	783929100265	11600	40/1	National

Victorinox Knife Pointed Blade

The Felco and Victorinox folding all purpose budding knife with a durable 2 1/4" stainless steel blade and bark lifter and alloyed lined red nylon handle. Ideal for nurseries and gardeners to encourage bud production. This Swiss made horticultural budding knife is a must for any garden.



Item #	Desc	UPC	Vendor	CS/UOS	Location
83-1440	Knife	7611160003140	61882R	1/1	National



Replacement Cutting Blades for Pruners

Packaged in an attractive blister pack. Includes rivets.



Item #	Desc	UPC	Vendor	CS/UOS	Location
80260001	#2-3	783929400013	1223	50/1	National

Replacement Spring Kit

Are your pruners listless and unresponsive? Do they open slowly or not at all? Put the spring back in your pruners. Pruner springs should be replaced every year for best performance. Made in Switzerland. Contains two springs (2-11).



Item #	Desc	UPC	Vendor	CS/UOS	Location
80260002	2 Pack	783929400181	12291	25/1	National



F-2 Hand Pruner (A)

Comfortable, light, sturdy handles made of forged aluminium with a lifetime guarantee. Blade and riveted anvil blade made of high quality hardened steel. Clean, precise cut. All parts can be replaced.

Item #	Desc	UPC	Vendor	CS/UOS	Location
80260008	Pruner	783929100012	112	50/1	National

F-5 Economy Pruner (B)

The Felco 5 bypass pruner, with handles made from solid steel and simplified construction, is an ideal choice for the home hobby gardener. No cushion stop, sap groove or wire-cutting notch.

Item #	Desc	UPC	Vendor	CS/UOS	Location
80260010	Pruner	783929100036	115	50/1	National

F-8 Pruner (C)

Both cutting and anvil blades are not riveted and the narrow, pointed blade design allows for close pruning. Light alloy handles are shaped to act as an extension of the forearm. The anvil blade handle is designed to prevent the pruner from sliding through the hand. This hollow ground, Swiss, precision, hardened steel blade features a wire-cutting notch. The blades are set on dowel pins for easy maintenance.

Item #	Desc	UPC	Vendor	CS/UOS	Location
80260014	Pruner	783929100067	118	50/1	National

Heavy-Duty Flat Belt/Clip Pruner Holster

For belt or pocket, high-tension metal clip on back. Holds any Felco pruner, Felco one-hand wire cutters, the F-CP cutter or the F600 pruning saw.



Item #	Desc	UPC	Vendor	CS/UOS	Location
80260016	9.3"	783929400679	13910	1/1	National

Cone-Shaped Belt/Clip Pruner Holster

Heavy-duty grain leather with, waxed thread and extra riveting for long lasting use. This holster was specially designed to fit all Felco pruners and one-hand wire cutters. Can be used on belt or pocket with clip.



Item #	Desc	UPC	Vendor	CS/UOS	Location
80260017	5.9"	783929400686	13912	1/1	National



Jumbo Bedding Plant Tray

Will hold 2 to 8 bedding plant six-packs for easy handling. Sold by the bundle - 32 cases per pallet. 18 1/4" X 12" X 2"

Item #	Desc	UPC	Vendor	CS/UOS	Location
82280095	Jumbo 50 per case	732221110168	11016	12/12	National



Roto Driller

Let these garden augers do the digging work for you. Just attach to any cordless drill 3/8 inch or larger; they dig holes with the ease of a power tool. These garden augers are unsurpassed for planting bulbs, bedding plants and seedlings, installing plc. Sprinkler lines under sidewalks, deep watering, aerating and fertilizing trees and shrubs, and weeding. Save time and energy with yard butler's garden augers. Solid steel construction for durability and reliability.



Item #	Desc	UPC	Vendor	CS/UOS	Location
80740077	9" x 1.75"	033607007011	RT-1	6/6	National
80740076	30" x 1.75"	033607007028	RD-2	6/6	National

2025

Rocket Weeder

The Rocket Weeder's unique gripping action pulls out even the most stubborn weeds, root and all, without damaging the surrounding turf or ground cover. The forks grab the weed without breaking off the roots and the ergonomic handle does most of the work by pulling the weed and roots up out of the ground. The ejector button drops the weed where you want it, keeping your hands clean. Weeding has never been easier or more satisfying.



Item #	Desc	UPC	Vendor	CS/UOS	Location
80740009	37"	033607510009	RKT-1000	4/4	National

Garden Kneeler & Seat

Helps stop back pain and sore knees while gardening. Kneel in cushioned comfort or turn over to sit at proper height for gardening and a multitude of other household chores. Both sides of the frame have 3/4in thick foam for comfort. In the kneeler position, the extended arms make getting up and down easier. Folds for easy storage.



Item #	Desc	UPC	Vendor	CS/UOS	Location
80740005	24" L x 11" W	033607521005	GKS-2	4/4	National

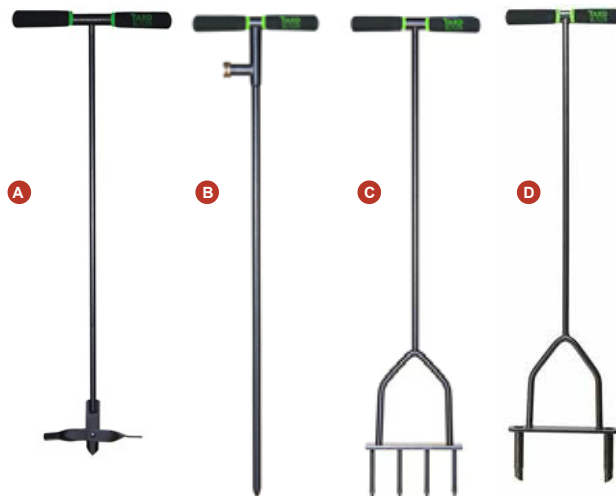

Compost Aerator (A)

The Compost Aerator helps you transform yard and kitchen waste into perfect garden compost. The "harpoon" design turns and mixes the compost and is much easier to use than a pitchfork or shovel. It easily introduces the oxygen needed for microbes and faster decomposition. The 37 inch tall handle eliminates bending over. The heavy-duty powder coated steel is guaranteed to last a lifetime.

Item #	Desc	UPC	Vendor	CS/UOS	Location
80740002	10" W x 37" H	033607360369	CA-36	4/4	National

Deep Root Irrigator (B)

Made with heavy-duty powder-coated steel, the Deep Root Irrigator is sturdy, durable, and rust-resistant. It can withstand years of outdoor use. This irrigation system tool helps save water by eliminating wasteful runoff and evaporation. Measuring 36.2" tall and weighing 2.4 lbs, this irrigator is easy to handle and transport around your yard. It is a convenient and handy tool that every gardener needs in their collection of gardening gadgets and yard tools.

Item #	Desc	UPC	Vendor	CS/UOS	Location
80740004	36.2" tall	033607001040	WST-1	4/4	National

Spike Aerator (C)

The Spike Grass Aerator Black Steel is made of heavy-duty material for efficient and reliable use. Resistant to environmental damage, it ensures superior longevity. It is easy to install for facilitated application. It ensures comprehensive use with its sweeping compatibility with most vehicular models.

Item #	Desc	UPC	Vendor	CS/UOS	Location
80740012	8.5" x 2" x 36"	033607009381	M-7C	4/4	National

Core Aerator (D)

The lawn coring aerator revitalizes old lawns while using less water and fertilizer. By removing two plugs 3 inches long, this manual lawn plug aerator and de-thatcher reduces compaction and thatch to let air, water, and fertilizer down to the root zone. At the same time it stimulates root growth by pruning, the roots. As an added benefit, the removed cores deposit valuable micro-organisms on the lawn surface. This also strengthens drought and heat tolerance in your turf. The heavy-duty powder coated steel handheld lawn corer is built for a lifetime of use.

Item #	Desc	UPC	Vendor	CS/UOS	Location
80740003	10" W x 37" H	033607009473	D-6C	4/4	National



World's Greatest Rakes

Lightweight yet durable rakes for all your gardening needs. Your garden will never look better than when these rakes are by your side. Their free-floating tines and springy steel are gentle enough to rake over garden beds, yet stiff enough to clear leaves off concrete.



Item #	Desc	UPC	Vendor	CS/UOS	Location
80740073	Shrub Rake	033607012084	LT-8	6/6	National
80740072	Rake	033607012206	LT-20	6/6	National

Whisk Rake

With 6 spring steel tines. Handiest tool for hard to reach places.



Item #	Desc	UPC	Vendor	CS/UOS	Location
80740060	Whisk Rake	033607012060	WHR-6	12/12	National

Terra Tiller

The Terra Tuff Tiller is an all purpose double sided garden tool. One side has 3 sturdy prongs for deep tilling in the toughest of soils, the other side has a sharpened blade for chopping through thick ground roots. It is made from heavy duty powder-coated steel with a comfort grip handle. It has a lifetime warranty.



Item #	Desc	UPC	Vendor	CS/UOS	Location
80740058	Terra Tiller	033607003044	TT-4T	12/12	National

Terra Weeder

Meet your new go-to gardening tool. Lock onto even the most stubborn weeds with the Terra Garden Weeder. Use the side with four tapered tines to grip and rip out stubborn weeds, roots, and all. The second edge is perfect for hacking away compacted soils and tough roots.



Item #	Desc	UPC	Vendor	CS/UOS	Location
80740059	Terra Weeder	033607003013	TT-1W	12/12	National



Spray Tank Cleaner

Spray tank cleaner will clean your spray tank equipment to prevent cross contamination of sprays and fertilizer products. Prevent chemical damage to plants. Prolong sprayer life and avoid nozzle clogging.



Item #	Desc	UPC	Vendor	CS/UOS	Location
80820128	1 Pint	022179101647	LG 1140	12/12	West

Mossify®

Garden Utility Shears

Mossify's Garden Utility Shears are the perfect tool for pruning your indoor and outdoor plants. Designed for effortlessly cutting old leaves, damaged branches, and growing vines, these stainless steel shears are an essential addition to your gardening toolkit. Ergonomic wooden handle.



Item #	Desc	UPC	Vendor	CS/UOS	Location
82370055	8"	716252512290	GSHEAR-0001	12/12	National

Slim Garden Utility Shears

The Slim Garden Utility Shears are an essential addition to your gardening kit. These shears boast long, pointy stainless steel blades, giving you the ability to cut back foliage and vines with precision and ease. The comfortable, ergonomic wooden handle ensures a secure grip for those extended pruning sessions.

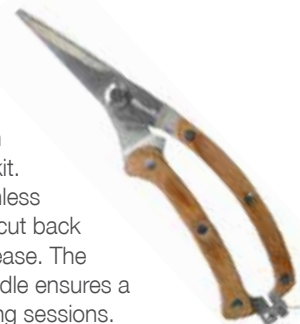

Item #	Desc	UPC	Vendor	CS/UOS	Location
82370056	8.5"	660111997035	SGSHEAR-0002	12/12	National





Battery Powered Back Pack Sprayer

Full-featured sprayer with easy-to-fill funnel top for general purpose spraying, garden applications, pest control, algae and mildew removers. Durable 24" poly wand with adjustable spray nozzle, 45" PVC hose, and shut-off valve assembly. TeeJet® compatible. Includes large pump handle with built in wand retainer and pressure relief valve.



Item #	Desc	UPC	Vendor	CS/UOS	Location
81140038	4 gal.	720343424003	441	1/1	East

4 Gal Professional Piston Pump

Includes these four nozzles: adjustable brass, fan spray, hollow cone, and jet stream. TeeJet® compatible. Features an extra-large carrying handle with a wand retainer for easy portability and storage and a professional-grade adjustable brass nozzle. 28 inch wand, 48 inch nylon-reinforced hose, maximum pressure of 90 psi.



Item #	Desc	UPC	Vendor	CS/UOS	Location
81140025	4 gal.	720343425000	425-101	1/1	East

Backpack Sprayer

High-density polyethylene tank with ultra-violet inhibitors. Large 4 1/4" opening for easy filling and cleaning. Shut-off valve and wand with an overall length of 28" for hard-to-reach places. 4' high-pressure hose. Padded shoulder straps for greater comfort. Chemically resistant Viton® seals insure long life and durability. With its connecting rod-activated piston pump, the 425° is capable of producing a wide pressure range of up to 90 psi, and is capable of performing virtually every spraying task.



Item #	Desc	UPC	Vendor	CS/UOS	Location
41-3130	4 gal.	720343425000	425	1/1	East

One-Hand Sprayer

Chemical-resistant Viton® seals for outstanding resistance to harsh chemicals. Multi-directional nozzle. Unique drift guard for added control for spot treatment. Locking trigger for reduced user fatigue.



Item #	Desc	UPC	Vendor	CS/UOS	Location
81140013	2 liter	720343419009	419	12/12	East



One Hand Sprayer (A)

Lightweight and versatile. These sprayers are perfect for general spraying around your home. Both indoors and out. Weed control, gardening, auto and marine. Livestock applications and more. All offer many of the same features as our larger professional sprayers.

Item #	Desc	UPC	Vendor	CS/UOS	Location
81140008	1 gal.	720343415001	415	12/12	East

Tank Sprayer (B)

Newly designed mid-price range sprayer incorporating a large filler opening and the popular funnel top concept. These have all Viton® seals, long hose, large pump handle and loads of other useful features. Includes an assortment of four nozzles: Adjustable Nozzle for spraying a steam to a mist; Flat Fan Nozzle for area and row application; Hollow Cone Nozzle for shrubs and bushes; and Jet Stream Nozzle for additional reach.

Item #	Desc	UPC	Vendor	CS/UOS	Location
81140005	2 gal.	720343432008	430-2G	1/1	East

2.25 gal Pro Handheld Sprayer (C)

Designed for medium-to-large jobs at home, on the farm, or for professional applications. The ultimate in hand-held sprayers, the 450 series is designed with the professional user in mind. This extremely heavy-duty sprayer will stand up to the toughest of jobs. High-performance, efficient piston pumps pressurize the tanks with as much as 50% more efficiency than the competitor's.

Item #	Desc	UPC	Vendor	CS/UOS	Location
41-3120	2.25 gal	720343456028	456	1/1	East



Home & Garden Handheld Sprayer

A full-featured sprayer in an economical package is perfect for homeowners. Use for general-purpose spraying, gardening applications and pest control.



Item #	Desc	UPC	Vendor	CS/UOS	Location
81140042	1 gal	720343211009	211	1/1	East

All Around Upside Down Sprayer

Rotates 360 degrees allowing gardeners to spray at all angles. Full color graphic label with graduated dilution scale for exact measurement. Adjustable nozzle offers full stream and mist spray.



Item #	Desc	UPC	Vendor	CS/UOS	Location
81670001	32 oz.	046412104196	800419	12/12	National



Chemically Resistant Sprayer

High output dispenses 2.5 times more than standard trigger; Chemically-resistant extra long trigger for extended spray.

Item #	Desc	UPC	Vendor	CS/UOS	Location
81670011	32 oz.	046412076004	800660 DSP	12/12	National
81670018	42 piece Floor Display	046412076004	801660	42/42	National



All Purpose Sprayer

Full color graphic label with graduated dilution scale for exact measurement. Adjustable nozzle offers full stream and mist spray.

Item #	Desc	UPC	Vendor	CS/UOS	Location
81670005	32 oz.	046412118889	800608	12/12	National
81670017	42 piece Floor Display	046412118889	800936	42/42	National



Tapered Square Sprayer

Adjustable nozzle offers full stream or mist, perfect for misting your plants! Assorted case pack. 3 each blue, pink, green and purple

Item #	Desc	UPC	Vendor	CS/UOS	Location
81670009	12oz Assorted	046412103908	801031	12/12	National
81670016	72 piece Floor Display	046412103908	801932	72/72	National

Spray Bottle 3-Pack

Extended easy to press trigger with firm grip for accurate dispensing. Adjustable nozzle full stream and misty spray. Dilution scale for measurement, great for household cleaners, insecticides, weed killers and many other liquids.



Item #	Desc	UPC	Vendor	CS/UOS	Location
81670015	32 oz.	046412079999	801619	4/4	National



Plant & Garden Sprayer

Perfect for indoor and outdoor garden needs. Full color graphic label with graduated dilution scale for exact measurement. Adjustable nozzle offers full stream and mist spray.



Item #	Desc	UPC	Vendor	CS/UOS	Location
81670012	16 oz.	046412907568	800307 DSP	24/24	National

High Tech Clear Sprayer

Fully adjustable spray pattern. Assorted case pack - Orange, Gray, Teal



Item #	Desc	UPC	Vendor	CS/UOS	Location
81670004	14 oz.	046412000603	800201 DSP	12/12	National



Little Pals Tool Pouch Kit

Includes green tool pouch, hand trowel, hand fork and children's garden gloves. Gloves have a wide cuff and extra fabric over the knuckles to help protect little hands. Glove design may vary.

Item #	Desc	UPC	Vendor	CS/UOS	Location
81550787	Pink	501355612463	7-LP463	6/6	National
81550785	Blue	501355612441	7-LP441	6/6	National

Small Hand Tools

These colorful garden tools are perfect for the youngest gardeners ages 3-10! These tools are great for the garden or sandbox. (36 piece assorted case pack contains 12 ea-square, round, and fork hand tools.)



Item #	Desc	UPC	Vendor	CS/UOS	Location
81550823	Square Trowel	692815212856	G340	12/12	National
81550824	Round Trowel	692815212855	G350	12/12	National
81550825	Fork	692815212857	G360	12/12	National
81551163	36-Piece Assorted	017783651039	G330	1/1	National



Thank You Trunk Liners

Large 45" x 38" precut easy tear perforations. 1000 sheets per roll. Plastic Thank You Trunk liners.



Item #	Desc	UPC	Vendor	CS/UOS	Location
81550002	1000 pc.	772911180408	18030	1/1	National

Thank You Biodegradable Trunk Liners

Large 45"x38" precut easy tear perforations, semi-transparent light green polyethylene sheets with a biodegrading agent. 1000 sheets per roll. Biodegrades one month in the sun, five years in a landfill



Item #	Desc	UPC	Vendor	CS/UOS	Location
81550005	1000 pc.	772911180361	18036	1/1	East



WATERING SUPPLIES & IRRIGATION



CHECK OUT OUR
CLEARANCE ITEMS!



Griffin Greenhouse Retail WAREHOUSE Shipping Map

We are now shipping nationwide!

NATIONAL



2025

Refer to location key:

National items are stocked nationally
 Select items are sold East or West only; no exceptions

8" Kaleidoscope Planter

Premium plastic modular planter can be displayed individually each planter has a removable saucer ideal for succulents or shallow rooted planted.

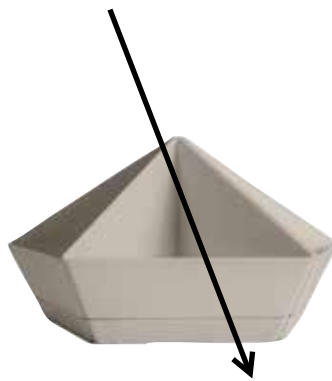

Item #	Desc	UPC	Vendor	CS/UOS	Location
80282643	Vanilla Bisque	770932844170	KDP08000A58	6/6	National

Where is the pricing?

1. Scan QR code on Chapter Pages to see pricing on Griffins.com
2. Contact your Griffin Sales Representative
3. Call into Griffin Customer Service 800.888.0054





bloem

Classic Watering Can Mix

Comfortable, easy-to-use handle. Long stem spout controls water flow. One-piece construction eliminates leaks. 100% UV stabilized polypropylene plastic ensures long lasting color and withstands extreme weather conditions + BPA free. 2gal assortment contains four each of Yellow, Teal, and Blue. Watering can empty display pole, is made of metal and perfect for displaying watering cans inside the garden center or by the register for impulse add on sales.



Item #	Desc	UPC	Vendor	CS/UOS	Location
80922237	2gal Asst	087404003868	JW82-ASST-7	12/12	National
80922167	2gal Bermuda Teal	087404001659	JW82-26	12/12	National

Aqua Rite Mix Watercan Trend

Comfortable, easy-to-use handle. Long stem spout controls water flow. One-piece construction eliminates leaks. 100% UV stabilized polypropylene plastic ensures long lasting color and withstands extreme weather conditions + BPA free. Trendy mix case pack colors are Yellow, Bermuda Teal, and Blue



Item #	Desc	UPC	Vendor	CS/UOS	Location
80922152	56oz-Yellow	814174029589	AW21-23	12/12	National
80922153	56oz-Bermuda Teal	814174029596	AW21-26	12/12	National
80922234	56oz-Classic Blue	087404003783	AW21-33	12/12	National
80922476	56 oz-Mix Trendy	087404012624	AW21-ASST-10	12/12	National
80922236	144oz-Classic Blue	087404003790	JW41-33	6/6	National
80922160	144oz-Bermuda Teal	087404001574	JW41-26	6/6	National
80922159	144oz-Yellow	087404001567	JW41-23	6/6	National
80922235	144oz Mix Trendy	087404003844	JW41-ASST-7	6/6	National

Deluxe Watering Can

Two handle design accommodates multiple hand positions for better maneuverability and water control. Wide mouth for easy filling. Twist off removable spout nozzle cap. 2.5gal capacity. Two each Earthy Yellow, Bermuda Teal, Classic Blue.



Item #	Desc	UPC	Vendor	CS/UOS	Location
80922239	2.5 gal Asst	087404003882	DWC2-ASST-7	6/6	National

Classic Watering Can

Tapered handle ideal for tending potted plants. Deluxe features include large water capacity, wide mouth for easy filling, two handles for easy carrying, and a twist off removable spout nozzle cap. All weather durability with UV protection and thick wall design ensures long lasting use. 4ea Peri-Blue, Mint Green, Fuchsia.



Item #	Desc	UPC	Vendor	CS/UOS	Location
80922553	2 gal	087404013027	JW82-ASST-8	12/12	National

Aqua Rite Watering Can

The Aqua Rite Watering Can is the perfect accessory for soaking small and hard-to-reach plants with its long-stem spout and small opening. The user-friendly handles allow for precise watering and easy carrying. Assorted colors Peri-Blue, Mint Green, and Fuchsia.



Item #	Desc	UPC	Vendor	CS/UOS	Location
80922476	56 oz Mix Trend	087404012624	AW21-ASST-10	12/12	National
80922549	144oz Mix Trend	087404012570	JW41-ASST-8	6/6	National

Watering Can - Living Green

Designed with user-friendly handles for precise watering and easy carrying. Tapered handle ideal for tending potted plants. Deluxe features include large water capacity, wide mouth for easy filling, 2 handles for easy carrying. Capacity: 2 Gal./Size: 20.5 in. Top width x 20.5 in. Bottom width x 14 in. H x 6.75 in.



Item #	Desc	UPC	Vendor	CS/UOS	Location
80921851	2 gal	814174027141	JW82PROMO-42	10/10	National





bloem



Fern Watering Can

A sleek modern design, with a long spout for easy watering. Constructed of high-quality durable plastic. Maintenance free and easy to clean. UV-protected for fade resistance. Cement color

Item #	Desc	UPC	Vendor	CS/UOS	Location
80922417	1.5L	0847404007859	FWC1-907	10/10	National

Gold Finch Watering Can

This watering can is great for both indoor & outdoor watering needs. Provides easy visibility to water level. Water level markings are shown in gallon & liters for easy measuring. The loop handle offers multiple hand positioning for better maneuverability & control when watering.



Item #	Desc	UPC	Vendor	CS/UOS	Location
80921700	1.5L	087404341571	434157-4004	10/10	National

Sparrow Plastic Watering Can

Introducing our modern Sparrow 1.5 liter Watering Can with an ergonomic handle. Perfect for small to medium-sized plants, it's designed for comfortable use and features a sleek, stylish design. Whether you're an experienced gardener or just starting out, this watering can is a must-have tool for your plants.



Item #	Desc	UPC	Vendor	CS/UOS	Location
80922419	1.5L	087404007125	SWC1599	12/12	National

Bluebonnet Watering Can

This watering can is perfect for making both indoor and outdoor watering easier. It features a translucent color palette for easy visibility to the water level. The water level markings are shown in gallons and liters for easy measuring. The loop handle offers multiple hand positioning for better maneuverability and control when watering. 5.8"D x 14.7"W x 10"H



Item #	Desc	UPC	Vendor	CS/UOS	Location
80921699	1 gal	814174027141	434017-4004	10/10	National



Transparent Watering Can

1.4L indoor watering can. Assorted colors, two each of transparent green, red, yellow, dark blue, gray, and teal.

Item #	Desc	UPC	Vendor	CS/UOS	Location
82010747	1.4 Lt.-6 Asst	721082225500	V550	12/12	National



Haws Langley Sprinkler Watering Can

Our lightweight watering can is perfect for all ages, even kids. The ergonomic handle and small capacity make it easy to fill and pour. 2 of each color: blue, duck egg blue, green, and sage.

Item #	Desc	UPC	Vendor	CS/UOS	Location
82010103	0.5L Assorted	5012868150105	V127	10/10	National



Hose End Sprayer Auto Mix

Simple to use, automatically mixes and applies the proper water to product dilution. No mixing, no measuring necessary, just hook up to garden hose. Unused concentrate can be returned to the original container. Twelve different mix settings with three spray patterns.



Item #	Desc	UPC	Vendor	CS/UOS	Location
80100047	Auto Mix	037321000518	051	6/6	National



Multi-Purpose Sprayer

A great tool to keep on your greenhouse tool shelf. Light in weight, these handheld sprayers are great for small jobs or detailed work.



Item #	Desc	UPC	Vendor	CS/UOS	Location
82210002	48 oz.	023883010027	1002	6/6	National
82210027	2L/67oz	023883100315	10031	6/6	National

Chapin Sprayer

For the quick and simple jobs around the house, inside and out. These units are compatible with common herbicides, pesticides, fertilizers and general cleaners. Both also, come with an ergonomic pump handle, poly wand with comfortable trigger shut-off, adjustable cone nozzle, and an in-tank filter for continuous spraying.



Item #	Desc	UPC	Vendor	CS/UOS	Location
82210029	1gal Home & Garden	023883161002	16100	1/1	National
82210031	1gal Multi-Purpose	023883200008	20000	1/1	National
82210030	2gal Home & Garden	023883162009	16200	1/1	National
82210032	2gal Multi-Purpose	023883200022	20002	1/1	National
82210033	3gal Multi-Purpose	023883200039	20003	1/1	National

Poly Knapsack Sprayer

Designed for a turf professional in mind, this 4 gallon translucent tank contains a 3 stage filtration and positional pump handle allows you to comfortably control this unit whether you're left or right handed. It comes with chemical-resistant seals for harsher weed control, pest control or fertilizers. Multiple nozzles are included.



Item #	Desc	UPC	Vendor	CS/UOS	Location
82210059	4gal/15.1L	023883618001	61800	1/1	National

Wet or Dry Spray Hose

Whether you're fertilizing your plants, spraying to rid your yard of pesky weeds, or stopping insects from infiltrating your property, you can use both liquid or water-soluble lawn and garden chemicals in this sprayer. Attach to the end of a standard garden hose and it automatically mixes just the right amount of chemical with water.



Item #	Desc	UPC	Vendor	CS/UOS	Location
82210128	32 oz	023883060152	G6015	4/4	National

Zone Water Timer

Chapin makes it easy and affordable to add a water timer to your home garden system. Water timers regulate the amount of water consumed and can comply with municipal watering restrictions.



Item #	Desc	UPC	Vendor	CS/UOS	Location
82210142	Single Zone Timer	023883410117	41011	10/10	National
82210140	Dual Zone Water	023883410131	41013	1/1	National

Lawn & Garden Hose-end Sprayer

Hose end sprayers cover more ground when you're spraying rows of shrubs, large flower beds and vegetable gardens. You are able to spray fertilizers, pesticides and herbicides without mixing concentrate first. Chapin's 362D hose end sprayer with metering dial features a durable poly tank with comfort-grip handle, built-in anti-siphon to prevent backflow and brass mixing head with 16 mixing ratios. Switch from teaspoons to tablespoons for mixing measurements. It's made to fit any standard size garden hose and sprays up to 320 gallons from 32 ounces of concentrate. Fill, set and spray - it automatically mixes liquid concentrate with water. Made in the USA with global materials.



Item #	Desc	UPC	Vendor	CS/UOS	Location
82210122	32oz Hose End Sprayer	023883000097	G362D	6/6	National

Hose End Sprayer for Water Soluble Materials

Chapin's G390 20-gallon hose-end lawn sprayer fits onto any hose end and offers up to 20-gallons of finished spray with a 32-ounce chemical tank. A built-in anti-siphon feature prevents backflow into your water supply; fingertip on/off controls; durable, chemical-resistant and rustproof polyethylene construction. It automatically mixes liquid concentrate with water. Made in the USA with global materials.



Item #	Desc	UPC	Vendor	CS/UOS	Location
82210124	20gal Hose End	023883000035	G390	6/6	National

32-ounce Multi-purpose Trigger Sprayer

Chapin's 1055 trigger sprayer is compatible with common fertilizers, weed killers and pesticides. It's great for everyday tasks around the home, garden, cleaning or in the garage. This 32-ounce sprayer has a translucent plastic bottle so you easily see how full it is.



Item #	Desc	UPC	Vendor	CS/UOS	Location
82210005	32oz/1L	023883010553	1055	12/12	National



Waterfall Watering Can

The single-handed design eliminates back twisting, while gravity helps the handle slip gently through the fingers - the emptier the can gets, the more it tips.



Item #	Desc	UPC	Vendor	CS/UOS	Location
81380791	5 litre	810256013354	GTW/W5DG	2/2	National
81380792	9 litre	810256019066	GTW/W9DG	2/2	National

Indoor Watering Can

This stylish indoor watering can is the perfect marriage of design and performance. The slender spout is perfect for delivering water just where it's needed - and nowhere else. The smooth FSC beech wood handle is extremely tactile and feels beautiful in the hand, giving precise control over pouring. And the watering can is beautifully moulded in steel for a smooth, flawless finish, with a tough powder coating to ensure it stays looking good.



Item #	Desc	UPC	Vendor	CS/UOS	Location
81380725	Charcoal	810256017956	GEN/ICCHARC	4/4	National
81380726	Stone	810256017505	GEN/ICSTONE	4/4	National

Indoor Plant Mister

Give houseplants the gentle humidity they crave with this indoor plant mister. An essential item of equipment for any houseplant fan, the mister is ideal for caring for tropical houseplants, orchids, terrariums and succulents. It's the perfect way to give soft hydration to moisture-loving plants without soaking the compost.



Item #	Desc	UPC	Vendor	CS/UOS	Location
81380727	Charcoal	810256019103	GEN/MISTCHARC	4/4	National
81380728	Stainless Steel	810256019097	GEN/MISTSS	4/4	National
81380729	Stone	810256019080	GEN/MISTSTONE	4/4	National

British Meadow Indoor Watering Can

This mini watering can for indoor plants is more than stylish enough to leave on show. It's perfectly balanced and features an elegant slender spout to ensure the water only goes into the plant pot! In strong galvanized steel with a tough powder coating, this handy watering can is just the thing for indoor gardening.



Item #	Desc	UPC	Vendor	CS/UOS	Location
81380770	1 litre	810256018885	GRH/WCANBM	2/2	National



Tree Water Bags Dew Right

Tree watering bag designed to provide a drip irrigation system directly to roots over an extended period of time. Continuously waters for up to 8 hours.



Item #	Desc	UPC	Vendor	CS/UOS	Location
80010042	Tree Watering Bag	042579822782	TWBAG-12	12/12	National
80010093	Tree Watering Bag	042579822782	TWBAG-36	36/36	National



One Touch Revolution Revolver Display

24ea - 30" OneTouch Rain Wands
24ea - 16" OneTouch Rain Wands
18ea - Revolver Spray Guns
18ea - Revolution Spray Guns
12ea - Pistol Spray Guns
12ea - Shower and Stream
12ea - OneTouch Fan Nozzle
+Display



Item #	Desc	UPC	Vendor	CS/UOS	Location
80170207	Display	036434601100	60110	1/1	West



Patio Plant Wand

The Patio Wand is perfect for watering plants that are in containers on patios, decks and porches. It produces a concentrated stream that allows watering to your plants, not your patio! The shut off valve is easy to use and it is great for the environment by reducing water consumption by just watering where you need it. Comes with a comfortable foam grip for hours of use.

Item #	Desc	UPC	Vendor	CS/UOS	Location
80170031	16" Carded	036434223487	1022348	6/6	West



Classic Container Rain Wand

The Classic Rain Wand is designed for container watering on decks, porches, and patios. The narrow, mid-flow spray pattern provides fast watering for hanging baskets, potted plants without damage or disturbing soil.

Item #	Desc	UPC	Vendor	CS/UOS	Location
80170034	16" Handle & Shut-Off	036434123480	1012348	8/8	West

DRAMM

ColorStorm™ Water Timer

Carded. Mechanical water timer. Turns water off automatically. Up to 120 minute run time.

Assorted : 1 red, 1 orange, 1 yellow, 1 green, 1 blue and 1 berry.



Item #	Desc	UPC	Vendor	CS/UOS	Location
80170299	Red	036434150417	1015041	6/6	West
80170303	Blue	036434150455	1015045	6/6	West
80170300	Orange	036434150424	1015042	6/6	West
80170301	Yellow	036434150431	1015043	6/6	West
80170304	Berry	036434150462	1015046	6/6	West
80170302	Green	036434150448	1015044	6/6	West
80170021	Timer Asst Colors	036434150400	10-15040	6/6	National

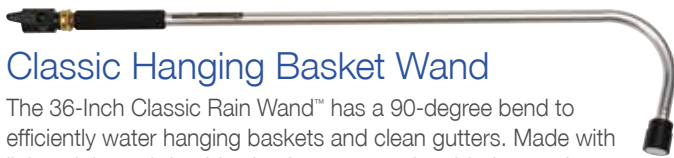

Classic Hanging Basket Wand

The 36-Inch Classic Rain Wand™ has a 90-degree bend to efficiently water hanging baskets and clean gutters. Made with lightweight and durable aluminum, a comfortable foam grip, and equipped with the QAV Shut-Off. Made in the USA.

Item #	Desc	UPC	Vendor	CS/UOS	Location
80170035	Uncarded	036434123589	10-12358	6/6	East



Handi-Reach™ Handle

Designed to eliminate the stretching and stooping associated with hand watering. These rugged tools allow you to water hard-to-reach areas with ease. Made from extruded aluminum tubing, forged brass hose couplings and a comfort EPDM hand grip. 3/4" male and female hose threads. Made in the USA.

Item #	Desc	UPC	Vendor	CS/UOS	Location
80170093	30" Carded	036434123626	10-12362	10/10	West
80170091	48" Carded	036434123572	1012357	6/6	West



Classic Rain Wand™

Gentle full flow for quick thorough watering. Comfortable foam rubber grip. The Classic Rain Wand™ has a sleek silver wand with water breaker head & shut-off valve. The rain wand can come with or without a vinyl card for pegboard display.

Item #	Desc	UPC	Vendor	CS/UOS	Location
80170033	24" Uncarded	036434123411	1012341	24/24	National
80170004	30" Uncarded	036434123459	10-12345	24/24	National
80170022	30" Carded	036434223456	10-22345	12/12	National

Touch 'N Flow™ Rain Wand™

The Touch 'N Flow Rain Wand is equipped with a one-touch lever activated valve. Simply squeeze the lever to water and release the lever to stop watering while moving from one plant to the next.

Assortment: 3 berry, 2 blue, 3 green, 1 yellow, 1 orange & 2 red



Item #	Desc	UPC	Vendor	CS/UOS	Location
80170415	16" - Berry	036434128669	6012866	6/6	West
80170414	16" - Blue	036434128652	6012865	6/6	West
80170413	16" - Green	036434128645	6012864	6/6	West
80170412	16" - Red	036434128614	6012861	6/6	West
80170014	16" Assorted	036434128607	10-12860	12/12	West
80170411	30" - Berry	036434128065	6012806	6/6	West
80170410	30" - Blue	036434128058	6012805	6/6	West
80170409	30" - Green	036434128041	6012804	6/6	West
80170408	30" - Yellow	036434128034	6012803	6/6	West
80170407	30" - Orange	036434128027	6012802	6/6	West
80170406	30" - Red	036434128010	6012801	6/6	West
80170013	30" Uncarded Assorted	036434128126	10-12812	12/12	National

One Touch™ Rain Wand™

Allows complete and total water flow control with one touch of your thumb. Efficiently saves water while watering from one plant to the next. Made with heavy-duty aluminum for lightweight feel.

Assorted case pack contains: berry, blue, green, orange, yellow and red.



Item #	Desc	UPC	Vendor	CS/UOS	Location
80170461	16" - Berry	036434148667	6014866	6/6	West
80170460	16" - Blue	036434148650	6014865	6/6	West
80170459	16" - Green	036434148643	6014864	6/6	West
80170458	16" - Red	036434148612	6014861	6/6	West
80170045	16" Assorted	036434148602	10-14860	12/12	National
80170203	RainSelect Asst	036434136104	1013610	12/12	West
80170457	30" - Berry	036434148063	6014806	6/6	West
80170456	30" - Blue	036434148056	6014805	6/6	West
80170455	30" - Green	036434148049	6014804	6/6	West
80170454	30" - Yellow	036434148032	6014803	6/6	West
80170453	30" - Orange	036434148025	6014802	6/6	West
80170452	30" - Red	036434148018	6014801	6/6	West
80170044	30" Assorted	036434148008	10-14800	12/12	National

DRAMM

Kaleidoscope™ Rain Wand™

The kaleidoscope rain wand is the perfect tool for watering anything while efficiently saving on water. The seven patterns vary from a fine mist setting for seedlings, to the shower setting for mature plants and flowers. The seven patterns include sweeper, jet, shower, mist, flood, cone and flat.



Assorted case pack contains: berry, blue, green, orange, yellow and red.

Item #	Desc	UPC	Vendor	CS/UOS	Location
80170439	16" - Berry	036434138668	6013866	6/6	West
80170438	16" - Blue	036434138651	6013865	6/6	West
80170437	16" - Green	036434138644	6013864	6/6	West
80170436	16" - Red	036434138613	6013861	6/6	West
80170017	16" Assorted	036434138606	10-13860	12/12	West
80170435	30" - Berry	036434138064	6013806	6/6	West
80170434	30" - Blue	036434138057	6013805	6/6	West
80170433	30" - Green	036434138040	6013804	6/6	West
80170431	30" - Orange	036434138026	6013802	6/6	West
80170432	30" - Yellow	036434138033	6013803	6/6	West
80170430	30" - Red	036434138019	6013801	6/6	West
80170016	30" Assorted	036434138125	10-13812	12/12	National

RainSelect™ Rain Wand™

Select one of nine water patterns with the simple turn of a dial. Allows complete and total water flow control with just one touch of your thumb. Made with aluminum for a lightweight and durable feel. Available in six enticing colors.



Assorted case pack contains: berry, blue, green, orange, yellow and red.

Item #	Desc	UPC	Vendor	CS/UOS	Location
80170425	16" - Berry	036434136169	6013616	6/6	West
80170424	16" - Blue	036434136152	6013615	6/6	West
80170423	16" - Green	036434136145	6013614	6/6	West
80170422	16" - Red	036434136114	6013611	6/6	West
80170421	30" - Berry	036434136060	6013606	6/6	West
80170420	30" - Blue	036434136053	6013605	6/6	West
80170419	30" - Green	036434136046	6013604	6/6	National
80170418	30" - Yellow	036434136039	6013603	6/6	West
80170417	30" - Orange	036434136022	6013602	6/6	West
80170416	30" - Red	036434136015	6013601	6/6	West
80170202	30" Assorted	036434136005	10-13600	12/12	National

Sunrise™ Rain Wand™

Uncarded. Comfortable foam grip. Large, easy-to-use shut-off valve. Gentle, full flow for quick watering. Professional grade materials. Consumer lifetime guarantee. Made in the USA.



Assorted case pack contains: berry, blue, green, orange, yellow and red.

Item #	Desc	UPC	Vendor	CS/UOS	Location
80170379	16" - Berry	036434126030	6012603	6/6	West
80170377	16" - Blue	036434126016	6012601	6/6	West
80170378	16" - Green	036434126023	6012602	6/6	West
80170381	16" - Yellow	036434126054	6012605	6/6	West
80170380	16" - Orange	036434126047	6012604	6/6	West
80170376	16" - Red	036434126009	6012600	6/6	West
80170037	16" Assorted	036434120127	10-12012	12/12	National
80170373	30" - Berry	036434125835	6012583	6/6	West
80170371	30" - Blue	036434125811	6012581	6/6	West
80170372	30" - Green	036434125828	6012582	6/6	West
80170375	30" - Yellow	036434125880	6012582	6/6	West
80170374	30" - Orange	036434125873	6012587	6/6	West
80170370	30" - Red	036434125804	6012580	6/6	West
80170038	30" Assorted Uncarded	036434100129	10-10012	12/12	National
80170040	30" Assorted carded	036434000095	10-00009	12/12	National

ColorMark™ Rain Wand™

This superbly balanced 30-Inch Rain Wand is used by professional growers and horticulturists worldwide. It provides a gentle, full-flow shower. It has a handcrafted brass shut-off and a foam grip for comfortable watering. Available in six rich colors and made in the USA.

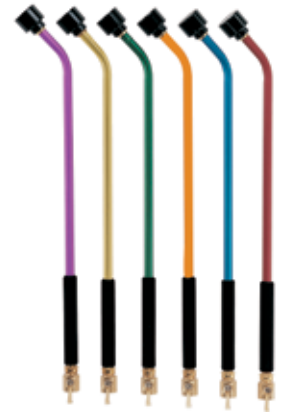

Assorted case pack contains: berry, blue, green, orange, yellow and red.

Item #	Desc	UPC	Vendor	CS/UOS	Location
80170368	30" - Berry	036434125033	6012503	6/6	West
80170474	30" - Gold	036434224316	6022341	6/6	West
80170367	30" - Green	036434125026	6012502	6/6	West
80170369	30" - Orange	036434125040	6012504	6/6	West
80170366	30" - Blue	036434125019	6012501	6/6	West
80170365	30" - Red	036434125002	6012500	6/6	West
80170041	30" Assorted	036434100006	10-10000	12/12	National

DRAMM



400 Plastic Water Breaker® Nozzle (A)

Provides fast, full-flow watering without damage to your plants. Professional's lightweight alternative to the 400AL. ABS plastic & aluminum. Gentle, full flow at 11.1 gpm. Used by professional growers worldwide. Has 3/4" hose threads. Made in the USA.

Item #	Desc	UPC	Vendor	CS/UOS	Location
80170179	Carded	036434123466	60-12346	6/6	National

170 Plastic Water Breaker® Nozzle (B)

Patterned after the 170 Aluminum water breaker. An excellent choice for watering in areas with low water pressure or with systems which restrict total water volume. It is designed for small containers (hanging baskets). Adjust water flow to 50% of its possible volume. Made from ABS plastic. 3/4" hose threads. Made in the USA.

Item #	Desc	UPC	Vendor	CS/UOS	Location
80170180	Carded	036434123497	60-12349	6/6	National

170 Aluminum Water Breaker® Nozzle (C)

Excellent for watering in areas with low water pressure or with systems which restrict total water volume. It is designed for small containers (hanging baskets), and when using fertilizer siphons. Adjust water flow to 50% of its possible volume. Cast aluminum with 3/4" brass hose threads. Made in the USA.

Item #	Desc	UPC	Vendor	CS/UOS	Location
80170177	Carded	036434123435	60-12343	6/6	National

400 Die Cast Aluminum Water Breaker (D)

The 400DC Water Beaker is a lighter weight version of the original Aluminum 400 Water Breaker. Designed for the greenhouse and nurseryman, this lightweight nozzle saves time and water. 400 tiny holes provide a gentle, full-flow shower for flowers. Simply attached the nozzle to the end of your hose to water.

Item #	Desc	UPC	Vendor	CS/UOS	Location
80170176	Carded	036434123428	60-12342	6/6	National

1000 Plastic Water Breaker® Nozzle

The 1000PL Water Breaker Nozzle is great for container and garden bed watering. Originally designed for greenhouses and nurseryman, this lightweight nozzle has 1000 tiny holes to provide an ultra-soft, full-flow shower for flowers. Simply attached the nozzle to the end of your hose and away you go. Won't harm delicate soil or tender plants and seedlings. Made in the U.S.A. with a highly durable plastic and comes with a manufacturer's consumer lifetime guarantee.



Item #	Desc	UPC	Vendor	CS/UOS	Location
80170174	Carded	036434110008	60-11000	6/6	National



Garden Gard™ Hose Guides (E)

Box Display. Guides hose around flowers, shrubs and sharp corners. Pulling hose is easy with spinning post design. Quick mowing with removable post design. Made in the USA.

Item #	Desc	UPC	Vendor	CS/UOS	Location
80170015	Hose Guides	036434130013	1013001	12/12	West

Brass Hose Swivel (F)

Live swivel that allows for unencumbered movement between the hose & attachments under pressure. Reduces hose twisting. Made in the USA.

Item #	Desc	UPC	Vendor	CS/UOS	Location
80170199	Brass	036434138255	60-13825	6/6	West

Carded Replacement Washers (G)

Great for leak-free hose connections in all standard 3/4" garden hose couplings. Molded from high-quality virgin neoprene. Dramm washers stay soft and pliable for years, while common nylon washers become brittle with age.

Item #	Desc	UPC	Vendor	CS/UOS	Location
80170175	3/4"	036434123404	60-12340	6/6	West

Brass Adjustable Nozzle (H)

Adjustable Hose Nozzle is a great cleanup nozzle for walkways, patios and gutters, and also works to gently water and rinse your plants.

Item #	Desc	UPC	Vendor	CS/UOS	Location
80170185	Adjustable Nozzle	036434123800	6012380	6/6	National



One Touch Shower & Stream™

Complete & total water flow control with just on touch of your thumb. Has two pattern options: Shower, for a cascading flow of fine water droplets that will not harm your plants, and Stream, a concentrated jet. Assorted case pack contains: berry, blue, green, orange, yellow and red.



Item #	Desc	UPC	Vendor	CS/UOS	Location
80170346	Berry	036434124265	6012426	6/6	West
80170345	Blue	036434124258	6012425	6/6	West
80170344	Green	036434124241	6012424	6/6	West
80170343	Yellow	036434124234	6012423	6/6	West
80170342	Orange	036434124227	6012422	6/6	West
80170341	Red	036434124210	6012421	6/6	West
80170048	Assorted Carded	036434124203	10-12420	12/12	National

Revolution™ 9-Pattern Spray Gun

Easily switch between water flow selections with the quick-change feature. Equipped with the One Touch Valve allowing complete and total water flow control with just one touch of the thumb. It has an ergonomic design, is constructed from heavy-duty metal. The spray gun can come with or without a vinyl card for pegboard display. Assorted case pack contains: berry, blue, green, orange, yellow and red.



Item #	Desc	UPC	Vendor	CS/UOS	Location
80170445	Berry Uncarded	036434145062	6014506	6/6	West
80170444	Blue Uncarded	036434145055	6014505	6/6	West
80170443	Green Uncarded	036434145048	6014504	6/6	West
80170442	Yellow Uncarded	036434145031	6014503	6/6	West
80170441	Orange Uncarded	036434145024	6014502	6/6	West
80170440	Red Uncarded	036434145017	6014501	6/6	West
80170162	Assorted Uncarded	036434145007	10-14500	12/12	National
80170486	Berry Carded	036434245069	6024506	6/6	West
80170485	Blue Carded	036434245052	6024505	6/6	West
80170484	Green Carded	036434245045	6024504	6/6	West
80170483	Yellow Carded	036434245038	6022704	6/6	West
80170482	Orange Carded	036434245021	6024502	6/6	West
80170481	Red Carded	036434245014	6022702	6/6	West
80170166	Assorted Carded	036434345001	10-34500	12/12	National



Pistol™ Spray Gun

Revised to closely resemble the Dramm's Revolver™ Spray Gun. Redesigned with a larger barrel for a more consistent spray pattern and a insulated comfort grip for a better look and feel. Made with a heavy-duty metal for a longer life. Assorted case pack contains: berry, blue, green, orange, yellow and red.

Item #	Desc	UPC	Vendor	CS/UOS	Location
80170399	Berry	036434127266	6012726	6/6	West
80170398	Blue	036434127259	6012725	6/6	West
80170397	Green	036434127242	6012724	6/6	West
80170396	Yellow	036434127235	6012723	6/6	West
80170395	Orange	036434127228	6012722	6/6	West
80170394	Red	036434127211	6012721	6/6	West
80170012	Assorted Uncarded	036434127204	10-12720	12/12	National

Revolver™

Durable metal with nine spray patterns. Has an Ergonomic insulated grip. Made with heavy-duty construction. Quick-click pattern changing. Assorted case pack contains: berry, blue, green, orange, yellow and red.



Item #	Desc	UPC	Vendor	CS/UOS	Location
80170387	Berry Uncarded	036434127068	6012706	6/6	West
80170386	Blue Uncarded	036434127051	6012705	6/6	West
80170385	Green Uncarded	036434127044	6012704	6/6	West
80170384	Yellow Uncarded	036434127037	6012703	6/6	West
80170383	Orange Uncarded	036434127020	6012702	6/6	West
80170382	Red Uncarded	036434127013	6012701	6/6	West
80170011	Assorted Uncarded	036434127006	10-12700	12/12	National
80170480	Berry Carded	036434227065	6022706	6/6	West
80170479	Blue Carded	036434227058	6022705	6/6	West
80170478	Green Carded	036434227041	6022704	6/6	West
80170477	Yellow Carded	036434227034	6022703	6/6	West
80170476	Orange Carded	036434227027	6022702	6/6	West
80170475	Red Carded	036434227010	6022701	6/6	West
80170025	Assorted Carded	036434137005	10-32700	12/12	National

DRAMM



One Touch™ Fan Nozzle



Corrosion proof head creates a precise and gentle water pattern that won't harm delicate plants and seedling – Great for watering containers, plants and shrubbery. Assorted: 2 red, 2 orange, 2 yellow, 2 green, 2 blue, 2 berry.

Item #	Desc	UPC	Vendor	CS/UOS	Location
80170405	Berry	036434127365	6012736	6/6	West
80170404	Blue	036434127358	6012735	6/6	West
80170403	Green	036434127341	6012735	6/6	West
80170402	Yellow	036434127334	6012733	6/6	West
80170401	Orange	036434127327	6012732	6/6	West
80170400	Red	036434127310	6012731	6/6	West
80170047	Assorted Carded	036434127300	10-12730	12/12	National



Fan Nozzle



Heavy duty metal with 1/4 turn valve. Ergonomic insulated grip. Limited lifetime guarantee. Assorted case pack contains: berry, blue, green, orange, yellow and red.

Item #	Desc	UPC	Vendor	CS/UOS	Location
80170393	Berry	036434127167	6012716	6/6	West
80170392	Blue	036434127150	6012715	6/6	West
80170391	Green	036434127143	6012714	6/6	West
80170390	Yellow	036434127136	6012713	6/6	West
80170389	Orange	036434127129	6012712	6/6	West
80170388	Red	036434127112	6012711	6/6	West
80170046	Assorted Colors	036434127102	10-12710	12/12	West



Sunrise™ Hanging Basket Wand

The 36-Inch Sunrise Hanging Basket Wand™ has a 90-degree bend to efficiently water hanging baskets and clean gutters. Made with lightweight and durable aluminum, a comfortable foam grip, and equipped with the QAV Shut-Off. Made in the USA and available in blue.

Item #	Desc	UPC	Vendor	CS/UOS	Location
80170039	36"	036434125798	10-12579	6/6	West

One Touch™ Adj Twist Nozzle

What a great tool for cleaning decks, sidewalks, cars and more! Dramm's "Twist" Adjustable Spray Gun's spray pattern can be adjusted from a cone of fine mist all the way up to a powerful jet for quick and easy cleanup. Assorted case pack contains: berry, blue, green, orange, yellow and red.



Item #	Desc	UPC	Vendor	CS/UOS	Location
80170451	Berry	036434145161	6014516	6/6	West
80170450	Blue	036434145154	6014515	6/6	West
80170449	Green	036434145147	6014514	6/6	West
80170448	Yellow	036434145130	6014513	6/6	West
80170447	Orange	036434145123	6014512	6/6	West
80170446	Red	036434145116	6014511	6/6	West



Telescoping Rain Wand

9 Pattern nozzle with thumb controlled valve. Versatile watering tool for those hard to reach places. Adjustable length from 34 inches to 55 inches puts all your watering jobs within reach.

Item #	Desc	UPC	Vendor	CS/UOS	Location
80170429	Berry	036434136268	6013626	6/6	West
80170428	Blue	036434136251	6013625	6/6	West
80170427	Green	036434136244	6013624	6/6	West
80170426	Red	036434136213	6013621	6/6	West

ColorStorm™ Pattern Gear Sprinkler

Mounted to a die-cast metal sled base, the gear drive sprinkler is a great mobile, flexible sprinkler for a variety of watering applications.

Each pattern can be selected by the simple twist of the selector dial.

Lifetime consumer guarantee.



Item #	Desc	UPC	Vendor	CS/UOS	Location
80170334	Berry	036434150967	1015096	6/6	West
80170333	Blue	036434150950	1015095	6/6	West
80170332	Green	036434150943	1015094	6/6	West
80170331	Yellow	036434150936	1015093	6/6	West
80170330	Orange	036434150929	1015092	6/6	West
80170329	Red	036434150912	1015091	6/6	West

DRAMM

Stake Impulse Sprinkler

Carded. Durable metal with an all brass sprinkler head. Up to 80' diameter. Has a 6" stake with step. Assorted case pack contains: berry, blue, green, orange, yellow and red.



Item #	Desc	UPC	Vendor	CS/UOS	Location
80170312	Orange	036434150622	1015062	6/6	West
80170311	Red	036434150615	1015061	6/6	West
80170313	Yellow	036434150639	1015063	6/6	West
80170316	Berry	036434150660	1015056	6/6	West
80170315	Blue	036434150653	1015065	6/6	West
80170314	Green	036434150646	1015064	6/6	West
80170050	Assorted	036434150506	10-15060	6/6	National

Circular Base Impulse Sprinkler

Made with a heavy-duty circular metal base for increased stability and a unique style. The all brass sprinkler head has adjustable partial and full circle patterns with water coverage up to 70 Ft. in diameter. Backed with a lifetime guarantee to the consumer Assorted includes: red, orange, yellow, green, blue and berry.



Item #	Desc	UPC	Vendor	CS/UOS	Location
80170326	Green	036434150844	1015084	6/6	West
80170323	Red	036434150813	1015081	6/6	West
80170327	Blue	036434150851	1015085	6/6	West
80170324	Orange	036434150820	1015082	6/6	West
80170328	Berry	036434150868	1015086	6/6	West
80170325	Yellow	036434150837	1015083	6/6	West
80170052	Assorted	036434150608	10-15080	6/6	National

2025

ColorStorm™ Impulse Sprinkler

Durable metal with an all brass sprinkler head. Waters up to 70' diameter. Assorted includes: red, orange, yellow, green, blue, berry.



Item #	Desc	UPC	Vendor	CS/UOS	Location
80170293	Red	036434150318	1015031	6/6	West
80170294	Orange	036434150325	1015032	6/6	West
80170295	Yellow	036434150332	1015033	6/6	West
80170296	Green	036434150349	1015034	6/6	West
80170297	Blue	036434150356	1015035	6/6	West
80170298	Berry	036434150363	1015036	6/6	West
80170020	Assorted	036434150308	10-15030	6/6	National

ColorStorm™ Turret Sprinkler

Heavy-duty metal base with molded hook for convenient storage. Nine water patterns. Assorted includes: red, orange, yellow, green, blue, berry.



Item #	Desc	UPC	Vendor	CS/UOS	Location
80170292	Berry	036434150264	1015026	6/6	West
80170291	Blue	036434150257	1015025	6/6	West
80170290	Green	036434150240	1015024	6/6	West
80170289	Yellow	036434150233	1015023	6/6	West
80170288	Orange	036434150226	1015022	6/6	West
80170287	Red	036434150219	1015021	6/6	West
80170019	Assorted	036434150202	10-15020	6/6	National

Whirling Sprinkler

Heavy-duty metal wheeled base. Available in 6 brilliant colors: red, orange, yellow, green, blue and berry. Water coverage up to 38 Ft. in diameter Durable metal 3 arm sprinkler head Made from zinc, brass, and heavy-duty plastic. Assorted includes: red, orange, yellow, green, blue, berry.



Item #	Desc	UPC	Vendor	CS/UOS	Location
80170305	Red	036434150516	1015051	6/6	West
80170306	Orange	036434150523	1015052	6/6	West
80170307	Yellow	036434150530	1015053	6/6	West
80170308	Green	036434150547	1015054	6/6	West
80170309	Blue	036434150554	1015055	6/6	West
80170310	Berry	036434150561	1015056	6/6	West
80170049	Assorted	036434150608	1015050	6/6	National

ColorStorm™ Spinning Sprinkler

Keep your lawn and other growing things happy even in the heat with the Dramm ColorStorm Spinning Sprinkler. The motion of this unit atomizes water into small droplets, leading to better absorption and more efficient watering.. Assorted includes: red, orange, yellow, green, blue, berry.



Item #	Desc	UPC	Vendor	CS/UOS	Location
80170322	Berry	036434150769	1015076	6/6	West
80170321	Blue	036434150752	1015075	6/6	West
80170320	Green	036434150745	1015074	6/6	West
80170319	Yellow	036434150738	1015073	6/6	West
80170318	Orange	036434150721	1015072	6/6	West
80170317	Red	036434150714	1015071	6/6	West

DRAMM

Oscillating Sprinkler

Re-engineered drive system for longer life. Newly designed housing for increased stability. Enlarged pattern controls for ease of adjustment. Variable settings allow coverage up to 3,036 sq. ft. Assorted case pack contains: berry, blue, green, orange, yellow and red.



Item #	Desc	UPC	Vendor	CS/UOS	Location
80170281	Red	036434150011	1015001	6/6	West
80170282	Orange	036434150028	1015002	6/6	West
80170283	Yellow	036434150035	1015003	6/6	West
80170284	Green	036434150042	1015004	6/6	West
80170285	Blue	036434150059	1015005	6/6	West
80170286	Berry	036434150066	1015006	6/6	West
80170018	Assorted	036434150004	10-15000	6/6	National



ColorStorm™ Premium Rubber Hose

Hot water resistant up to 160°F. Resists kinking. Coils easily even in cold weather. Crush proof, nickel plated coupling. 5/8"X50'

Item #	Desc	UPC	Vendor	CS/UOS	Location
80170335	Red	036434170019	1017001	6/6	West
80170336	Orange	036434170026	1017002	6/6	West
80170337	Yellow	036434170033	1017003	6/6	West
80170338	Green	036434170040	1017004	6/6	West
80170339	Blue	036434170057	1017005	6/6	West
80170340	Berry	036434170064	1017006	6/6	West
80170053	Assorted	10036434170009	10-17000	6/6	West

ColorStorm™ Premium Soaker Hose

Constructed with a unique design that provides deep, thorough watering for your grass and flowers while using 90% less water. This handy hose is constructed of high-grade rubber with 50% thicker walls that eliminate the "geyser effect", saving water waste, and helping to reduce evaporation. Crush-proof, nickel-plated couplings provide a leak-proof connection.



Item #	Desc	UPC	Vendor	CS/UOS	Location
80170057	1/2"x25'	036434170514	1017051	6/6	East
80170054	5/8"x50'	036434170101	10-17010	6/6	West

Tripod Impulse Sprinkler

The Tripod Impulse Sprinkler stands at 5 feet in height and features a brass impulse sprinkler head for adjustable partial and full-circle patterns, waters an area up to 70 feet in diameter. The retractable stake base design secures the tripod in place while you customize the height and spray area coverage. The overhead watering simulates natural rain to quickly and evenly distribute a gentle, soaking shower. Available carded and in an eye-catching blue color.



Item #	Desc	UPC	Vendor	CS/UOS	Location
80170265	Blue Tripod Sprinkler	036434151056	15105	1/1	West



QAV Shut-Off Valve (A)

Provides fingertip water control with large ergonomic handle made from high grade black ABS plastic. Made in the USA.

Item #	Desc	UPC	Vendor	CS/UOS	Location
80170233	6"x4"x2"	036434223180	60-22318	6/6	West

Heavy Duty Plastic Shut-Off Valve (B)

The 74 Shut-off valve is made from glass filled polypropylene to be very durable and corrosion resistant. More durable than other plastic valves, the 74 is lightweight and offers a full flow. Made in the USA.

Item #	Desc	UPC	Vendor	CS/UOS	Location
80170197	4"x2"x2"	036434227324	60-22732	6/6	National

Brass Shut-Off Valve (C)

Best shut-off valve available. Dramm's #300 Brass Shut-Off Valve provides fingertip water control at the end of your greenhouse hose. A quarter turn of the large ergonomic handle and the water is off. Full water flow design. Made from brass, durable seals and a hard chrome plated ball to provide years of service. 3/4 threads.

Item #	Desc	UPC	Vendor	CS/UOS	Location
80170183	2"x2"x3"	036434123534	60-12353	6/6	National

Aluminum Shut-Off Valve (D)

Light weight, durable, full flow. The Aluminum shut off offers durability in a light weight package. Identical to our #300 brass shut off in design and operation, we have manufactured the body from lighter weight aluminum.

Item #	Desc	UPC	Vendor	CS/UOS	Location
80170192	4"x2"x2"	036434223739	60-22373	6/6	National

DRAMM

5-Liter Watering Can

Superior design and balance made from high-grade injection molded plastic.

Consumer lifetime guarantee. Assorted colors in red, orange, yellow, green, blue & berry. Made in the USA.



Item #	Desc	UPC	Vendor	CS/UOS	Location
80170169	5 Liter	036434124502	60-12450	6/6	National



7-Liter Watering Can

Superior design. High-grade, injection molded plastic with plastic rosette. Lifetime guarantee. 6 bright colors. Made in the USA.

Item #	Desc	UPC	Vendor	CS/UOS	Location
80170167	7 Liter	036434124304	60-12430	6/6	National



2-Liter Watering Can

Superior design and balance made from high-grade injection molded plastic. Consumer lifetime guarantee. Assorted colors in red, orange, yellow, green, blue & berry. Made in the USA.

Item #	Desc	UPC	Vendor	CS/UOS	Location
80170168	2 Liter	036434124403	60-12440	6/6	National

Syphonject with 170PL Nozzle

Water and fertilize at the same time. The Dramm Syphonject Siphon Mixer with External Check Valve draws a concentrated solution from a bucket through a flexible suction tube. For best results use a garden hose no longer than 50 feet and use Dramm's 170 Water Breaker, already included.



Item #	Desc	UPC	Vendor	CS/UOS	Location
80170193	Syphonject	036434226266	6022626	6/6	National



Fogg-It Nozzle (A)

The Fogg-It Nozzle Fine is designed for misting delicate seedlings or for raising humidity around wilting plants. This nozzle has three mist jets, which output one gallon of water per minute.

Item #	Desc	UPC	Vendor	CS/UOS	Location
80170178	Carded	036434123442	6012344	6/6	West

Seedling Nozzle - Brass (B)

The Seedling Nozzle allows you to water fragile plants, delicate seedlings or plant cuttings. This high-quality nozzle sprays 1/2 gallon of water per minute as a cone mist. Made in the U.S.A. from solid brass.

Item #	Desc	UPC	Vendor	CS/UOS	Location
80170181	Carded	036434123503	6012350	6/6	West

Jet Wash Nozzle - Brass (C)

The Jet Wash Nozzle sprays a straight, powerful stream of water. Perfect for cleaning walkways, patios and gutters! Made of durable brass, this nozzle is designed for years of service.

Item #	Desc	UPC	Vendor	CS/UOS	Location
80170188		036434223104	6022310	6/6	West

Sweeper Nozzle (D)

The Sweeper Nozzle sprays a flat, fan-like pattern of water for use in washing surfaces with a sweeping motion. Made of durable brass, this nozzle is designed for years of service.

Item #	Desc	UPC	Vendor	CS/UOS	Location
80170189		036434223111	6022311	6/6	West





Poly Trigger Nozzle (A)

A good hose nozzle is a staple of every gardener's toolbox. Gilmour models provide just the spray pattern you need. Select a specially designed nozzle for unique applications.

Item #	Desc	UPC	Vendor	CS/UOS	Location
80150034	424	034411004746	804742-1001	12/12	National

Insulated Threaded Front Nozzle (E)

Insulated pistol-grip handle for hot or cold water. Solid brass valve stem. Hold-open clip for continuous spraying. Male-threaded head allows attachment of accessories. Stainless steel spring won't rust.

Item #	Desc	UPC	Vendor	CS/UOS	Location
80150038	571TFR	034411057117	857102-1011	1/12	West

Classic Full Metal Nozzle (B)

Heavy duty full size chrome plated zinc body, insulated molded grip for spraying hot or cold water, ideal for commercial or industrial use, brass head insert for maximum resistance to extremely hot water, solid brass valve stem with permanent adjusting nut, hold-open clip for continuous spraying, rust resistant stainless steel spring, self-adjusting "duck" packing for lifetime leakproof seal, male hose threaded front for attaching accessories, rubber head guard to protect threads.

Item #	Desc	UPC	Vendor	CS/UOS	Location
80150360	572TFR	034411057216	805722-1011	12/12	West

Master Rear Trigger Pistol Nozzle (F)

The Gilmour brand exists to meet the needs of gardeners and home owners who demand the very best for their lawns and gardens. With over 100 years of lawn and garden service, Gilmour is proud of its heritage rooted in quality, innovation, and value.

Item #	Desc	UPC	Vendor	CS/UOS	Location
80150265	210GCR	034411028063	821022-1002	6/6	West

Full Size Metal Nozzle (C)

Solid brass valve stem with permanent adjusting nut. Hold-open clip for continuous spraying. Rust resistant stainless steel spring. Self-adjusting "duck" packing for the ultimate leak proof seal. Heavy-duty, mid-size, die cast zinc body.

Item #	Desc	UPC	Vendor	CS/UOS	Location
80150040	573TF	034411057315	857302-1011	12/12	National

Comfort Grip Nozzle W/ Threaded Front (D)

Molded on, black vinyl grip for cushioned comfort. Male hose threaded front for attaching accessories. Solid brass valve stem with permanent adjusting nut. Hold-open clip for continuous spraying. Rust resistant stainless steel spring. Self-adjusting "duck" packing for lifetime leak proof seal. Heavy-duty, full size, die cast zinc body.

Item #	Desc	UPC	Vendor	CS/UOS	Location
80150043	593	034411262733	805932-1011	12/12	National



Swivel Connect Adjustable Nozzle

The Gilmour Control Watering Nozzle with Swivel Connect provides the most comfortable nozzle experience available, with 8 pre-set patterns to cover every watering need. Its Swivel Connect coupling pivots without twisting the hose, reducing kinks by 70%, and it provides a 50% reduction in torque, making it much easier to pull around the yard while keeping the hose straight.

Item #	Desc	UPC	Vendor	CS/UOS	Location
80151124	Front Trigger	034411262733	825602-1001	12/12	West
80151126	Rear Trigger	034411262658	825202-1001	12/12	West
80151125	Thumb Trigger	034411262696	825402-1001	12/12	West

Jet Water Nozzle

Sprays a concentrated jet stream. Attaches to threaded front nozzles or hose end. Not recommended for hot water over 140 degrees. Impact resistant, rustproof polymer construction.



Item #	Desc	UPC	Vendor	CS/UOS	Location
80150339	Plastic Nozzle	034411000069	806032-1001	12/12	West

Brass Solid Water Jet Nozzle

This classic straight nozzle features durable brass construction and easily attaches to threaded-front nozzles or the end of a hose for added cleaning power.



Item #	Desc	UPC	Vendor	CS/UOS	Location
80150340	Brass Jet	034411000618	806002-1001	12/12	West

Adjustable Twist Nozzle

Perfect for watering the garden or general cleanup, the Gilmour Solid Brass Garden Hose Spray Nozzle is made from heavy-duty brass. Four large openings at nozzle head allow for full flow with a precise tip angle that eliminates side spray. Adjustable from a fine spray to a needle stream to a heavy stream.



Item #	Desc	UPC	Vendor	CS/UOS	Location
80150345	528T Brass	034411125281	852812-1001	12/12	West
80150342	529 Rubber Grip	034411005293	805292-1001	12/12	West



Pro Pre-Set Shower Wand

The Gilmour Pro Swivel Connect Wand is built to tackle the most demanding watering jobs and withstand year after year of professional use. Solid metal construction offers superior durability and quality, and a fixed shower spray pattern provides extended reach and optimal water flow.

Item #	Desc	UPC	Vendor	CS/UOS	Location
80151249	Wand	034411262030	820812-1001	6/6	West

Twist Nozzle w/ Rubber Grip

Solid brass construction. All brass valve stem. Four large openings at nozzle tip for full flow. Replaceable front and rear O-ring seals for leakproof shut-off. Precise tip angle eliminates side spray. Adjustable from fine spray to needle stream to heavy rinse.



Item #	Desc	UPC	Vendor	CS/UOS	Location
80150036	Twist Nozzle	034411005286	805282-1001	12/12	West

Power Flow Nozzle

Professional Twist Nozzle - your high-performance partner for all professional-grade cleaning and watering needs. This all-metal bodied, robust tool is designed to deliver unparalleled durability and comfort during extended use. It features an adjustable head that allows you to regulate the water flow from a concentrated stream to a gentle mist, perfect for a variety of tasks.



Item #	Desc	UPC	Vendor	CS/UOS	Location
80150344	Power Flow Nozzle	034411114001	840182-1001	8/8	West

Fire Hose Nozzle

Large comfort grip provides a secure hold. All-in-one, fireman-style handle controls water flow & on/off function. Water stream adjusts from jet to gentle rinse.



Item #	Desc	UPC	Vendor	CS/UOS	Location
80150346	Fire Hose Nozzle	034411126417	810022-1001	6/6	National

Select-A-Spray Nozzle

Five-position dial with seven spray patterns: gentle shower, full action (cone, sharp stream, full flow), jet, mist and flood. Hold open clip for continuous spraying. Rust-resistant stainless steel spring. Self-adjusting "duck" packing for lifetime leakproof seal.



Item #	Desc	UPC	Vendor	CS/UOS	Location
80150042	Poly	034411005866	805862-1001	10/10	National
80150041	Zinc	034411005842	805842-1001	10/10	National
80150044	Zinc/Comfort Grip	034411005941	805942-1001	10/10	West



Zinc Coupler (A)

Premium construction for maximum strength and durability. Reusable and leakproof. Non-corroding, high-grade stainless steel screws will not strip when tightened. For use with plastic or rubber hose. Fits all 5/8"-3/4" ID hoses.

Item #	Desc	UPC	Vendor	CS/UOS	Location
80150002	5/8"-3/4" Female	0334411001653	801014-1001	12/12	National

Plastic Hose Mender (B)

Premium construction for maximum strength and durability. Reusable and leakproof. Non-corroding, high-grade stainless steel screws will not strip when tightened. For use with plastic or rubber hose.

Item #	Desc	UPC	Vendor	CS/UOS	Location
80150003	5/8"-3/4"	034411000014	801024-1002	12/12	National
80150011	1/2"	034411000052	805044-1001	12/12	National

Plastic Coupler (C)

Premium nylon construction for maximum strength and durability. Reusable and leakproof. Non-corroding, high-grade stainless steel screws will not strip when tightened. For use with plastic or rubber hose.

Item #	Desc	UPC	Vendor	CS/UOS	Location
80150010	1/2" Female	034411000526	805004-1002	12/12	National
80150012	1/2" Male	034411000519	805054-1002	12/12	National
80150001	5/8"-3/4" Female	034411000120	801004-1002	12/12	National
80150005	5/8"-3/4" Male	034411000113	801134-1002	12/12	National

Full Flow Water Shut-off Valve (D)

Impact resistant, rust proof polymer construction stands up to frequent use and allows 45% more flow than standard valves, so you can connect up to an accessory without decreasing water volume.

Item #	Desc	UPC	Vendor	CS/UOS	Location
97-63252	Plastic	034411205228	800014-1001	6/6	National

Full Flow Double Hose Shutoff "Y" Connector (E)

Durable metal construction stands up to frequent use and allows more flow than standard valves, so you can connect up to two hoses with optimal water volume delivery.

Item #	Desc	UPC	Vendor	CS/UOS	Location
80150571	Metal	034411261392	800024-1001	6/6	East

Y Shut-Off Connector (F)

Twin shut-off valves control water flow for two hoses. Cap type valve handles resist breakage. Longer legs prevent hose kinks at faucet. Full ball and retainer rings reduce leakage, even at low pressure.

Item #	Desc	UPC	Vendor	CS/UOS	Location
80150025	Brass	034411007136	813004-1001	6/6	National
80150027	Plastic	034411000175	800174-1002	12/12	National



Brass Clamp Coupling

Don't let a crushed coupling take your hose out of commission. Replace damaged female or male hose ends with a heavy-duty brass and zinc coupling that offers superior durability for active job sites. Non-corroding stainless steel screws won't strip when tightened onto your hose. Fits 5/8" & 3/4"

Item #	Desc	UPC	Vendor	CS/UOS	Location
80150517	Female	034411029756	801014-1003	6/6	West
80151326	Male	034411029749	801324-1001	12/12	West
80151324	Coupling	034411029817	801124-1003	12/12	West

Shut-Off Valves

Shut-off valve controls water flow; saves water and time. Cap type valve handle resists breakage.



Item #	Desc	UPC	Vendor	CS/UOS	Location
80150008	Brass	034411007037	803004-1001	6/6	National
80150013	Zinc	034411000038	805084-1001	12/12	West
80150014	Plastic	034411000076	807004-1002	12/12	National



Brass Clamp

Heavy Duty 5/8" Brass Clamp

Item #	Desc	UPC	Vendor	CS/UOS	Location
80151217	Female 5/8"	034411261385	871554-1001	12/12	West
80151215	Male 5/8"	034411261354	871524-1001	12/12	West
80151216	Mender 5/8"	034411261378	871534-1001	12/12	West

Plastic Shut-Off Valve

The Ir nelson rezimar outlet hose adapter features a rezimar body with a metal swivel Coupling.



Item #	Desc	UPC	Vendor	CS/UOS	Location
80151234	Single Shut-Off	077855806194	850304-1001	10/10	West
80151236	Double Shut-Off	077855806231	853104-1001	10/10	West

Pro Brass Quick Connector Set

Brass Heavy-duty Quick Connect provides an easy snap-on/snap-off connection to make tasks on the jobsite easier. Simply attach the female connector to the end of your hose and the male connector to your sprinkler, nozzle or second hose.



Item #	Desc	UPC	Vendor	CS/UOS	Location
80150515	Quick Connect	034411029824	840204-1001	12/12	National

High Flow Plastic Quad Shut-Off Valve

Complement your lawn watering products with accessories designed to maximize their utility. The high flow 4-outlet Manifold faucet adaptor has a rezimar body with metal ergo swivel Coupling. The 4 outlets are ideal for use with drip systems.



Item #	Desc	UPC	Vendor	CS/UOS	Location
80151240	Quad Shut-Off	077855807979	853164-1001	8/8	West

Metal Dual Shut-Off Valve

Twin shut-off valves control water flow for two hoses. Cap type valve handles resist breakage. Longer legs prevent hose kinks at faucet. Full ball and retainer rings reduce leakage, even at low pressure. No. 17 non-corroding, high impact poly construction. Not recommended for hot water. No. 15 chrome-plated zinc construction. Withstands hot water temperatures to 160 deg F.



Item #	Desc	UPC	Vendor	CS/UOS	Location
80151389	Dual Metal Shutoff	034411000151	800154-1001	6/6	West

Heavy Duty Quick Connector

Heavy-duty Quick Connectors provide an easy snap-on/snap-off connection between your hose and other watering tools. Simply attach the male connector to your sprinkler, nozzle or second hose. Then connect to a heavy duty female quick connector at the end of your hose for a tight seal that lasts.



Item #	Desc	UPC	Vendor	CS/UOS	Location
80150747	Male	34411261330	871514-1001	12/12	East
80150514	Male #400	034411029800	800094-1003	12/12	East
80150748	Female	34411261392	871554-1001	12/12	East

Cleaning Sprayer Foamaster

Ideal for safely mixing and spraying foaming chemicals. Features a quick-set dial for selecting a mixing ratio, so your cleaning solution will be accurate the first time.



Item #	Desc	UPC	Vendor	CS/UOS	Location
80151134	1/2 Gal	034411167533	875054-1001	6/6	West

Heavy Duty 1-Way Valve

This valve allows you to switch tools with ease all while staying dry. Features all-metal construction with brass threads and is rust-resistant even with frequent use. The durable, easy-grip handle makes it simple to attach to tools. Easily stop the flow of water with its easy-to-use on/off switch.



Item #	Desc	UPC	Vendor	CS/UOS	Location
80150750	1-Way Valve	034411261262	871104-1001	30/30	West

High Flow Brass Dual Outlet Shut-Off Valve

Upgrade your watering setup with the Gilmour Pro High Flow Brass Dual Outlet Shut-Off Valve. This premium dual outlet valve allows you to connect two hoses and control water flow individually with ease. Crafted from high-quality brass, it offers superior durability and corrosion resistance, making it perfect for outdoor use.



Item #	Desc	UPC	Vendor	CS/UOS	Location
80151391	Pro Brass High-flow	034411029794	813024-1002	6/6	West

Brass 4-Way Connector

Four way shut-off valve controls water flow. Extra large handles for easy grip and turn. Easy-on swivel connector prevents hose kinks by allowing hose to turn. Withstands hot water temperatures. Heavy-duty brass construction.



Item #	Desc	UPC	Vendor	CS/UOS	Location
80150575	Brass 4-Way	034411210444	800444-1001	8/8	West

Heavy Duty 2-Way Valve

Efficiently water more of your lawn at once with the heavy duty dual shut-off valve. Featuring all-metal construction with brass threads, This rust-resistant valve stands up to frequent use. The durable, easy-grip handle makes it simple to connect up to two hoses at once.



Item #	Desc	UPC	Vendor	CS/UOS	Location
80150751	2-Way Full flow Heavy Duty	034411261286	871204-1001	24/24	West

Heavy Duty 4-Way Valve

Efficiently water up to four different areas of your lawn or garden at once with the heavy duty quad shut-off valve. Featuring solid metal construction with brass threads, This rust-resistant valve stands up to frequent use. The durable, easy-grip handle makes it simple to connect up to four hoses at once.



Item #	Desc	UPC	Vendor	CS/UOS	Location
80150752	Metal Full flow Shut off Valve Quad	034411261309	871404-1001	6/6	West

Aluminum Shut-Off Valve

More performance from sprinklers and nozzles. Single shut-off valve controls water flow. Extra-large handles for easy grip and turn. Easy-on swivel connector. Withstands hot water temperatures.



Item #	Desc	UPC	Vendor	CS/UOS	Location
80150191	1-Way Aluminum	034411205150	801074-1001	6/6	West

Full Flow Aluminum 2-Way Connector

Durable metal construction stands up to frequent use and allows more flow than standard valves to increase watering efficiency. Connect up to four hoses to water multiple areas of your yard at once.



Item #	Desc	UPC	Vendor	CS/UOS	Location
80150568	2-Way Aluminum	034411205167	800214-1001	6/6	West

Full Flow Aluminum 4-Way Connector

This Gilmour Full Flow metal hose manifold features 4 ports with shutoff valves and 1 side connections to attach additional water hoses. The Full Flow Features allows for 45% more water flow compared to standard fixtures. For multiple watering uses garden hose, this bib hose valve is a great accessory to have on hand.



Item #	Desc	UPC	Vendor	CS/UOS	Location
80150569	4-Way Aluminum	034411205174	800404-1001	6/6	West

Medium Duty Hose

Lightweight, yet durable easy to maneuver around your outdoor spaces for routine watering and cleaning.



Item #	Desc	UPC	Vendor	CS/UOS	Location
80151280	5/8" X 25'	034411603185	816251-1014	10/10	National
80151281	5/8" X 50'	034411030103	816501-1014	6/6	National
80151282	5/8" X 75'	034411030110	816751-1014	4/4	National
80151278	5/8" X 100'	046561006679	816001-1014	2/2	National

Round Soaker Hose

Ideal for new plantings, shrubs, bushes and raised beds, the soaker hose releases water from a flexible, vinyl hose directly into the soil. Water without waste by delivering a steady stream no faster than the ground can absorb it, deep into the soil-not pooling on top of it.



Item #	Desc	UPC	Vendor	CS/UOS	Location
80151291	5/8" X 25'	034411927748	827251-1005	6/6	West
80151292	5/8" X 50'	034411927755	827501-1005	6/6	West

Tube Sprinkler Hose

Water narrow, curved or irregular patches of lawn with this 2-in-1 sprinkler and soaker hose. A low spray releases water at a consistent, controlled rate – perfect for new grass.



Item #	Desc	UPC	Vendor	CS/UOS	Location
80151290	50'	034411261231	871421-1004	10/10	National

Flexogen® Super Duty Hose

Exceptionally rugged, abrasion-resistant with a polished surface that stays clean and resists scuffing and stains. 8-ply construction - 500 PSI burst strength. Double tire cord reinforced for strength, yet is lightweight and coils and handles easily. Kink resistant. Heavy-duty, crush resistant, Full-Flo machined metal couplings with built in washer for tight sealing.



Item #	Desc	UPC	Vendor	CS/UOS	Location
80151159	5/8" X 25'	034411742518	874251-1003	6/6	West
80150022	5/8" X 50'	034411112038	874501-1021	6/6	National
80151285	5/8" X 75'	034411745014	874751-1004	4/4	National
80150024	5/8" X 100'	034411112052	874001-1021	2/2	East
80151180	5/8" X 100'	034411740019	874001-1021	1/1	West

Marine & Recreation Hose

Outstanding durability and flexibility make it perfect for year-round use. With non-marring blue-striped white cover, Full-Flo® brass couplings and EZ-on coupler. Blue protective collar on 5/8".



Item #	Desc	UPC	Vendor	CS/UOS	Location
80151294	5/8" X 50'	034411263617	894501-1003	6/6	West

Flexogen® Heavy Duty Hose

The strongest, lightest hose in its class, Flexogen delivers superior all around performance for your lawn, garden, deck and driveway. The hose features a patented 8-layer construction with reinforced core to maximize durability. Count on a Flexogen garden hose to curve without kinking, connect without leaking and hold up season upon season.



Item #	Desc	UPC	Vendor	CS/UOS	Location
80151169	3/4" X 25'	034411112069	843251-1003	5/5	National
80151170	3/4" X 50'	034411112076	843501-1003	4/4	National
80151171	3/4" X 75'	034411112083	843751-1003	2/2	National
80151168	3/4" X 100'	034411112090	843001-1002	1/1	National
80151173	5/8" X 25'	034411642511	864251-1016	6/6	National
80151174	5/8" X 50'	034411645017	864501-1021	6/6	National
80151175	5/8" X 75'	034411647516	864751-1017	4/4	National
80151172	5/8" X 100'	034411261057	864001-1020	2/2	National

Kink Protector

Prevents kinking at faucet. Coiled spring faucet extension with solid brass couplings. Protects hose. Allows hose to bend at sharp angle and maintain even water flow.



Item #	Desc	UPC	Vendor	CS/UOS	Location
80150526	Kink Protector	034411010822	810054-1001	12/12	West

Steel Hose Hanger

Holds 50' to 150' of hose.
Easy hose storage over faucet.



Item #	Desc	UPC	Vendor	CS/UOS	Location
80150206	Steel	034411081150	881154-1001	12/12	National

Aluminum Hose Hanger

Durable, corrosion-resistant aluminum.
Keyhole design for easy installation.



Item #	Desc	UPC	Vendor	CS/UOS	Location
80150207	Aluminum	034411082157	882154-1001	12/12	National

8015 Hose Hanger

Durable polymer construction.
Includes storage rack for nozzles,
sprayers or gloves.



Item #	Desc	UPC	Vendor	CS/UOS	Location
80150208	Polymer	034411080153	880154-1001	12/12	National

Faucet Hose Extender

The heavy-duty Gilmour faucet watering hose extender allows you to extend your faucet past plants and bushes. It boasts 500 PSI burst strength, heavy-duty metal couplings, and an impact-resistant spike to hold the hose faucet securely. Measuring 6' in length, it is designed for hoses 5/8" in diameter. This product is backed by a lifetime warranty.



Item #	Desc	UPC	Vendor	CS/UOS	Location
80150049	Faucet Extender	034411010761	800604-1005	10/10	National

Telescoping High Rise Garden Sprinkler

Adjustable aluminum pole telescopes from 24" to 40". Metal screen filter prevents clogging. Impact resistant, rustproof polymer head and spike. Square pattern coverage up to 50'.



Item #	Desc	UPC	Vendor	CS/UOS	Location
80150048	894	0034411108963	808963-1001	6/6	West



Spot Sprinkler

Targeted watering with superior durability. Gentle, fountain-like spray is ideal for spot-watering small areas without waste. Perfect for treating trouble spots on the lawn and new seed.

Item #	Desc	UPC	Vendor	CS/UOS	Location
80150430	A Circle Water Pattern	034411087633	808763-1001	10/10	West
80150428	B Square Water Pattern	034411087619	887613-1001	10/10	West
80150429	C Rectangle Spray Pattern	034411087626	887603-1001	10/10	West

Oscillating Sprinkler

This adjustable length oscillating sprinkler provides the easiest and most familiar approach to watering your lawn. Simply turn the dial to select area to water. This sprinkler features an improved motor for added life and an ABS base for increased durability.



Item #	Desc	UPC	Vendor	CS/UOS	Location
80150731	Plastic 3,600 sq. ft.	034411800133	880013-1011	6/6	National

Aluminum Bubbler Sprinkler

The Gilmour Aluminum Bubbler Sprinkler is designed with precision in mind, ensuring that water is distributed exactly where it's needed most. Crafted from high-quality aluminum, this sprinkler is built to withstand the test of time. Its corrosion-resistant properties make it ideal.



Item #	Desc	UPC	Vendor	CS/UOS	Location
80150427	Aluminum Bubbler	034411031575	831503-1001	12/12	West

Triple Spike Sprinkler

Provides full or partial coverage. Patented impulse arm saves water by eliminating back and side splash. Diffuser screw allows for easy fingertip adjustment of water stream for even coverage. Water coverage up to 86' diameter at 30 PSI; 112' diameter at 60 PSI.



Item #	Desc	UPC	Vendor	CS/UOS	Location
80150396	Poly	034411028445	822003-1011	6/6	East

Metal Impulse Sprinkler with Adjustable Tripod Base

Metal impulse sprinkler provides full or partial coverage up to 5800 sq. ft., standing up to 56in. tall on a telescoping tripod stand. Color: Gray steel, Adjustable: Yes, Coverage Diameter (ft.): 86, Sprinkler Radius (ft.): 43, Sprayer Type: Impulse, Material: Metal, Sprinkler Coverage (sq. ft.): 5,800



Item #	Desc	UPC	Vendor	CS/UOS	Location
80150441	5,800 sq.ft.	34411011737	819003-1001	1/1	National

Oscillating Sprinkler w/ Turbo Motor

Additional coverage for larger area. Dial easily allows user to set their spray area: left, right, center, full. Provides a gentle spray for delicate plants & re-seeding yd. Swivel coupling makes it easy to attach to hose.



Item #	Desc	UPC	Vendor	CS/UOS	Location
80150768	3000 sq. ft	034411188453	888303-1012	4/4	National

Sprinkler

Through innovative design & technology Gilmour created a sprinkler that's easy to use, simple to adjust & intuitively customizes to fit your lawn. Gilmour clever on-off flow control switch requires just one simple turn to move from on to off & every pt. In between. That means no more getting soaked when you want to move your sprinkler.



Item #	Desc	UPC	Vendor	CS/UOS	Location
80150734	Oscillating	034411260531	883023-1011	6/6	West
80150769	Rectangular	034411260524	883013-1011	6/6	West

Ring Base Sprinkler

Works well in low water pressure areas Featuring metal construction, this lawn sprinkler head is durable to provide many years of dependable yard watering. It has a unique design that ensures no water puddling.



Item #	Desc	UPC	Vendor	CS/UOS	Location
80150426	900 sq. ft.	034411030615	830603-1001	12/12	West

Heavy Duty Circular Sprinkler

Versatility of this 8-pattern sprinkler makes watering different shaped areas of your yd. a breeze. Durable construction withstands everyday use & guarantees lasting performance. Designed to operate with low water pressure & is ideal for small lawns or gardens.



Item #	Desc	UPC	Vendor	CS/UOS	Location
80151315	8 pattern	034411806036	859563-1014	6/6	West

Pattern Master Circular Sprinkler

Customize your sprinkler's spray and never over-water again. Create your own spray pattern to fit any irregularly shaped area of lawn. Flexible ring customizes spray distance at 12 different points for the ultimate in precise watering.



Item #	Desc	UPC	Vendor	CS/UOS	Location
80150446	86-feet	034411011966	819603-1011	6/6	West

Turbine Rotor Sprinkler

Durable, rustproof polymer sled base. Easily adjusted to cover a full or partial circle. Multi-stream nozzle provides even coverage. Water coverage up to a 4000 sq-ft. (70 ft circle). Sliding deflector for distance control.



Item #	Desc	UPC	Vendor	CS/UOS	Location
80150419	200SPB	034411020029	820133-1001	6/6	West

Metal Square Pattern Rotary Sprinkler

Gilmour Square Pattern Rotary Sprinkler This all metal sprinkler has a weighted base with wheels and 3 sprinkler arms. It will water a square area up to 45 feet by 45 feet. Water coverage up to 2100 square feet.



Item #	Desc	UPC	Vendor	CS/UOS	Location
80150544	45-feet	034411003404	845003-1002	6/6	West

Full Flow Poly 4-Way Connector

The Gilmour Quad Full-flow Shut-off Valve is made of impact-resistant, rust-proof polymer to stand up to frequent use, and it provides more flow than standard valves for watering efficiency. An easy-turn knob at each of the four valves allows for quick on/off operation of up to four hoses, and a swivel coupling offers a tight, secure connection to the spigot.



Item #	Desc	UPC	Vendor	CS/UOS	Location
80150572	Full flow Shut off Valve Quad	034411205242	800414-1001	6/6	West

Hose Thread End Cap

These hose caps are for use with 3/4 inch standard hoses. These caps also come with a hose washer. They are made with a durable and rust-proof polymer.



Item #	Desc	UPC	Vendor	CS/UOS	Location
80150581	3/4"	034411000403	800044-1001	12/12	West

Brass Coupler Washers

Quick Connectors link watering tools in one snap; maintain that connection with replacement seals. Durable rubber construction keeps the seal strong, even with frequent use.



Item #	Desc	UPC	Vendor	CS/UOS	Location
80150159	Pro Seals for Brass Quick Connector (3PC)	034411000984	809104-1001	10/10	East

Hose Coupling Filter Washers

Molded-in metal screen. Fits all hose couplings.



Item #	Desc	UPC	Vendor	CS/UOS	Location
80150184	3 pack	034411027103	802004-1001	12/12	National

Replacement Hose Seals

Ensure that your professional-grade Flexogen hose is ready for the toughest jobs with durable replacement seals. Simply remove your current seal pop in a new one and enjoy a tighter leak-free connection to your spigot or watering accessories.



Item #	Desc	UPC	Vendor	CS/UOS	Location
80151214	Pro Replacement Hose Seals (6PC)	034411000106	870014-1001	20/20	West

Vinyl Hose Washers

Replacement seals for 09QC brass quick connectors. Heavy-duty rubber construction. 10 pack.



Item #	Desc	UPC	Vendor	CS/UOS	Location
80150166	5/8"-3/4"	034411000229	801154-1001	10/1	East

Rubber Hose Washers

Rubber Hose Seals. Heavy-duty rubber construction. 10 pack.



Item #	Desc	UPC	Vendor	CS/UOS	Location
80150007	5/8"-3/4"	034411025888	801704-1003	12/1	East

Mechanical Timer

Simply set the amount of time you want your hose or sprinkler to run, switch to "On" and let this timer take care of the rest. Automatically shuts water off when you want it to, no batteries required.



Item #	Desc	UPC	Vendor	CS/UOS	Location
80150473	Timer	034411027981	820054-1001	6/6	National

Electronic Single Outlet Timer

The Gilmour single outlet electronic timer is easy to set and use, no tools needed, and it automatically turns water on and off. Run time is from 1 to 360 minutes (6 Hours), has a rain delay feature and has a large easy to read LCD display. If batteries are low the valve closes and will not open. 2 AA batteries required (not included).



Item #	Desc	UPC	Vendor	CS/UOS	Location
80150474	Timer	034411028001	830134-1001	3/3	National

Electronic Dual Outlet Water Timer

This double outlet Gilmour Electronic Water Timer has an easy-to-set dial and large LCD screen that make programming water start, stop and run time easy, up to 360 minutes. It also has a manual on/off button for additional flexibility. The rain delay feature lets you skip watering when it rains.



Item #	Desc	UPC	Vendor	CS/UOS	Location
80150475	Timer	034411028018	804014-1001	3/3	National



Leader in Horticultural Containers

1-Quart Green Watering Can

Special features include an ergonomic handle and balanced design to make this everyday gardening tool versatile, easy-to-use, and durable. Large, offset opening is easy-to-fill from spigot or sink. Long, drip-resistant spout. Molded-in water-level indicators to make it easy to determine proper water-to-fertilizer ratio.



Item #	Desc	UPC	Vendor	CS/UOS	Location
80280829	1 qt	032903075588	RZ.WC1Q0B91	6/6	National

2-Gallon Green Watering Can

Premium watering can crafted for effortless filling from a spigot or sink to assist you in helping your plants and flowers thrive. Offset design with a rosette allows you to pour without the worry of spilling from the watering can mouth.



Item #	Desc	UPC	Vendor	CS/UOS	Location
80280830	2 gal	032903725186	RZ.WC2G0B91	8/8	National

2 Gallon Green Standard Watering Can

The 2 Gallon Green Standard Watering Can has an ergonomic handle with a balanced design that is easy-to-use and durable. The large offset opening is easy to fill from the spigot or sink. It has a long, drip-resistant spout with molded-in water level indicators that make it easy to determine proper water-to-fertilizer ratio.



Item #	Desc	UPC	Vendor	CS/UOS	Location
80282486	2 gal.	770932840899	RZ.WC2G3B66	10/10	National



Essential Watering Can

Lightweight plastic indoor watering can with large opening for easy filling. Fun and fashionable color so it can be displayed as part of your decor or hidden away in a cupboard.



Item #	Desc	UPC	Vendor	CS/UOS	Location
80282877	1/2 gal Watermelon	770932844897	RZ.WCHG0FD7	24/24	National

1-Gallon Green Watering Can

Fill opening is to the side of the can, allowing for easy filling from sink or spigot. Long, drip-resistant spout. Molded in water level indicators on the side, with volume measured in both gallons and liters, useful in determining proper water-to-fertilizer ratio.



Item #	Desc	UPC	Vendor	CS/UOS	Location
80290075	1 gal	032903728866	RZ.WC1G0B91	6/6	National



Vinegar 360 Degree All Angle Power Sprayer

360 4 finger sprayer can spray at all angles (including upside down) without leaking. Adjustable nozzle from a fine mist to a solid stream, the sprayer can be easily adjusted to suit your needs. Pressurized by automatically reloading after every use, preventing you from having to squeeze multiple times to prime. Once measurements are listed on the bottle.



Item #	Desc	UPC	Vendor	CS/UOS	Location
82770119	32 fl. oz.	072725015010	VIN-32S	12/12	National

360 Upside Down Powder Sprayer

Sprayer everyone has been waiting for. It will spray in any angle, including upside down, without losing pressure. It holds up to 32 Oz. of liquid and is used by professionals and homeowners in commercial, industrial and household environments. The bottle and trigger sprayer are made of heavy duty polyethylene and are recyclable. The level of contents is clearly visible through the clear plastic bottle.



Item #	Desc	UPC	Vendor	CS/UOS	Location
82770001	32 fl. oz.	072725004618	360-32S	12/12	National



Hose Bib Extender

Yard Butler's garden hose connector keeps your hose where you need it most. Stop dragging your garden hose reel cart across your prized plantings or freshly mowed lawn. The outdoor faucet extension lets you place your spigot where it's most convenient. No more squeezing between bushes or winding around corners. Install in just minutes without a plumber or equipment unless you want to plumb to in-ground PVC or a copper system.



Item #	Desc	UPC	Vendor	CS/UOS	Location
80740035	Bib Extender	033607220069	HBE-6	4/4	National

Hose Hanger - Wall Mount

Hanging your hose up off the ground not only keeps your yard tidy, it extends the life of your hose. But there is a big difference between 100 ft of empty garden hose and one filled with water.



Item #	Desc	UPC	Vendor	CS/UOS	Location
80740040	Wall Mount	033607220007	HCWM-1	12/12	National

Ring Base Stand

Create a lush and stunning landscape with the Yard Butler RB-13 1/2" Lawn Sprinkler Stand. Its heavy-duty steel construction ensures your sprinkler will stay securely in place, while its powder-coated finish gives it long-lasting durability you can depend on. Plus, this stand won't tip over, so you don't have to worry about any accidents!



Item #	Desc	UPC	Vendor	CS/UOS	Location
80740062	1/2" Head	033607009756	RB-13	10/10	National

Swivel Reel - Wall Mount

The Yard Butler Wall Mounted Swivel Reel provides a tidy method for safely storing up to 100 feet of 5/8 inch hose. Mounting bolts included. Swivel wall-mount design swings 180 degrees for easy winding and unwinding. Just pull it away from the wall and reel in at any angle. All steel construction with attractive silver-vein powder coat finish that will stand up to years of outdoor use. Supply hose included.



Item #	Desc	UPC	Vendor	CS/UOS	Location
80740050	Swivel Reel	033607225507	SRWM-180	1/1	National

Hose Truck - 2 Wheeled

The 2-Wheeled Hose Cart is built for stability so it won't tip or drag even when you give it a tug. Need to lend it to the neighbor? Easy. It's built to tip back with perfect balance and roll away with ease. storing up to 200 FT 5/8 Hose



Item #	Desc	UPC	Vendor	CS/UOS	Location
80740041	Hose Truck	033607221257	HT-2EZ	1/1	National



MiniMax™ Turbo Oscillating Sprinkler

Get the coverage and adjustability of a full-sized oscillating sprinkler in a compact design. The MiniMax Turbo Oscillating Sprinkler covers up to 4,000 sq. ft. to water large lawns, growing gardens, or newly seeded areas. The adjustable tripod base takes your watering to new heights by easily adjusting up to 39" high, ideal for taller plantings. Avoid wasting water on the driveway or sidewalk with easy adjustments. Change the width and range of the water flow for a small garden or super narrow strip of lawn.

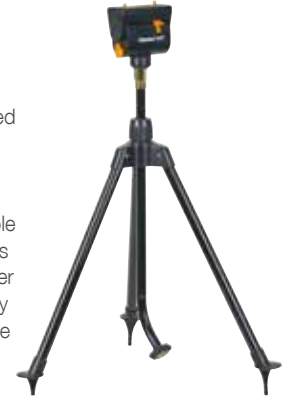

Item #	Desc	UPC	Vendor	CS/UOS	Location
81780031	4way Adjust	042206040602	4060-4	4/4	West
81780033	4way on spike	042206040688	4068	4/4	West

Turbo Oscillating Sprinkler

Get the gentle coverage your lawn needs with the even coverage of the Melnor® Turbo Oscillating Sprinkler. The fully adjustable range control adjusts the motion of the sprinkler tube to control the length of the watering area. Adjust forward, backward, or both to water a long or short area. The dependable Dirt-Resistant Drive provides smooth movements for consistent coverage that will not puddle. The unique system is key for homeowners with well water. It allows water to bypass the gears and continue watering even when grit is present in the water. The durable design is built to last so you can enjoy green grass and beautiful blooms season after season.



Item #	Desc	UPC	Vendor	CS/UOS	Location
81780321	4,000 sq. ft.	042206450005	XT45000	6/6	National
81780322	4,500 sq. ft.	042206451002	XT45100	6/6	National
81780323	4,500 sq. ft. w/ Integrated Timer	042206451101	XT45110	6/6	National



Metal Turbo Oscillating Sprinkler

Whether you want to water the whole yard or a smaller flower bed, get to it with the adjustable coverage of the 4,500 Sq. Ft. Metal Turbo Oscillating Sprinkler with Flow Control. The fully adjustable sprinkler lets you control your watering in three dimensions: width, range, and flow. Keep the water on the lawn and off the driveway with TwinTouch™ controls to set the width and range of the water pattern.



Item #	Desc	UPC	Vendor	CS/UOS	Location
81780326	4,500 sq. ft.	042206452016	XT45200M	6/6	National

Oscillating Sprinkler

The gentle shower of the EasyGrow™ Max Oscillating Sprinkler is perfectly suited for newly seeded gardens or established yards. Covers up to 3,400 sq. ft.



Item #	Desc	UPC	Vendor	CS/UOS	Location
81780028	2,650 sq. ft.	042206402608	20260	12/12	West
81780030	3,400 sq. ft.	042206223005	22300	6/6	West

TURBOTEK™ Oscillating Sprinkler

Melnor® TurboTek™ Turbo Oscillating Sprinklers deliver the smoothest operation for even, gentle coverage. Covers up to 3,200 sq. ft.



Item #	Desc	UPC	Vendor	CS/UOS	Location
81780026	3,200 sq. ft.	042206302618	30261	6/6	National

Metal Pulsating Sprinkler with Tripod

Take watering to new heights with the Metal Pulsating Sprinkler with Tripod. Cover an area up to 85' in diameter, great for watering large size lawns and gardens. The sturdy tripod base extends up to 48" high, to water from above...providing a more natural, rain like spray. The all metal construction is durable enough to last through seasons of use.



Item #	Desc	UPC	Vendor	CS/UOS	Location
81780039	Pulsating Sprinkler Tripod	042206096203	9620-8	4/4	National

Pulsating Sprinkler

Features adjustable control that allows you to select watering distance and coverage angle for your specific needs. Covers up to an 85ft diameter.



Item #	Desc	UPC	Vendor	CS/UOS	Location
81780044	Head w/ Metal Spike	042206955012	9550C	12/12	National
81780041	Head w/ Weighted Base	042206140586	9570	12/12	West
81780045	Dual Pack Head w/ Metal Spike	042206295507	9550DP	6/6	West

Metal Pulsating Sprinkler

For large lawn and garden watering needs, a pulsating sprinkler is hard to beat. The pulsating action of this sprinkler will provide green lawns and bountiful harvests for years to come. Even in hard soils, the sturdy metal step-spike will securely position the sprinkler. 85' Coverage



Item #	Desc	UPC	Vendor	CS/UOS	Location
81780052	Replacement Head	042206095374	9537	6/6	West
81780047	Head w/ Metal Spike	042206145994	9536CH	6/6	West
81780053	Head w/ Weighted Base	042206039002	3900H	6/6	West



Sprout Ring Sprinkler

The perfect little sprinkler to water those tricky spots around the yard. Place in a small garden for easy watering or move to the front yard by a patch of newly seeded lawn. The soft rain-like coverage will nourish plants without damaging delicate flowers or washing away seeds. Trusty Sprout watering tools will keep your lawn and garden healthy for years to come.

Item #	Desc	UPC	Vendor	CS/UOS	Location
81780269	Assorted	042206155771	SP15577	12/12	West

Ring Sprinkler

The gentle spraying action of this sprinkler is ideal for watering small areas. Its small, lightweight design makes it easy to move and place in the yard to water flowers or difficult areas of the lawn.



Item #	Desc	UPC	Vendor	CS/UOS	Location
81780070	900 sq. ft.	042206141033	112	12/12	West



Metal 8-Pattern Sprinkler

The ideal sprinkler for any shaped garden. Each of the eight spray patterns provides a unique water pattern to cover the size area you need. It's perfect for a small flower bed, corner garden, or tricky spot in the yard. The gentle water flow nourishes plants without damaging delicate flowers or washing away newly planted seeds. Trusty Sprout watering tools will keep your lawn and garden healthy for years to come.

Item #	Desc	UPC	Vendor	CS/UOS	Location
81780270	Blueberry Blue	042206156860	SP15686BB	6/6	West
81780271	Gooseberry Green	042206156877	SP15687GG	6/6	West
81780272	Raspberry Red	042206156884	SP15688RR	6/6	West
81780069	Metal Base	042206702692	70269	6/6	West

Metal Square Pattern Sprinkler

Water every corner of the garden with the unique Square Pattern Sprinkler. The clever whirling design creates a unique spray pattern and gentle rain-like coverage. Place around the yard to water the lawn, flower beds, or a vegetable garden without damaging delicate plants or washing away seeds. Built of durable metal, it is designed to last for years to come.



Item #	Desc	UPC	Vendor	CS/UOS	Location
81780060	31 sq. ft.	042206078001	7800	6/6	National

Turbo Rotary Sprinkler with Tripod

Rotary sprinkler with 43" adjustable tripod base, waters up to 80' in diameter. Adjustable head with six patterns. Durable turbo motor that features quiet operation for early morning watering.



Item #	Desc	UPC	Vendor	CS/UOS	Location
81780059	Rotary Sprinkler Tripod	042206157522	15752	6/6	National

Metal Revolving Sprinkler

Easy to use and durable, the 3-Arm Revolving Sprinkler is ideal for watering medium sized lawn areas. Simply attach a standard garden hose and turn on the water. The wheeled base makes the move to the next area easy while the gentle watering action promotes healthy lawn growth.



Item #	Desc	UPC	Vendor	CS/UOS	Location
81780065	3-Arm Rotary w/ Wheeled Base	042206070005	7000	6/6	West

8-Pattern Turret Sprinkler

If your lawn has small irregularly shaped areas that need water, the Melnor 269 sprinkler is perfect. The 8 spray patterns cover everything from circular to square to fan shaped. The tip-resistant base makes it easy to set-up & move.



Item #	Desc	UPC	Vendor	CS/UOS	Location
81780068	8 spray pattern	042206002693	269	12/12	West

Turbo Rotary Sprinkler

The Turbo Drive Rotary Sprinkler is ideal for watering large lawns and gardens. Water early in the morning with a nearly silent operation that won't disturb the neighbors. The unique two-stage watering pattern provides even coverage. The sturdy metal spike works well even in hard soils for easy placement that stays securely in place. Unit-to-unit connection allows multiple sprinklers to connect and water an even larger area. Get great coverage for a green lawn and healthy garden all season long.



Item #	Desc	UPC	Vendor	CS/UOS	Location
81780037	5,000 sq. ft.	042206029508	2950	6/6	West

Xt High Capacity 7-Pattern Torrent

Built extra tough for the professionals, yet designed for everyday use... Torrent is the perfect all-purpose powerful cleaning tool. With a maximum water flow, up 9.5 gallons a minute, it provides the full water spray you need to tackle any job. Simply pull back on the extra-large lever to easily control the water flow and spray dirt away from the siding, rinse off the walkway, or quickly wash the car. Multiple spray patterns make it easy to complete all of your outdoor chores.



Item #	Desc	UPC	Vendor	CS/UOS	Location
81780092	Torrent	422060904041	90404	4/4	West



XT Metal 7-Pattern Nozzle

Heavy duty, metal construction. Offers seven spray patterns for all your watering needs. Slip-resistant rubberized grip, trigger and head.



Item #	Desc	UPC	Vendor	CS/UOS	Location
81780089	Rear Trigger	042206302014	XT201	10/10	National

XT Metal Adjustable Nozzle

The XT200 metal adjustable nozzle provides a powerful jet of water to tackle even the toughest cleaning jobs. The rear trigger design and integrated lock make this nozzle easy to grip for long periods of time. Melnor® XT nozzles are built to last with a rugged metal core.



Item #	Desc	UPC	Vendor	CS/UOS	Location
81780088	Rear Trigger	042206302007	XT200	10/10	West
81780090	Front Trigger	042206403001	XT300	10/10	West

XT Metal 8-Pattern Nozzle

Tackle any chore around the house from washing the car to watering the garden, with the heavy-duty XT 8-pattern adjustable nozzle. Control the amount of water you need in one easy motion with the thumb control flow lever. The front trigger with a rubberized, slip-resistant grip makes it comfortable to handle. Melnor XT Nozzles are built with a metal core for durability you can count on.



Item #	Desc	UPC	Vendor	CS/UOS	Location
81780091	Front Trigger	042206403018	XT301	10/10	West

RelaxGrip® Adjustable Nozzle

Specially designed to provide a comfortable grip, the RelaxGrip® Adjustable Nozzle brings a new sense of ease to gardening. Spend more time outdoors without causing fatigue in your hand or wrist. Easily switch from gently watering your hydrangeas to clearing mud off the sidewalk with the adjustable spray.



Item #	Desc	UPC	Vendor	CS/UOS	Location
81780080	Rear Trigger	042206155597	R200	10/10	West
81780082	Thumb-Control	042206157324	R300	10/10	West

Heavyweight Metal Adjustable Nozzle

The heavyweight construction stands up to frequent use, with an adjustable tip to take your spray power from a fine mist in the garden to a powerful jet to clear away dirt. Featuring a slip-resistant rubberized grip, trigger, and nozzle head. Melnor® XT nozzles are built to last with a rugged metal core.



Item #	Desc	UPC	Vendor	CS/UOS	Location
81780094	Rear Trigger	042206304506	XT450	6/6	West

Heavyweight Metal 7-Pattern Nozzle

This heavyweight nozzle can be used for a variety of gardening chores and stands up to even the toughest watering needs. The 7-pattern adjustable sprayer provides watering options from a fine spray to a powerful jet. A rubberized slip-resistant grip makes it easy to handle and control while remaining comfortable in your hand.



Item #	Desc	UPC	Vendor	CS/UOS	Location
81780095	Rear Trigger	042206304513	XT451	6/6	West

Twist Nozzle

The classic design and sturdy metal Melnor® Twist Hose Nozzle is perfect for cleaning chores or watering the garden. The nozzle provides an easy to use, twisting adjustment, with spray options from a gentle mist to a blasting stream.



Item #	Desc	UPC	Vendor	CS/UOS	Location
81780116	3" Metal	042206141897	505S	10/10	West
81780111	5" Brass	042206151117	15111	6/6	West

Heavyweight Metal 7-Pattern Nozzle

The toughest cleaning jobs require the toughest cleaning tool. Designed to work with water pressure up to 120 PSI, you'll have the concentrated spray power you need to blast away stubborn dirt. Use with hot or cold water, the insulated grip protects against extreme temperatures. Spray off the deck, rinse the car, or blast dirt off the siding with the variable spray pattern. Built with a durable metal core and rubberized grip that are designed to last for years.



Item #	Desc	UPC	Vendor	CS/UOS	Location
81780106	Rear Trigger	042206004659	465C	10/10	West

RelaxGrip® 8-Pattern Pivoting Wand

RelaxGrip® handles are designed to provide a more comfortable grip, so you can get more done without putting strain on your wrists and hands. An easy to operate thumb control eliminates the need to squeeze or lock in place. Multiple spray patterns give you the flexibility to rinse off the car or shower the vegetable garden with just one tool.



Item #	Desc	UPC	Vendor	CS/UOS	Location
81780134	16" wand	042206286338	R8633	12/12	National
81780130	33" wand	042206286376	R8637-RACK	12/12	West
81780128	33" Extension wand	042206286390	R8639-RACK	12/12	West

RelaxGrip® 8-Pattern Nozzle

Designed to provide the most comfortable grip, so you can get your gardening done with ease. Multiple patterns let you water a colorful array of petunias with a gentle shower or clear off the patio with a full spray. Designed to be light-weight yet durable to last for years.



Item #	Desc	UPC	Vendor	CS/UOS	Location
81780081	Rear Trigger	042206155603	R201	10/10	National
81780087	Thumb-Control	042206155689	R821	12/12	West

Ultralight Thumb-Control 5-Pattern Nozzle

Make gardening more of a joy and less of a chore with the smooth operating Ultralight Thumb Control 5 Pattern Nozzle. Quickly switch between 5 spray options to gently water fresh herbs or rinse off the car with a strong spray. The unique bubbling pattern makes it easy to fill up a bucket and provides soaking moisture to the roots of your plants. Keep the shower head running smooth with a removable metal sieve that is easy to clean and provides a soft shower great for watering blossoming begonias. The RelaxGrip® handle and ultralight design make it comfortable to use for any gardening chore.



Item #	Desc	UPC	Vendor	CS/UOS	Location
81780085	Thumb-Control	042206155658	R551	12/12	West

Vortex® 2-Pattern Nozzle

Cleaning projects on your to-do list? Scrub away dirt and debris with the signature helix high-speed spinning spray pattern of Vortex®. Feel the power generated by this innovative nozzle to get cleaning done faster all season long. With two spray patterns, one for intense surface cleaning projects and the other meant for concentrated areas, tackle the dirtiest jobs with ease.



Item #	Desc	UPC	Vendor	CS/UOS	Location
81780140	Rear Trigger	042206156983	15698	6/6	West

Vortex® 6-Pattern Nozzle

Feel the power produced by six vigorous spray patterns of the Vortex® Rear-Trigger Nozzle. Jet, Flat, Shower, Mist, Soaker, and Vortex® spray patterns can drive away debris from gutters and sidewalks or softly water plants and flowers without switching nozzles. Constructed with an innovative trigger lock, the Melnor Vortex Nozzle prevents added hand strain from squeezing the handle too long. With the slip-resistant grip, keep hold of the nozzle while tackling both cleaning and watering projects throughout the seasons.



Item #	Desc	UPC	Vendor	CS/UOS	Location
81780141	Rear Trigger	042206157003	15700	6/6	West

Sweeper Nozzle

Cleaning paved surfaces or decks is a breeze with a sweeper nozzle. The simple design creates a wide blast of water that clears away dirt and leaves. This classic hose-end tool will last for years to come.



Item #	Desc	UPC	Vendor	CS/UOS	Location
81780117	Sweeper	042206041517	4151-6	6/6	West

Sprout 15" 8-Pattern Wand

Brighten up your outdoor spaces with a colorful 15" watering wand. The variety of spray patterns let you adjust from a gentle shower for delicate plants to a strong jet when you need to clean up around the house. Now you can easily reach those hanging baskets on the front porch to water an array of colorful petunias. Adjust the pattern to a stronger spray to quickly rinse off the whole deck, even those hard to reach areas. The front trigger and sturdy grip are designed to stay comfortable in your hands. Trusty Sprout watering tools will keep your lawn and garden healthy for years to come.



Item #	Desc	UPC	Vendor	CS/UOS	Location
81780297	Blueberry Blue	042206156822	SP15682BB	6/6	West
81780298	Gooseberry Green	042206156839	SP15683GG	6/6	West
81780299	Raspberry Red	042206156846	SP15684RR	6/6	West



Fan Hand Spray with Adjustable Spike

The fan hand spray watering delicate flowers & plantings a breeze. The wide spray head is perfect for most flower beds. The gentle spray pattern is less damaging to slender stems than a traditional nozzle.



Item #	Desc	UPC	Vendor	CS/UOS	Location
81780124	Fan Spray	042206141217	53C	12/12	West



Rear-Trigger Adjustable Nozzle

Wash, rinse, and water everything around the house with a colorful Sprout Adjustable Nozzle. Just a simple twist adjusts the water pattern from a wide spray great for lightly showering flowers to a strong jet that makes cleaning chores a breeze. Easily spray off the car on a sunny day or rinse off outdoor furniture before a summer barbeque. Trusty Sprout watering tools will keep your garden healthy and outdoor spaces clean for years to come.

Item #	Desc	UPC	Vendor	CS/UOS	Location
81780279	Blueberry Blue	042206156891	SP15689BB	6/6	West
81780280	Gooseberry Green	042206156907	SP15690GG	6/6	West
81780281	Raspberry Red	042206156914	SP15691RR	6/6	West

2025

Front-Trigger Adjustable Nozzle

Clean up around the yard with a reliable nozzle as colorful as your garden. Simply twist to adjust the water pattern from a soft spray to a strong jet. The versatile spray pattern is great for a lot of chores from watering the flowers to washing the car. Use the handy thumb control to easily adjust the water flow with one hand. Trusty Sprout watering tools will keep your garden healthy and outdoor spaces clean for years to come.

Item #	Desc	UPC	Vendor	CS/UOS	Location
81780273	Blueberry Blue	042206155795	SP15579BB	6/6	West
81780274	Gooseberry Green	042206155801	SP15580GG	6/6	West
81780275	Raspberry Red	042206155818	SP15581RR	6/6	West



Rear-Trigger 7-Pattern Nozzle

Whether you are growing fresh vegetables for a summer salad or an array of colorful flowers to brighten your outdoor space, you need the right tool to keep it all watered. Choose from seven useful spray patterns to gently shower flower pots on the deck or spray down a muddy car. The rubberized grip is designed to stay comfortable and secure in your hands. Trusty Sprout watering tools will keep your lawn and garden healthy for years to come.

Item #	Desc	UPC	Vendor	CS/UOS	Location
81780282	Blueberry Blue	042206155894	SP15589BB	6/6	West
81780283	Gooseberry Green	042206155900	SP15590GG	6/6	West
81780284	Raspberry Red	042206155917	SP15591RR	6/6	West



Front-Trigger 7-pattern Nozzle

Grow fresh vegetables and blooming flowers with a handy watering nozzle as colorful and unique as your garden. The seven versatile spray patterns let you shower vibrant marigolds on the balcony or use the full spray to wash your car on a sunny day. The comfortable front trigger and easy to use thumb flow control make any outdoor chore a breeze. Trusty Sprout watering tools will keep your lawn and garden healthy for years to come.

Item #	Desc	UPC	Vendor	CS/UOS	Location
81780276	Blueberry Blue	042206155825	SP15582BB	6/6	West
81780277	Gooseberry Green	042206155832	SP15583GG	6/6	West
81780278	Raspberry Red	042206155849	SP15584RR	6/6	West

Sunrise™ Once-a-Day Water Timer

The Sunrise™ Once-a-Day timer takes care of watering the plants for you. Absolutely no programming. The sun starts the watering process and automatically turns off when it's done. Simply set the amount of time you want to water and SunRise™ does the rest.



Item #	Desc	UPC	Vendor	CS/UOS	Location
81780013	Timer	042206230126	13012	4/4	National

Automatic Timer

Monitor how much water you use with this flow meter. Attaches between the faucet and the hose and is activated with the simple twist. Turn the knob to the amount of water you wish to use and the unit will turn off when that amount is achieved. Ideal for newly planted trees and shrubs.



Item #	Desc	UPC	Vendor	CS/UOS	Location
81780016	Automatic Timer	042206143907	101	4/4	West

Mechanical Aqua Timer

The Mechanical Aqua Timer is an easy to use mechanical timer perfect for watering when you do not need daily automation. When you are ready to water just turn the dial clockwise to the desired duration setting, 15 minutes to 2 hours, and it will shut off when the time has completed. No more over watering!



Item #	Desc	UPC	Vendor	CS/UOS	Location
81780015	Aqua Timer	042206030108	3010-4	4/4	West



2-Way Hose Connectors w/ Shut-Off Valves

Item #	Desc	UPC	Vendor	CS/UOS	Location
81780250	A Metal	042206090003	9000	10/10	National
81780251	B Chrome	042206142009	312S	10/10	National
81780252	C Plastic	042206142214	313S	10/10	National

EZ-Flow™ Control Valve

Convert 1 faucet into high flow water streams. The clever lever design eliminates the need to constantly twist or turn a difficult faucet. With the EZ-Flow Control Valve just flip to control the water on each valve to easily control a sprinkler and run the hose to wash off the car at the same time.



Item #	Desc	UPC	Vendor	CS/UOS	Location
81780238	2-way	042206003560	356	6/6	West
81780239	4-way	042206003577	357	6/6	West



4-Zone Bluetooth® Water Timer

Take the hassle out of watering the garden. The innovative Bluetooth timer works with the Melnor BT App to easily set watering schedules directly from your smart device. Choose up to twelve unique watering start times to match your specific lawn and garden needs. If rain is in the forecast, use the Watering Delay feature to pause the schedule for up to seven days. The regular schedule will resume once the delay is over. If you need to see when the next watering cycle is scheduled or when the current cycle will end? Check the app to see what's going on or make a quick change. Switch over to Manual Mode through the app or directly at the valve to turn on the water whenever you need it.

Item #	Desc	UPC	Vendor	CS/UOS	Location
81780012	1-Zone Bluetooth Timer	042206930156	93015	4/4	West
81780011	2-Zone Bluetooth Timer	042206931009	93100	4/4	West
81780010	4-Zone Bluetooth Timer	042206932808	93280	4/4	West

Inline Hose Filter

Protect your gardening tools from harsh water with the Inline Hose Filter. Easily connect the Inline Filter between the faucet and the hose. Great for homeowners with well water or water impurities, the removable filter makes cleaning easy. Simply remove the durable stainless steel filter tray and wash off any dirt, sand, and grit before re-inserting. Keep your favorite gardening tools in good condition by stopping dirt and grit from reaching them through the water.



Item #	Desc	UPC	Vendor	CS/UOS	Location
81780266	Inline Filter	042206157393	15739	5/5	West

HiFlo™ 4-Way Hose Valve

Large size allows greater water flow and large knobs ensure easy operation. Durable ABS construction.



Item #	Desc	UPC	Vendor	CS/UOS	Location
81780242	4 Way	042206003379	337-6	6/6	National

2025



Metal Hose Valve

Adding a shut-off to a hose end or faucet provides an easy way to control water flow with the twist of a switch. The Melnor Metal Hose Valve is made of metal for a long-life while the valve provides simple flow control.



Item #	Desc	UPC	Vendor	CS/UOS	Location
81780256	Hose Shut-Off	042206090010	9001	10/10	West

Product Adapter

The Melnor QuickConnect™ System makes switching watering tools fast and easy. Attach the Product Adapters to your existing nozzles, sprinklers, or watering wands to make hose connections a snap. Spray off the deck with a nozzle then swap it out for a sprinkler when it's time to water the lawn. Add a QuickConnect™ Product Adapter to each of your favorite tools, so they are ready to go when you need them. Works with Melnor® Product End Connector with Water Stop to change tools even with the water running.



Item #	Desc	UPC	Vendor	CS/UOS	Location
81780149	Product Adapter	042206246516	1MQC	10/10	West

4-Way Metal Hose Connector with Built-in Shut-off Valves

Operate up to four hoses from one faucet with the Melnor Metal 4-Way Hose Valve. Its solid metal construction ensures a reliable connection to your outdoor faucet, and a free-spinning coupling nut makes this hose splitter easy to install. This 4-way valve lets you control the water supply for each hose with independent levers, so you can turn different water streams on and off effortlessly.



Item #	Desc	UPC	Vendor	CS/UOS	Location
81780255	4 Way	042206090096	9009	5/5	West

Metal Swivel Hose Connector

Attach this connector to your faucet to allow side to side movement for your garden hose. This item helps prevent kinks and allows you to move your garden hose with ease.



Item #	Desc	UPC	Vendor	CS/UOS	Location
81780249	Pivot & Swivel	042206156976	15697	10/10	West
81780260	Swivel	042206142344	360S	10/10	West



Hose Repair Metal Clinch Couplers

Item #	Desc	UPC	Vendor	CS/UOS	Location
81780172	3/4" Female	042206142610	20Z3/4	10/10	National
81780175	3/4" Male	042206142672	25Z 3/4	10/10	West
81780174	5/8" Male	042206142665	25Z 5/8	10/10	West
81780178	3/4" Mid-Hose	042206142733	30Z 3/4	10/10	West
81780180	5/8" Repair Set	042206025586	2558	10/10	West

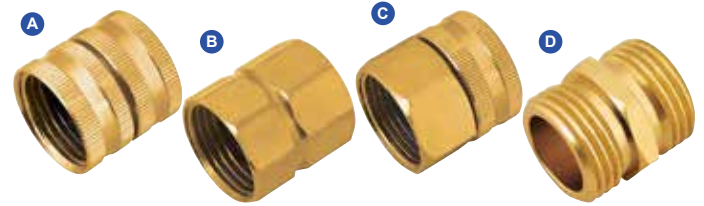

Metal Double Connector

Item #	Desc	UPC	Vendor	CS/UOS	Location
81780217	A Female	042206143501	59Z FB	10/10	West
81780224	B 3/4" Female	042206143587	63Z 3/4	10/10	West
81780226	C 3/4" Female	042206143617	64Z 3/4	10/10	West
81780216	D Male	042206143518	59Z MB	10/10	West
81780219	3/4" Male	042206143532	60Z 3/4	10/10	West
81780220	1/2" Male	042206143549	61Z	10/10	West

XT Metal Connectors

Makes switching watering tools a snap. Attach the quick connect coupling to the end of the hose and screw in the product adapter to any standard nozzle, sprinkler or other watering tool.



Item #	Desc	UPC	Vendor	CS/UOS	Location
81780157	Male	042206142290	47C	10/10	West
81780156	Female	042206000460	46C	10/10	West
81780155	2 piece kit	042206142276	45C	10/10	West

Heavy Duty All Metal Hose Repair



Item #	Desc	UPC	Vendor	CS/UOS	Location
81780215	3/4" Female	042206145727	ZBF3/4	10/10	West
81780213	3/4" Male	042206145710	ZBM3/4	10/10	West

Plastic Cap Nut

This item can be used to replace in-series connection caps on your watering accessories or use it to seal the end of a hose for in-series sprinklers, etc.



Item #	Desc	UPC	Vendor	CS/UOS	Location
81780261	3/4"	042206143303	40	10/10	West



Hose Coupling Connectors

Item #	Desc	UPC	Vendor	CS/UOS	Location
81780165	A 5/8" or 3/4" Mid-Hose	042206145062	02MC	10/10	National
81780164	3/8" or 1/2" Mid-Hose	042206145055	01MC	10/10	West
81780168	B 5/8" or 3/4" Female	042206145031	2FMC	10/10	National
81780166	3/8" or 1/2" Female	042206145017	1FMC	10/10	West
81780169	C 5/8" or 3/4" Male	042206145048	2MMC	10/10	National
81780167	3/8" or 1/2" Male	042206145024	1MMC	10/10	West

Brass Hose Repair with Clamp



Item #	Desc	UPC	Vendor	CS/UOS	Location
81780182	5/8"	042206153678	15367	10/10	National

Metal Repair Coupling with Steel Clamp



Item #	Desc	UPC	Vendor	CS/UOS	Location
81780200	1/2" Female	042206143204	22Z 1/2	10/10	West
81780206	5/8" Female	042206143242	28Z 5/8	10/10	West
81780205	1/2" Male	042206143235	28Z 1/2	10/10	West

Brass Hose Repair Set



Item #	Desc	UPC	Vendor	CS/UOS	Location
81780184	5/8" Set	042206153708	15370	10/10	National

Hose Washers

Replacement for worn out hose washers. Fits all sizes. 12 per card.



Item #	Desc	UPC	Vendor	CS/UOS	Location
81780265	12 pk	042206143280	200C	30/30	National

Flat Soaker Hose

Waters with minimal run-off. Easier to use than standard soaker hoses. Easier to bend and store. Rolls up tight to store in a small space.



Item #	Desc	UPC	Vendor	CS/UOS	Location
81780232	50'	042206860507	86050-12	12/12	National
81780231	75'	042206860750	86075-12	12/12	National

Mossify

Mossify Squirt™ - Liquid Squirter

These Mossify squirts are a handy alternative if you are looking to get water in very tight spaces. You can fill it up with anything that carries the same properties as water does. 500ml



Item #	Desc	UPC	Vendor	CS/UOS	Location
82370053	Clear	660111996946	SQRT-CL-0001	12/12	National
82370054	Pink	660111996953	SQRT-PI-0001	12/12	National

The Mossify Mistr™ - Electric Mister

Increase humidity for your plants using the fully rechargeable Mossify Mistr. With one click, you will have a continuous fine mist to provide extra humidity to all of your tropical foliage. With a capacity of 750ml, this sleek and stylish mister will have your plants thanking you for the additional moisture in the air. Comes with USB charger



Item #	Desc	UPC	Vendor	CS/UOS	Location
82370007	Mister	716252512283	MISTR-0001	12/12	National



Gnome Watering Can

"Gnute the Gnome" Novelty's gnome watering can stands tall as a sentry over the garden. This 1.5-gallon can is sure to be a classic piece of garden art. 100% recyclable.

Item #	Desc	UPC	Vendor	CS/UOS	Location
80250488	1.5 gal.	026978309013	30901	10/10	National

Indoor Watering Can

This watering can is designed for indoor use. Made of recyclable, impact resistant plastic. Watering can has a flower design indentation on the side for added styling. Features a curved loop handle and long stem spout for comfort and ease of use.



Item #	Desc	UPC	Vendor	CS/UOS	Location
80250622	Red 1 gal.	026978307057	30705	6/6	National
80250115	Sky 1 gal.	026978307026	30702	6/6	National



Outdoor Watering Cans

Comfortable handle for outdoor use.

Item #	Desc	UPC	Vendor	CS/UOS	Location
80250617	2 gal Sky Blue	026978304025	30402	12/12	National
80250322	2 gal Bright Blue	026978304094	30409	12/12	National
80250827	2 gal Green	026978304131	30413	12/12	National
80250826	2 gal Red	026978304117	30411	12/12	National

Classic Gardener's Outdoor Watering Can

2-gallon capacity classic watering can. Features a twist off white nozzle.



Item #	Desc	UPC	Vendor	CS/UOS	Location
80250318	Green 2 gal.	026978303011	30301	12/12	National

Indoor Watering Cans

This watering can is designed for indoor use. Made using recyclable, impact resistant plastic. Watering can has a flower design indentation on the side for added styling. Features a curved loop handle and long stem spout for comfort and ease of use.



Item #	Desc	UPC	Vendor	CS/UOS	Location
802509331	Green 1/2 gal.	026978306012	30601	6/6	National
80250114	Pearl 1/2 gal.	026978306029	30602	6/6	National
80250621	Red 1/2 gal.	026978306050	30605	6/6	National

Babs - Pig Watering Can

Babs, Novelty's affable pig watering can, holds 1 3/4 gal. of water. Kids and pig lovers alike adore this fine swine watering vessel.



Item #	Desc	UPC	Vendor	CS/UOS	Location
80250029	Pink 1 3/4 gal.	026978305008	30500	10/10	National

Squirt - Fish Watering Can

The fish are flying at Novelty. Making a big splash at the pool, beach or in the garden, Squirt, watering can, appeals to "kids" of all ages. Keeping our earth and waters eco-friendly, Novelty watering cans are recyclable.



Item #	Desc	UPC	Vendor	CS/UOS	Location
80250030	Orange 3/4 gal	026978308061	30806	6/6	National

Lucky Duck Watering Can

With a comfortable handle and easy pouring features, this one gallon darling is a winner.



Item #	Desc	UPC	Vendor	CS/UOS	Location
80250486	Yellow 1 gal.	026978301048	30104	6/6	National

PANACEA®

Vintage Galvanized Watering Can

Give plants the nourishment they need with this watering can that boasts a vintage design.



Item #	Desc	UPC	Vendor	CS/UOS	Location
80161140	1 gal	093432848821	84882	4/4	National
80161137	2 gal	093432848807	84880	4/4	National



Basic Heavy Duty Steel Hose Hanger (A)

Item #	Desc	UPC	Vendor	CS/UOS	Location
80161597	Black	093432840757	84075	6/6	National
80160265	Green	093432894750	89475	6/6	National

Scroll Hose Hanger (B)

Item #	Desc	UPC	Vendor	CS/UOS	Location
80160259	Scroll	093432840092	84009	4/4	National

Gothic Steel Hose Hanger (C)

Item #	Desc	UPC	Vendor	CS/UOS	Location
80161598	Gothic	093432844076	84076	6/6	National

Star Hose Hanger (D)

Item #	Desc	UPC	Vendor	CS/UOS	Location
80160144	Star	093432840153	84015	4/4	National

Soil Moist™

Soil Moist™ Mats

The mats reduce plant waterings as they slowly release water back to the plant roots. Simply add the mat towards of the pot, add soil and add plant. Works great in hanging baskets too!



Item #	Desc	UPC	Vendor	CS/UOS	Location
80040009	7"x7" Mat	030541088786	SMMS	12/12	National

Soil Moist™ Vacation Mats

Soil Moist Vacation Mats contain water storing polymer woven into a cloth for interior plants to reduce waterings. Simply place your house plants on the mat and through capillary action, plants are watered for up to three weeks. There are two 15 3/4" x 11" mats per pack.



Item #	Desc	UPC	Vendor	CS/UOS	Location
80040022	Vacation Mats	030541088793	SMVS	12/12	National



FiberFlex Hose

The FiberFLEX Fiber Jacket Hose is lightweight, kink-free and easy storage for all household uses. Features anodized aluminum coupling material. Heavy-duty fabric garden hose that resists scratches, scuffs and snags. 600 PSI burst strength. Durable dual-layer construction featuring a marine-grade fiber jacket around a flexible hybrid-polymer core. 50 percent lighter than traditional garden hoses for effortless handling and easy maneuverability.



Item #	Desc	UPC	Vendor	CS/UOS	Location
82160124	5/8" X 50'	078627044127	CSNFF58050CC	8/8	East

XFlex Hose

From the innovation experts at Swan comes the XFlex, a truly revolutionary garden hose that combines all the most sought-after features in garden hose functionality. From lightweight and long-lasting to kink-resistant, its the perfect water hose for the landscaper and active home gardener. Ultra lightweight, rugged performance. Flexible at all temps. Ergonomic female and male grips make attachment quick and easy.



Item #	Desc	UPC	Vendor	CS/UOS	Location
82160033	5/8" X 50'	078627043601	CSNXF58050	6/6	East
82160119	1/2" X 100'	078627043847	CSNXF12100	4/4	East



Element Contractor/Farm® Hose

For those who need to supply a high volume of water over a large area such as a farm, construction site or stretch of landscape, Swan's Element Contractor/FARM® hose has several features that make it the ideal contractor farm hose for both construction and agricultural needs, from cleaning debris off a worksite to watering trees.



Item #	Desc	UPC	Vendor	CS/UOS	Location
82160041	3/4" X 50'	078627348720	CELOF34050	5/5	East
82160043	3/4" X 100'	078627348744	CELOF34100	2/2	East
82160045	5/8" X 75'	078627588737	CELOF58075	3/3	East
82160046	5/8" X 100'	078627588744	CELOF58100	3/3	East

2025

WeatherFLEX® Hose

Swan's WeatherFLEX® all-weather hose is a medium-duty garden hose perfect for everyday watering tasks such as watering the garden, watering the lawn and general cleanup. With a 5/8-inch inside diameter and strong 300+ PSI burst strength, the WeatherFLEX® water hose delivers just the right amount of water at the right speed for all of your outdoor needs.



Item #	Desc	UPC	Vendor	CS/UOS	Location
82160028	5/8" X 25'	078627582216	CSNWF58050	5/5	East
82160029	5/8" X 50'	078627582223	CSNWF58050	5/5	East
82160030	5/8" X 75'	078627582230	CSNWF58075	3/3	East
82160031	5/8" X 100'	078627582247	CSNWF58100	3/3	East

Soft & Supple Hose

The Classic, Swan Soft and Supple 5/8 in. hose features lead-free, crush-proof aluminum couplings that can withstand being trampled or run over by garden equipment. The abrasion-resistant cover keeps the hose in top shape year after year and, with a limited lifetime warranty, you can be sure that you'll be using this garden hose over the long term. The 100 ft. is perfect for a standard yard or landscaping project, giving you plenty of reach without sacrificing water volume.



Item #	Desc	UPC	Vendor	CS/UOS	Location
82160023	5/8" X 25'	078627583312	CSNSS58025	5/5	East
82160024	5/8" X 50'	078627583329	CSNSS58050	5/5	East
82160025	5/8" X 75'	078627583336	CSNSS58075	3/3	East
82160026	5/8" X 100'	078627583343	CSNSS58100	2/2	East



Never Dry Plant Pal Mini - Single

Great for keeping your potted plants watered while on vacation. No more coming home to dried out plants! Clay base releases water when the soil needs it. Waters your plants by diffusion.



Item #	Desc	UPC	Vendor	CS/UOS	Location
81510145	Mini Single Clear Kit	038858135742	6713-24-00	24/24	National



Never Dry Plant Pal Mini

Great for keeping your potted plants watered while on vacation. No more coming home to dried out plants! Clay base releases water when the soil needs it. Comes in assorted colors: green, blue, and clear.

Item #	Desc	UPC	Vendor	CS/UOS	Location
81510146	MINI Asst Plant Pal Kit	038858135759	6717-12-769	12/12	National

Beehive Mister Assortment

Tending to a terrarium with precision and style takes the right tools and our Beehive Mister assortment is as stylish as it is functional. These metal plant misters make the perfect add-on to any terrarium or gift display.



Watering air plants and orchids just got easier! Available in two metallic finishes - a chic matte copper and pewter gray - these misters come in an assorted PDQ for easy merchandising.

Item #	Desc	UPC	Vendor	CS/UOS	Location
81510393	Case of 6	038858606174	9687-06-1242	6/6	National

Cylinder Mister Assortment

Tending to a terrarium with precision and style takes the right tools and our Cylinder Mister assortment is as stylish as it is functional. These metal plant misters make the perfect add-on to any terrarium or gift display. Watering air plants and orchids just got easier!



Available in two metallic finishes - a chic matte copper and pewter gray - these misters come in an assorted PDQ for easy merchandising.

Item #	Desc	UPC	Vendor	CS/UOS	Location
81510394	Case of 6	038858606198	9687-06-1242	6/6	National



Plant Mister

Care for your plants in style. This mister gently waters your succulents and air plants. Glass bulb base with brass nozzle and mister components. Both decorative and functional, these plant misters make the perfect add-on to any terrarium gift. Assortment includes one each color: purple, amber, seaglass, vintage green, and two crystal clear.

Item #	Desc	UPC	Vendor	CS/UOS	Location
81510153	Clear	038858135841	9685-06-09	6/6	National
81510172	Purple	038858135889	9685-06-425	6/6	National
81510300	Assorted	038858108166	9685-06-4502	6/6	National



Never Dry Plant Pal

Great for keeping your potted plants watered while on vacation. No more coming home to dried out plants! Ceramic design releases water slowly. Comes in assorted colors: green, blue, and clear

Item #	Desc	UPC	Vendor	CS/UOS	Location
81510147	Asst Plant Pal Kit	038858135766	6718-12-769	12/12	National



Kids Pails

Children can easily make sand castles, carry water, and toys. 16 piece assorted case pack, four of each color: pink, green, blue, and orange. 7.25"W x 7.25"D x 6"H

Item #	Desc	UPC	Vendor	CS/UOS	Location
81550085	Kids Metal Pails	017783050801	5080	16/16	National



1 pt. Mini Plastic Watering Can

Kids can easily water plants. Great for indoor plants too. 10"W x 2.75"D x 5.5"H

Item #	Desc	UPC	Vendor	CS/UOS	Location
81550538	1pt. Blue	400278950015	5001B	25/25	National
81552204	1pt. Pink	4027371121246	5001P	25/25	National
81550539	1pt. Green	400278950017	5001G	25/25	National

Kids Watering Can

Kids can water plants like grown ups with these brightly colored watering cans. 16 piece assorted case pack, four of each color: pink, green, blue, and orange. 9"W x 3.5"D x 6"H



Item #	Desc	UPC	Vendor	CS/UOS	Location
81550084	Kids Metal Watering Cans	017783050702	5070	16/16	National



Elephant Watering Can

Stands about 8" tall, 15" long and holds 2 quarts--the perfect size for your window box flowers or house plants.



Item #	Desc	UPC	Vendor	CS/UOS	Location
81320029	Grey	078304631824	63182	12/12	East



Watering Can

Features a replaceable screw on sprinkler head and floral design on the sides. Can stands about 13" tall, 17" long and holds 2 gallons.

Item #	Desc	UPC	Vendor	CS/UOS	Location
81320019	Caribbean Blue	078304630667	63066	12/12	East
81320018	Hunter Green	078304630650	63065	12/12	East
81320021	Sage Green	078304630681	63068	12/12	East
81320092	Purple	078304630711	63071	12/12	East



Indoor Watering Can

This 1/2 gallon, metal, indoor watering can comes in an assortment that includes pink, yellow, blue, purple and green. For indoor use only. 2 of each color (Five colors)



Item #	Desc	UPC	Vendor	CS/UOS	Location
81730326	Assorted	745487082803	8280	10/10	East



Watering Can with Copper Accents

This striking design combines a sturdy galvanized steel body with copper accents on both handles, rosette cap, and bottom band to create a decorative and highly functional watering can. Heavy duty galvanized steel construction for long life and rust resistance. Threaded removable rosette-diffuser creates a gentle shower of water to leave mulch and soil undisturbed; perfect for young seedlings. Angled neck spout reaches well inside your foliage. Suitable for both indoor and outdoor use.

Item #	Desc	UPC	Vendor	CS/UOS	Location
81730035	1gal Steel/ Copper	745487983261	8326	6/6	East
81730036	1gal Green/ Copper	745487983278	8327	6/6	East
81730037	1.9gal Steel/ Copper	745487083305	8330	4/4	East



Galvanized Watering Can

1 gallon capacity. Galvanized watering can with powder coated finish.

Item #	Desc	UPC	Vendor	CS/UOS	Location
81730341	Heritage Blue	814567025372	8350	4/4	East
81730342	Sunshine Yellow	814567025389	8351	4/4	East
81730343	Heritage Scarlet	814567025396	8352	4/4	East

PLANT CARE & FOOD



CHECK OUT OUR CLEARANCE ITEMS!

DROP SHIP VENDORS

Espoma (cased goods):

Minimum of 300 units
\$75 stop charge for LTL shipments
\$250 liftgate fee (8 pallets or less)



Griffin Greenhouse Retail WAREHOUSE Shipping Map

We are now shipping nationwide!

NATIONAL



2025

Refer to location key:

National items are stocked nationally
 Select items are sold East or West only; no exceptions

8" Kaleidoscope Planter

Premium plastic modular planter can be displayed individually each planter has a removable saucer ideal for succulents or shallow rooted planted.

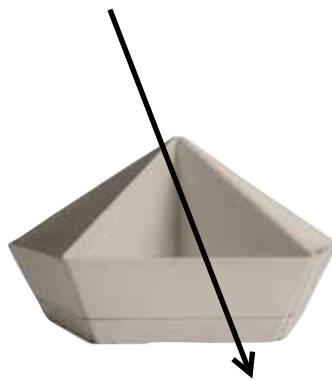

Item #	Desc	UPC	Vendor	CS/UOS	Location
80282643	Vanilla Bisque	770932844170	KDP08000A58	6/6	National

Where is the pricing?

1. Scan QR code on Chapter Pages to see pricing on Griffins.com
2. Contact your Griffin Sales Representative
3. Call into Griffin Customer Service 800.888.0054



ARBER

Plant Food Concentrate 3-2-1

Certified for Organic Gardening by CDFA/OIM. Improves your plant's uptake of essential nutrients, strengthening from root to shoot. Nutritional supplement for indoor gardening and houseplants.



Item #	Desc	UPC	Vendor	CS/UOS	Location
82200009	8 oz	850025915212	2-411762-2	6/6	East
82200004	16 oz	850025915021	2-411712-1	6/6	East



Liquid Iron Complex

Promotes vigorous growth and dark green color. Corrects iron deficiency. Use on turf, flowers, shrubs, trees, etc. Contains iron and sulfur. Chelated. **Not For Sale PA**



Item #	Desc	UPC	Vendor	CS/UOS	Location
80100001	32 oz. Con.	037321002994	299	12/12	National

Root-N-Grow 4-10-3

Fertilizer with IBA growth hormone Stimulates early and strong root formation. Promotes greener, more vigorous plants. Weatherproof packaging permits outside merchandising. **Not For Sale PR**



Item #	Desc	UPC	Vendor	CS/UOS	Location
80100404	Con. qt.	037321004127	412	12/12	National

Rose Rx Systemic Drench

Rose-Rx Systemic Drench provides up to 6 weeks of both insect and disease control for your roses, listed flowers, and ornamentals. There is no messy spraying, just pour along the base of the plant. One quart treats up to 16 roses. **Not For Sale AK, CO, CT, HI, ME, MD, MA, NV, NJ, NY, PR, RI, VT**



Item #	Desc	UPC	Vendor	CS/UOS	Location
80101146	32 oz. Con.	037321009634	9636	6/6	National

Captain Jack's Neem-Max

Neem Max Spray by Bonide is a complete 4-in-1 insecticide, fungicide, miticide, and nematocide solution. Control over 40 types of insects and prevent disease on a wide variety of vegetables, fruit trees, berry bushes, herbs and spices, bulbs, and more!



Item #	Desc	UPC	Vendor	CS/UOS	Location
80101145	1pt. RTS Not For Sale AL, AK, AR, CA, CT, DC, HI, IL, IN, IA, KS, LA, MD, MA, MI, MN, MO, MT, NE, NM, NY, NC, ND, OH, OR, PR, SD, TN, TX, UT, VT, WA, WV	037321020103	2010	6/6	National
80101144	1qt. RTU Not For Sale PR,SD	037321020097	2009	6/6	National

Captain Jack's DeadBug Brew® Dust

Dead Bug Brew kills bagworms, borers, beetles, caterpillars, codling moth, gypsy moth, loopers, leaf miners, spider mites, tent caterpillars, thrips and more. Designed for outdoor residential use in home gardens, lawns, and ornamentals. Contains Spinosad, which is a leading pesticide used worldwide in the production of organic produce. This container is a dust applicator. Shake over plants to be treated or crush the sides of the canister in and rapidly squeeze and release in order to get a bellows dusting effect. Follow the instructions for each plant.



Item #	Desc	UPC	Vendor	CS/UOS	Location
80101143	1 lb.	037321002567	256	10/10	National



Flowers & Vegetables 13-13-13 (A)

Excellent for all flowering shrubs, trees, landscape plants, foliage, houseplants, ferns, palms, grasses and herbs. Contains balanced rates of NPK + micro nutrients to aid in the establishment of roots, strong stems and branches, greener foliage and more blooms. Feeds continuously for up to 9 months.

Item #	Desc	UPC	Vendor	CS/UOS	Location
81830051	1 lb.	785344059128	82080	12/12	East

All Purpose 18-6-8 (B)

Excellent for all flowering shrubs, trees, landscape plants, foliage, houseplants, ferns, palms, grasses and herbs. Contains balanced rates of NPK + micro nutrients to aid in the establishment of roots, strong stems and branches, greener foliage and more blooms. Feeds continuously for up to 9 months.

Item #	Desc	UPC	Vendor	CS/UOS	Location
81830049	1 lb.	785344059517	82060	12/12	East

All Purpose Select 15-5-9 (C)

Excellent for all flowering shrubs, trees, landscape plants, foliage, houseplants, ferns, palms, grasses and herbs. Balanced rates of NPK plus micros. Also contains calcium for growth and structure. Feeds continuously up to 9 months. Contains necessary micronutrients. Environmentally sustainable. Feeds continuously for up to 9 months.

Item #	Desc	UPC	Vendor	CS/UOS	Location
81830045	2 lb.	785344887769	82020	12/12	East

Cactus & Succulent 18-6-8 (D)

Dynamite Cactus & Succulent Food has been specially formulated to feed all succulents and cacti. Contains not only NPK but a full range of micro nutrients to help your cacti & succulents thrive. Can be used in ground or container plantings. Feeds continuously for up to 6 months.

Item #	Desc	UPC	Vendor	CS/UOS	Location
81830055	1 lb.	79925082170	82170	12/12	East

Mater Magic® 8-5-5 (E)



Dynamite Mater Magic® is the easy way to grow bigger, juicier tomatoes. Mater Magic can be used on plants in-ground or in containers with amazing results.

Item #	Desc	UPC	Vendor	CS/UOS	Location
81830047	.675 lb.	785344059104	82030	8/8	East

Coast of Maine



Stonington Blend™ Organic Plant Food with Lobster, Kelp & Worm Castings (5-2-4)

Made with lobster, crab, fish and kelp meal plus worm castings and other important natural ingredients. This exceptional fertilizer will super charge the biological activity of your soil, giving all your plants a significant boost. It is also high in calcium (4%) and a range of macro and micronutrients to help improve plant vigor! OMRI Listed.

Item #	Desc	UPC	Vendor	CS/UOS	Location
81600015	4 lb.	609853000618	SP6000	8/8	East

Fish Bone Meal Organic Plant Food for Buds & Blooms - (5-13-0) with 1% Calcium

An exceptional organic fertilizer ideal for budding and blooming plants. Made from dehydrated fish bones, it is an excellent natural source of phosphorus, calcium, nitrogen, essential minerals and trace elements. Available in 3lb bags. OMRI Listed.

Item #	Desc	UPC	Vendor	CS/UOS	Location
81600016	3 lb.	609853000726	FM6000	8/8	East

Lobster Meal Organic Plant Food for Greening & Leafing (6-2-0) with 8% Calcium

Made entirely of chitin-rich lobster and crab shell, this is the ideal organic fertilizer for outdoor containers, vegetable, herb and flower gardens. Natural nitrogen and calcium help promote strong stem growth, healthy green foliage, and vigorous roots. Available in 4lb bags. OMRI Listed.

Item #	Desc	UPC	Vendor	CS/UOS	Location
81600017	4 lb.	609853000696	LM6000	8/8	East

Kelp Meal All Purpose Organic Plant Food (1-0-1) with 1% Calcium

100% dehydrated Norwegian Kelp (common seaweed), a source of trace quantities of macro and micro nutrients that will help promote healthier plants and improve crop yields. Use around trees and shrubs, on lawns and in garden beds or to top-dress containers.

Item #	Desc	UPC	Vendor	CS/UOS	Location
81600018	4 lb.	609853000702	KM6000	8/8	East

Coast of Maine

Squid Concentrate All Natural Plant Food for Indoor Plants (2-3-0)

A truly remarkable fertilizer made entirely of squid. Intended to promote budding and blooming, this concentrated fertilizer also enriches the soil with plant-ready minerals, giving your plants a significant boost! Great for greenhouse and hydroponic systems and both indoor and outdoor applications.



Item #	Desc	UPC	Vendor	CS/UOS	Location
81600034	1 quart	609853000764	SQ7000	12/12	East



CAPE COD
Challenger Green



We collect food waste from our local communities and recycle it into plant food. The Project was developed to provide job skills training and opportunities for individuals with disabilities, as well as repurposing food waste into a usable product.

Item #	Desc	Size	CS/UOS	Location
82190003	5-0-6 All Purpose	2 lb	12/12	East
82190001	4-0-4 Hydrangea	2 lb	12/12	East
82190002	5-0-6 Tomato	2 lb	12/12	East

**Available for sale in CT, MA, ME, NH, NY, RI, NJ, PA, & VT*







GARDEN MINERALS

Garden Gypsum



Garden Gypsum improves the physical condition of landscape, lawn and garden soils while adding calcium and sulfur. Commonly used to reduce soil compaction and increase drainage in heavy clay soils, gypsum is also used to help remediate and revitalize alkaline, sodic or saline soils.



Item #	Desc	UPC	Vendor	CS/UOS	Location
82390081	5 lb	714360078905	07890	6/6	National

Garden Lime



Garden lime sweetens your soil (raises the pH) to improve plant growth and maximize fertilizer performance. Natural limestone is ground into an ultra-fine powder and then formed into uniform mini granules (prills) for easy spreading and rapid reaction time. Lime supplies calcium, an essential nutrient required for proper plant growth.

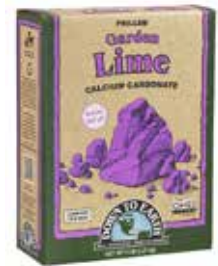

Item #	Desc	UPC	Vendor	CS/UOS	Location
82390070	5 lb	714360078707	07870	6/6	National

Dolomite Lime



Dolomite Lime supplies essential nutrients calcium and magnesium, and sweetens your soil (raises the pH) to improve plant growth and maximize fertilizer performance. Magnesium is the element that causes plants to be able to convert light into energy. Natural limestone is ground into an ultra-fine powder and then formed into uniform mini granules (prills) for easy spreading and rapid reaction time.

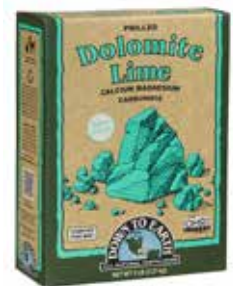

Item #	Desc	UPC	Vendor	CS/UOS	Location
82390075	5 lb	714360078806	07880	6/6	National

Garden Sulfur



Garden Sulfur is a valuable amendment that can lower soil pH, help improve soil characteristics, and enhance plant nutrient availability. When dealing with problem soils, such as alkaline or saline soil, it is important to address the conditions that are negatively affecting plant growth. If your hydrangeas, blueberries or evergreens aren't performing up to expectations, unsuitable soil pH may be the root cause.



Item #	Desc	UPC	Vendor	CS/UOS	Location
82390157	5 lb	714360078981	07898	6/6	National



SINGLE INGREDIENTS



Alfalfa Meal 2-0-1

Alfalfa Meal 2-0-1 is an exceptional source of plant-derived nutrients for the garden. It is highly recommended for roses as well as all other vegetables, herbs, flowers and shrubs. Our Alfalfa Meal is derived from sun cured, non-genetically modified alfalfa that is freshly milled to preserve the highest plant nutrient value.

Item #	Desc	UPC	Vendor	CS/UOS	Location
82390112	0.5 lb	714360178858	17805	12/12	National
82390079	4 lb	714360078851	07885	6/6	National
82390132	25 lb	714360256822	25682	1/1	National

Bone Meal 3-15-0

A wonderful source of phosphorous and calcium for flowering plants, trees and ornamentals, Down To Earth™ Bone Meal 3-15-0 is also recognized as the ideal organic fertilizer when planting bulbs.

Item #	Desc	UPC	Vendor	CS/UOS	Location
82390064	5 lb	714360078585	07858	6/6	National
82390023	25 lb	714360024018	02401	1/1	National
82390018	50 lb	714360019618	01961	1/1	National

Fish Bone Meal 4-12-0

Down To Earth's Fish Bone Meal 4-12-0 is a marine-based alternative to traditional terrestrial bone meal options and is a great source of organic phosphorus and calcium.

Item #	Desc	UPC	Vendor	CS/UOS	Location
82390118	1 lb	714360178728	17872	12/12	National
82390071	5 lb	714360078721	07872	6/6	National
82390042	25 lb	714360041251	04125	1/1	National

Kelp Meal 1-0.1-2

Kelp Meal 1-0.1-2 is pure Ascophyllum nodosum seaweed from the clean, cold waters of the North Atlantic Ocean. Hand-harvested, carefully dried and finely milled, DTE Kelp Meal 1-0.1-2 is an ideal nutrient supplement for all types of vegetables, herbs, flowers and perennials.

Item #	Desc	UPC	Vendor	CS/UOS	Location
82390072	4 lb	714360078738	07873	6/6	National

Langbeinite 0-0-22

Langbeinite 0-0-22 is a naturally mined crystalline mineral that supplies the water-soluble sulfate form of three vital plant nutrients: potassium, magnesium and sulfurs. It's maximum chlorine content is less than 3.0 percent, minimizing the potential for fertilizer "burn," and it's neutral pH does not alter soil activity.

Item #	Desc	UPC	Vendor	CS/UOS	Location
82390062	5 lb	714360078523	07852	6/6	National

Cottonseed Meal 6-2-1

Cottonseed Meal 6-2-1 is traditionally used to feed plants that thrive in lower pH soils, such as berries, flowering shrubs and evergreen trees. DTE Cottonseed Meal 6-2-1 is a high-quality plant derived source of nitrogen and can be applied throughout the growing season to promote green growth and optimum plant development.

Item #	Desc	UPC	Vendor	CS/UOS	Location
82390065	5 lb	714360078592	07859	6/6	National
82390032	20 lb	714360029310	02931	1/1	National

Bat Guano 7-3-1

Bat Guano is rich in nitrogen, phosphorus and potash and provides essential plant nutrition for vigorous vegetative growth and prolific fruit and flower development. Bat Guano is highly effective mixed into soils, applied as a side dress or steeped to make a potent guano tea or foliar spray.



Item #	Desc	UPC	Vendor	CS/UOS	Location
82390120	0.25 lb	714360178872	17887	12/12	National
82390080	2 lb	714360078875	07887	6/6	National
82390029	10 lb	714360027873	02787	1/1	National
82390090	25 lb	714360127870	12787	1/1	National



Rock Phosphate 0-3-0

Rock Phosphate is essential for building soil phosphate levels for long-term plant productivity and for preventing calcium deficient soils. It should be applied to soils prior to planting and can be mixed with compost or manures for additional soil building benefits. This premium powder grade is an excellent nutrient resource for all types of flowering plants including bulbs, fruits, shrubs, trees and vegetables.

Item #	Desc	UPC	Vendor	CS/UOS	Location
82390049	5 lb	714360078158	07815	6/6	National

Granular Humic Acids

Granular Humic Acids is a highly concentrated source of humic substances that is ideal for use on fields, turf and vegetable gardens. Carefully mined from one of the world's richest deposits, DTE Granular Humic Acids is derived from the ancient remains of decomposed organic plant materials.

Item #	Desc	UPC	Vendor	CS/UOS	Location
82390054	5 lb	714360078271	07827	6/6	National

Seaweed Meal 1-0.1-2

Seaweed Meal is pure *Ascophyllum nodosum* seaweed from the clean, cold waters of the North Atlantic Ocean. Also known as knotted-wrack or rockweed, *Ascophyllum nodosum* provides a rich natural source of potash and is an ideal nutrient supplement for all types of vegetables, herbs, flowers and perennials. Our Seaweed Meal is hand harvested, carefully dried and finely milled for consistent quality.

(ONLY for sale in OR, CA & WA)

Item #	Desc	UPC	Vendor	CS/UOS	Location
82390163	0.5 lb	714360178933	17893	12/12	West

Blood Meal 12-0-0

A readily available source of organic nitrogen, Down To Earth's Blood Meal 12-0-0 is great for heavy feeders, like corn, spinach, broccoli and leafy greens. Nitrogen is essential for all types of growing plants and an adequate seasonal supply ensures plenty of shoots, flowers, fruits and vegetables.

Item #	Desc	UPC	Vendor	CS/UOS	Location
82390113	0.5 lb	714360178070	17807	12/12	National
82390073	4 lb	714360078776	07877	6/6	National
82390028	20 lb	714360027569	02756	1/1	National

Feather Meal 12-0-0

Feather Meal 12-0-0 is derived from hydrolyzed, dried and ground poultry feathers. An all-natural source of slow-release nitrogen, it is perfect for corn, tomatoes and fall harvested vegetables. DTE Feather Meal should be incorporated into soils before planting or side dressed throughout the growing season to provide a steady release of nitrogen necessary for optimum plant growth.

Item #	Desc	UPC	Vendor	CS/UOS	Location
82390076	4 lb	714360078813	07881	6/6	National
82390131	20 lb	714360256815	25681	1/1	National

Fish Meal 8-6-0

Fish Meal 8-6-0 is recommended for vegetable gardens, flower beds and all types of outdoor plants, trees and shrubs. DTE Fish Meal 8-6-0 stimulates soil microbial life, promotes vigorous root development and provides an early season boost for all your plants.

Item #	Desc	UPC	Vendor	CS/UOS	Location
82390084	4 lb	714360078998	07899	6/6	National

Greenstone Metabasalt

Greenstone Metabasalt originates from basalt subjected to great heat and pressure over millions of years. Its naturally green color distinguishes it from unaltered basalts and comes from the presence of various minerals that were formed by these metamorphic forces. It is an excellent source of the valuable plant nutrients calcium, magnesium and iron and can be used for fortifying garden soils with these important mineral elements. Greenstone is ideal for direct application to soils or combining with other natural fertilizers, composts and soil amendments.



Item #	Desc	UPC	Vendor	CS/UOS	Location
82390158	5 lb	714360078912	07891	6/6	National

2025



Crab Meal 4-3-0

A byproduct of the West Coast crab harvest, Down To Earth's Crab Meal is a wonderful source of plant nutrients for vegetable gardens, flower beds and field crops. The coarse texture of DTE Crab Meal is ideal for improving aeration, drainage and overall soil tilth.



Item #	Desc	UPC	Vendor	CS/UOS	Location
82390082	4 lb	714360078943	07894	6/6	National

Azomite® Powder 0-0-0.2

AZOMITE is a natural mineral product mined in central Utah. This unique deposit was formed when an ancient volcano erupted and its ash settled into a prehistoric seabed creating a complex mineral composition. AZOMITE can improve plant and root system growth, crop yields, and quality as well as re-mineralize nutrient depleted soils.



Item #	Desc	UPC	Vendor	CS/UOS	Location
82390111	1 lb	714360178049	17804	12/12	National
82390061	5 lb	714360078516	07851	6/6	National

Seabird Guano 0-11-0

High-phosphorus Seabird Guano throughout the flowering period for all indoor and outdoor plants. Strawberries, melons, vegetables and all types of flowers will benefit from mid-season applications to improve yields, quality and flavor while also enhancing the beneficial bacteria activity in your garden soil.



Item #	Desc	UPC	Vendor	CS/UOS	Location
82390161	5 lb	714360078615	07816	6/6	National

Island Phosphate 0-11-0

Island Phosphate is a high-phosphorus fertilizer. It can be used to dramatically increase both the amount and size of blooms throughout the flowering period for all indoor and outdoor plants. Strawberries, melons, vegetables and all types of flowers will benefit from mid-season applications to improve yields and enhance fruit quality. **(ONLY for sale in OR & CA)**



Item #	Desc	UPC	Vendor	CS/UOS	Location
82390083	4 lb	714360078967	07896	6/6	West

Neem Seed Meal 6-1-2

Neem Seed Meal is an excellent all natural fertilizer for enriching garden and agricultural soils and encouraging optimum plant development. Cold pressed from the seeds of the fast growing Neem Tree (*Azadirachta indica*), it is also referred to as neem cake.



Item #	Desc	UPC	Vendor	CS/UOS	Location
82390053	5 lb	714360078257	07825	6/6	National

BLENDS

Bio-Turf™ 8-3-5

Bio-Turf is an entirely natural granular lawn fertilizer designed to encourage deep root development to help reduce watering requirements. Bio-Turf's nitrogen-rich formula boosts early season growth while its extra potassium reduces seasonal stress due to temperature change and drought. Bio-Turf is also ideal for heavy feeding garden vegetables like corn, tomatoes and leafy greens.



Item #	Desc	UPC	Vendor	CS/UOS	Location
82390077	4 lb	714360078837	07883	6/6	National

Bio-Fish® 7-7-2

Bio-Fish is an all-purpose, nutrient-rich fertilizer ideal for vegetable gardens and all types of outdoor plants, trees and shrubs. A good source of nitrogen and phosphorus, Bio-Fish can be used throughout the growing season to promote vigorous growth, plentiful fruit and beautiful blooms. Once applied, thoroughly mix into the soil surface and water in well.



Item #	Desc	UPC	Vendor	CS/UOS	Location
82390059	5 lb	714360078042	07842	6/6	National
82390040	25 lb	714360035014	03502	1/1	National

Flower Garden 2-6-5

Flower Garden is for all the gardeners who don't want to let their veggies have all the fun! Its high phosphorus formula is designed to bring out buds, blooms and beauty in your spring and summer gardens. Of course it's also got all of the other high quality and blend fortifying ingredients you've come to expect from Down To Earth!



Item #	Desc	UPC	Vendor	CS/UOS	Location
82390162	1 lb	714360178650	17865	12/12	National
82390165	5 lb	714360078653	07865	6/6	National



Acid Mix 4-3-6

Acid Mix is a fertilizer blended for plants that thrive in a low pH soil like blueberries and raspberries, rhododendrons, azaleas, hydrangeas, evergreen trees and shrubs. To encourage lush flowers and fruit, apply in early spring for vegetative growth and again when blooms appear. Fall applications promote root growth and boost resistance to extreme winter temperatures.

Item #	Desc	UPC	Vendor	CS/UOS	Location
82390110	1 lb	714360178032	17803	12/12	National
82390052	5 lb	714360078240	07824	6/6	National
82390100	15 lb	714360158249	15824	1/1	National
82390035	25 lb	714360032273	03227	1/1	National
82390036	50 lb	714360032303	03230	1/1	National

Fruit Tree 6-2-4



Fruit Tree is designed for the delicious and nutritious tree fruits now popular in many backyard gardens. Fruit Tree fertilizer provides primary nutrients for plant growth plus added calcium for proper fruit development, so you can enjoy bountiful crops of home grown fruit. From apples, pears and plums to mangos, pomegranates and figs, Fruit Tree can be used on all varieties of fruiting canes, shrubs and trees.

Item #	Desc	UPC	Vendor	CS/UOS	Location
82390060	5 lb	714360078493	07849	6/6	National
82390101	15 lb	714360158492	15849	1/1	National
82390026	25 lb	714360025497	02549	1/1	West
82390046	50 lb	714360052493	05249	1/1	West

All Purpose 4-6-2



All Purpose mix is ideal for all types of transplants. A gentle, non-burning fertilizer made for vegetables, herbs, flowers and container plants, it is formulated with top-quality organic ingredients and designed to deliver a steady supply of essential nutrients to your plants while enhancing soil fertility and microbial activity naturally.

Item #	Desc	UPC	Vendor	CS/UOS	Location
82390108	1 lb	714360178018	17801	12/12	National
82390048	5 lb	714360078066	07806	6/6	National
82390098	15 lb	714360158065	15806	1/1	National
82390015	25 lb	714360019427	01942	1/1	National

Bio-Live® 5-4-2



Bio-Live is a rich, organic fertilizer featuring a unique blend of premium marine byproducts infused with a diverse mixture of beneficial microorganisms that improve resource utilization and enhance nutrient uptake. Select mycorrhizal fungi and bacterial species rapidly colonize the rhizosphere and surrounding soil.

Item #	Desc	UPC	Vendor	CS/UOS	Location
82390055	5 lb	714360078288	07828	6/6	National
82390011	25 lb	714360019243	01924	1/1	National
82390012	50 lb	714360019250	01925	1/1	National

Vegetable Garden 4-4-4



Vegetable Garden is full of powerful plant nutrition to help your garden grow! Its all-purpose formulation provides a perfect start for your sprightly spring veggies, gives your summer tomatoes super-powers and is fantastic for growing your favorite fragrant herbs. Vegetable Garden's broad nutrient profile is ideal for use throughout the growing season. Grow and eat your veggies!

Item #	Desc	UPC	Vendor	CS/UOS	Location
82390116	1 lb	714360178544	17854	12/12	National
82390063	5 lb	714360078547	07854	6/6	National
82390102	15 lb	714360158546	15854	1/1	National
82390003	25 lb	714360012541	01254	1/1	National
82390047	50 lb	714360052547	05254	1/1	West

Citrus Mix 6-3-3



Citrus trees are a particularly satisfying compliment to the home garden with their vibrant fruits, fragrant blossoms and appealing glossy foliage. Down To Earth's Citrus Mix is specially formulated with primary and secondary plant nutrients plus selected micronutrients that promote lush new growth, abundant green foliage and bountiful blossoms and fruit.

Item #	Desc	UPC	Vendor	CS/UOS	Location
82390117	1 lb	714360178636	17863	12/12	National
82390067	5 lb	714360078639	07863	6/6	National
82390103	15 lb	714360158638	15863	1/1	National
82390009	25 lb	714360013630	01363	1/1	National
82390010	50 lb	714360015634	01563	1/1	National

2025



Starter Mix 3-3-3

Starter Mix, our starter and transplant formula, is the perfect way to get your delicate young starts and new seedlings in the ground and ready to thrive. In addition to essential primary and secondary plant nutrients we've added a beneficial mix of endomycorrhizal fungi to ensure successful planting, expansive root development and vigorous early growth. Use Starter Mix throughout the growing season when transplanting, preparing seed starting soil mixes and for container grown flowers, herbs and vegetables.



Item #	Desc	UPC	Vendor	CS/UOS	Location
82390115	1 lb	714360178360	17836	12/12	National

Houseplant 8-3-1

Finally! An indoor plant fertilizer you can feel good about giving to your precious plant babies. Plant moms (and dads) can rejoice knowing that these powerful little pellets contain an abundance of primary plant nutrients and are perfect for those green beauties hanging out around the house. From Aloes to ZZ plants, our Houseplant fertilizer is specially designed to feed them all. Easy to use and quick to dissolve, its all-purpose formula is ideal for keeping your beloved indoor plants green, growing, and looking their best.



Item #	Desc	UPC	Vendor	CS/UOS	Location
82390151	0.5 lb	714360178315	17831	12/12	National

Rose & Flower Mix 4-8-4

Rose & Flower Mix is outstanding for all types of roses, bulbs, flowering shrubs and even onions and garlic. Apply when planting new roses, bulbs and perennials and use throughout the season when new growth appears on existing plants.



Item #	Desc	UPC	Vendor	CS/UOS	Location
82390109	1 lb	714360178025	17802	12/12	National
82390050	5 lb	714360078202	07820	6/6	National
82390099	15 lb	714360158201	15820	1/1	National
82390133	25 lb	714360324224	32422	1/1	National
82390037	50 lb	714360032426	03242	1/1	National

Palm Tree 6-2-8



Palm Tree is specially formulated to feed all varieties of palms and cycads with the essential macro and micronutrients they need to thrive in outdoor spaces. Whether in tropical or subtropical landscapes, palms add a regal touch and are unparalleled at transforming ordinary backyards into your own small piece of paradise. From the initial selection and design planning, to the planting, watering and fertilization, palms of all species need care and attention to ensure success.

Item #	Desc	UPC	Vendor	CS/UOS	Location
82390069	5 lb	714360078684	07868	6/6	National

Cactus & Succulent 2-4-8

Cactus & Succulent is a blended fertilizer specially designed to support the keystone plants commonly found in arid climate gardens and water-wise xeriscapes. This robust blend of natural and organic ingredients will supply succulents of all types, including cactuses and agaves, with the nutritional backbone to keep them growing strong and producing beautiful blooms.



Item #	Desc	UPC	Vendor	CS/UOS	Location
82390119	1 lb	714360178780	17878	12/12	National
82390074	5 lb	714360078783	07878	6/6	National

LIQUID FERTILIZER

Liquid Fish & Kelp 2-4-1

Liquid Fish & Kelp is an all-purpose natural-based liquid fertilizer made from hydrolyzed fish protein and a concentrated extract of cold water Ascophyllum nodosum seaweed. It is an ideal option for all types of vegetables, herbs, fruits, vines and ornamentals. Liquid Fish & Kelp provides three plant macronutrients for vigorous and productive plants.



Item #	Desc	UPC	Vendor	CS/UOS	Location
82390092	1 qt Concentrate	714360132416	13241	12/12	National

Liquid Bloom™ 2-6-4

This easy to use concentrated liquid formula provides primary and secondary nutrients needed for beautiful blooms while sustaining overall plant growth. Use Liquid Bloom throughout the growing season to support the natural progression of plant development for prolific flowers, flavorful fruits and a wonderful harvest.



Item #	Desc	UPC	Vendor	CS/UOS	Location
82390093	1 qt Concentrate	714360132645	13264	10/10	National



BIOLOGICALS

Soluble Root Zone

Soluble Root Zone is a powerful blend of beneficial soil organisms that colonize plant roots and expand into the surrounding soil to greatly increase the absorptive surface area of root systems. Our new professional grade and ultra-concentrated formula of mycorrhizal fungi, Trichoderma and a diverse mix of bacterial species work symbiotically to promote enhanced activity in the rhizosphere, improved soil structure and extensive root growth.



Item #	Desc	UPC	Vendor	CS/UOS	Location
82390143	4 oz	714360366040	36604	12/12	National

Granular Root Zone

Granular Root Zone is a powerful blend of beneficial soil organisms that colonize plant roots and expand into the surrounding soil to greatly increase the absorptive surface area of root systems. Our new professional grade and ultra-concentrated formula of mycorrhizal fungi, Trichoderma and a diverse mix of bacterial species work symbiotically to promote enhanced activity in the rhizosphere, improved soil structure and extensive root growth.



Item #	Desc	UPC	Vendor	CS/UOS	Location
82390139	2 oz	714360361021	36102	24/24	National
82390140	8 oz	714360361083	36108	12/12	National

WETTABLE POWDERS

Gypsum

Gypsum is composed of calcium (Ca) and sulfur (S) – two of the essential nutrients that plants require to achieve optimum growth and reach their maximum potential. Gypsum offers many advantages for soil management practices in addition to being a valuable resource for plant fertility programs. We offer a high performance solution grade powder that growers can apply with confidence.



Designed for efficient delivery and immediate uptake, this 325 mesh powder can be used in reservoirs, fertigation, drip irrigation or spray applications.

Item #	Desc	UPC	Vendor	CS/UOS	Location
82390121	1 lb	714360190218	19021	6/6	West
82390104	5 lb	714360159215	15921	5/5	West

Fish Bone Powder 4-20-0

Fish Bone Powder is a high quality, free flowing phosphate fertilizer for supplementing plant nutrient requirements or correcting deficiencies in all types of plants including vegetables, flowers, herbs, trees, shrubs and vines. It is derived from fish bone using an advanced enzymatic hydrolysis process and ground to a fine powder for easy and uniform application. Phosphate is an essential nutrient for growing plants and an adequate seasonal supply encourages plenty of buds, flowers, fruits and vegetables.



Item #	Desc	UPC	Vendor	CS/UOS	Location
82390088	1 lb	714360122417	12241	6/6	West
82390089	5 lb	714360122455	12245	5/5	National

Potassium Sulfate

Potassium Sulfate contains potassium (K) and sulfur (S) – two of the essential nutrients that plants require to achieve optimum growth and reach their maximum potential. Nearly every major plant physiological function depends on one or both of these nutrients and here, in the highly available water-soluble sulfate form, we offer a high performance solution grade powder that growers can apply with confidence.



Designed for efficient delivery and immediate uptake, this 200 mesh powder can be used in reservoirs, fertigation, drip irrigation or spray applications.

Item #	Desc	UPC	Vendor	CS/UOS	Location
82390123	1 lb	714360190508	19050	6/6	National

Calcium 96

Ultra fine and highly reactive, Calcium 96 is a natural limestone powder that provides immediate availability of this valuable nutrient for plants and microflora. With a high neutralizing value, this solution grade powder can be applied at rates lower than typical Ag lime for fast soil pH changes. High quality calcium provides a myriad of benefits to plants, soils and soil biology. Designed for efficient delivery and immediate uptake, this 325 mesh powder can be used in drip irrigation or spray applications.



Item #	Desc	UPC	Vendor	CS/UOS	Location
82390124	1 lb	714360190966	19096	6/6	West
82390107	5 lb	714360159963	15996	5/5	West



Natural Wonder® Fruit Tree Fertilizer 5-5-2

Natural Wonder® fertilizer is formulated to feed all fruit trees, berries, and fruiting vines in containers or any backyard soils. It can be used during the initial transplanting after digging the hole or anytime of the year to feed actively growing fruit trees and vines.

Item #	Desc	UPC	Vendor	CS/UOS	Location
81160146	1 lb	749688706568	70656	12/12	West
81160132	12 lb	749688090124	713	5/5	West
81160170	25 lb	749688250092	735	1/1	West

Premium Gold® All Purpose Fertilizer 4-4-4

Premium Gold® All Purpose Fertilizer produces remarkable result. Nutrients are released immediately and over several months. Premium formula provides optimum nutrition. Plants don't lie – it's great for every plant in the garden!

Item #	Desc	UPC	Vendor	CS/UOS	Location
81160147	1 lb	749688708579	70857	12/12	West
81160133	12 lb	749688916875	712	5/5	West
81160171	25 lb	749688250078	734	1/1	West

Annual Bloom Flower Garden Fertilizer 3-7-4

Annual Bloom® Flower Garden Fertilizer is formulated for all flowering plants, containerized or in-ground. Use when planting seeds, transplanting established plants, and periodically throughout year – as needed.

Item #	Desc	UPC	Vendor	CS/UOS	Location
81160188	4 lb	749688928557	705p	12/12	West

Exotic Blend® Palm, Tropical & Hibiscus Fertilizer 5-4-6

Exotic Blend® dry fertilizer has been carefully designed for exotic plants such as palm, hibiscus, ferns, and tropical varieties. You'll get remarkable results and larger, natural blooms. We utilize a proven scientific formula that provides optimal levels of plant nutrition for stunning results.



Item #	Desc	UPC	Vendor	CS/UOS	Location
81160141	1 lb	749688750646	75064	12/12	West
81160190	4 lb	749688314138	756P	12/12	West

Life All Purpose Fertilizer 4-6-5

100% organic & natural hand crafted blend. Ideal for organic vegetable gardens. No GMOs, chicken manure, sewage sludge ("Bio solids") to taint the cleanliness or safety of our handcrafted blend.

Item #	Desc	UPC	Vendor	CS/UOS	Location
81160145	1 lb	749688711647	71164	12/12	West

Root Zone® Starter Fertilizer 2-4-2

Root Zone® fertilizer is formulated to feed all transplants, vegetable garden plants, both summer and winter plants, in containers or in native soil found in your yard. It is best used when planting seeds or transplanting anything into a new container or at home in the garden.

Item #	Desc	UPC	Vendor	CS/UOS	Location
81160148	1 lb	749688711159	71115	12/12	West

Sweet & Sour® Citrus Fertilizer 6-3-3

Sweet & Sour® fertilizer is formulated to feed all fruit trees, berries, and fruiting vines in containers or any backyard soils. It can be used during the initial transplanting after digging the hole or anytime of the year to feed actively growing fruit trees and vines.

Item #	Desc	UPC	Vendor	CS/UOS	Location
81160149	1 lb	749688009003	900	12/12	West

Lawn and Garden Fertilizer 5-0-2

Our nitrogen fertilizer promotes lush, green growth and long term nutrition for lawns, vegetables, flowers, trees, shrubs, annuals, and perennials. A true organic, pelletized all purpose fertilizer that produces remarkable results because nutrients are released quickly yet continue to feed for several months. Ultra-premium scientific formula provides optimum levels of primary essential plant nutrients. TruBiotic ensures organic nutrients are thoroughly broken down then released in the soil for plant roots to absorb them as they are needed. Feeds for several months.



Item #	Desc	UPC	Vendor	CS/UOS	Location
81160137	18 lb	749688646994	699	1/1	West



Blood Meal 13-0-0

Premium kiln-dried Blood Meal is an excellent source of organic nitrogen that promotes growth in all types of plants. It contains Superactive soil and seed inoculant and 5 strains of beneficial soil microbes. TruBiotic ensures organic nutrients are thoroughly broken down and then released in the soil for plant roots to absorb them as they are needed, contributing to drought tolerance, enhanced nutrient availability and increased plant performance. As an added bonus, it helps to repel deer! Use on vegetables, roses and flowers, trees and shrubs, container plants, tropical plants and all plants in vegetative growth. Can be used as a fertilizer tea to feed plants.

Item #	Desc	UPC	Vendor	CS/UOS	Location
81160116	2 lb	749688077712	716	12/12	West

Kelp Meal 1-0.05-2

Kelp Meal with cold water Norwegian kelp is an excellent source of potash and promotes health in all planting applications. Contains minerals, growth regulators, vitamins, hormones, and enzymes. Infused with TruBiotic which ensures organic nutrients are thoroughly broken down and then released in the soil for plant roots to absorb them as they are needed, contributing to drought tolerance, enhanced nutrient availability and increased plant performance.

Item #	Desc	UPC	Vendor	CS/UOS	Location
81160173	2.5 lb	749688077767	725	12/12	West

Alfalfa Meal 2-1-2

Alfalfa Meal is fast acting and excellent source of Magnesium - which roses love. It contains natural growth stimulant Triaccontanol which boosts growth of all plant types. TruBiotic which ensures organic nutrients are thoroughly broken down and then released in the soil for plant roots to absorb them as they are needed, contributing to drought tolerance, enhanced nutrient availability and increased plant performance.

Item #	Desc	UPC	Vendor	CS/UOS	Location
81160181	3 lb	749688077736	720	12/12	West

Compost Starter

Compost Starter produces remarkable results because it significantly speeds up the decomposition of raw organic materials to create true organic humus. TruBiotic® ensures organic nutrients are thoroughly broken down then released in the compost pile for preparation of soil applications.

Item #	Desc	UPC	Vendor	CS/UOS	Location
81160183	3 lb	749688077118	727	12/12	West

Bone Meal 3-15-0

Bone Meal is an excellent source of organic phosphorous, providing both long term and short term benefits. Great for root and fruit development. It benefits bulbs, flowers, roses, vegetables, all blooming plants, trees and shrubs. It contains Superactive soil and seed inoculant and 5 strains of beneficial soil microbes. TruBiotic ensures organic nutrients are thoroughly broken down and then released in the soil for plant roots to absorb them as they are needed, contributing to drought tolerance, enhanced nutrient availability and increased plant performance.

Item #	Desc	UPC	Vendor	CS/UOS	Location
81160151	2.5 lb	749688077729	718	12/12	West

Fish Bone Meal 3-18-0

Pasteurized Fish Bone Meal is an excellent source of organic phosphorous. It benefits plants in all stages of growth and is especially beneficial for roots, buds and blooms. It contains Superactive soil and seed inoculant and 5 strains of beneficial soil microbes. TruBiotic ensures organic nutrients are thoroughly broken down and then released in the soil for plant roots to absorb them as they are needed, contributing to drought tolerance, enhanced nutrient availability and increased plant performance.

Item #	Desc	UPC	Vendor	CS/UOS	Location
81160152	2.5 lb	749688077774	722	12/12	West

Total Advantage® Rose & Flower Fertilizer 4-6-2

Dr. Earth® Total Advantage® Rose & Flower Fertilizer is formulated to feed flowering plants naturally to promote bigger and more abundant blooms. Dr. Earth® Total Advantage® Rose & Flower Fertilizer is great for all roses, flowers, flowering trees, shrubs as well as annuals & perennials.



Item #	Desc	UPC	Vendor	CS/UOS	Location
81160352	24 oz Concentrate	749688410380	1038	12/12	West
81160150	1 lb	749688728553	72855	12/12	West
81160135	12 lb	749688030120	709	5/5	West
81160172	25 lb	749688250030	731	1/1	West



Pure Gold All Purpose Pelletized Fertilizer 2-2-2

Pure Gold is a true pelletized organic all purpose fertilizer that produces remarkable results because nutrients are released quickly yet continue to feed for several months. Ultra-premium scientific formula provides optimum levels of primary essential plant nutrients. TruBiotic ensures organic nutrients are thoroughly broken down then released in the soil for plant roots to absorb them as they are needed. Feeds for several months. Great for every plant in the garden.



Item #	Desc	UPC	Vendor	CS/UOS	Location
81160333	24 oz Concentrate	749688410403	1040	12/12	West
81160335	3 lb	749688007580	758P	12/12	West

Flower Girl® Bud & Bloom Booster Fertilizer

Flower Girl® dry fertilizer produces fantastic results as it releases some nutrients quickly and others may last up to several months. Ultra-premium scientific formula provides measured and optimal plant nutrients for maximum plant health and growth.



Item #	Desc	UPC	Vendor	CS/UOS	Location
81160234	24 oz 1-2-1 Concentrate	749688410410	1041	12/12	West
81160142	1 lb 3-9-4	749688707923	70792	12/12	West
81160192	4 lb 3-9-4	749688803090	707p	12/12	West
81160128	12 lb 3-9-4	749688735216	101	5/5	West

Home Grown® Tomato, Vegetable & Herb Fertilizer

Home Grown® fertilizer is formulated to feed vegetable gardens, summer and winter crops, container plantings or native backyard soil. Use it during initial planting of seeds, transplanting, and on a regular basis as a top dressing or compost tea.



Item #	Desc	UPC	Vendor	CS/UOS	Location
81160257	24 oz 3-2-2 Concentrate	749688410397	1039	12/12	West
81160258	32 oz 3-2-2 RTS	749688410342	1034	12/12	West
81160143	1 lb 4-6-3	749688734165	73416	12/12	West
81160130	12 lb 4-6-3	749688122085	711	5/5	West
81160168	25 lb 4-6-3	749688250054	733	1/1	West



Pump & Grow Cactus & Succulent 1-1-2

Pump & Grow Cactus and Succulent Plant Food, 1-1-2 Fertilizer is a quick and easy to use product to fertilize your indoor and outdoor containers plants. Simply apply two pumps directly to the soil and water within 24 hours and it will feed your plants 100% sustainable nutrients for two weeks. Applying directly to the soil makes gardening easy with no mixing and no mess.

Item #	Desc	UPC	Vendor	CS/UOS	Location
81160309	8 oz	749688410656	1065	12/12	West
81160330	16 oz	749688410779	1077	12/12	West

Home Grown Pump & Grow Organic Tomato & Vegetable Food 3-2-2

Pump & Grow Organic Tomato and Vegetable Food, 3-2-2 Fertilizer is a very quick and easy to use products for your garden and herbs. Simply apply two pumps directly to the soil and water within 24 hours and it will feed your plants 100% sustainable nutrients for two weeks. Applying directly to the soil makes gardening easy with no mixing and no mess.

Item #	Desc	UPC	Vendor	CS/UOS	Location
81160315	8 oz	749688410663	1066	12/12	West
81160314	16 oz	749688410786	1078	12/12	West

Pump & Grow Indoor Plant Food 1-1-1

Pump & Grow Liquid-Concentrate Organic Plant Food 1-1-1 Fertilizer. Simply apply two pumps directly to the soil and water within 24 hours and it will feed your plants 100% sustainable nutrients for two weeks. Applying directly to the soil makes gardening easy with no mixing and no mess.

Item #	Desc	UPC	Vendor	CS/UOS	Location
81160317	8 oz	749688410724	1072	12/12	West
81160316	16 oz	749688410847	1084	12/12	West

Pump & Grow Pure Gold All Purpose 1-1-1

Pump & Grow All Purpose Plant Food, concentrated liquid fertilizers are very quick and easy to use because it can be applied directly to the soil. Simply apply two pumps to the soil and water within 24 hours to feed your plants. 100% sustainable nutrients for 2 weeks. Gardening made easy with no mixing and no mess.

Item #	Desc	UPC	Vendor	CS/UOS	Location
81160325	8 oz	749688410854	1085	12/12	West
81160324	16 oz	749688410861	1086	12/12	West

Acid Lovers® Azalea, Camellia, Rhododendron & Maple Fertilizer 3-4-3

Acid Lovers® dry fertilizer is formulated for acid loving plants. It is ideal for azaleas, camellias, rhododendrons, maples, hollies, gardenias, hydrangeas, blueberries, evergreens, ferns and shade plants. Excellent for use in raised beds during transplanting or feeding mid-season for a nutritional boost.



Item #	Desc	UPC	Vendor	CS/UOS	Location
81160138	1 lb	749688755573	75557	12/12	West
81160186	4 lb	749688121859	703p	12/12	West
81160126	12 lb	749688040129	710	5/5	West
81160167	25 lb	749688250047	732	1/1	West

Pure Gold All Purpose Plant Food 1-1-1

With a balanced NPK of 1-1-1 this is a great fertilizer to feed in the middle of the season. It is free of synthetic ingredients. Sustainably made from the highest level human-grade whole-foods, Dr. Earth upcycles would-be food grade waste from grocery stores and converts it into premium fertilizer, making them the most sustainable source of nutrients you can put in your garden. Comes in an easy to use, hose-end sprayer. Covers 1200 sq.ft.



Item #	Desc	UPC	Vendor	CS/UOS	Location
81160334	32 oz RTS	749688410359	1035	12/12	West



Carefree Christmas Tree Watering Aid

Carefree Christmas Tree helps your tree retain moisture so it looks fresh without watering for up to 4 weeks. Carefree Christmas Tree is all natural, non-toxic. With Carefree Christmas Tree-- water once and done.



Item #	Desc	UPC	Vendor	CS/UOS	Location
82170059	4oz	016069006242	CCT-24	24/24	National

Aerosol TreeKote

Treekote aerosol spray is tree wound dressing. Just apply to fresh pruned areas. It protects your shrubs, bushes, vines, and trees from decay, insects, and fungi.



Item #	Desc	UPC	Vendor	CS/UOS	Location
80470165	12oz	050699002120	300212	12/12	National

Grafting Wax

Treekote grafting wax is a must-have for horticultural professionals. It provides effective protection by sealing wounds and preventing infection in newly grafted trees or shrubs. This wax remains flexible after application, ensuring optimal moisture retention. With easy application, it can be heated to a semi-liquid state and smoothly brushed onto the desired area. Even in the face of rain, Treekote grafting wax is weather-resistant and won't wash away, guaranteeing long-lasting results.



Item #	Desc	UPC	Vendor	CS/UOS	Location
80470167	4oz	050699000140	300014	12/12	National

TreeKote Tree Wound Dressing

Tree wound dressing protects your shrubs, bushes, vines, and trees from decay, insects, and fungi. Apply to fresh pruned areas. Shields tree wounds. Withstands all weather: hot, cold, wet, and dry. For patching damaged areas of trees and shrubbery, tree surgery and grafting. Brushtop plastic container.



Item #	Desc	UPC	Vendor	CS/UOS	Location
80470158	16oz Bottle	050699000164	300016	12/12	National





Evergreen-tone® 4-3-4

Feed in the Spring and late Fall at half the Spring rate for BEAUTIFUL evergreens, pines, conifers & more! 100% natural & organic ingredients with no fillers or sludges. Long lasting, slow-release feeding with our exclusive Bio-tone Microbes plus 5% Calcium, 1% Magnesium & 5% Sulfur. Also for acid loving plants like hydrangeas.

Item #	Desc	UPC	Vendor	CS/UOS	Location
80030215	8 lb.	050197067089	ET8	6/6	National
80030214	18 lb.	050197067188	ET18	1/1	East

Berry-tone® 4-3-4

An all-natural plant food formulated specifically for blueberries, strawberries and raspberries. It is safe, long lasting, slow release nitrogen and will provide the nutrients necessary for bigger fruit growth.

Item #	Desc	UPC	Vendor	CS/UOS	Location
80030187	4 lb.	050197066044	BRT4	12/12	National

Iron-tone® 3-0-3

A premium plant food formulated to correct chlorosis and turn yellow foliage to a deep, dark green color. Iron-tone does not stain concrete, and can be used for plant or lawn applications.

Item #	Desc	UPC	Vendor	CS/UOS	Location
80030065	5 lb.	050197054058	IT5	12/12	National

Palm-tone® 4-1-5

Palm-tone is the result of The Espoma Company's expertise in natural organics combined with recommendations from leading research universities. Palm-tone's all natural formula contains Bio-tone®, the proprietary blend of beneficial microbes. Bio-tone biologically enhances the natural plant food to ensure superior plant growth. **Not For Sale UT, WY**

Item #	Desc	UPC	Vendor	CS/UOS	Location
80030058	4 lb.	050197039048	PM4	12/12	National

Rose-tone® 4-3-2

A premium rose food designed to supply the necessary nutrients for growing prize winning roses. The organics in Rose-tone breakdown gradually providing a safe, long lasting food reservoir activated throughout the growing season. Rose-tone's all natural formula contains Bio-tone®, the proprietary blend of beneficial microbes.

Item #	Desc	UPC	Vendor	CS/UOS	Location
80030021	4 lb.	050197004046	RT4	12/12	National
80030038	8 lb.	050197004084	RT8	6/6	National
80030111	18 lb.	050197004183	RT18	1/1	National

Garden-tone® 3-4-4

An all-natural plant food formulated specifically for vegetable gardens. It is safe, long lasting, and will provide the nutrients necessary for vigorous and productive plants. Garden-tone's all natural formula contains Bio-tone®, our proprietary blend of beneficial microbes. Bio-tone biologically enhances our natural plant food to ensure superior plant growth.

Item #	Desc	UPC	Vendor	CS/UOS	Location
80030018	4 lb.	050197003049	GT4	12/12	National
80030035	8 lb.	050197003087	GT8	6/6	National
80030114	18 lb.	050197003186	GT18	1/1	National
80030113	36 lb.	050197003360	GT36	1/1	East

Plant-tone® 5-3-3

The original all natural plant food made from the finest quality organics available. Plant-tone's natural organics break down gradually, providing a safe, long lasting food reservoir activated throughout the growing season. Plant-tone's all natural formula contains Bio-tone®, the proprietary blend of beneficial microbes. Bio-tone biologically enhances the natural plant food to ensure superior plant growth.

Item #	Desc	UPC	Vendor	CS/UOS	Location
80030020	4 lb.	050197002042	PT4	12/12	National
80030037	8 lb.	050197002080	PT8	6/6	National
80030109	18 lb.	050197002189	PT18	1/1	National
80030108	36 lb.	050197002363	PT36	1/1	East
80030131	50 lb.	050197002509	PT50	1/1	East



Holly-tone® 4-3-4

For acid-loving plants, such as hollies, azaleas, camellias, evergreens, hydrangeas, dogwoods, blueberries, strawberries and rhododendrons. It is rich in natural organics and enhanced with Bio-tone®, our proprietary blend of beneficial microbes. Bio-tone biologically enhances our natural plant food to ensure superior plant growth. Used and recommended by Professionals. **Not For Sale CO**

Item #	Desc	UPC	Vendor	CS/UOS	Location
80030019	4 lb.	050197001045	HT4	12/12	National
80030036	8 lb.	050197001083	HT8	6/6	East
80030107	18 lb.	050197001182	HT18	1/1	East
80030106	36 lb.	050197001366	HT36	1/1	East
80030130	50 lb.	050197001502	HT50	1/1	East

Bulb-tone® 3-5-3

A premium plant food formulated specifically for bulbs and tubers. It contains bone meal and other natural organics to meet the special nutritional needs of these plants. Bulb-tone's all natural formula contains Bio-tone®, the proprietary blend of beneficial microbes. Bulb-tone feeds slowly, safely, and will provide a long lasting food reservoir to ensure superior results. **Not For Sale HI**

Item #	Desc	UPC	Vendor	CS/UOS	Location
80030015	4 lb.	050197006040	BT4	12/12	National
80030112	18 lb.	050197006187	BT18	1/1	East

Tree-tone® 6-3-2

A premium plant food formulated specifically for shade, fruit, and ornamental trees. Tree-tone's all natural formula contains Bio-tone®, our proprietary blend of beneficial microbes. Bio-tone biologically enhances our natural plant food to ensure superior plant growth. The natural organics in Tree-tone break down gradually to provide a safe, long lasting nutrient reservoir to feed the entire tree: leaves, trunk, and roots. **Not For Sale HI**

Item #	Desc	UPC	Vendor	CS/UOS	Location
80030023	4 lb.	050197007047	TR4	12/12	National
80030118	18 lb.	050197007184	TR18	1/1	National
80030117	36 lb.	050197007368	TR36	1/1	East

Flower-tone® 3-4-5

A premium flower food that is low in nitrogen and higher in phosphorous and potassium to maintain good plant growth and promote blooms rather than heavy foliage. Flower-tone's natural organics breakdown gradually providing a safe, long lasting food reservoir activated throughout the growing season. Flower-tone's all natural formula contains Bio-tone®, the proprietary blend of beneficial microbes. Bio-tone biologically enhances the natural plant food to ensure superior plant growth. **Not For Sale HI**

Item #	Desc	UPC	Vendor	CS/UOS	Location
80030017	4 lb.	050197029049	FT 4	12/12	National
80030110	18 lb.	050197029186	FT18	1/1	National

Citrus-tone® 5-2-6

Citrus-tone's all natural formula contains Bio-tone®, our proprietary blend of beneficial microbes. Bio-tone® biologically enhances our natural plant food to ensure superior plant growth.

Item #	Desc	UPC	Vendor	CS/UOS	Location
80030016	4 lb.	050197050043	CT4	12/12	National
80030056	8 lb.	050197050081	CT8	6/6	West
80030119	18 lb.	050197050180	CT18	1/1	National

Azalea-tone® 4-3-4

Long lasting, slow release for better blooms and foliage. Ideal for Azalea, Camellia, Gardenia & Rhododendron.

Item #	Desc	UPC	Vendor	CS/UOS	Location
80030173	4 lb.	050197065047	AT4	12/12	National
80030172	8 lb.	050197065085	AT8	6/6	National
80030202	18 lb.	050197065184	AT18	1/1	National

Garden Food 10-10-10

A general purpose garden food that provides the three major nutrients in equal amounts. Promotes vigorous growth in all flowering plants and vegetables. **Not For Sale CA, NV, UT**

Item #	Desc	UPC	Vendor	CS/UOS	Location
80030031	6.75 lb.	050197028066	GF101010/6	6/6	National



Kelp Meal 1-0-2

Kelp Meal is brown seaweed harvested from the cold, nutrient-rich waters of the north Atlantic Ocean. Espoma® Kelp Meal, *Ascophyllum nodosum*, is the best species of kelp for both horticultural and agricultural use. Espoma® Kelp Meal is approved for organic gardening. **Not For Sale AZ, NV, UT**

Item #	Desc	UPC	Vendor	CS/UOS	Location
80030072	4 lb.	050197027045	KM4	12/12	National

Garden Food 5-10-5

An agricultural grade all purpose plant food that helps plants quickly absorb nutrients. Less Nitrogen and Potassium than 10-10-10. For use on flowers, vegetables, trees and shrubs. **Not For Sale CA, CO, ID, MT, NV, UT, WY**

Item #	Desc	UPC	Vendor	CS/UOS	Location
80030032	6.75 lb.	050197019064	GF5105/6	6/6	National

Bone Meal 4-12-0

An all natural organic source of Nitrogen and Phosphorus. Bone Meal helps develop sturdy root systems, promotes plant growth, and is ideal as a supplement for bulbs, flowers and roses.

Item #	Desc	UPC	Vendor	CS/UOS	Location
80030179	4 lb.	050197010092	BM04	12/12	National
80030226	8 lb.	050197010085	BM8	6/6	National
80030070	10 lb.	050197010108	BM10	6/6	National
80030069	24 lb.	050197010245	BM24	1/1	East

Rock Phosphate

Organic rock phosphate provides phosphorous for all flowering plants. All natural and pelletized for easy application. Contains 3 percent available and 24 percent total phosphate. Promotes root growth. Mined from phosphorous rich natural deposits. Used as a soil conditioner. Carrying a formulation of 0-3-0. Comes in 7.25-pound bag. **Not For Sale CA, CO, MT, NV, OR, UT, WY**



Item #	Desc	UPC	Vendor	CS/UOS	Location
80030077	7.25 lb.	050197012072	RP7	6/6	National

Bio-tone® Starter Plus 4-3-3

Bio-tone® Starter Plus is an all-natural plant food that is made with a stronger concentration of beneficial bacteria and Mycorrhizae. The ideal starter plant food, originally designed for professionals. Bio-tone® Starter Plus will increase root mass and help avoid transplant loss. This is the only Espoma Tone that contains Mycorrhizae.

Not For Sale HI

Item #	Desc	UPC	Vendor	CS/UOS	Location
80030062	5 oz.	050197038027	BTSP5OZ	80/80	National
80030014	4 lb.	050197038041	BTSP4	12/12	National
80030132	8 lb.	050197038089	BTSP8	6/6	National
80030121	18 lb.	050197038188	BTSP18	1/1	National
80030059	25 lb.	050197038256	BTSP25	1/1	National

Triple Phosphate 0-45-0

An enriched source of Phosphorus which helps with flower and fruit formation as well as root growth. For use on flowers, vegetables, trees and shrubs. **Not For Sale CA, NV, PR**

Item #	Desc	UPC	Vendor	CS/UOS	Location
80030103	6.5 lb.	050197016063	TP6	6/6	National

Tomato-tone® 3-4-6

A premium plant food formulated specifically for growing plump and juicy tomatoes. Tomato-tone's organic composition feeds your plants naturally and will not force rapid growth at the expense of blooms and tomato yield. Tomato-tone's all natural formula contains Bio-tone® that biologically enhances the natural plant food to ensure superior plant growth. Enhanced with 8% calcium to help prevent blossom end rot.

Not For Sale HI

Item #	Desc	UPC	Vendor	CS/UOS	Location
80030022	4 lb.	050197009041	TO4	12/12	National
80030053	4 lb. Display	050197009041	TO4MP	90/90	National
80030052	8 lb.	050197009089	TO8	6/6	National
80030115	18 lb.	050197009188	TO18	1/1	National

Blood Meal 12-0-0

An all natural organic source of nitrogen. Blood Meal promotes rapid growth and deep, dark green color, and is an ideal supplement for all annuals and perennials. A time proven remedy for sickly plants.

Item #	Desc	UPC	Vendor	CS/UOS	Location
80030180	3 lb.	050197013093	DB03	12/12	National
80030073	17 lb.	050197013178	DB17	1/1	East



Chicken Manure 5-2-3

All natural poultry manure approved for organic gardening. Dehydrated and granulated for easy application.



Item #	Desc	UPC	Vendor	CS/UOS	Location
80030149	3.75 lb.	050197018036	GM3	12/12	National
80030148	25 lb.	050197018258	GM25	1/1	National

Cow Manure Compost Blend

A Blend of Dehydrated Cow Maure and Compost for Lawn and Garden.

Not For Sale AK, AZ, CA, HI, NV, NM



Item #	Desc	UPC	Vendor	CS/UOS	Location
80030200	1 cu ft	050197716017	DCM1	65/10	East

Compost Starter

Formulated to accelerate the process of home composting materials including manure, grass, leaves and food waste. Compost Starter contains billions of microbes specially culture to speed the decomposition of difficult to compost organic matter. These are combined with the proper energy sources and pH balancer's to assure composting success.



Item #	Desc	UPC	Vendor	CS/UOS	Location
80030080	4 lb.	050197023047	CS4	12/12	National

Soil PerfeCTOR

Soil PerfeCTOR is made from a naturally derived, ceramic mineral that is kiln-fired at temperatures in excess of 2000° F. This process creates a durable, lightweight granule containing thousands of tiny storage spaces that hold the perfect balance of water, air and nutrients for an improved soil structure.



Item #	Desc	UPC	Vendor	CS/UOS	Location
80030138	30 lb	050197034302	SPF30	1/1	East

Potash 0-0-60

Source of high Potassium promotes plant vigor. An enriched source of Potassium. Granular for easy application. Promotes plant vigor and disease resistance. Use on flowers, vegetables, trees & shrubs. Made with solar power. **Not For Sale CA, NV**



Item #	Desc	UPC	Vendor	CS/UOS	Location
80030105	6 lb.	050197017060	PO6	6/6	East

Tomato! 1-3-1

Organic liquid plant food ideal for tomatoes and vegetables. Produces plump, juicy tomatoes.

Not For Sale HI



Item #	Desc	UPC	Vendor	CS/UOS	Location
80030218	8 oz.	050197313087	TOPF8	6/6	National
80030222	16 oz.	50197313162	TOPF16	6/6	National

Alfalfa Meal 2-0-2

Alfalfa Meal is formulated with all natural, quality ingredients promoting vigorous growth and abundant blooms. Specially designed for use with roses, flowers, vegetables, trees, shrubs and more. Conveniently use alone or use to make a liquid fertilizer tea.



Item #	Desc	UPC	Vendor	CS/UOS	Location
80030150	3 lb.	050197062039	AL3	12/12	East

Bloom! 1-3-1

Bloom! Liquid Plant Food promotes flowers and fruit in all indoor and outdoor flowering plants, including hanging baskets. Espoma Bloom! is approved for organic gardening. **Not For Sale HI**

Item #	Desc	UPC	Vendor	CS/UOS	Location
80030220	16 oz.	50197304160	BL16	6/6	National

Grow! 2-2-2

Espoma organic indoor plant food is specially formulated with organic ingredients, all major plant nutrients & millions of beneficial microbes delivering optimum plant health & top performance results. For both outdoor and indoor use. **Not For Sale HI**

Item #	Desc	UPC	Vendor	CS/UOS	Location
80030221	16 oz.	50197303163	GR16	6/6	National



Bio-tone® Starter 4-3-3

Granular Bio-tone® starter is microbe enhanced all natural plant food. Contains an active community of living microbes blended with humates. Promotes faster establishment, deeper roots and a superior soil structure. **Not For Sale AZ, CA, HI**



Item #	Desc	UPC	Vendor	CS/UOS	Location
80030063	25lb.	050197035255	BTSG25	1/1	East

Big Bloom 0-0.5-0.7

FoxFarm's Big Bloom® Liquid Plant Food is a carefully selected blend of fertilizers formulated to support multiple blooms and seed formations. This liquid plant food supplies nutrients that your plants can access immediately. OMRI Listed® and Registered CDFCA Organic Input Material.



Item #	Desc	UPC	Vendor	CS/UOS	Location
82000108	1 pt	752289793103	BBPINT	12/12	National
82000068	1 qt	752289790102	BBQT	12/12	National
82000095	1 gal	752289790904	BBGAL	4/4	National
82000096	2.5 gal	752289790911	BB2.5GAL	2/2	East

2025



Grow Big 6-4-4

Liquid Concentrate Fertilizer with Micronutrients. Get your garden going with Grow Big®, a liquid plant food that supports lush, vegetative growth.



Item #	Desc	UPC	Vendor	CS/UOS	Location
82000109	1 pt 6-4-4	752289793202	GBPINT	12/12	National
82000069	1 qt 6-4-4	752289790201	GBQT	12/12	National
82000070	1 qt Hydroponic 3-2-6	752289790218	GBHQT	12/12	National
82000075	1 gal 6-4-4	752289790300	GBGAL	4/4	National
82000076	2.5 gal	752289790317	GB2.5GAL	2/2	National



Dirty Dozen Starter Kit

Three 6-Ounce Solubles: Open Sesame®, Beastie Bloomz®, & Cha Ching®. Nine Pint Liquids: Kangaroots®, Microbe Brew®, Bembé®, SledgeHammer®, Cultivation Nation® Cal-Mag, Boomerang®, Big Bloom®, Tiger Bloom®, and Grow Big®.

Item #	Desc	UPC	Vendor	CS/UOS	Location
82000039	Starter Kit	752289301209	DIRTYDOZEN	2/2	National

Tiger Bloom 2-8-4

Tiger Bloom® is a phosphorus fertilizer that contains nitrogen to support vigorous growth. Tiger Bloom® is designed to encourage abundant fruit, flower and multiple bud development.



Item #	Desc	UPC	Vendor	CS/UOS	Location
82000111	1 pt	752289793226	TBPINT	12/12	National
82000071	1 qt	752289790225	TBQT	12/12	National
82000077	1 gal	752289790324	TBGAL	4/4	National



Cha Ching 9-50-10

For Late Flowering Through Harvest. Cha Ching® is a high-phosphorus fertilizer that is designed to help support late stage fruiting processes.



Item #	Desc	UPC	Vendor	CS/UOS	Location
82000057	6 oz	752289501333	CC6OZ	24/24	National
82000051	1 lb	752289501432	CC1.0	12/12	National
82000053	2 lb	752289501531	CC2.0	12/12	National
82000054	15 lb	752289501548	CC15	1/1	National

Beastie Bloomz 0-50-30

Beastie Bloomz® is a high-phosphorus soluble fertilizer specially formulated to support blossom development during mid to late flowering. For use in soilless mixes, soils, hydroponics, and aeroponic systems.



Item #	Desc	UPC	Vendor	CS/UOS	Location
82000049	6 oz	752289501319	BBZ6OZ	24/24	National
82000050	1 lb	752289501418	BBZ1.0	12/12	National

CULTIVATION NATION



Item #	Desc	UPC	Vendor	CS/UOS	Location
82000193	Veggie - 1 lb	752289260629	CNVEGGIE1.0	12/12	National
82000176	Grow - 1 qt	752289260186	CNGROWQT	12/12	National
82000182	Micro - 1 qt Not For Sale ND	752289260223	CNMICROQT	12/12	National
82000188	Bloom - 1 qt	752289260261	CNBLOOMQT	12/12	National
82000215	Ph Down - 1 qt Not For Sale ID, MN	752289270147	CNPHDQT	12/12	National
82000218	Ph Up - 1 qt	752289270116	CNPHUQT	12/12	National
82000214	Ph Down - 1 pnt Not For Sale ID, MN	752289270130	CNPHDPINT	12/12	National
82000217	Ph Up - 1 pnt	752289270109	CNPHUPINT	12/12	National

Open Sesame 5-45-19

For Early Flowering Stage. Open Sesame® is a blend of nutrients specifically designed for use during the early weeks of flowering. Open Sesame® supports vigorous flowering and bud development. Use in soilless mixes, soils, hydroponics and aeroponic systems.



Item #	Desc	UPC	Vendor	CS/UOS	Location
82000005	6 oz	752289201530	OS6OZ	24/24	National
82000006	1 lb	752289201639	OS1.0	12/12	National

Soil Trio Pack



Hydroponic Trio Pack



Trio Pack

Trio Pack features one each: Big Bloom quart, Grow Big quart, Tiger Bloom quart (4 trio packs per case)

Item #	Desc	UPC	Vendor	CS/UOS	Location
82000100	Soil Trio Pack	752289791000	LSTP	4/4	National
82000107	Hydroponic Trio Pack	752289792007	LHTP	4/4	National

Marine Cuisine 10-7-7

Seafood for Your Garden!

Marine Cuisine® is an all-purpose fertilizer that blends ocean-based ingredients like crab meal, shrimp meal, seabird guano, and kelp with mineral plant foods to give your garden a quick boost and provide long-lasting, slow release nutrition.



Item #	Desc	UPC	Vendor	CS/UOS	Location
82000081	4 lb	752289790393	MC4	8/8	National
82000083	50 lb	752289790430	MC50	1/1	National

Happy Frog All Purpose Dry Fertilizer

Happy Frog All-Purpose Fertilizer is a ready-to-use blend of natural fertilizers and microorganisms that deliver nutrition where your plants need it most. Highly recommended for vegetable gardens, annual and perennial flower gardens, ornamental plantings, and all types of container gardening. **Not For Sale HI**



Item #	Desc	UPC	Vendor	CS/UOS	Location
82000066	50 lb	752289600555	HFALLPURP50	1/1	National



HAPPY FROG FERTILIZER



***Not For Sale HI**

Item #	Desc	UPC	Vendor	CS/UOS	Location
82000046	Acid Loving Dry Fert 4 lb bag 4-5-3: Designed for Low pH Lovers	752289500626	HFACID4	12/12	National
82000042	All Purpose Dry Fert 4 lb bag 6-4-5: Flowers, Vegetables and Ornamentals	752289500541	HFALLPURP4	12/12	National
82000045	Citrus & Avocado Dry Fert 4lb bag 7-3-3: Formulated for Citrus and Avocado Trees	752289500602	HFCITAVO4	12/12	National
82000041	Fruit & Flower Dry Fert 4 lb bag 4-9-3: Supports Abundant Fruiting & Flowering	752289500527	HFFNF4	12/12	National
82000043	Japanese Maple Dry Fert 4 lb bag 4-3-4: Helps Encourage Dense Vegetative Growth	752289500565	HFJAP4	12/12	National
82000044	Jump Start Dry Fert 4 lb bag 3-4-3: For Transplant Seedlings and Re-Potted Plants	752289500589	HFJUMP4	12/12	National
82000047	Steamed Bone Meal Dry Fert 4lb bag 3-12-0: Provides Phosphorus at all Stages of Growth	752289500640	HFBONE4	12/12	National
82000040	Tomato & Vegetable Dry Fert 4lb bag 5-7-3: Designed for Vigorous Feeders	752289500503	HFTV4	12/12	National
82000048	Cavern Culture Dry Fert 4 lb bag 1-12-0: Bat Guano, Seabird Guano and Rock Phosphate	752289500664	HFCC4	12/12	National

BUSH DOCTOR FERTILIZER



Item #	Desc	UPC	Vendor	CS/UOS	Location
82000114	SledgeHammer 1 pt Nutrient Rinse - Encourages Water Movement - Removes Buildup	752289793806	SHPINT	12/12	National
82000091	SledgeHammer 1 qt Nutrient Rinse - Encourages Water Movement - Removes Buildup	752289790805	SHQT	12/12	National
82000117	Bembé 1 pt 0-1-3: Enhance Sweetness - Created with a Complex Array of Sugars & Nutrients Not For Sale IL	752289794056	BEMPINT	12/12	National
82000115	Boomerang 1 pt 2-0.2-0.3: Supports Root Zone "Comeback Formula" Not For Sale HI	752289793851	BRPINT	12/12	National
82000093	Boomerang 1 qt 2-0.2-0.3: Supports Root Zone "Comeback Formula" Not For Sale HI	752289790850	BRQT	12/12	National
82000113	Kangaroots 1 pt 0.8-0.1-0.03: Enhances Root Efficiency in the Rhizosphere Not For Sale HI, IL	752289793769	KRPINT	12/12	National
82000089	Kangaroots 1 qt 0.8-0.1-0.03: Enhances Root Efficiency in the Rhizosphere Not For Sale HI, IL	752289790768	KRQT	12/12	National
82000118	Kelp Me Kelp You 1 pt 0.5-0-0.5: Seaweed Plant Food	752289794209	KMKYPINT	12/12	National
82000103	Kelp Me Kelp You 1 qt 0.5-0-0.5: Seaweed Plant Food	752289791208	KMKYQT	12/12	National
82000112	Microbe Brew 1 pt 1-0.3-0.2: Microbe Plant Food - Enhance Nutrient Uptake Not For Sale HI, IL	752289793714	MBPINT	12/12	National
82000087	Microbe Brew 1 qt 1-0.3-0.2: Microbe Plant Food - Enhance Nutrient Uptake Not For Sale HI, IL	752289790713	MBQT	12/12	National
82000119	Wholly Mackerel 1 pt 3-1-0: Fish Fertilizer - Supports Vigorous Growth	752289794308	WMPINT	12/12	National
82000105	Wholly Mackerel 1 qt 3-1-0: Fish Fertilizer - Supports Vigorous Growth	752289791307	WMQT	12/12	National
82000211	CAL-MAG 1 pt OMRI Listed Strengthen Cell Walls And Aid In Fruit Development	752289520075	BDCALMAGPINT	12/12	National
82000212	CAL-MAG 1 qt OMRI Listed Strengthen Cell Walls And Aid In Fruit Development	752289520082	BDCALMAGQT	12/12	National



Gardener's Special Plant Food 11-15-11

Gardener Special contains both fast and slow release nitrogen, plus the necessary trace elements to help promote plant development. For use on vegetables roses, flowers, trees and shrubs. **Not For Sale CA, DE, HI, MD, ME, ND, PR, RI, VI, VT, WI**

Item #	Desc	UPC	Vendor	CS/UOS	Location
82280062	4 lb	732221107854	10784	12/12	National

All Purpose Water Soluble Plant Food 20-20-20

This 20-20-20 plant food is ideal for all potted plants. Works best when used as a soil drench combined with a foliar spray. **Not For Sale AK, HI, PR, VI, WI**

Item #	Desc	UPC	Vendor	CS/UOS	Location
82280124	1.5 lb	732221117211	11721	12/12	National
82280125	3 lb	732221117228	11722	12/12	National

Tree And Shrub Food 19-8-10

Great for all types of trees and shrubs like shade trees, nut trees, evergreens, citrus, tropical and flowering trees. Feed trees and shrubs twice a year. Contains trace elements.

Item #	Desc	UPC	Vendor	CS/UOS	Location
82280071	4 lb Not For Sale HI, PR, VI, WI	732221108646	10864	12/12	National
82280072	20 lb Not For Sale HI	732221108653	10865	1/1	National

Azalea Camellia Rhododendron Food 9-15-13

Contains plant food with trace elements which create an acidic growing environment that's ideal for Azaleas, Camellias and Rhododendron to thrive and grow. **Not For Sale DE, HI, KY, MA, ME, MN, MT ND, NH, NM, PR, RI, VI, WI, WY**

Item #	Desc	UPC	Vendor	CS/UOS	Location
82280399	3.25 lb	732221136854	13685	12/12	National
82280045	15 lb	732221106956	10695	1/1	National

Premium Bedding Plant Food 7-22-8

A premium quality bedding plant food with micronutrients and slow release Nitrogen that assists in growing healthy bedding plants and perennials. **Not For Sale DE, HI, MD, ME, MT, NV, PR, RI, VI, WI, WY**

Item #	Desc	UPC	Vendor	CS/UOS	Location
82280056	4 lb	732221107618	10761	12/12	National

Rose Food 14-12-11

Rose Food provides the right nutrients to produce green leaves and new growth, which new blooms develop on Roses. Apply monthly during the growing season for bountiful blooms. **Not For Sale HI, KY, PR, VI, WI**

Item #	Desc	UPC	Vendor	CS/UOS	Location
82280066	4 lb	732221108301	10830	12/12	National

Blooming & Rooting Plant Food

A highly concentrated plant food that helps promote vigorous blooming, root development, larger blooms on flowering shrubs, trees, Roses, Orchids, Tomatoes and all blooming and fruit bearing plants. **Not For Sale AK, HI, PR, VI, WI**

Item #	Desc	UPC	Vendor	CS/UOS	Location
82280133	8 oz	732221117785	11778	24/24	National
82280130	1.5 lb	732221117716	11771	12/12	National
82280131	3 lb	732221117723	11772	12/12	National

Fruit Citrus & Pecan Tree Food 19-10-5

Great for all types of trees and shrubs like shade trees, nut trees, evergreens, citrus, tropical and flowering trees. Feed trees and shrubs twice a year. Contains trace elements. **Not For Sale DE, HI, MA, MD, ME, MT, ND, PR, VI, WI, WY**

Item #	Desc	UPC	Vendor	CS/UOS	Location
82280064	4 lb	732221108202	10820	12/12	West

2025

ferti-lome

Garden Cote 12-12-12

Specially formulated for flowers, vegetables and citrus blooms. NPK + Micros encourage greener flowering plants with more blooms. Can be used for annuals, perennials, petunias, pansies, impatiens, tomatoes, garden vegetables, peppers, melons and berries. It also can be added to soil around trees and shrubs, and applied to bulbs and bedding transplants. Time release fertilizer. **Not For Sale AK, CT, DE, HI, MD, ME, MS, MT, ND, NH, NJ, PR, RI, VI, VT, WI, WV, WY**



Item #	Desc	UPC	Vendor	CS/UOS	Location
82280140	1 lb	732221121409	12140	24/24	National
82280141	4.5 lb	732221121416	12141	12/12	National

Tomato & Vegetable Food 7-22-8

Provides essential nutrients for better growth, better flavor and bigger harvest by supplying plant food plus secondary nutrients to produce vigorous tomato and vegetable plants. **Not For Sale HI, PR, VI, WI, WV**



Item #	Desc	UPC	Vendor	CS/UOS	Location
82280068	4 lb	732221108554	10855	12/12	West
82280069	20 lb	732221108578	10857	1/1	West

Hibiscus & Tropical Plant Food 17-7-10

Fast acting Hibiscus and Tropical Plant Food. Enhances the size, color and quantity of blooms. Special formulation for Tropicals and Hibiscus that will stimulate long lasting, vibrant blossoms.



Item #	Desc	UPC	Vendor	CS/UOS	Location
82280102	4 lb Not For Sale AK, HI, OR, PR, VI, WA, WI	732221110458	11045	12/12	West
82280103	12 lb Not For Sale AK, HI, OR, WA	732221110472	11047	4/4	West



All Purpose Houseplant Food 10-10-10

Use to feed all potted plants, indoors and outdoors, including houseplants. 8oz liquid concentrate. **Not For Sale AK, HI, PR, VI, WI**

Item #	Desc	UPC	Vendor	CS/UOS	Location
82280181	8 oz	732221180017	18001	12/12	National

Succulent & Cactus Plant Food 2-7-7

Use to feed Cactus, Jade, Aloe and all succulents. 8oz liquid concentrate. **Not For Sale AK, HI, PR, VI, WI**

Item #	Desc	UPC	Vendor	CS/UOS	Location
82280182	8 oz	732221180116	18011	12/12	National

Orchid Plant Food 9-7-9

Use to feed all Orchids. 8oz liquid concentrate. **Not For Sale AK, HI, PR, VI, WI**

Item #	Desc	UPC	Vendor	CS/UOS	Location
82280183	8 oz	732221180215	18021	12/12	National

African Violet & Blooming Plant Food 8-10-8

Use to feed all African Violets and other flowering plants. 8oz liquid concentrate. **Not For Sale AK, HI, PR, VI, WI**

Item #	Desc	UPC	Vendor	CS/UOS	Location
82280184	8 oz	732221180314	18031	12/12	National

Insecticidal Soap

Use indoors, outdoors to control powdery mildew and listed insect pests such as adelgids (woolly aphids), aphids, lacebugs, mealybugs, mites, grasshoppers, leafhoppers, scale insects, plant bugs, sawfly larvae (pear and rose slugs), psyllids, tent caterpillars, thrips, spider mites, earwigs and whitefly.



Item #	Desc	UPC	Vendor	CS/UOS	Location
82280498	8 oz RTU	732221180611	18061	12/12	National

Fish Emulsion Fertilizer 5-1-1

Derived from concentrated fish solubles that supply the natural release of essential nutrients for the development of green foliage, vigorous root systems and solid plant structure. **Not For Sale HI, PR, VI, WI**



Item #	Desc	UPC	Vendor	CS/UOS	Location
82280029	16 oz	732221106116	10611	12/12	National
82280030	32 oz	732221106123	10612	12/12	National

2025



Root Stimulator & Plant Starter Solution 4-10-3

User both indoor or outdoor, for all of your new plantings. Stimulates early root formation, and stronger root development. 4-10-3 with indole-3-butyric acid. **Not For Sale AK, CA, HI, PR, VI, WI**



Item #	Desc	UPC	Vendor	CS/UOS	Location
82280038	16 oz	732221106406	10640	12/12	National
82280039	32 oz	732221106451	10645	12/12	National
82280040	1 gal	732221106505	10650	4/4	National

Chelated Liquid Iron & Other Micronutrients

A source of iron that is water soluble and readily available to plants. It can be used to prevent or correct chlorosis, the yellowing of leaves and other nutrient deficiencies in potted plants, shrubs, lawns, trees, flowers and vegetables. **Not For Sale HI, PR, VI, WA, WI**



Item #	Desc	UPC	Vendor	CS/UOS	Location
82280032	16 oz	732221106253	10625	12/12	National

Hi-Yield

Garden Fertilizer 8-10-8

Use on vegetables, flowers, trees, shrubs and tomatoes. Ideal tomato food and all varieties of vegetables. **Not For Sale DE, HI, ME, MT, PR, VI, WI**



Item #	Desc	UPC	Vendor	CS/UOS	Location
82280440	16 lb	732221340909	34090	1/1	West
82280231	20 lb	732221320901	32090	1/1	East

Tomato & Vegetable Food 4-10-6

Provides the proper nutrients necessary to promote vigorous growth, abundant vegetable harvest, and juicy tomatoes. **Not For Sale AK, CA, DE, HI, MD, ME, NH, PR, VI, VT, WI**

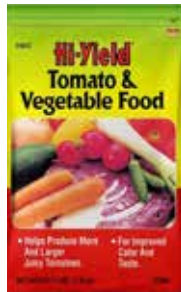

Item #	Desc	UPC	Vendor	CS/UOS	Location
82280232	4 lb	732221320949	32094	12/12	National

Fast Acting Gypsum

Fast-Acting Gypsum starts working immediately to help loosen compacted soil, including heavy clay soil and repairs salt damaged soil. **Not for sale in AK, DE, HI, MD, NJ, WI, PR, VI**



Item #	Desc	UPC	Vendor	CS/UOS	Location
82280225	4 lb	732221320543	32054	12/12	National

Bone Meal 0-10-0

Provides a slow release form of natural Phosphorus to help plant produce sturdy root systems, hastens maturity and stimulates plant growth. For use on bulbs, roses, flowers and shrubs. Excellent for vegetable gardens.



Item #	Desc	UPC	Vendor	CS/UOS	Location
82280240	4 lb Not For Sale HI, PR, VI, WA, WI	732221321243	32124	12/12	National
82280239	20 lb Not For Sale HI, WA	732221321205	32120	1/1	National

Bone & Blood Meal 6-7-0

The Bone & Blood Meal plant food provides an excellent combination of natural Nitrogen and Phosphate. This plant growth supplement is perfect for all flowers, ornamentals, shrubs and vegetables. The plant fertilizer is gentle on plants. Perfect for delicate roses and other flowers.



Not For Sale CA, HI, PR, VI, WA, WI

Item #	Desc	UPC	Vendor	CS/UOS	Location
82280241	3 lb	732221321267	32126	12/12	National

Calcium Nitrate

Calcium nitrate is ideal for use in vegetable gardens to prevent blossom end rot. It provides both calcium and nitrogen. Supporting cell formation, it neutralizes acids to detoxify the plants for a healthier growth! The nitrogen component is also responsible for fueling protein production and essentially leafy growth. The perfect purchase for a natural way to have a healthier garden with brighter, and better results.



Guaranteed to work like a charm every time! **Not For Sale AK, AZ, HI, OR, PR, RI, VI, WI**

Item #	Desc	UPC	Vendor	CS/UOS	Location
82280394	3.25 lb	732221321281	32128	12/12	National

Hi-Yield®



Magnesium Sulfate

Contains a soluble source of Magnesium that is readily available to aid in correcting plant chlorosis. Excellent for use on palms. Use to encourage white blooms on hydrangeas. **Not for sale HI, PR, VI, WA**

Item #	Desc	UPC	Vendor	CS/UOS	Location
82280465	3.25 lb	732221346345	34634	12/12	West
82280189	4 lb	732221216341	21634	12/12	East

Triple Super Phosphate 0-45-0

Concentrated form of super phosphate. Ideal for vigorous plant root growth, sturdy stems, and hastened maturity. Can be used on vegetables, shrubs, flowers, shade, and fruit trees. This concentrated source of readily available phosphorous promotes flower and fruit production and enhances vegetable yields. 2 pounds covers 100 square feet. Analysis: 0-45-0. 4-pound container.

Not for sale HI, CA, PR, VI, WI

Item #	Desc	UPC	Vendor	CS/UOS	Location
82280263	4 lb	732221322752	32275	12/12	National

Muriate Of Potash 0-0-60

An excellent source of Potassium, which aids plants in forming healthy stems, roots and tuber growth. Great for below ground forming vegetables such as potatoes, carrots and others. **Not for sale DE, HI, ME, PR, VI, WI**

Item #	Desc	UPC	Vendor	CS/UOS	Location
82280448	3.25 lb	732221321458	34145	12/12	National

Soil Sulfur

Designed to increase acidic conditions and to help lower pH in excessively alkaline soils. Great for use on lawns, acid loving ornamentals and vegetables. Allow for 6-8 weeks following application for results and effects to show. **Not for sale HI, PR, VI, WI**

Item #	Desc	UPC	Vendor	CS/UOS	Location
82280452	3.25 lb	732221341852	34185	12/12	National

Cottonseed Meal 6-1-1

A natural source of Nitrogen, Phosphate and Potash that helps create an acidic soil condition and aids in production of friendly soil bacteria. **Not for sale HI, PR, VI, WI**

Item #	Desc	UPC	Vendor	CS/UOS	Location
82280248	3 lb	732221321656	32165	12/12	National

Blood Meal 12-0-0

This plant growth supplement aids in plant productions of top growth and deep green foliage. Provides a slow release form of natural Nitrogen for continues feeding and reducing nitrogen burn. Can be used on pansies, roses, flowers, trees, shrubs and vegetables. **Not for sale HI, PR, VI, WA, WI**

Item #	Desc	UPC	Vendor	CS/UOS	Location
82280245	8 lb	732221321427	32142	4/4	National
82280246	2.75 lb	732221321441	32144	12/12	National

Aluminum Sulfate

Helps create an acid soil condition for plants. Intensifies Blue color in hydrangeas. Use on azaleas, gardenias, camellias, rhododendrons, blueberries and others listed on label. **Not for sale HI, PR, VI, WI**

Item #	Desc	UPC	Vendor	CS/UOS	Location
82280449	3.25 lb	732221341753	34175	12/12	West
82280253	4 lb	732221321755	32175	12/12	East

Growers Special 12-6-6

A time-release fertilizer that provides a complete feeding and contains Blue Chip form of Nitrogen. Can be used to feed all plants, even container grown, without burning. **Not for sale AK, CT, DE, HI, MD, MT, NH, NM, VT, WY, PR, VI, WI**

Item #	Desc	UPC	Vendor	CS/UOS	Location
82280289	4 lb	732221331907	33190	12/12	National

Super Phosphate 0-18-0

Provides a readily available form of phosphate which is used by plants during photosynthesis. This plant growth supplement promotes larger more beautiful blooms & fruit. This phosphate fertilizer can be used on outdoor plants for enhanced growth. **Not for sale HI, CA**

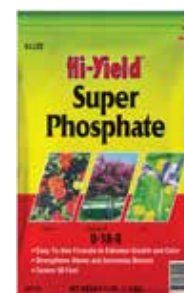

Item #	Desc	UPC	Vendor	CS/UOS	Location
82280444	3.25 lb	732221341159	34115	12/12	West
82280236	4 lb	732221321151	32115	12/12	East

Hi-Yield®



Dutch Bulb Food 7-8-5

Specifically designed to be used with all types of flowering bulbs at planting time in spring and fall. Provides necessary nutrients for proper root development and growth of bulbs. **Not For Sale DE, HI, MD, ME, PR, VI, WI**

Item #	Desc	UPC	Vendor	CS/UOS	Location
82280467	3.25 lb	732221347243	34724	12/12	National

Triple 16-16-16

Use when you only want to get one fertilizer for everything. Great for vegetables and flowers. Also use on trees, shrubs, evergreens, fruits, nuts and citrus. Can be used to help establish new lawns, when seeding. Use on 3,200 sq ft for seeding. Apply, work into the soil, then plant the grass seed. **Not For Sale AK, CT, DE, HI, IL, MD, ME, MN, ND, NH, PR, VA, VI, VT, WI, WV**

Item #	Desc	UPC	Vendor	CS/UOS	Location
82280273	20 lb	732221323513	32351	1/1	West

Agricultural Limestone

An easy method of correcting soil acidity, & replacing calcium in soils leached by rainfall. Improves soil condition & bacterial action.

Not For sale DE, HI, PR, RI, VI, WI

Item #	Desc	UPC	Vendor	CS/UOS	Location
82280244	6 lb	732221321366	32136	6/6	West

Iron Sulfate

The Iron Sulfate plant supplement is recommended for the prevention and correction of chlorosis. This plant fertilizer helps to give a beautiful green color to lawns, shrubs, flowers and gardens.

Not for sale in AK, HI, PR, VI, WI

Item #	Desc	UPC	Vendor	CS/UOS	Location
82280461	3.25 lb	732221343405	34340	12/12	National

Horticultural Hydrated Lime

Corrects soil acidity for shrubs, flowers, vegetables, lawns and house plants. Helps to loosen heavy clay soils and increases soil pH levels providing for better growth of plants. Can be used to keep down odor and flies around stables, outhouses, etc.

Not for sale in HI, PR, VI, WI

Item #	Desc	UPC	Vendor	CS/UOS	Location
82280472	4 lb	732221343719	34371	6/6	National



GROW MORE®

Cactus Juice 1-7-6

Grow More Cactus Juice is a high quality fertilizer for all cacti and succulents with soluble calcium to strengthen plant structure, reduce tissue softness and promote optimal growth.



Item #	Desc	UPC	Vendor	CS/UOS	Location
82570031	16 oz	080986031304	3130	12/12	West

Maxi-Cal 10-0-0

Maxi-cal liquid is a bio-effective formulation that prevents or corrects of physiological calcium and micronutrients deficiencies. Contains 10 percent calcium plus eight micros. Improves quality of fruits and vegetables.



Item #	Desc	UPC	Vendor	CS/UOS	Location
82570034	16 oz	080986130014	13001	12/12	West

Bonsai Nutrient Blend 1-1-1

Recommended for all container grown Bonsai, and native soil grown specimen plants. Our formula utilizes traditional slow acting organic nutrients, blood meal, bone meal, and barley meal. Low analysis formula designed to keep good color on foliage and eliminate loose spindly growth. Concentrated, makes 48 gallons. Derived from Blood, Bone, and Barley Meals.

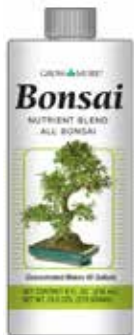

Item #	Desc	UPC	Vendor	CS/UOS	Location
82570036	8 oz	080986053719	5371	12/12	West

Lucky Bamboo 2-2-2

This fertilizer is great for the continued care of lucky bamboo providing the essential nutrients need to have healthy green growth For indoor and outdoor usage.



Item #	Desc	UPC	Vendor	CS/UOS	Location
82570033	8 oz	080986078576	7857	12/12	West



Stump Remover 13-0-44

Use as a fertilizer or stump remover. Helps maintain pink color of hydrangea grown in acidic soil.

Item #	Desc	UPC	Vendor	CS/UOS	Location
82570051	1 lb.	080986074219	7421	12/12	West

Soluble Palm Food 15-5-15

Recommended for all varieties of cycades and palms. A 3-1-3 ratio with extra Mn and Mg to correct frizzle top and yellow leaves in all palms. Developed by Dr. Timothy Borschat, professor at University of Florida to correct common palm tree deficiencies. Dissolve 1-2 tablespoons per gallon of water for soil drench. Apply during the growing season (warm summer months). Also contains chelated micronutrients water palms before applying fertilizer.

Item #	Desc	UPC	Vendor	CS/UOS	Location
82570003	1.5 lb.	080986051074	5107	12/12	West

Sea Grow All Purpose 16-16-16

Sea Grow All Purpose 16-16-16 is a hybrid blend of botanical seaweed extract, blood meal, organic carbon, amino acids, carbohydrates, primary N-P-K plant foods, yucca extract and micronutrients. Provides a bio-stimulant effect from seaweed promotes vigorous growth, better quality fruits and abundant blooms with better keeping and storage qualities. Recommended for indoor or outdoor growing situations, container plants or field grown plants using native soil and artificial mixes.

Item #	Desc	UPC	Vendor	CS/UOS	Location
82570016	1.5 lb.	080986060908	6090	12/12	West
82570018	3 lb.	080986081828	8182	12/12	West

Sea Grow Flower & Bloom 4-26-26

A hybrid blend of botanical seaweed extract, blood meal, organic carbon, amino acids, carbohydrates, primary N-P-K plant foods, yucca extract and micronutrients. Biostimulant effect from seaweed promotes vigorous growth, better quality fruits and abundant blooms with better keeping and storage qualities. Recommended for indoor or outdoor growing situation, container plants or field grown plants using native soil and artificial mixes.

Item #	Desc	UPC	Vendor	CS/UOS	Location
82570017	1.5 lb.	080986060618	6061	12/12	West
82570019	3 lb.	080986081842	8184	12/12	West

Tomato Food 18-18-21

This tomato food has special formula for all tomatoes with extra magnesium and higher potash ratio for firmer fruit and yields. No matter what type of tomatoes you love, from cherry to beefsteak, this food will produce the most flavorful, plump tomatoes every time. Potassium nitrate base instead of a potassium chloride base. Uses all EDTA micronutrients including copper and zinc, while others use sulfates.

Item #	Desc	UPC	Vendor	CS/UOS	Location
82570005	1.5 lb	080986052361	5236	12/12	West

Super Bloomer 15-30-15

Designed to promote abundant blooms and vibrant flowers, this water-soluble fertilizer provides a balanced mix of nitrogen, phosphorus, and potassium. The higher phosphorus content stimulates flower production, while the balanced nutrient ratio supports overall plant health and vigor. Simply mix the concentrate with water as directed and apply to your plants for impressive blooming results. With Grow More Super Bloomer, you'll enjoy a colorful and flourishing garden.

Item #	Desc	UPC	Vendor	CS/UOS	Location
82570013	1.5 lb.	080986074189	7418	12/12	West
82570014	3 lb.	080986074158	7415	6/6	West
82570015	5 lb. bag	080986074141	7414	6/6	West

Citrus Food 20-10-15

Properly timed foliar or soil application of this citrus food can help improve fruit color, firmness and earlier maturity. Helps trees respond with improved vigor, foliage color and helps reduce alternate year bearing tendencies. Chelated micronutrients. For use on all citrus including orange, lemon, grapefruit, tangerine, limes and tangelo. 20-10-15 Formulation.

Item #	Desc	UPC	Vendor	CS/UOS	Location
82570004	1.5 lb	080986086106	5260	12/12	West

Hydrangea Blueing Formula

Hydrangea bluing formula. Aluminum sulfate. Helps form acid soil for all hydrangea. Turns pink flowers blue. Pink and red forms often turn blue or purple in acid soils. Use for shrub, climbing vine, bug leaf garden and common varieties. Also used for azaleas, camellias, gardenias, fuchsias, begonias, rhododendrons.

Item #	Desc	UPC	Vendor	CS/UOS	Location
82570041	2 lb.	080986075391	7539	12/12	West

Hawaiian Bud & Bloom 5-50-17

Don't let your plants down! They'll grow, bloom and thrive better with this top-quality, balanced food. Easy-to-use, instant water-soluble concentrate. Economical too!



Item #	Desc	UPC	Vendor	CS/UOS	Location
82570009	1.5 lb	080986075056	7505	12/12	West
82570010	3 lb	080986075445	7544	12/12	West

Citrus Grower Blend 1.7-0-0

Citrus grower blend fertilizer with chelated micronutrients that provide a readily available source of chelated zinc manganese and copper.



Item #	Desc	UPC	Vendor	CS/UOS	Location
82570042	10 oz	080986080852	8085	12/12	West
82570043	20 oz	080986080869	8086	12/12	West

Soil Acidifier 30-10-10

Grow More Soil Acidifier 30-10-10 is an effective soil acidifier that will help acidify or lower the pH of the soil. It contains chelated micronutrients, soil penetrant, and trace elements that's ideal to use with acid-loving plants that grows in alkaline soil such as azaleas, gardenias, roses, hydrangeas, evergreens, camellias, rhododendrons, junipers, etc. It is used to correct the alkaline soil's problem and helps prevent yellow plant anemia.



Item #	Desc	UPC	Vendor	CS/UOS	Location
82570002	1.5 lb	080986074127	7419	12/12	West

Eco Pond Clear

Eco Pond Clear by Grow More, an all natural algae control for both slime and greenwater types of algae. All natural bacterial product, harmless to fish and plants may be used in new or established ponds.



Item #	Desc	UPC	Vendor	CS/UOS	Location
82570037	10 oz	080986151002	15102	12/12	West

All Seasons 20-20-20

Recommended for all varieties of cycades and palms. A 3-1-3 ratio with extra Mn and Mg to correct frizzle-top and yellow leaves in all palms. Developed by Dr. Timothy Borschat, professor at University of Florida to correct common palm tree deficiencies. Dissolve 1-2 tablespoons per gallon of water for soil drench. Apply during the growing season (warm summer months). Also contains chelated micronutrients water palms before applying fertilizer.



Item #	Desc	UPC	Vendor	CS/UOS	Location
82570001	1.5 lb.	080986075063	7506	12/12	West
82570008	5 lb.	080986052941	7431	6/6	West

Rapid Root #3

IBA root powder. EPA registered cloning powder. 1 ounce of Rapid Root powder will treat approximately 1500 cuttings. Our one dip treatment powder prevents cross contamination problem associated with liquid products. University tested system that parallels nature's own root forming hormone.



Item #	Desc	UPC	Vendor	CS/UOS	Location
82570047	2 oz	080986039980	3998	12/12	West

Siphon Mixer Injector

The easy-to-use Siphon Mixer is a great way to apply concentrated water-soluble fertilizers, fungicides, and insecticides through a garden hose. The Siphon Mixer connects directly to a hose bib and the powerful vacuum action siphons distillates at a 1:16 gallon ratio. No-clog unit features a back-flow check valve and is fit for permanent installation.



Item #	Desc	UPC	Vendor	CS/UOS	Location
82570052	5x1 pack	080986180057	18005	5/5	West

Magnum Rose Food 8-10-8

Magnum Rose Food is a complete one-step water-soluble fertilizer with chelated micronutrients and a soil penetrant. Manufactured to the highest quality available. Design is stylish and innovative. Satisfaction is ensured with this product. Formulated for all types of roses.



Item #	Desc	UPC	Vendor	CS/UOS	Location
82570011	1.5 lb	080986130151	13015	12/12	West
82570012	3 lb	080986030147	13014	12/12	West

Seaweed Extract

Grow more seaweed extract is liquefied organic kelp. Cold water processed to preserve minerals. Promotes plant growth and a vigorous root system. Foliar feed, root dip or soil drench.



Item #	Desc	UPC	Vendor	CS/UOS	Location
82570060	1 pt	080986060243	6024	12/12	West
82570061	1 qt	080986060489	6048	12/12	West
82570062	1 gal	080986060410	6041	4/4	West

Wet Soil Penetrant

EZ wet soil penetrant. Can be used on any soil. Promotes a deeper root system. Helps move excess salt away from the root zone. Nonionic and has a neutral ph. Helps alleviate dry spots and soil compaction problems. Regular use will promote a deeper root system. Leach excess salts away from the root zone, alleviate nun-off, erosion.



Item #	Desc	UPC	Vendor	CS/UOS	Location
82570049	1 qt	080986080555	8055	12/12	West
82570050	1 gal	080986080166	8016	4/4	West

Grow Vite 16-4-2

Grow More Grow-vite is an all purpose fertilizer with chelated iron, zinc, manganese and a special soil penetrant to help ensure these essential nutrients will be readily available to the roots and plant foliage. Ideal for lawns, flowers and vegetables.



Item #	Desc	UPC	Vendor	CS/UOS	Location
82570032	1 gal	080986076602	7549	4/4	West

Jump Start

Grow More Jump Start contains a unique combination of amino acids, micronutrient, vitamins & growth factors in the formula which help your plants thrive while accelerating leaf, stem & root growth.



Item #	Desc	UPC	Vendor	CS/UOS	Location
82570054	1 qt	080986074363	7436	12/12	West
82570055	1 gal	080986074379	7437	4/4	West

Better Than Fish 5-1-1

All natural based fertilizer that provides a great source of water soluble amino acids. The fertilizer features deodorized compositions and it is formulated with naturally occurring Nitrogen-Phosphate-Potassium ratio of five-one-one. Additionally, this fertilizer contains seaweed extracts that will help you achieve a successful plant growth and vigorous root system.



Item #	Desc	UPC	Vendor	CS/UOS	Location
82570065	1 gal	080986069819	6981	4/4	West

Indoor & Outdoor Food 20-6-16

Grow More Indoor & Outdoor Plant Food 20-6-16 is a specially formulated plant food that will provide complete nutrients to your plants. It has a combination of Urea-free formula which includes calcium, sulfur, magnesium, and other essential micronutrients. This Indoor/Outdoor plant food comes in a 1.25-pound jar and has a high nitrogen ratio to help boost stem and leaf growth.



Item #	Desc	UPC	Vendor	CS/UOS	Location
82570022	1.25 oz	080986075094	18010	12/12	West

Bromeliad Tillandsia Food 17-8-22

Bromeliad Tillandsia food is a premium quality to use indoor or outdoor for showy flowers in branched leaf clusters and handsomely marked flower clusters; 17-8-22



Item #	Desc	UPC	Vendor	CS/UOS	Location
82570030	10 oz	080986138102	13810	12/12	West
82570021	1.25 lb	080986051180	5118	12/12	West

Orchid Urea Free Growth Food 20-10-20

This premium orchid fertilizer is urea free, good nitrogen availability under wide range of temperature and climate conditions. Water soluble feedings, regularly result in many blooms, healthy, long lived orchids. 20-10-20 formulation. Available in 1.25-pound jar.



Item #	Desc	UPC	Vendor	CS/UOS	Location
82570027	10 oz	080986105272	5271	12/12	West
82570023	1.25 lb	080986052705	5270	12/12	West

Orchid Food 30-10-10

Grow More Orchid Growth 30-10-10 is great for all orchids during the growing season. It feeds through leaves and roots stimulating bud formation and root development. No harmful chlorides or sodium.



Item #	Desc	UPC	Vendor	CS/UOS	Location
82570029	10 oz	080986138133	13813	12/12	West
82570025	15 oz	080986053603	5360	12/12	West

Orchid Food Fertilizer 20-20-20

Use Grow More 20-20-20 as a general purpose, all-year-round feed for all sorts of orchids: such as Cattleyas, Vandas and Dendrobiums and other orchids. Recommended for slab-mounted epiphytic orchids, those with exposed root systems, as well as terrestrial orchids in soil-based potting mixtures.



Item #	Desc	UPC	Vendor	CS/UOS	Location
82570028	10 oz	080986053993	5399	12/12	West
82570024	1.25 lb	080986051210	5121	12/12	West

Orchid Bloom Formula Fertilizer 6-30-30

Grow More Orchid Bloom is specially designed plant food with a high phosphate to nitrogen ratio that helps improve bud set and increases the size and color of blooms. No harmful chlorides or sodium.



Item #	Desc	UPC	Vendor	CS/UOS	Location
82570026	10 oz	080986038143	13814	12/12	West
82570020	1.25 lb	080986051203	5120	12/12	West



All-Purpose 10-10-10

General purpose fertilizer. Provides sustained feeding with a balanced nutrient supply. Excellent for use on trees, shrubs, vegetables, flowers, and ornamental gardens. Ideal for use with newly seeded lawns.

Not For Sale in CA, OR, PR, WA, NB



Item #	Desc	UPC	Vendor	CS/UOS	Location
80350053	40 lb.	88685301926	21-30192	40/1	East

Garden Food 5-10-5

A general purpose granular fertilizer. Recommended for flowers, shrubs, and ornamentals. Helps produce strong vigorous root systems and sturdy plants. Non-acid forming formulation. **Not For Sale in AR, AZ, CA, CO, FL, IA, MS, MT, NM, NV, OK, OR, PR, TX, WA, WY, NB**



Item #	Desc	UPC	Vendor	CS/UOS	Location
80350062	40 lb.	88685400421	21-40042	40/1	East



Worm Castings Soil Conditioner

Harris Worm Castings are the microbial-rich waste by-product that earthworms produce after eating nutrient-rich organic matter (e.g., leaves, plants, fruit). Often considered the "superfood of gardening", worm castings contain organic material beneficial for all your gardening needs. In addition, worm castings improve soil structure, water retention and drainage.



Item #	Desc	UPC	Vendor	CS/UOS	Location
82770102	4 qt.	072725012521	WORM-4	5/5	National

Horticultural Charcoal

Increases soil carbon, nutrient content, water retention, water-soluble nutrients, and beneficial microbial life. Made from plant materials such as hardwoods, grasses, and agricultural and forest residues. Use in gardens, ornamentals, terrariums, or small houseplants such as orchid or bonsai.



Item #	Desc	UPC	Vendor	CS/UOS	Location
82770106	2 qt.	072725014136	CHAR-2	4/4	National



Tomato Food 5-10-10

Satisfies heavy feeding requirements of tomatoes. Helps establish new plants quickly and can be used on all garden vegetables.



Item #	Desc	UPC	Vendor	CS/UOS	Location
80070084	4 lb.	071605270044	27004	10/10	East

Bone Meal 4-12-0

All Natural Organic Bone Meal promotes superior plant growth and beautiful blooms. Slow release nitrogen feeding for all bulbs, flowering shrubs and perennials.



Item #	Desc	UPC	Vendor	CS/UOS	Location
80070053	3 1/2 lb.	071605202038	20203	12/12	East

Dried Blood 12-0-0

An all natural organic supplemental high-nitrogen plant food. Greens up yellowing leaves and promotes foliage growth. Long-lasting, even feeding of nitrogen. Excellent for all leafy plants and vegetables, especially lettuce, cabbage and swiss chard.

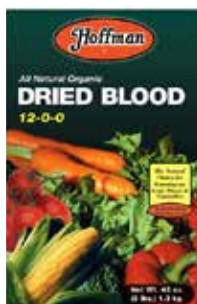

Item #	Desc	UPC	Vendor	CS/UOS	Location
80070055	3 lb.	071605216035	21603	10/10	East

Purely Organic Plant Food 4-2-3

All purpose garden & flower food, certified organic poultry manure based. No chemicals or contaminants, safe to use around people and animals. Produces outstanding results in flower and vegetable gardens and lawns.



Item #	Desc	UPC	Vendor	CS/UOS	Location
80070066	4 lb.	071605200041	20004	12/12	East
80070067	10 lb.	071605200102	20010	5/5	East

Muriate of Potash 0-0-60

Enriched source of potassium for plants. Imparts increased plant vigor and helps stiffen stems.



Item #	Desc	UPC	Vendor	CS/UOS	Location
80070078	5 lb.	071605645057	64505	10/10	East



Coop Poop™

Aerobically Composted Chicken Manure: An all-natural, slow-release, non-burning organic blend rich in humates, carbohydrates and trace minerals, which naturally enhances any soil type and promotes plant quality. **Not For Sale UT**



Item #	Desc	UPC	Vendor	CS/UOS	Location
81350052	1 lb.	855161009597	HGR 243 CP 1	6/6	East
81350006	6 lb.	855161002048	HGR 243 CP 6	6/6	East
81350004	25 lb.	855161002024	HGR 243 CP 25	78/1	East
81350005	40 lb.	855161002031	HGR 243 CP 40	50/1	East

Worm Castings

Increases beneficial microbial activity and enhances the soil. Provides faster growth, larger plants, and bigger yields.



Item #	Desc	UPC	Vendor	CS/UOS	Location
81350022	15 lb.	855161002512	HGR WC15	1/1	East

Corn Gluten

Corn gluten that provides lush green turf throughout the growing season. Greens lawn with no synthetic chemicals. Grows deeper roots and improves water retention and aids in the prevention of some common weeds, like dandelions and crabgrass.



Item #	Desc	UPC	Vendor	CS/UOS	Location
81350003	30 lb.	793573053411	HGR 900 CG30	1/1	East



ClassiCote™ with Crystal Green® 15-8-23

A time release fertilizer perfect for both indoor and outdoor planting. Jack's Crystal Green formula provides plants with a quick green up, while the time release fertilizer feeds for up to four months.



Item #	Desc	UPC	Vendor	CS/UOS	Location
80060054	2 lb	671341540328	54032	12/12	National
80060055	4 lb	671341540045	54004	6/6	National
80060065	6 lb	671341540960	54096	4/4	National
80060041	25 lb bag	671341540250	54025	1/1	National
80060034	200 sample packets	671341700014	54000	1/1	National

All Purpose 20-20-20

More professional growers have used this product for all their growing needs than any other formula. It is a balanced blend of Nitrogen, Phosphorus and Potassium with fully chelated trace elements that works on all plant materials as a general-purpose fertilizer. Indoors it is especially effective on foliage plants to keep leaves green and happy.



Item #	Desc	UPC	Vendor	CS/UOS	Location
80060003	8 oz.	671341520085	52008	12/12	National
80060002	1 1/2 lb.	671341520245	52024	12/12	National
80060011	4 lb.	671341520641	52064	6/6	National
80060018	10 lb.	671341520108	52010	1/1	National
80060033	350 sample packets	671341999997	52000	1/1	National

Orchid Bloom Booster Liquid 3-9-6

This product is easy to mix and use. Orchid Bloom Booster contains not only major and minor elements but also calcium and magnesium, which is essential when using rain water, reverse osmosis water and relatively pure waters for growing. When used in conjunction with the Jack's Classic Orchid 7-5-6, it is the perfect system to keep your orchids producing excellent leaves and blooms throughout the year.



Item #	Desc	UPC	Vendor	CS/UOS	Location
80060008	8 oz.	671341503088	50308	12/12	National

Orchid Special 30-10-10

High Nitrogen balance for orchids grown in fir bark. Feeds through both the roots and the leaves to ensure the development of new leaves. Designed to prevent nitrogen drawdown from the decomposition of the orchid fir bark growing material.



Item #	Desc	UPC	Vendor	CS/UOS	Location
80060010	8 oz.	671341530084	53008	12/12	National

Orchid Liquid 7-5-6

Easy to mix and use and contains not only major and minor elements but also Calcium and Magnesium, which is essential when using rain water, reverse osmosis water, and relatively pure waters for growing. When used in conjunction with the Jack's Classic Orchid Bloom Booster 3-9-6, it is the perfect system to keep your orchids producing excellent leaves and blooms throughout the year.



Item #	Desc	UPC	Vendor	CS/UOS	Location
80060009	8 oz.	671341507086	50708	12/12	National

Houseplant Special 15-30-15

Designed for use on all foliage and flowering plants. This formula has had much success over 60 years since its original design - the classic nutrient blend produces long-term green lush growth.



Item #	Desc	UPC	Vendor	CS/UOS	Location
80060007	8 oz.	671341515081	51508	12/12	National

African Violet 12-36-14

This 12-36-14 plant food has been a favorite of commercial African Violet growers for over 30 years. Perfect to maximize flower count, size and bright color on standard African Violet varieties.



Item #	Desc	UPC	Vendor	CS/UOS	Location
80060001	8 oz.	671341512080	51208	12/12	National



Hydrangea Blue 7-3-3

Unlike other blue enhancers, we have kept the standards you have come to trust in the Peters family name. We have designed this unique formula to not just keep your hydrangeas blue BUT to provide them with the nutrients they need for strong growth and well-being.

2025

Item #	Desc	UPC	Vendor	CS/UOS	Location
80060030	1.5 lb.	671341593249	59324	12/12	National

Tropical Food 16-5-25

Tropical Food 16-5-25 is a blend of essential nutrients designed for the unique requirements of Tropical Plants. It is formulated to prevent the build up of harmful salts while delivering additional potassium, magnesium, sulfur and micronutrients. Jack's Classic Tropical Food produces lush green leaves and strong growth in both pots and landscapes.

Item #	Desc	UPC	Vendor	CS/UOS	Location
80060016	1.5 lb.	671341516248	51624	12/12	National

Blossom Booster 10-30-20

Professional formula for more flowers and brighter colors on all outdoor and indoor plants. Includes minor nutrients, too. Plastic Tub with 100% Waterproof labeling.

Item #	Desc	UPC	Vendor	CS/UOS	Location
80060006	8 oz.	671341510086	51008	12/12	National
80060005	1½ lb.	671341510246	51024	12/12	National
80060004	4 lb.	671341510642	51064	6/6	National
80060014	10 lb.	671341510109	51010	1/1	National
80060036	Sample Pack 350 count box	671341700036	51000	1/1	National

Acid Special 17-6-6

Very effective in reducing the soil pH, which keeps iron and other trace elements available to the plant. In plantings next to the concrete foundations of the home, where the pH is elevated, it will keep the leaves green and healthy, promoting lush vegetative growth and better blooms. This formula contains elevated levels of iron and sulfur which most of the acid loving plants require.

Item #	Desc	UPC	Vendor	CS/UOS	Location
80060017	1.5 lb.	671341517245	51724	12/12	National
80060043	4 lb.	671341517641	51764	6/6	National

Veggie FeED 12-15-30

Veggie FeED 12-15-30 is formulated for vigorous plant growth from roots to green foliage, abundant flowering and fruit set for all garden vegetables. Veggie FeED contains a micronutrient package and Magnesium for improved feeding results under diverse soil and growing conditions. It also includes Calcium, an effective nutrient to help prevent blossom end rot.

Item #	Desc	UPC	Vendor	CS/UOS	Location
80060042	1½ lb.	671341513247	51324	12/12	National
80060066	4 lb.	671341513643	51364	6/6	National

Citrus FeED 20-10-20

Citrus FeED 20-10-20 is designed to provide the optimum combination of nutrients needed by plants in the citrus group. This formula with enhanced micronutrient levels will produce vibrant green leaves, strong branches and more fruit.

Item #	Desc	UPC	Vendor	CS/UOS	Location
80060019	1.5 lb.	671341525240	52524	12/12	National

Petunia FeED 20-6-22

Specially formulated for iron hungry crops such as petunia, calibrachoa, bacopa, nemesia, diascia, scaevola and others! Feeds through both the roots and the leaves.

Item #	Desc	UPC	Vendor	CS/UOS	Location
80060021	1½ lb.	671341526247	52624	12/12	National
80060038	4 lb.	671341526643	52664	6/6	National
80060020	10 lb.	671341526100	52610	1/1	National
80060037	350 sample pkts	671341700043	52600	1/1	National





Pro-Tekt® 0-0-3 Silicon Supplement

Dyna-Gro Pro-Tekt is a nutritional supplement for plants that's in an easy-to-use liquid concentrate that's ideal for hydroponic use. The Pro-Tekt Silicon Solution adds mechanical strength to stems, helps improve heat tolerance, and helps improve drought tolerance.

Dyna-Gro Pro-Tekt is recommended for all plants. It contains potassium and 2% Soluble Silicon to reduce stress caused by heat, cold & drought. It's safe for plants and effective for use in soil & soilless media. For best results, use in conjunction with the Dyna-Gro nutrient family of products.



Item #	Desc	UPC	Vendor	CS/UOS	Location
81875041	1 qt.	080359090327	DTEK-032	12/12	West
81875042	1 gal	080359091003	DTEK-100	4/4	West
81875043	5 gal	080359095001	DTEK-500	1/1	West



Tree, Shrub, & Evergreen Spike

Organics slow release evergreen fertilizer spikes are specially formulated to help most plants increase root mass, support healthy foliage growth and to develop stronger and healthier plants overall. It provides reliable, long-term benefits to your garden without relying on synthetic chemicals, creating a healthy ecosystem for your plants, family, and the environment.



Item #	Desc	UPC	Vendor	CS/UOS	Location
80180348	Organic Tree & Shrub 8pk	073035012102	1210	12/12	National
80180133	Tree 9pk	073035013109	1310	12/12	National

Evergreen Fertilizer Spikes

Fertilizer stakes specially formulated for evergreen trees that ensure a continuous supply of nutrients below the surface. Easy to insert around a tree's drip-line. Last all season long. No runoff, no mess, and odor free. Stakes feed tree roots for up to 60 days.



Item #	Desc	UPC	Vendor	CS/UOS	Location
80180136	Evergreen 9pk	073035013116	1311	12/12	National

Tomato Fertilizer Spikes 6-18-6

For beautiful, healthy, juicy and big tomatoes. Special formula does the job from the roots up. Feeds for 8 weeks.



Item #	Desc	UPC	Vendor	CS/UOS	Location
80180026	18pack w/ clipstrip	073035060059	6005	24/24	National
80180147	Shelf Blister 18pack	073035060486	6000	12/12	National

Rose Fertilizer Spikes 9-12-9

Give your rose bushes the extra nourishment they crave with Jobe's Fertilizer Spikes for Roses. Unlike surface fertilizers that can wash away with rain or watering, Jobe's works underground at the plants roots, providing heightened growing power and healthy blooms that create a focal point for your home landscape.



Item #	Desc	UPC	Vendor	CS/UOS	Location
80180025	10 Pack	073035040020	4102	12/12	National

Tree Spikes

Easy to insert around the tree's dripline, the slow-release formula lasts all season. The pre-measured spikes make fertilizing easy with no measuring, hazardous chemicals or smells. Bag of 5.



Item #	Desc	UPC	Vendor	CS/UOS	Location
80180140	Tree	073035020107	2010	32/32	National
80180141	Evergreen	073035020114	2011	32/32	National
80180142	Fruit Tree	073035020121	2012	32/32	National

Bulk Fertilizer Tree Stakes

Jobe's® Fertilizer Spikes ensure a continuous supply of nutrients below the surface, where the trees' active roots are growing. Jobe's Spikes are easy to insert around each tree's dripline, and the slow-release formula lasts all season. No wasteful runoff, no mess, hazards or smells – only a safe beautiful yard. 160 bulk stakes per case

Item #	Desc	UPC	Vendor	CS/UOS	Location
80180376	Tree & Shrub	073035026109	2610	160/160	National
80180377	Evergreen	073035026116	2611	160/160	National
80180378	Fruit & Citrus	073035026123	2612	160/160	National



Start 0-2-0

Liquinox Start Vitamin B1 (0-2-0) transplant solution is a growth-promoting substance that includes vitamin b-1, yucca extract base, chelated iron and phosphoric acid. Start is specifically formulated to help reduce transplant shock and to stimulate feeder root growth. In addition, start is an effective transplant solution for use on all types of transplants. Light and frequent applications of start will result in good, healthy root structure and a successful planting.



Item #	Desc	UPC	Vendor	CS/UOS	Location
82610006	1 qt	011578020321	2032	12/12	West
82610007	1 gal	011578021281	2128	4/4	West

Bloom 0-10-0

Liquinox Bloom is a non-nitrogen formula created especially for flowers, fruits and vegetables. Excellent for plants that require greater acid concentration and as a winter food. Contains a wetting agent (yucca extract base) that helps loosen soils and aids in water penetration. Good on all flowers during budding and blooming periods. Helps toughen plants to withstand extreme climates.



Item #	Desc	UPC	Vendor	CS/UOS	Location
82610004	1 qt	011578010322	1032	12/12	West
82610005	1 gal	011578011282	1028	4/4	West

Fish Fertilizer 5-1-1

Liquinox Fish (5-1-1) is a fertilizer that may be used as a soil drench (applied directly to the soil) or foliar fed (applied directly to the leaves.) This product is safe and non-burning for use on vegetables, flowers, shrubs, lawns, and trees. May be used in garden all year long.



Item #	Desc	UPC	Vendor	CS/UOS	Location
82610012	1 qt	011578070326	7032	12/12	West
82610013	1 gal	011578071286	7128	4/4	West

Western State

Liquinox Western States Vitamin B1 is for root growth and transplants. Active Ingredients: Iron, manganese. Zinc manufactured in United States.



Item #	Desc	UPC	Vendor	CS/UOS	Location
82610010	1 qt	011578060327	6032	12/12	West
82610011	1 gal	011578061287	6128	4/4	West

Iron & Zinc Fertilizer

Liquinox Iron + Zinc (0.1FE 0.1ZN) is an essential blend of fully chelated iron and zinc, which is designed for correction of chlorosis (yellowing leaves). This fully chelated solution does not contain sulfates and is an excellent product for achieving a dark green look.



Item #	Desc	UPC	Vendor	CS/UOS	Location
82610008	1 qt	011578030320	3032	12/12	West
82610009	1 gal	011578031280	3128	4/4	West

Citrus & Avocado Food 6-9-6

Use Liquinox Citrus & Avocado Food 6-9-6 as an excellent acid plant food designed to aid producing good, healthy solid fruit. Liquinox Citrus & Avocado Food 6-9-6 has been especially formulated for the avocado and citrus industry. This product has been tried and proven since 1944 and, will result in good firm fruit.



Item #	Desc	UPC	Vendor	CS/UOS	Location
82610014	1 qt	011578050328	5032	12/12	West

Grow + 8-0-0

Grow Plus is a calcium based fertilizer great for all plants in your yard and landscape. Calcium plays a important function in plant uptake. Builds strong cell walls and increases plant vitality calcium plays a critical role in soil balance and soil salinity and IMPROVES WATER PENETRATION. Every plant need calcium to grow and will help reduce plant stress. apply every two weeks all year long for beautiful landscape



Item #	Desc	UPC	Vendor	CS/UOS	Location
82610015	1 gal	011578101297	10129	4/4	West



Grow 10-10-5

Liquinox Grow (10-10-5) is a concentrated all purpose fertilizer specifically formulated for use on all types of indoor and outdoor plants. Grow encourages all year round growth. It is an excellent plant food for anything that you want to grow! The Nitrogen increases foliage color, stem growth and helps plants keep their vibrant colors. Phosphates encourage root growth, hasten maturity and increase plant hardiness.



Item #	Desc	UPC	Vendor	CS/UOS	Location
82610002	1 qt	011578101327	132	12/12	West
82610003	1 gal	011578101280	128	4/4	West



Moisture Tester

Instantly tells you when to water plants, prevents over watering, ideal for plants grown in window boxes, hanging baskets & growbags.

Item #	Desc	UPC	Vendor	CS/UOS	Location
80140049	1 Meter	03530718106	1810	12/12	National

4-IN-1 Tester

Helps to provide a healthy growing environment by indicating levels of sunlight, fertility, soil moisture, and soil alkalinity/acidity. No batteries are required.

Item #	Desc	UPC	Vendor	CS/UOS	Location
80140052	1 Meter	3530718182	1818-6	6/6	National

Soil pH Tester

Tests the acidity of soil quickly and easily with this soil pH tester. Gauge instantly displays from acid to alkaline the soils pH for quick results. Check which plants suit your soil with a reference guide for over 50 plants. Enables you to alter soil conditions. Use for fruits, flowers, shrubs and vegetables. No batteries required for operation.

Item #	Desc	UPC	Vendor	CS/UOS	Location
80140050	1 Meter	03530718151	1815	12/12	National

Rapitest® Digital pH Meter

The slender redesigned meter style provides an easier to read, instant digital read-out. It measures and displays the acidity / alkalinity of garden and container soil. Batteries are required and included. Use for vegetables, flowers, fruits or landscaping plants of all kinds.

Item #	Desc	UPC	Vendor	CS/UOS	Location
80140010	1 Meter	035307018458	1845	12/12	National

Rapitest® Digital Moisture Meter

This sleek updated design offers an instant and easy to read digital format. It checks soil moisture where it counts: at root level. Monitoring a plant's soil moisture level helps prevent over and / or under watering. Batteries required and included. Use for vegetables, flowers, fruits or landscaping plants of all kinds.

Item #	Desc	UPC	Vendor	CS/UOS	Location
80140008	1 Meter	035307018250	1825	12/12	National



Dial Compost Thermometer

Rapitest soil thermometers are a must have tool for determining soil temperature when planting in early season or transplanting. Classic, Dial and Digital varieties are available along with a compost thermometer for use when composting.



Item #	Desc	UPC	Vendor	CS/UOS	Location
80140038	6.5"	035307016300	1630	6/6	National
80140039	19"	035307016355	1635	6/6	National

Rain Gauge with Bracket

Rapitest Rain Gauges are made to accurately record rain fall while decoratively accenting the yard, patio or garden. Whether they come with a decorative bracket or adjustable stake, all components are included for easy assembly and placement. All of our cylinders are polystyrene to resist the effects of weather and resist breaking if dropped.



Item #	Desc	UPC	Vendor	CS/UOS	Location
80140062	5"	035307016386	1638	6/6	National



Rapitest® Soil pH Meter

Checks which plants suit your soil pH and tells you how to alter soil. A pH performance guide for more than 350 plants is included. Ideal for potted indoor and outdoor plants. Simple readout. No batteries required.



Item #	Desc	UPC	Vendor	CS/UOS	Location
80140009	1 Meter	035307018403	1840	6/6	National

Rapitest® Moisture Meter

Determines the moisture level where it matters - at the roots. New meter style with probe on flexible cord. Instantly tells you when to water your plants. Helps prevent over or under watering. Instruction booklet gives individual needs for over 150 plants. No batteries required.



Item #	Desc	UPC	Vendor	CS/UOS	Location
80140007	1 Meter	035307018205	1820	6/6	National

Rapitest® Moisture & Light Meter

Combination meter checks both sunlight and moisture. Instantly measure soil moisture levels and sunlight exposure with this meter. Gauge displays on a scale of 1-10 (dry-wet) and A-H (cloudy-sunny), and tethered stainless steel probe will measure water at the root level. Includes watering needs for over 150 plants. No batteries required for operation.



Item #	Desc	UPC	Vendor	CS/UOS	Location
80140046	1 Meter	035307018304	1830	6/6	East

Rapitest® SunCalc Sunlight Calculator

The SunCalc provides gardeners with the ability to maximize plants growing potential by placing them in optimum light conditions. It measures the amount of accumulated light that falls on a specific location. This provides gardeners with the ability to match a plant's nursery tag light requirements (full sun, partial sun, etc.) with the actual light conditions as measured by SunCalc.



Item #	Desc	UPC	Vendor	CS/UOS	Location
80140043	Sunlight Calculator	035307018755	1875	6/6	East

Rapitest® Electronic Soil Tester

Determines soil pH and fertility level. Both tests can be completed in about a minute. Requires one AA battery. Complete instructions include how to adjust pH and select appropriate fertilizers according to soil conditions.



Item #	Desc	UPC	Vendor	CS/UOS	Location
80140011	1 Meter	035307018601	1860	6/6	National

Rapitest® 4-Way Analyzer

Measure four soil moisture indicators at once with this Luster Leaf Rapitest 4-way soil moisture meter. Prevent scorching, overwatering and over fertilizing and ensure the soil moisture/acidity/alkalinity is ideal for whatever you are about to plant. The electronic soil analyzer checks combined soil N-P-K level based on USDA standards and you can toggle between various gauges for instant readings.



Item #	Desc	UPC	Vendor	CS/UOS	Location
80140044	1 Meter	03530718809	1880	3/3	National





Rapiclip Garden Measuring Cup

Calibrated in tablespoons, ounces, cups, mill., and cubic centimeters. In PDQ shelf display with full color label.

Item #	Desc	UPC	Vendor	CS/UOS	Location
80140186	Measuring Cup	035307908070	807	24/24	National

Rapitest® Soil Test Kit

Takes the guess work out of determining whether your soil pH needs adjusting or if nitrogen, phosphorus and potash should be added in the form of fertilizers. Just mix soil and water together, pour off solution into comparator, add one tablet, shake and compare to color chart. It's just that easy. Contains supplies for pH, nitrogen, phosphorus and potash.



Item #	Desc	UPC	Vendor	CS/UOS	Location
80140001	40 Tests	035307016010	1601	6/6	National
80140213	200 Tests	097395216659	1665	1/1	East

Rapitest® pH Soil Tester

The ideal test to determine soil acidity/alkalinity. Particularly valuable for adjusting soil conditions for better growing lawns and plants. Just mix soil and water, pour off solution into comparator, add tablet, shake and compare to color chart. Ten pH tests each.



Item #	Desc	UPC	Vendor	CS/UOS	Location
80140004	10 Tests	035307016126	1612	12/12	National



Foli-Cal

Foli-Cal: Liquid calcium formulation based on 10% calcium acetate. Corrects calcium deficiency disorders such as blossom end-rot on tomatoes, peppers, eggplant and bitter pit in apples. Works on vegetables, trees and vine crops. **Not For Sale MA, ME, ND, RI, VY, WA, WI, WY**



Item #	Desc	UPC	Vendor	CS/UOS	Location
80820147	RTU 32 oz	022179103993	LG 7198	12/12	National

Sequestar® Iron 6%

Sequestar Iron 6% 3-0-0 is a water-soluble granular form of iron that corrects iron deficiency in plants. It contains Eddha, a top-of-the-line agent in chelating materials. This is highly effective in alkaline soils but can also work in more acidic soil conditions. Soil drenching is the best way of applying this product. The formula is readily available to the plant and can quickly cure chlorosis of even deep-rooted plants. The plants can be treated every 3-4 months at a lower rate.



Not For Sale AR, DE, FL, KY, MA, ME, ND, NH, RI, SC, VT, WV,

Item #	Desc	UPC	Vendor	CS/UOS	Location
80820151	4 oz	022179100770	LG 7150	12/12	West



All Purpose Plant Food 10-4-3

Easy, economical, effective, perfect choice for the time-challenged home gardener looking for a more sustainable plant food. One formulation for everything your customers grow: flowers, trees, shrubs, vegetables and herbs. Concentrated formula is easy to mix and goes a long way - offering a great value. Liquid concentrate containing oilseed extract which is a renewable source of plant nutrition and feeds the soil too. Pathogen free - heavy metals free - GMO free.

Item #	Desc	UPC	Vendor	CS/UOS	Location
80610001	15 oz	615369375401	7540-US	12/12	East
80610002	32 oz	615369375302	7530-US	12/12	East
80610004	64 oz	615369375203	7520-US	6/6	East



Fish-Seaweed Blend 2-3-1

A perfect blend of fish hydrolysate and seaweed. Fish and seaweed are known to build the natural sugar in plants. Flowers and foliage will be stronger and more colorful. Blooms will be more plentiful, fragrant and longer lasting. Great for all plants, indoor and outdoor. Best all-purpose, and #1 seller.



Item #	Desc	UPC	Vendor	CS/UOS	Location
80120011	18 oz.	081435218123	FS118	12/12	National
80120012	36 oz.	081435236127	FS136	12/12	National
80120013	1 gal.	081435240094	FS191	4/4	National
80120014	5 gal.	081435250451	FS150	1/1	National

Hydrolyzed Fish 2-4-1

Organic, highly nutritional protein fertilizer made with naturally occurring enzymes present in fresh north Atlantic fish. Nitrogen, derived from fish protein in the form of amino acids, slowly breaks down into basic compounds when added to soil. Does no biological damage to the soil and will promote the growth of beneficial bacteria. Because no oils or proteins are removed, the nutrients remain in the soil longer.



Item #	Desc	UPC	Vendor	CS/UOS	Location
80120001	18 oz.	081435018129	HF 118	12/12	National
80120002	36 oz.	081435036123	HF 136	12/12	National
80120003	1 gal.	081435040090	HF 191	4/4	National

Seaweed Plant Food 0-0-1

Growth promoting substances (Auxins, Cytokinins, Gibberellins) enhance plant development, color and vigor. Seaweed has also been found to increase plant hardiness and resistance to adverse environmental conditions, such as early frost, extreme heat and lack of moisture. Used as a seed inoculant, seaweed fertilizer increases and accelerates germination, and enhances the rapid development of a healthy root system. Seaweed is an excellent addition to any fertilization program.



Item #	Desc	UPC	Vendor	CS/UOS	Location
80120004	16 oz.	081435118126	SW 118	12/12	National
80120008	32 oz.	081435136120	SW 136	12/12	National
80120009	1 gal.	081435140097	SW 191	4/4	National

Tomato & Veg 2-4-2

This is a perfect complete fertilizer for your tomatoes, vegetables and more. Made from fresh fish, seaweed, molasses, yucca extract and humic acids, this formula was uniquely designed for plants with intense vegetative growth. Made with organic ingredients including fish, seaweed, etc.



Item #	Desc	UPC	Vendor	CS/UOS	Location
80120059	18 oz.	081435718128	TV 118	12/12	National
80120043	36 oz.	081435736122	TV 136	12/12	National

Rose & Flowering 2-6-4

Rose & Flowering fertilizer was uniquely formulated for flowering plants to increase their vigor during flowering and to increase the volume and density of buds that produce healthy, vibrant flowers. Made with fresh fish, molasses, yucca extract, seaweed and humic acids our Rose & Flowering formula will ensure that your plants are healthy and happy, produce lush foliage and maximize their flowering ability! Made with organic ingredients including fish, seaweed, etc.



Item #	Desc	UPC	Vendor	CS/UOS	Location
80120044	36 oz.	081435836129	RF 136	12/12	National

Crab & Lobster Shell 5-3-0

It is an excellent dry organic source of NPK, calcium (23%) and magnesium (1.33%). Crab shell is high in chitin, which promotes the growth of chitin eating bacteria in the soil. When crab shell is added to the soil it helps to create a hostile environment for the fungus and nematodes by feeding the biological life. It will help eliminate ants, grubs, fungus and root nematodes, because they are all chitin based in structure. Put around plants, crab shell will keep slugs and snails off. It also helps choke out weeds and keep moles, voles, mice, etc from digging up bulbs and root vegetables.



Item #	Desc	UPC	Vendor	CS/UOS	Location
80120006	4 lb.	081435506046	CS 604	6/6	National

Kelp Meal 1-0-2

It is dried and ground Rock Weed (Ascophyllum Nodosum). It is full of trace Minerals, Carbohydrates and Amino Acids, which help create a strong root systems and makes a very healthy plant. It should be tilled in the soil before planting or can be top dressed, incorporated into potting soils, seed beds and composting material. It will add organic matter to your soil and help it retain moisture. Kelp Meal will keep your lawn healthy and green, and shows great results on all plants.



Item #	Desc	UPC	Vendor	CS/UOS	Location
80120005	4 lb.	081435406049	KM 604	6/6	National



SIMPLE YET SCIENTIFIC

The Plant-Prod MJ™ line of fertilizers was designed to bring our 70 years of experience to the cannabis growers of today. Plant-Prod is excited to provide licensed growers of medical marijuana products that are scientifically optimized, consistent and completely soluble.

Grow 12-8-26

This ideal ratio of nitrogen, phosphorus and potassium promotes optimal growth to ensure a sufficient plant structure to support target yields. The added magnesium ensures no signs of deficiency. Grow contains an enhanced micronutrient package with additional EDDHA iron to ensure efficient uptake at a wide range of pH levels.

Item #	Desc	UPC	Vendor	CS/UOS	Location
81970001	4.4 lb	69889123194	12319	6/6	East

Bloom 10-30-20

This essential formulation is high in phosphorus and moderate in potassium, encouraging full bud set and bud filling. The added magnesium ensures no signs of deficiency. Bloom also contains an enhanced micronutrient package with additional EDDHA iron to ensure efficient uptake at a wide range of pH levels.

Item #	Desc	UPC	Vendor	CS/UOS	Location
81970002	4.4 lb	69889123200	12320	6/6	East

Boost 15-30-15

This highly soluble formulation has a low salt index and contains no sulphates or harmful chlorides, making it a very safe fertilizer for young transplants to initiate rapid root development. When plants are of a sufficient level of maturity or when buds are pea sized, feeding with 15-30-15 provides a boost of phosphorus to promote vigorous bud setting and sizing.

Item #	Desc	UPC	Vendor	CS/UOS	Location
81970003	4.4 lb	069889123217	12321	6/6	East

Spike (CaMg)

The absence of nitrogen, phosphorus and potassium allows the use of this formulation at any stage of production without the risk of encouraging vegetative growth when undesired. Ideal for use with reverse osmosis (RO) or city water when calcium and magnesium levels are usually low. Use should be limited to 2 feedings per week at supplemental rates.

Item #	Desc	UPC	Vendor	CS/UOS	Location
81970004	.77 lb	069889123897	12389	12/12	East

Finisher 4-31-37

This finishing formulation encourages fullness and density. During the last few weeks of production, the elevated potassium supports plant turgidity and disease resistance, while the phosphorus optimizes photosynthesis. The added nitrogen ensures no signs of deficiency. Feed during final weeks of fertilization, followed by clear water prior to harvest.

Item #	Desc	UPC	Vendor	CS/UOS	Location
81970005	4.4 lb	069889123231	12323	6/6	East



Continuous Release Plant Food

Unique 15-7-15 NPK ratio designed specifically by Proven Winners to maximize flowering and plant growth. Feeds plants for 6-months with only one application.



Item #	Desc	UPC	Vendor	CS/UOS	Location
81000003	2 oz Packet	064277800022	3101011.OZ02P	200/200	National
81000002	2 1/2 lb.	064277800251	3101011.LB02.5P	12/12	National

Water Soluble Plant Food

Unique 24-12-17 NPK ratio designed specifically by Proven Winners to maximize flowering and plant growth. Only consumer plant food which includes Iron in the important EDDHA form designed to keep plants green at varying pH ranges.



Item #	Desc	UPC	Vendor	CS/UOS	Location
81000001	2.5 lb.	064277801258	3101010.LB02.5P	12/12	National



Plant Food Plus™ 10-15-10

Liquid plant food feeds both indoor and outdoor plants. Provides vital micronutrients every time and encourages new plant growth.



Item #	Desc	UPC	Vendor	CS/UOS	Location
80050062	4 oz.	089146901075	SPF45160	12/12	National
80050065	32 oz.	089146901099	SPF45180	8/8	National

All Purpose Extended Feed Plant Food 19-6-12

Great for all indoor and outdoor plants. Feeds continuously for up to 6 months. The slow release of nutrients virtually eliminates the chance of overfeeding. Instead, your plants get the nutrition they need when they need it.



Item #	Desc	UPC	Vendor	CS/UOS	Location
80050075	1 lb	089146901112	SPF48790	12/12	National
80050076	2 lb	089146900986	SPF48800	6/6	National

All Purpose Slow Release Plant Food 16-12-12

Granular plant food for flowers, vegetables, and gardens. Easy-to-use slow-release formula that feeds up to 3 months.



Item #	Desc	UPC	Vendor	CS/UOS	Location
80050078	3.5 lb	089146900887	SPF48640	6/6	National

Plant Food Plus™ 20-20-20

All Purpose Plant Food encourages new growth and is ideal for both indoor and outdoor plants. It's easy to use and does not require mixing. It contains specific and important micronutrients that help ensure rapid growth, brighter coloring, better formations and overall healthier plants with strong root systems.



Item #	Desc	UPC	Vendor	CS/UOS	Location
80050068	1.5 lb	089146901006	SPF70680	6/6	National
80050069	5 lb	089146901013	SPF70690	6/6	National

Cactus Plus™ Liquid Plant Food

4 oz. Schultz® Cactus food makes feeding easier. Place 7 drops in one quart of water to feed every time you water. Good for all cacti and other succulents, jade, and aloe vera. Feeds through the roots. Contains micronutrients.



Item #	Desc	UPC	Vendor	CS/UOS	Location
80050086	4 oz.	089146901044	SPF44300	12/12	National

Tomato Food 17-18-28

Tomato & Vegetable Water Soluble Plant Food, grows delicious tomatoes, vegetables & fruits, feeds like nature by dissolving nutrients & vital micro nutrients evenly when it rains.



Item #	Desc	UPC	Vendor	CS/UOS	Location
80050071	1.5 lb	089146900979	SPF70370	6/6	National

Azalea, Camellia, Rhododendron Plant Food 32-10-10

Schultz azalea, camellia, rhododendron plant food has outstanding results for all acid-loving plants made up of a concentrated formula that contains vital micronutrients, Schultz plant food “feeds like nature” by dissolving nutrients evenly every time it rains. Grow bigger, brighter, fuller, healthier acid-loving plants.



Item #	Desc	UPC	Vendor	CS/UOS	Location
80050072	1.5 lb	089146901020	SPF70860	6/6	National

Bloom Plus Water Soluble Plant Food 10-54-10

Bloom Plus Fast Acting Water Soluble Plant Food is great for all outdoor blooming plants. It is convenient because it feeds like nature by dissolving nutrients every time it rains. It starts working instantly for fast and beautiful results. Made up of a concentrated formula that contains vital micronutrients, your plants get the nutrition they need, when they need it. Bloom Plus helps grow and support big, beautiful blooms.



Item #	Desc	UPC	Vendor	CS/UOS	Location
80050070	1.5 lb	089146900948	SPF70130	6/6	National



Liquid Plant Shine

Schultz Original 12oz Plant Shine leaf polish promotes shiny leaves. Because it's water-based and contains no oils, it will not clog plant pores and instead allows plants to breathe. It's easy to use, with a simple spray application.



Item #	Desc	UPC	Vendor	CS/UOS	Location
80050088	12 oz.	089146901105	SPF44000	8/8	National

Orchid Food 20-20-15

Helps grow healthier and more beautiful Orchids. Water soluble formula that contains vital micronutrients.



Item #	Desc	UPC	Vendor	CS/UOS	Location
80050097	4 oz	089146903628	SPF44600	12/12	National
80050067	10 oz	089146900993	SPF70600	12/12	National

Flower & Vegetable Extended Feed Plant Food 14-14-14

Contains slow-release nutrients your garden needs. Feeds flowers, fruits, and vegetables up to 6 months.



Item #	Desc	UPC	Vendor	CS/UOS	Location
80050077	2 lb	089146900955	SPF48300	6/6	National



Soil Moist™ Mycorrhiza Container Mix Plus

Contains beneficial endo-mycorrhizal fungi from 7 species that are adapted to a wide range of plants and habitat conditions. An 8-9 month timed release fertilizer and Soil Moist™ water storing polymer is included. The ultimate choice for planting flower boxes, hanging baskets & patio pots. Treats 20-1 gal containers, or up to 50 sq. ft.



Item #	Desc	UPC	Vendor	CS/UOS	Location
80040214	8 oz.	030541000696	JCD-05CMP	12/12	National

Soil Moist™

Soil Moist has been developed to reduce the amount of watering needed to maintain vigorous, healthy plants. Soil Moist is safe to use in all landscape and gardening situations, including vegetable gardens. When mixed in the soil, the Soil Moist crystals will soften and swell as water is added and absorbed. The polymer acts as a water reservoir, releasing water to the plant as the surrounding soil dries.



Item #	Desc	UPC	Vendor	CS/UOS	Location
80040001	1 lb.	030541010305	JCD-100SMJ	6/6	National
80040002	3 lb.	030541010343	JCD-030SM	6/6	National
80040004	3 oz. Display	030541010206	JCD-012SM	12/12	National
80040005	3 oz. Display	030541010206	JCD-024SM	24/24	National
80040006	8 oz.	030541010398	JCD-05SM	12/12	National

Soil Moist™ Flower & Garden Plus

Contains beneficial endo-mycorrhizal fungi from 7 species that are adapted to a wide range of plants and habitat conditions. An 8-9 month timed release fertilizer & Soil Moist water storing polymer is included in the mix. Ideal for planting in flower beds and gardens. Treats 40-1 gal. pots or 100 sq.



Item #	Desc	UPC	Vendor	CS/UOS	Location
80040212	1 lb.	030541000672	JCD-100FGP	6/6	National

Soil Moist™ Plus Spikes 5-5-5

Contains the Soil Moist™ copolymer blended with a three to four month timed release fertilizer. Ideal for indoor/outdoor plantings, especially in warmer, drier climates.



Item #	Desc	UPC	Vendor	CS/UOS	Location
80040007	24 pk display	030541010107	JCD-024SMP	24/24	National
80040014	12 pk display	030541010107	JCD-012SMP	12/12	National
80040008	24 pack clear spikes no fertilizer	030541012101	JCD-024SMS	24/24	National

Soil Moist™ Plant Paks

Now, no measuring, no mess! Plant Paks make it even more appealing by providing pre-measured Soil Moist™ in biodegradable "drop-in bags." Now plant watering and feeding couldn't be easier, quicker or neater.



Item #	Desc	UPC	Vendor	CS/UOS	Location
80040026	Shelf Unit	030541466881	SMP	12/12	National



Compost Tea Bags 4-6-4

All Natural. Designed for the avid organic gardener. This permeable fertilizer pack can be left to steep in a watering can overnight to make a Compost Tea brew for topical application.

Item #	Desc	UPC	Vendor	CS/UOS	Location
80950005	12 Bags/unit	031417001076	80-20-2005	10/10	East

4-6-4 Natural Organic Flower & Vegetable Plant Food

Promotes a rapid rate of vegetative establishment. Quick ground cover minimizes soil erosion and the need for repairs or re-seeding. Sustane replenishes the soil with a rich supply of humus (stabilized organic matter) and all of the essential nutrients required for quality growth.



Item #	Desc	UPC	Vendor	CS/UOS	Location
80950001	5 lb.	031417000437	80-20-1105	8/8	East
80950002	20 lb.	031417000468	80-20-1121	100/10	East

8-2-4 All Natural Plant Food For Organic Lawns & Landscapes

All Natural Slow Release Nitrogen Fertilizer provides 6 - 12 weeks of nitrogen in the organic slow release form. Sustane replenishes the soil with a rich supply of humus (stabilized organic matter) and all of the essential nutrients required for quality growth. This product provides a combination of plant nutrients and organic substances derived from biologically stable compost plus natural sulfate of potash and feather meal.



Item #	Desc	UPC	Vendor	CS/UOS	Location
80950003	5 lb.	003141700048	80-55-1105	8/8	East
80950004	20 lb.	031417000475	80-55-1121	10/100	East

Spring Weed & Feed Corn Gluten 9-0-0

Sustane 9-0-0 with non-GMO granular corn gluten meal with 15% Sustain fertilizer that performs as a natural broadleaf weed pre-emergent when used in spring. It is safe, easy to apply, and is blended with slow release nitrogen to help thicken lawns.



Item #	Desc	UPC	Vendor	CS/UOS	Location
80950007	30#	31417000550	80-60-1131	1/1	East



stops plants from drying out.



Anti Transpirant

Stops plants from drying out! Wilt-Pruf® uses a unique Moisture Lock Formula™ that is natural, organic, and provides layers of protection to keep your plants healthy year-round. Wilt-Pruf improves transplant success, protects against drought, and stops winter burn by holding in moisture on plant foliage and stems, substantially reducing water loss during periods of plant stress.

Item #	Desc	UPC	Vendor	CS/UOS	Location
80380001	32 oz. RTU	035951070000	WILT- PRUF 07000	12/12	National
80380002	16 oz. Con.	035951070079	WILT- PRUF 07007	12/12	National
80380003	32 oz. Con.	035951070093	WILT-PRUF 07009	12/12	National
80380004	1 gal. Con.	035951070116	WILT-PRUF 07011	4/1	National
80380005	5 gal.	035951070130	WILT-PRUF 07013	1/1	East

HIGH TECH MEDIA FOR HIGH TECH HYDROPONICS

Lettuce, herbs, veggies, cannabis and hemp are all popular hydroponic crops. Inert and stabilized media options are top choices for hydroponic systems. Find the perfect fit for your needs, including products from Grodan, Oasis and Jiffy.



GARDEN ACCESSORIES



CHECK OUT OUR CLEARANCE ITEMS!

DROP SHIP VENDORS

Esschert Design

FOB Thurmont, MD
\$100 minimum order
Under 3k order, 15% freight. Up to \$4,999 order, 10% freight. Up to \$7,499 order, 5% freight.
\$7,500+ = free freight
Oversized/overweight items are subject to additional freight charges
20% restocking Fee

Land & Sea

FOB Thurmont, MD
\$100 minimum order
Under 3k order, 15% freight. Up to \$4,999 order, 10% freight. Up to \$7,499 order, 5% freight.
Orders over \$7,500 = freight freight
Oversized/overweight items are subject to additional freight charges
20% restocking Fee

Red Carpet Studios

FOB Loveland, Ohio
\$250 minimum for garden catalog
\$150 minimum for fashion and holiday catalog
15% restocking fee

Boost Lifestyle Brands

Prepaid on \$2k order
Flat shipping rate of \$35 on orders less than \$2k

Radians

Prepaid freight \$1,250
Minimum \$100
15 day delivery window



Griffin Greenhouse Retail WAREHOUSE Shipping Map

We are now shipping nationwide!

NATIONAL



2025

Refer to location key:

National items are stocked nationally
 Select items are sold East or West only; no exceptions

8" Kaleidoscope Planter

Premium plastic modular planter can be displayed individually each planter has a removable saucer ideal for succulents or shallow rooted planted.

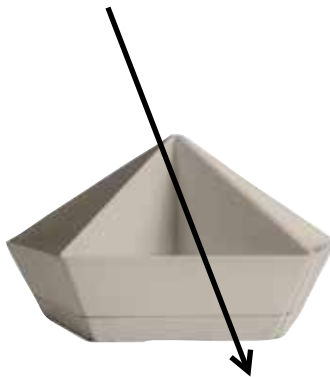

Item #	Desc	UPC	Vendor	CS/UOS	Location
80282643	Vanilla Bisque	770932844170	KDP08000A58	6/6	National

Where is the pricing?

1. Scan QR code on Chapter Pages to see pricing on Griffins.com
2. Contact your Griffin Sales Representative
3. Call into Griffin Customer Service 800.888.0054





FAIRY GARDEN KITS

Easily design a miniature garden scene and step into a world of fantasy. Fairy gardens are miniature gardens complete with structures and living plants limited only by the imagination. These kits include multiple handcrafted pieces and make it easy for children and adults to design unique and delightful gardens.



Charming Forest Fairy Garden Kit contains:

- (1) Owl
- (1) Enchanted Door
- (1) Fairy with Dove
- (1) Welcome Sign
- (3) Wayward Fences
- (1) Vine-Covered Arch
- (3) Stepping Stones

Item #	Desc	UPC	Vendor	CS/UOS	Location
80690703	Charming Forest	849637004759	FG33	12/12	East



Tea Party Fairy Garden Kit contains:

- (1) Tea Pot Cottage
- (1) Fairy with Tea
- (1) Tree Trunk Table
- (2) Tree Trunk Chairs
- (3) Lattice Fences
- (1) Welcome Sign
- (1) Tea Set
- (1) Pair Hedgehogs

Item #	Desc	UPC	Vendor	CS/UOS	Location
80690701	Tea Party	849637004735	FG31	12/12	East



Adoring Acorns Fairy Garden Kit contains:

- (1) Acorn House
- (1) Fairy with Acorn Hat
- (1) Acorn Bench
- (3) Log Fences
- (3) Birdhouse Stakes
- (1) Squirrel
- (1) Tree Slab Pathway

Item #	Desc	UPC	Vendor	CS/UOS	Location
80690702	Adoring Acorns	849637004742	FG32	12/12	East



Face of the Forest Resin Planter

Adding elements of fantasy and wonder to an area is easy with this durable planter for trees, walls, or fences. Whether using the whimsical face-shaped planter as a decorative container for growing and displaying live plants, or as a tree spirit embellishment to enrich the imaginative tone of your outdoor space, this functional planter brings a sprinkle of merriment and a hint of tranquility.

Item #	Desc	UPC	Vendor	CS/UOS	Location
80691011	Willow 8" x 10.5"	849637009402	TF01	4/4	East
80691012	Elderberry 8" x 11.8"	849637009419	TF02	4/4	East
80691013	Hawthorn 7.5" x 11.8"	849637009426	TF03	4/4	East

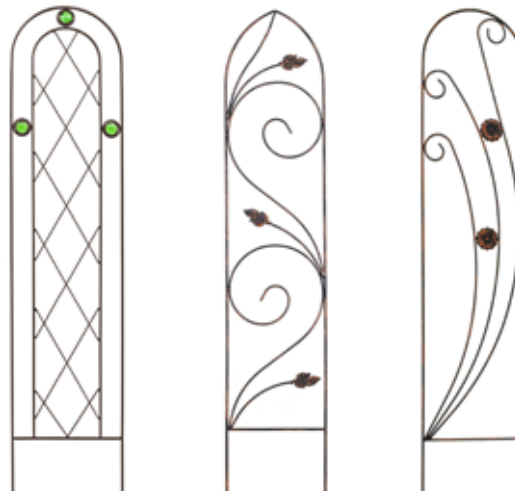

Emerald Series Lattice Trellis

Made of high-quality metal with a bronze-look finish, this trellis provides necessary plant support and is easy to use.

Item #	Desc	UPC	Vendor	CS/UOS	Location
80690481	4'x10"	813001018475	TR01	5/5	East

Autumn Leaf Trellis

Attractively supports and displays climbing plants, flowers and vines or can even be used alone as a decorative garden accent.

Item #	Desc	UPC	Vendor	CS/UOS	Location
80690486	6'x10" Bronze	813001018529	TR06	5/5	East

Phoenix Trellis

The rustic patina on the flower motifs enhances the garden charm of this planting accessory. Count on this trellis for the architectural support your climbing plants need.

Item #	Desc	UPC	Vendor	CS/UOS	Location
80690489	6'x10" Bronze	813001018550	TR09	5/5	East



Rain Chain

Enjoy the rain and sounds of falling water with this whimsical Rain Chain. It is designed for easy hanging as a vertical water feature or downspout with a gutter clip at the top of the chain.

Item #	Desc	UPC	Vendor	CS/UOS	Location
80690909	Birds 78.7" Length	849637007859	RC05	10/10	East
80690907	Watering Cans 78" length	849637006371	RC03	10/10	East

2025

Talon Bracket

Mount the brackets on a wall or column for hanging plants or other adornments. These powder coated metal brackets are resistant to all weather types and UV rays. Supports up to 25lbs

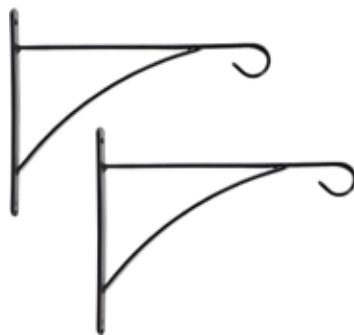

Item #	Desc	UPC	Vendor	CS/UOS	Location
80690162	12"	813001017454	BR05	5/5	East
80690163	16"	813001017461	BR06	5/5	East



14" Hanging Basket with Liner

14 inch matte black hanging basket with coco liner. 7" H x 14" W x 14" D



Item #	Desc	UPC	Vendor	CS/UOS	Location
82140207	14" Matte Black	095422000547	HBMB	6/6	National

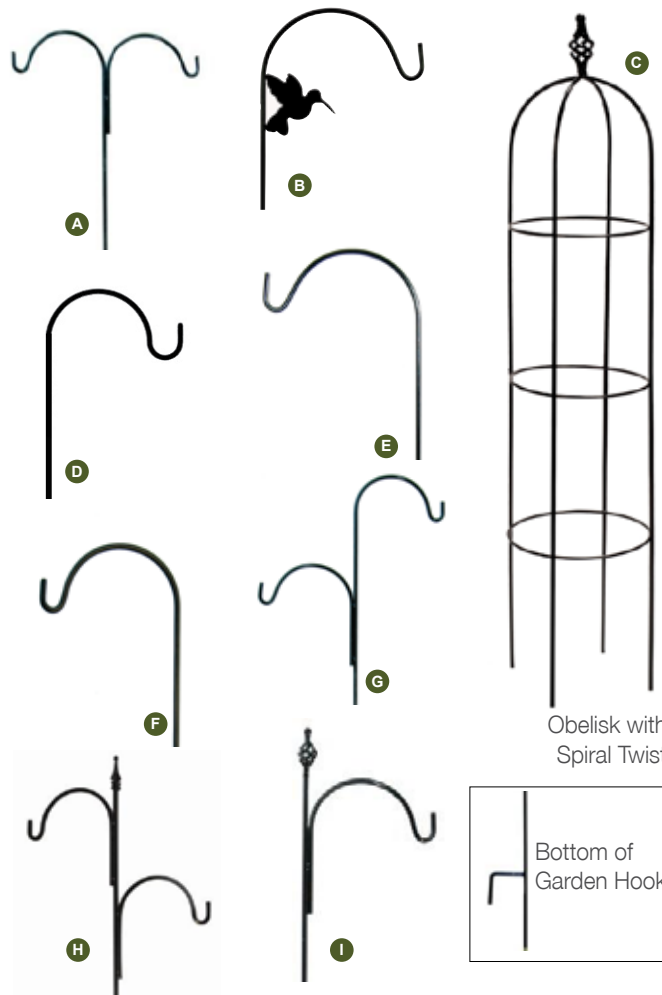

Garden Hooks

Item #	Desc	UPC	Vendor	CS/UOS	Location
82140097	A 90" Tall Double	095422000622	TD	10/10	National
82140102	B 65" Tall Floral Basket Hummingbird	095422993634	TFBHBB	10/10	National
82140060	C 54"x10.5"x10.5" Black Obelisk	095422994150	OST	4/4	National
82140061	C 54"x10.5" x10.5" Bronze Obelisk	095422994167	OSTBR	4/4	National
82140086	D 65" Short Single	095422000417	SS	10/10	National
82140142	Short Single	095422004583	UGSQSSMB	5/5	National
82140014	E 45" Floral Basket Feeder Hanger	095422480004	FBH	10/10	National
82140113	F 90" Tall Single	095422000615	TS	10/10	National
82140103	G 90" Tall Offset	095422000639	TOF	10/10	National
82140075	65" Short Offset	095422001438	SOF	10/10	National
82140082	H 90" Square Tall Offset w/ Finial	095422991739	SQTOF	5/5	National
82140089	I 65" Short Single w/ Spiral Twist	095422001469	SSST	5/5	National
82140084	90" Tall Single w/Finial	095422991982	SQTSF	5/5	National



Cathedral Trellis

Item #	Desc	UPC	Vendor	CS/UOS	Location
82140011	65"Hx25"W Black	095422994235	CT	10/10	National
82140012	65"Hx25"W Bronze	095422994242	CTBR	10/10	National

Scroll Trellis

Item #	Desc	UPC	Vendor	CS/UOS	Location
82140068	65"Hx25"W Black	095422994266	SCT	10/10	National
82140069	65"Hx25"W Bronze	095422994273	SCTBR	10/10	National

Arch Trellis

Item #	Desc	UPC	Vendor	CS/UOS	Location
82140001	65"Hx25"W Black	095422994297	AT	10/10	National
82140002	65"Hx25"W Bronze	095422994303	ATBR	10/10	National

Fan Trellis

Item #	Desc	UPC	Vendor	CS/UOS	Location
82140027	60"H x 24"W Black	095422991814	FTM	10/10	National
82140028	60"H x 24"W Bronze	095422991685	FTMBR	10/10	National

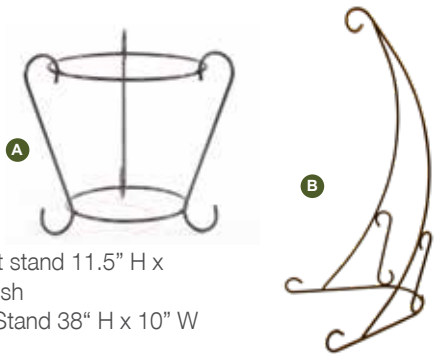

Plant Stand

(A) Reversible plant stand 11.5" H x 12.75" W black finish
 (B) Hanging Plant Stand 38" H x 10" W Bronze finish

Item #	Desc	UPC	Vendor	CS/UOS	Location
82140063	A Black	095422992514	PS-10	5/5	National
82140064	B Bronze	095422991609	PSBR	6/6	National

Filigree Plant Stand

Great decorative addition to your home or garden. Finished with a durable matte black weather-proof epoxy coating for long life



Item #	Desc	UPC	Vendor	CS/UOS	Location
82140024	12"H X 14"W	095422001810	FPS	4/4	National
82140025	20"H X 14"W	095422001841	FPST	4/4	National



Wonder GRIP for Kids!

Textured nitrile palm coating on an ultra-lightweight seamless nylon knitted glove in a size for children. Three assorted colors.



Item #	Desc	UPC	Vendor	CS/UOS	Location
80090215	XS	639751239652	KWG515ACXS	12/12	National

Wonder GRIP® Nicely Nimble™

Breathable, textured nitrile palm coating on a comfortable seamless 15-gauge nylon knit. Three assorted colors.



Item #	Desc	UPC	Vendor	CS/UOS	Location
80090269	Small	639751401813	WG515ACS	12/12	National
80090270	Medium	639751401820	WG515ACM	12/12	National
80090271	Large	639751401837	WG515ACL	12/12	National

Wonder GRIP® Nearly Naked®

Breathable, textured nitrile palm coating on an ultra-lightweight seamless 18-gauge nylon knit. Three assorted colors.



Item #	Desc	UPC	Vendor	CS/UOS	Location
80090237	XS	639751401554	WG1850ACXS	12/12	National
80090238	Small	639751401516	WG1850ACS	12/12	National
80090239	Medium	639751401523	WG1850ACM	12/12	National
80090240	Large	639751401530	WG1850ACL	12/12	National



Bellingham® Blue™ (A)

Premium, ergonomically shaped work glove. Tough, flexible, textured rubber palm. Anti-oxidation formula latex. Seamless knit liner. Great grip, wet or dry. Tapered fingertips improve fit and dexterity and stabilized yarn will not shrink even after repeated machine washing.

Item #	Desc	UPC	Vendor	CS/UOS	Location
80090003	Small	639751202113	C3000S	12/12	National
80090002	Medium	639751202120	C3000M	12/12	National
80090001	Large	639751202137	C3000L	12/12	National
80090004	X-Large	639751202144	C3000XL	12/12	National

Bellingham® Grey™ (B)

Premium comfort and protection. Thick looped acrylic liner insulates and cushions hands. Textured rubber palm. Construction 10 gauge acrylic/polyester knit liner, textured latex palm coating.

Item #	Desc	UPC	Vendor	CS/UOS	Location
80090015	Small	639751202519	C4510S	12/12	National
80090014	Medium	639751202526	C4510M	12/12	National
80090013	Large	639751202533	C4510L	12/12	National

Bamboo Gardener™ Rubber Palm (C)

Seamless knit bamboo liner keeps hands cool and comfortable. Natural rubber palm coat protects hands and enhances grip. 13-gauge rayon made from bamboo, polyester, polyurethane, and other materials.

Item #	Desc	UPC	Vendor	CS/UOS	Location
80090021	Small	639751530117	C5301S	12/12	National
80090020	Medium	639751530124	C5301M	12/12	National
80090019	Large	639751530131	C5301L	12/12	National

Thorn-resistant Gauntlet Gloves (D)

Canvas gauntlet protects forearms. Reinforced cowhide palm resists punctures and abrasion. Comfortable, reliable protection.

Item #	Desc	UPC	Vendor	CS/UOS	Location
80090506	Small	639751236811	C7352S	3/3	National
80090507	Medium	639751236828	C7352M	3/3	National

Bellingham® Nitrile TOUGH® (E)

Abrasion and puncture resistant nitrile coating molds to the hand. Fits like a second skin, wears like iron! Excellent dexterity; breathable seamless nylon knit liner. 13-gauge nylon knit liner.

Item #	Desc	UPC	Vendor	CS/UOS	Location
80090010	Small	639751137316	NT3700BKS	12/12	National
80090009	Medium	639751137323	NT3700BKM	12/12	National
80090008	Large	639751137330	NT3700BKL	12/12	National
80090011	X-Large	639751137347	NT3700BKXL	12/12	National

Wonder Grip® Extra Grip (F)

Features a double coated textured latex palm and a tough 13-gauge nylon knit. Extra grip reduces hand fatigue.

Item #	Desc	UPC	Vendor	CS/UOS	Location
80090029	Medium	639751400427	WG310M	12/12	National
80090028	Large	639751400434	WG310L	12/12	National

Bamboo Gardener™ Nitrile Palm (G)

Seamless knit bamboo liner keeps hands cool and comfortable. Nitrile palm coat resists punctures and abrasion. 13-gauge rayon made from bamboo, nylon, and lycra.

Item #	Desc	UPC	Vendor	CS/UOS	Location
80090018	Small	639751537116	C5371S	12/12	National
80090017	Medium	639751537123	C5371M	12/12	National
80090016	Large	639751537130	C5371L	12/12	National

Ladies Assorted Bamboo Gardener™ Nitrile Palm

Bamboo Gardener™ Nitrile Palm for Women Assorted Colors



Item #	Desc	UPC	Vendor	CS/UOS	Location
80092756	Ladies Small	674326374758	C5370ACS	12/12	National
80092755	Ladies Medium	674326374765	C5370ACM	12/12	National
80092754	Ladies Large	674326374772	C5370ACL	12/12	National

Gard Ware Nicely Nimble™

Breathable, textured nitrile palm coating on a comfortable seamless 15-gauge nylon knit. Three assorted colors.



Item #	Desc	UPC	Vendor	CS/UOS	Location
80091588	Small	674326333717	C515ACS	12/12	National
80091589	Medium	674326333724	C515ACM	12/12	National
80091590	Large	674326333731	C515ACL	12/12	National

Gard Ware Nearly Naked®

Ultra light weight 18 gauge nylon/spandex knit shell and durable, breathable single coated nitrile palm for excellent grip in wet or dry conditions. Three assorted colors



Item #	Desc	UPC	Vendor	CS/UOS	Location
80091568	Small	674326333755	C1850ACS	12/12	National
80091569	Medium	674326333762	C1850ACM	12/12	National
80091570	Large	674326333779	C1850ACL	12/12	National

EcoMaster® Nitrile Palm PTE Garden Gloves

13 gauge Eco-friendly Recycled PTE/Spandex Seamless Liner is soft and moisture wicking for a comfortable wear. Breathable micro-finish nitrile palm coating provides improved durability and grip. Available in 3 assorted colors.



Item #	Desc	UPC	Vendor	CS/UOS	Location
80092743	Small	674326370354	C3705ACS	12/12	National
80092744	Medium	674326370361	C3705ACM	12/12	National
80092745	Large	674326370378	C3705ACL	12/12	National

Exceptionally COOL™ Gloves for Women

Lightweight, 13-gauge nylon knit with breathable polyurethane palm coat; three assorted patterns.



Item #	Desc	UPC	Vendor	CS/UOS	Location
80090024	Small	639751236514	C2603APS	12/12	National
80090023	Medium	639751236521	C2603APM	12/12	National
80090022	Large	639751236538	C2603APL	12/12	National

Bellingham® Nitrile TOUCH®

Abrasion & puncture resistant nitrile coating molds to the hand. Fits like a second skin! Excellent dexterity; breathable seamless nylon knit liner, six assorted colors. LFS's top selling garden glove.



Item #	Desc	UPC	Vendor	CS/UOS	Location
80090007	Small	639751137217	NT3700ACS	12/12	National
80090006	Medium	639751137224	NT3700ACM	12/12	National
80090005	Large	639751137231	NT3700ACL	12/12	National

Kid Tuff Too™

These colorful, washable gloves will be instant winners with kids and the adults who like to buy things for them! Nylon knit with textured rubber palm, three assorted characters for each size.



Item #	Desc	UPC	Vendor	CS/UOS	Location
80090214	XS	639751237054	KT440ACXS	12/12	National
80090811	Toddler	639751237108	KT440ACT	12/12	National
80090812	XXS	639751237184	KT440ACXS	12/12	National

Ducky Glove for Kids

This glove is already making a splash. Bright yellow nylon knit with bright orange nitrile 3/4 dip coating. Kids can use it as a puppet, too. Durable, washable, and lots of fun!



Item #	Desc	UPC	Vendor	CS/UOS	Location
80090032	Kids	639751105254	C1052T	12/12	National

Women's Slip On Synthetic Leather Palm Gloves

Padded synthetic leather palm and reinforced fingertips add protection. Patterned hyprene back provides attractive comfort and flexibility. Three assorted colors.



Item #	Desc	UPC	Vendor	CS/UOS	Location
80090806	Small	639751213713	C7333ACS	6/6	National
80090807	Medium	639751213720	C7333ACM	6/6	National
80090808	Large	639751213737	C7333ACL	6/6	National



Thorn-Pro Goatskin Gauntlet

The Thorn-Pro C7365 is a goat skin leather palm glove with a gauntlet cowhide cuff. The extended gauntlet cuff offers protection against thorns, scrapes and other irritants.



Item #	Desc	UPC	Vendor	CS/UOS	Location
80092849	Small	674326385273	C7365S	6/6	National
80092848	Medium	674326385280	C7365M	6/6	National
80092847	Large	674326385297	C7365L	6/6	National
80092850	X-Large	674326385303	C7365XL	6/6	National

Ladies Insulated Goatskin Driver

The C90109i is a top-grain premium goatskin leather driver includes a 40g Thinsulate liner for cold weather protection. Supple yet water and abrasion-resistant without losing dexterity.



Item #	Desc	UPC	Vendor	CS/UOS	Location
80092853	Small	674326385358	C90109IS	6/6	National
80092852	Medium	674326385365	C90109IM	6/6	National
80092851	Large	674326385372	C90109IL	6/6	National

Women's Tuscany Performance™

Premium natural leather palm and fingertips. Leather is drum dyed, a natural finishing process with a softer feel. Breathable spandex back with embossed logo and shirred wrist. Three assorted colors



Item #	Desc	UPC	Vendor	CS/UOS	Location
80090777	Small	639751410419	C7784ACS	6/6	National
80090778	Medium	639751410426	C7784ACM	6/6	National

Thraxus Eyewear Amber

Vertical and horizontal maximum field of vision and protective coverage. Self-adjusting nose pads offer more adjustability, stability and comfort. Floating nose loop designed to be more adjustable and fit more comfortably.



Item #	Desc	UPC	Vendor	CS/UOS	Location
80092747	Eyewear	674326360386	TXC1-40CS	4/4	National



bloem



Pink Flamingos

Colorful, fade resistant with galvanized steel legs that will not rust. Two classic poses - head up (25"x20") and head down (22"x20"). Features fun googly, moving eyes.

Item #	Desc	UPC	Vendor	CS/UOS	Location
80920770	2 pc.	811214020599	G2	6/6	National



Mini Mingo

2 Pack - 2.8" W x 5.8" H
One of the most popular lawn and garden accessories from the 1950s is available from Bloem! Now your home can feature this icon of retro hipster cool. These Pink Flamingos are made from the highest quality plastic for all-weather durability. Whimsical googly eyes and sturdy metal legs. Creative packaging for retail display.

Item #	Desc	UPC	Vendor	CS/UOS	Location
80920774	2 pack.	811214020636	G52	12/12	National



BOSMERE

Tidy Potting Tray

Comfortably holds 3 full size seed trays and is an ideal water reservoir tray for numerous pots.



Item #	Desc	UPC	Vendor	CS/UOS	Location
82010102	24"X 21.5"X8"	5031670003522	N122	10/10	National

Wren Scroll Trellis

Perfect for popping into containers or in the garden to give blooms and foliage support. Heavy duty green plastic coated for long lasting durability.



Item #	Desc	UPC	Vendor	CS/UOS	Location
82010570	36" x 16"	600679001362	L530	6/6	National

Folding Kneeler Seat

Fitted with comfort pads on both seat and kneeler. Spring release allows Kneeler Seat to fold flat when not in use. Steel frame construction with a green powder coated finish, will last for years.



Item #	Desc	UPC	Vendor	CS/UOS	Location
82010024	24"X10"X19.5"	5013554144705	N470	3/3	National

16" Down Under Plant Turner

Plant saucer rotates to offer your plant the best exposure to sun for uniformed growth, supports 400lb.



Item #	Desc	UPC	Vendor	CS/UOS	Location
82010059	16"	641341416107	S41610	8/8	East



Down Under Plant Stand

The Bosmere Down Under Plant Stand prevents staining and rotting on all surfaces including decks, wood floors, carpet, tile or any other surface.

Item #	Desc	UPC	Vendor	CS/UOS	Location
82010685	12" Clear	641341104440	S10440	12/12	National
82010682	12" -Black	641341104103	S10410	12/12	National
82010684	12" -Terracotta	641341104301	S10430	12/12	West
82010683	12" -Forest Green	641341104202	S10420	12/12	West
82010738	12" -Light Gray	641341104509	S10450	12/12	West
82010688	16" -Clear	641341164404	S16440	12/12	West
82010686	16" -Black	641341164107	S16410	12/12	West
82010687	16" -Terracotta	641341164305	S16430	12/12	West

Pot Toes

Use Pot Toes to prevent stains and rotting on all surfaces including decks, wood floors, carpet, tile or any other surface. Easy to use, just slide the Bosmere Pot Toes under your pots or planters. Works on all pots or planters regardless of shape and size up to 500 lbs. Lifts your pots or planters up off the surface for ventilation which leads to healthier plants. Can also be used to level pots on an uneven surface.



Item #	Desc	UPC	Vendor	CS/UOS	Location
82010722	Terracotta	180629000114	S06TCCS	24/24	West
82010721	Dark Gray	180629000121	S06DGCS	24/24	National

Permanent 4-Inch Long Copper Tags with Copper Ties

These labels provide an inconspicuous way to label shrubs and trees. Use for recording the name of plant, date planted, the source of the shrub, color, etc. The copper face of the tag will darken over time and develop a nice patina.



Item #	Desc	UPC	Vendor	CS/UOS	Location
82010662	4" X 0.75"	721082081885	H188	12/12	National

BOSMERE

Down Under Plant Caddie

Our Plant Caddie is made of heavy duty, UV resistant plastic. Supports up to 500 lbs if planter is positioned evenly over wheels. Hole in the middle of the Plant Caddie helps your pots and planters drain properly to maintain healthy plants. Has 6 high quality wheels and 2 locking casters to help keep your caddie in place.



Light Gray

Item #	Desc	UPC	Vendor	CS/UOS	Location
82010246	14" - Black	641341144109	S14410	6/6	National
82010247	16" - Black	641341184105	S18410	6/6	National
82010248	20" - Black	641341204100	S20410	6/6	National
82010094	14" - Terra	641341144307	S14430	6/6	National
82010739	14" - Light Gray	641341144505	S14450	6/6	West
82010095	16" - Terra	641341184303	S18430	6/6	National
82010096	20" - Terra	641341204308	S20430	6/6	East

2025

Glazed Ceramic Copper Toadstools Decorative Garden Stakes

The beautiful Glazed Ceramic Copper Toadstools Decorative Garden Stakes (3-Piece Set) will add charm and whimsy to any garden. The lovely freeze-proof toadstools "tinkle" in the wind as the tops move against the stems. These shiny copper colored stakes will brighten up your garden and can be used in the ground and in planters or pots. Set of 3 - (1) 12" and (2) 10".



Item #	Desc	UPC	Vendor	CS/UOS	Location
82010599	Set of 3	721082231201	W120	6/6	National

Ceramic Lawn Ornament Toadstools Decorative Garden Stakes

This beautifully glazed, freeze-proof ceramic toadstool tinkles in the wind as the tops move against the stems. Set of 3 - (1) 12" and (2) 10".



Item #	Desc	UPC	Vendor	CS/UOS	Location
82010596	Set of 3	5060072571230	W117	6/6	National

BosNeeleeze Luxury Garden Kneeler

The BosNeeleeze Luxury Garden Kneeler provides the ultimate comfort to your knees while carrying out weeding, planting and other tasks where you need to kneel down. It is light weight and has a carry handle to make it easy to carry around. It is waterproof to keep your knees dry in wet conditions. It has a durable quick dry neoprene outer skin with a memory foam cushion inner. When it gets dirty you can wipe it clean with a damp sponge. Assorted case red, blue, green, and purple.



Item #	Desc	UPC	Vendor	CS/UOS	Location
82010037	Assorted Colors	5013554201005	G125	6/6	National

bond

Bamboo Torches

Classic Bamboo Torch with refillable fuel canister, fiberglass wick and fire retardant finish. Includes corrugated display box. Metal fuel canister can be filled with Citronella oil to help repel flying insects and mosquitoes.



Item #	Desc	UPC	Vendor	CS/UOS	Location
80340884	5' Napali	034613026171	Y2617A	48/48	East

CHG

Classic Home & Garden

4-Arm Plant Stand

The 4-Arm Hanging Basket Plant Stand is a dramatic way to display hanging baskets. The decorative stand takes just a couple of minutes to set up without tools. Foldable, storable and lightweight, the stand is made to endure all seasons of weather. 26.5" X 26.5" X 64.5" tall



Item #	Desc	Vendor	CS/UOS	Location
81792138	Black	H18003	1/1	National



*Made of plastic resin

Fountains

Fountain comes equipped with pump.

Item #	Desc	Vendor	CS/UOS	Location
81791865	A Dorset Sprh Verdigris 25.6" x 15.8" x 23.6"	11006-VG	1/1	East
81791498	B Surrey Sprh Burnt Umber 15.75"x15.75x31.75	11031-BU	1/1	East
81792393	C Charleston Birdbath LED Lighting 15.94" x 15.94" x 26.77"	11211-054	1/1	National
81792445	D Beverly Birdbath White LED Lighting 23.6" x 23.6" x 46.3"	11217-054	1/1	National
81792395	E Cascade LED Lighting 20.1" x 16.3" x 28"	11213-518	1/1	National
81792397	F Versailles 14.2" x 14.8" x 24.9"	11218-054	1/1	East
81792399	G Savannah LED Lighting 14" x 13.2" x 25.8" Blue	11214-136	1/1	National
81792446	H Savannah LED Lighting 14" x 13.2" x 25.8" White	11214-054	1/1	National

Rain Chain



Item #	Desc	UPC	Vendor	CS/UOS	Location
81792148	Umbrella 4x4x60	766282809839	44002	8/8	East
81792146	Flower 4x4x60	766282809815	44000	18/18	National

Antique Green Plant Shelf



Item #	Desc	Vendor	CS/UOS	Location
81791852	30x23.6x24.8	42001	2/2	East

2025

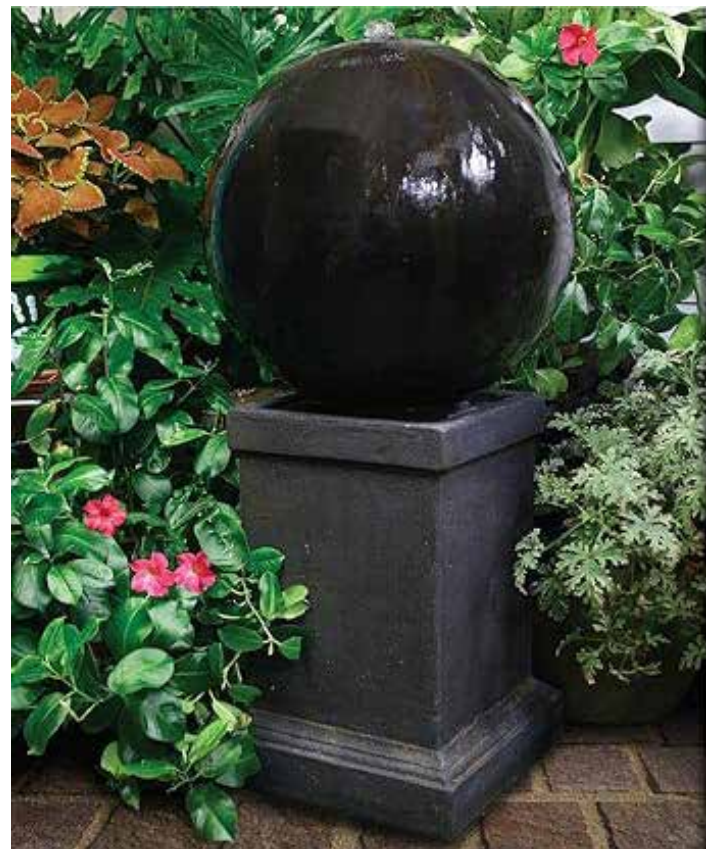



Inflatable Snake

The Natural Enemy Scarecrow Inflatable Snake is 6' long and helps reduce fruit tree and vegetable crop loss by up to 50%. This realistic inflatable snake is especially effective against birds and can be used on decks, in gardens, pools, barns, boathouses, docks, etc.



Item #	Desc	UPC	Vendor	CS/UOS	Location
82170041	6' Shelf Display	016069000011	NE-SR	12/12	National

Holographic Scare Tape

Reflective scare tape keeps your gardens safe from those crooked birds as its shifting holograms will shimmer beautifully in sunlight, disorienting and scaring them off.



Item #	Desc	UPC	Vendor	CS/UOS	Location
82170159	3/4" x 100' Roll	016069006792	HST-100CN	12/12	National

Harvest Guard

The Harvest Guard Premium Blanket offers reliable protection against frost, wind, and pests, ensuring the optimal growth and health of your plants. Its generous size provides ample coverage, allowing you to shield a large area of your garden or agricultural field.



Item #	Desc	UPC	Vendor	CS/UOS	Location
82170074	5' x 25'	016069000325	HG-25	12/12	National

Tree Wrap

Tree trunk wrap keeps trees safe from the extremes of winter and summer.



Item #	Desc	UPC	Vendor	CS/UOS	Location
82170062	3" x 50'	016069000608	RAP-15	15/15	West

Great Horned Hand Painted Owl

This Natural Enemy Scarecrow® deters pests from your yard and gardens. With its realistic design, Gardener's Great Horned Owl is the perfect deterrent device. This chemical-free device safely deters birds and unwanted pests and protects your dock, deck or boat. The hand-painted life-like design makes it look realistic and attractive to use in any place that needs some pest control.



Item #	Desc	UPC	Vendor	CS/UOS	Location
82170038	16"	016069000301	OW-6	6/6	National



RIVER NORTH COLLECTION

Made from heavy gauge wire | Holds pots up to 12"

*All plant stands come with plastic trays.



Item #	Desc	UPC	Vendor	CS/UOS	Location
81920190	13"	635483011030	RN103B	6/6	National
81920191	21"	635483011047	RN104B	6/6	National
81920192	27"	635483011054	RN105B	6/6	National
81920195	2 Tier	635483011085	RN108B	1/1	East
81920193	63"x 18"	635483011061	RN106B	1/1	East



Arch Top Topiaries

Small: 11"x11"x30"
 Medium: 12.5"x12.5"x42"
 Large: 14"x14"x60"

2 sets of three per case

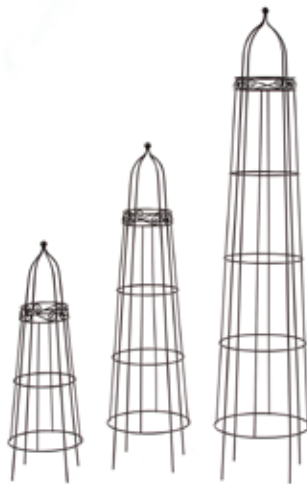

Item #	Desc	UPC	Vendor	CS/UOS	Location
81920355	S, M, L	702085410698	RN203SETB	2/2	East

Premium Shepherds Plant Support - Black

Hang your favorite potted blooms from the extremely sturdy Deer Park Ironworks Premium Shepherds Hook Plant Support. Constructed of 5/8" solid steel and featuring a classic black powder-coated finish, your search is over to replace those flimsy shepherd hooks on the market today. All shepherd hooks come with 12" double ground stake and will anchor securely. Comes in your choice of available sizes.



Item #	Desc	UPC	Vendor	CS/UOS	Location
81920359	36" x 5/8"	702085410735	RN204SB	4/4	East
81920358	60" x 5/8"	702085410742	RN204MB	4/4	East
81920357	72" x 5/8"	702085410759	RN204LB	4/4	East
81920356	72" x5/8" Dbl	702085410766	RN204DBLB	2/2	National

Classic 3 Shelf Plant Stand

This plant stand sports a powder-coated finish that protects it from rust and other forms of corrosion. Three modular hanging pot holders outfit it. *Does not come with pots or plants pictured



Item #	Desc	UPC	Vendor	CS/UOS	Location
81920201	32"W x 16"D x 53"H	635483011238	RN123B	1/1	East

2 Tier Rectangular Plant Stand

Black powder-coated steel, easy assembly. Measures 27"W x 13"(D) x 31"(H). Holds up to (2) 12" pots.



Item #	Desc	UPC	Vendor	CS/UOS	Location
81920189	2 tier	00635483011016	RN101B	1/1	East

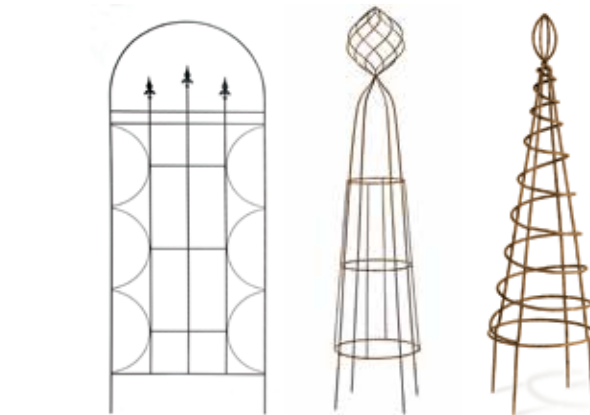

Steel Finial Trellis - Black

Give your favorite flowers and plants the support they need to grow with the Deer Park Ironworks Steel Finial Trellis. Constructed of durable steel and featuring a classic black powder-coated finish adorned with 3 fleur-de-lis, this trellis will be the focal point in your backyard or garden.

Item #	Desc	UPC	Vendor	CS/UOS	Location
81920354	48" X 18"	702085410667	RN202SB	4/4	East

Firecracker Ball Topiary

Deer Park's Large Fire Cracker w/Ball Topiary is made of solid steel with a durable powder-coated finish that gives it a natural patina appearance. This topiary can function as a decorative piece or functional for climbing plants. Dimensions are 15" Diam. X 60"H plus stakes.

Item #	Desc	UPC	Vendor	CS/UOS	Location
81920221	Tall 15" Diam. x 43"H + stakes	702085403102	TO102	4/4	East

Spiral Topiary

The Spiral Topiary Planter is made with baked on powder coated finish for lasting durability. The unique finial top design adds a visual accent to flower or herb gardens. Climbing plants love to creep up the spiral frame.

Item #	Desc	UPC	Vendor	CS/UOS	Location
81920223	14" Diam. x 43"H + stakes	702085403379	TO103	4/4	National
81920225	16" Diam. x 55"H + stakes	702085403386	TO104	4/4	National



Tea Cart

Deer Park Tea Cart features a natural patina appearance. Heavy gauge metal construction; baked-on, powder-coated finish. 30"L x 17"W x 30"H



Item #	Desc	UPC	Vendor	CS/UOS	Location
81920211	Natural Patina	702085400309	TC101	1/1	East



Lattice Plant Stand - Black

Deer Park's Lattice Plant Stand is made of durable steel and is powder-coated for long lasting outdoor or indoor use.

Item #	Desc	UPC	Vendor	CS/UOS	Location
81920362	16" x 15"	702085410810	RN206SB	6/6	National
81920361	21" x 15"	702085410827	RN206MB	6/6	National
81920360	27" x 15"	702085410834	RN206LB	6/6	National



Landscape Fabric Biodegradable Paper

The Garden Weed Barrier - Economical, light-weight paper mulch that helps control weeds and is 100% organic. Made from premium recycled paper, DeWitt Garden Weed-Barrier® is chemical free - making it approved for organic food production.



Item #	Desc	UPC	Vendor	CS/UOS	Location
80010023	3' X 40'	042579819928	NAT340	12/12	National

Plastic Pound-In Edging

Decorative interlocking scroll edging provides for landscaping design flexibility. Rubber mallet is only tool needed. 10' Pound In Edging includes 20 - 6" pieces.



Item #	Desc	UPC	Vendor	CS/UOS	Location
80010237	10'	022401100851	VPI-10	6/6	National



Kneeling Pad

Are you having to kneel down on hard solid ground while doing physical labor? Made in America, Earth Edge Pads measure 15"x20"x1" and comes in a convenient retail ready display.



Item #	Desc	UPC	Vendor	CS/UOS	Location
82690002	10 Pack	817666020019	EE000261-10	10/10	National
82690001	30 Pack	817666020019	EE000261-30	30/30	National

Body Pad

With the Earth Edge Body Pad, you can work anywhere you need to remain on your back for as long as necessary without feeling stiff and sore during and after your project is completed. The Body Pad is 18"x40"x3/4" thick, giving you more room to work with ultimate comfort.



Item #	Desc	UPC	Vendor	CS/UOS	Location
82690025	10 Pack	817666020125	EE000125	10/10	National

- GRIFFIN GAZETTE -

Published especially for top customers, the Griffin Gazette is loaded with news you can really use. Our team serves up timely production advice, retail inspiration, and product and variety information to help you bring your best crop to market. Check out the digital Gazette for exclusive bonus content not available in print!

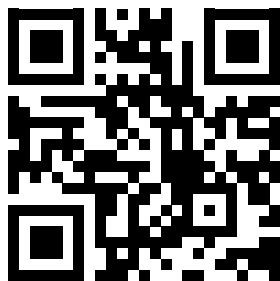

Visit <https://www.griffins.com/custom-site/publications> to browse the Gazette archives!



Super Cushy Kneeling Pad

The Super Cushy Pad 15 in. x 20 in. x 2 in. is a premium super thick 2 in. pad for kneeling and sitting on any hard surface! For those that have bad knees and need the extra cushion, The Super Cushy Pad will keep you comfortable. The black NBR Foam acts similar to memory foam, is water resistant, mold and mildew resistant, and washes off with water.



Item #	Desc	UPC	Vendor	CS/UOS	Location
82690004	5 Pack	817666020026	EE000926-05	5/5	National
82690003	15 Pack	817666020026	EE000926-15	15/15	National

Mossy Oak Kneeling Pad

The Mossy Oak kneeling pads are great for those who love the outdoors! Since the kneeling pads float, not only are they suitable for dry environments but they can also be used as seat cushions in all types of watercraft. Great for a steel pan tractor seat, on a hard shop floor, as a butt saver on a low rolling thinly-padded shop stool. 15" x 20" x 1"



Item #	Desc	UPC	Vendor	CS/UOS	Location
82690029	10 Pack Oceanic Blue	817666020248	EE000248-10	10/10	National
82690027	10 Pack Camo	817666020231	EE000231-10	10/10	National

Anti-Fatigue Mat

The ComfortBOOST ultimate anti-stress mat has been proven to reduce back and leg strain by as much as 54.86%. Built tough for commercial and industrial applications, users will FEEL an immediate difference and employers will notice an increase in productivity.



Item #	Desc	UPC	Vendor	CS/UOS	Location
82690006	2'x3'x3/4"	817666020187	EE000187	1/1	National
82690007	3'x5'x3/4"	817666020194	EE000188	1/1	National



Tree Banding Gum

Treekote Tree Banding Gum provides an effective barrier against crawling insects such as gypsy moth and tent caterpillars, ants, obscure root and pecan weevils, tussock moth caterpillars, climbing cutworms and canker-worms just to name a few!



Item #	Desc	UPC	Vendor	CS/UOS	Location
80470188	15oz. Tub	050699007163	300716	12/12	National



4" WindyWings Butterfly

Unique figures on stakes that have wings that move up and down to simulate flight when a breeze is blowing. Beautifully hand painted figures constructed of UV coated plastic for long life. Lacquer coated for a high gloss shine. Assorted 4in Butterflies, 16" H with stake, 12 designs



Item #	Desc	UPC	Vendor	CS/UOS	Location
80870052	24pc assortment	093335051083	5108	24/24	National

Solar Double Spinner Wind Chime

Enjoy the relaxing sounds of these beautiful wind chimes as a gentle breeze passes through the hand-painted designs. The chimes will sing as double spinner twirls in two directions, adding music, color, and motion to your home. Makes a wonderful addition to your patio, yard, or garden and is an impressive gift for the garden enthusiast!



Item #	Desc	UPC	Vendor	CS/UOS	Location
80871615	16"x4.5"x42" Cardinal	093335721900	72190-RS	1/1	National
80871619	14"x4.5"x42" Butterfly	093335721870	72187-RS	1/1	National

WindyWings Whirligigs

Add fun, color and movement to your garden or anywhere with this beautiful, assorted garden stakes display. 3.5"L x 7"W x 28.75"H



Item #	Desc	UPC	Vendor	CS/UOS	Location
80870513	24pc assortment	093335506071	50607	24/24	East

4" WindyWings™ Mixed Assorted Shelf Display

Each stake is 13" tall. 24 piece mixed assortment in a plastic pot display. Includes (6 each): 4" butterflies, 4" dragonflies, 4" hummingbirds and 4" song birds. Comes fully assembled. Already positioned in a plastic pot. 95% plastic and 10% metal. 6" x 4.5" x 16"



Item #	Desc	UPC	Vendor	CS/UOS	Location
80870001	24pc assortment	093335050352	5035	24/24	National

WindyWings Dragonfly

Enjoy watching the translucent wings and bright body of a beautiful Dragonfly Garden Stake shine! With a simple breeze, the WindyWings will gently flutter simulating flight. Wherever this enchanting creature lands, it will stay, adding color and life to your garden. 6" x 4" x 15.5"



Item #	Desc	UPC	Vendor	CS/UOS	Location
80870056	24pc assortment	093335052424	5242	24/24	National

7" WindyWings Assorted Wind Chimes

The vivid bright hues, the lovely sounds of the soothing chimes through the gentle breeze, and the "springed" wings that add whimsical motion, make this beautiful piece of garden art a delightful decorative accent to any home or yard! Hand painted with a special lacquer coating to protect the colors and provide a high-gloss shine. 4"x 8"x 21".



Item #	Desc	UPC	Vendor	CS/UOS	Location
80870436	24pc assortment	093335401048	40104	24/24	National

Patriotic Windy Wings

Add a touch of spirit into your patriotic garden. You will love the WindyWings Americana garden stake assortment! 4" x 4" x 16"



Item #	Desc	UPC	Vendor	CS/UOS	Location
80871218	24pc assortment	093335054527	5452	24/24	National

Windy Wings Hummingbirds

This winged hummingbird on a tall stake is made from styrene plastic that is hand painted and UV treated. 8.9" X 7.3" X 28.7"



Item #	Desc	UPC	Vendor	CS/UOS	Location
80870473	24pc assortment	093335502066	50206	24/24	National

7" WindyWings Butterfly Garden Stakes

Unique figures on stakes that have wings the move with the breeze. Beautiful, hand-painted garden stakes with UV-coated plastic and a lacquer finish for high gloss. 7"L X 7" W X 30"H



Item #	Desc	UPC	Vendor	CS/UOS	Location
80870470	24 pc. assortment	093335502011	50201	24/24	National

Ruby Red Throat Hummingbird

The beautiful wings gently flutter in the breeze, and the built in solar panel will charge in the sun and automatically glow at night!



Item #	Desc	UPC	Vendor	CS/UOS	Location
80871332	6" x 4" x 18" 24 PC	093335058389	5838	24/24	National

Solar Gnome W/ Flower Hat

Solar powered LEDs provide an enchanting glow at dusk. Add instant charm and whimsy to your garden. made of durable resin for all season UV treated to resist fading 7.0" x 6.0" x 11.5"



Item #	Desc	UPC	Vendor	CS/UOS	Location
80871353	Gnome Statue	093335185917	18591-RS	6/6	National

Eagle on a USA Flag Garden Statue

This stunning Bald Eagle Garden Statue with an American Flag detail will add a patriotic touch to your home or garden. Beautifully hand painted with great attention to detail and coated to withstand the elements outside, this elegant piece makes a proud addition to your home or garden. Enjoy indoors or out, UV treated to resist fading. Made of durable weather resistant resin 9.5" x 8.0" x 17.5"



Item #	Desc	UPC	Vendor	CS/UOS	Location
80871627	Eagle	093335172436	17243-RS	1/1	National

Solar Garden Frog

An adorable frog and his jar full of sparkling LED fireflies adds a touch of childlike innocence and wonder to your garden. 6.0" x 7.5" x 11.0"



Item #	Desc	UPC	Vendor	CS/UOS	Location
80871025	Solar Frog	093335120727	12072-RS	1/1	National

Smoking Gnome Statues

This adorable gnome's bud garden will illuminate each night at your desired time. Simply set the battery timer and enjoy this handcrafted fun loving progressive home decor indoors or out! 5.0" x 5.5" x 12.5"



Item #	Desc	UPC	Vendor	CS/UOS	Location
80871259	Smoking Gnome Statue	093335157402	15740-RS	1/1	National

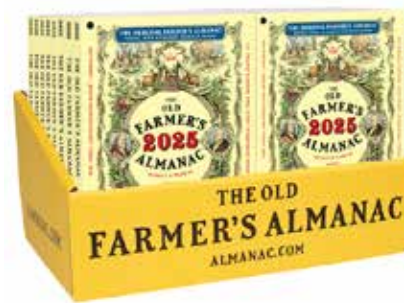
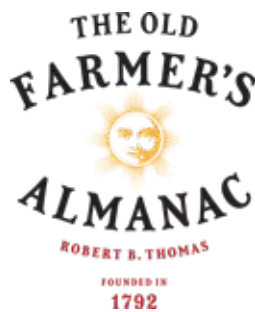

Old Farmer's Almanac

Counter Display. Recognized for generations by its familiar yellow cover, America's best-loved annual and oldest continuously published periodical promises to be "useful, with a pleasant degree of humor," once again fulfilling both the mission set forth by its founder, Robert B. Thomas, and readers' expectations. This edition is packed with wit, wisdom, tips, advice, facts, fun, recipes, and much more.

Item #	Desc	UPC	Vendor	CS/UOS	Location
80460001	2025	014021032339	1024	24/24	East



Old Farmer's Almanac Gardening Calendar

A perennial favorite of gardeners for years, this beautiful calendar offers original full-color illustrations, timely gardening advice, fun facts, quotes, and lore. The 2025 Gardening Calendar offers friendly reminders on when to start perusing seed catalogs or planting summer-flowering bulbs, inspiring quotations from poets and public figures, growing advice on favorite plants like forsythia and rhubarb, tips on getting rid of pests, and folklore for predicting how the weather will affect your garden. All packed into a stunning wall calendar!

Item #	Desc	UPC	Vendor	CS/UOS	Location
80460015	Calendar	14021032360	2020	20/20	East



Replacement Pole Aluminum

Easy to use 5-foot replacement aluminum pole for use with flags or banners. 1in diameter.



Item #	Desc	UPC	Vendor	CS/UOS	Location
80400377	5' Pole only	085199002141	25110	1/1	East

Replacement Flag 3' x 5' Poly/Cotton



Item #	Desc	UPC	Vendor	CS/UOS	Location
80400356	3'x5'	085199254045	25404	6/6	National

USA Polycotton Flag Dowel



Item #	Desc	UPC	Vendor	CS/UOS	Location
80400364	4"x6" ball tip	085199654319	25431F	144/144	National
80400365	8"x12" spear tip	085199654326	25432F	144/144	National
80400366	12"x18" spear tip	085199654333	25433F	144/144	National

Flags Stick Display

The Heath Outdoor Products - made in USA flags - #25154 combination pack. Includes 120 each 12-inch by 18-inch (#25433) staff flags and 108 each 4-inch by 6-inch 4-pack (#25434). Show your patriotism with pride. Cotton staff flags are perfect for parades, promotions or decorations. They feature a non-fray finish and are mounted on wooden staffs with flattened safety tips.



Item #	Desc	UPC	Vendor	CS/UOS	Location
80400381	Flag Display	10085199451564	25154-SW	1/1	National



Fence And Deck Hook

Great for hanging a bird feeder near a window made of durable black powder coated steel also perfect for hanging your favorite plant, bird feeder, or yard ornament. Hand-crafted forged curl brings Old World style to your backyard. When hung securely with screw in mount securely this hook will hold up to 15 lb.

Item #	Desc	UPC	Vendor	CS/UOS	Location
80630049	36"	727332060365	27480	6/6	National

Wrought Iron Shepherd Hooks

Single. Solid Square Steel. Item comes in black powder coat finish. Hand made heavy duty wrought iron.

Item #	Desc	UPC	Vendor	CS/UOS	Location
80630051	48"	727332624086	27500	12/12	National
80630052	70"	727332000613	27501	6/6	National

Shepherd Hooks

Hook crane used to hold feeders and plants. Hand-crafted wrought iron construction.

Item #	Desc	UPC	Vendor	CS/UOS	Location
80630056	81" Single	727332200082	27505	6/6	National
80630053	90" Single	727332000620	27502	6/6	National

Curved Deck Rail Hook

Comes with a clamp for 2x4 or 2x6 Rail. Item comes in black powder coat finish. Hand made heavy duty wrought iron.

Item #	Desc	UPC	Vendor	CS/UOS	Location
80630050	36"	727332208101	27481	6/6	National

Upturn Angled Hanger

Comes in black powder coat finish. Hand made wrought iron.

Item #	Desc	UPC	Vendor	CS/UOS	Location
80630008	6"	727332116062	27407	12/12	National
80630007	12"	727332120120	27406	12/12	National



Single Promo Shepherd Rod

Crane is 60" in height and a 1/2" solid round steel poll with one hook. Comes in black powder coat finish



Item #	Desc	UPC	Vendor	CS/UOS	Location
80630068	60"	727332608086	27532	6/6	National

Double Wrought Iron Shepherd Rod

81" Double Wrought Iron Shepherd rod with solid square knock down base.



Item #	Desc	UPC	Vendor	CS/UOS	Location
80630057	81"	727332204080	27506	6/6	National

Double Promo Shepherd Rod

Crane is 90" in height and with a 1/2" solid round steel with 2 hooks. Comes in a black powder coat finish.



Item #	Desc	UPC	Vendor	CS/UOS	Location
80630071	84"	727332620101	27535	6/6	National

Downturn Straight Hanger

Comes in black powder coat finish. Hand made wrought iron.



Item #	Desc	UPC	Vendor	CS/UOS	Location
80630012	10"	727332136107	27411	12/12	National
80630011	12"	727332140128	27410	12/12	National

Upturn Straight Hanger

Comes in black powder coat finish. Hand made wrought iron.



Item #	Desc	UPC	Vendor	CS/UOS	Location
80630010	6"	727332124067	27409	12/12	National
80630009	15"	727332128157	27408	12/12	National

Upturn Curved Hanger

Comes in black powder coat finish. Hand made wrought iron.



Item #	Desc	UPC	Vendor	CS/UOS	Location
80630006	6"	727332100061	27405	12/12	National
80630005	9"	727332104090	27404	12/12	National
80630004	12"	727332108128	27403	12/12	National
80630003	18"	727332112187	27402	12/12	National
80630002	24"	727332113115	27401	6/6	National

Downturn Curved Hanger W/ Forged Curl

Black powder coated steel attaches to wood fences or decks. Long 48" hook allows you to hang your plant from the deck at just the right angle. When attached securely to a railing this hanger will hold up to 10 lb.



Item #	Desc	UPC	Vendor	CS/UOS	Location
80630013	16"	727332176912	27412	12/12	National

Plant Pot Ring

Hang potted plants where you want them with a plant pot ring. Multiple sizes available for varying container sizes in a black powder coat finish



Item #	Desc	UPC	Vendor	CS/UOS	Location
80630033	4"	727332300041	27460	12/12	National
80630034	6"	727332308061	27461	12/12	National
80630035	8"	727332312082	27462	12/12	National
80630036	10"	727332316103	27463	12/12	National

S Hooks

Items made with black powder coat finish. Hand made heavy wrought iron.



Item #	Desc	UPC	Vendor	CS/UOS	Location
80630025	4" x 1"	727332183118	27437	12/12	National
80630024	6" x 1"	727332183125	27436	12/12	National
80630026	6" x 2"	727332168061	27438	12/12	National
80630023	8" x 1"	727332183132	27435	12/12	National
80630027	12" x 2"	727332172129	27439	12/12	National
80630028	18" x 2"	727332176189	27440	12/12	National
80630029	24" x 2"	727332180247	27441	12/12	National



Downturn Curved Hanger

Heat-treated steel with a black matte finish. Useful for hanging plants or feeders.



Item #	Desc	UPC	Vendor	CS/UOS	Location
80630014	8"	727332176912	27413	12/12	National

Adjustable Deck Hanger w/ Clamp for Rail

Great for hanging a bird feeder near a window. Made of durable black powder coated steel. Also perfect for hanging your favorite plant, birdfeeder, or yard ornament. Hand-crafted forged curl brings Old World style to your backyard. When hung securely this hook will hold up to 15 Lbs.



2025

Item #	Desc	UPC	Vendor	CS/UOS	Location
80630048	36"	727332183538	27479	6/6	National

J Hook With Flared End

Made of durable black powder coated steel; perfect for hanging your favorite plant, bird feeder, or decoration. Versatile hanger works in almost any indoor or outdoor setting. When hung securely this hook will hold up to 25 lb.



Item #	Desc	UPC	Vendor	CS/UOS	Location
80630037	3"	727332152039	27445	12/12	National



Mask w/Ear Loop Nonwoven Cloth



Item #	Desc	UPC	Vendor	CS/UOS	Location
81311763	3-ply 20pk	869292900135	MSK	1/1	East



Spiral Metal Rain Gauge

Rapitest Rain Gauges are made to accurately record rain fall while decoratively accenting the yard, patio or garden. All of our cylinders are polystyrene to resist the effects of weather and resist breaking if dropped. All of our cylinders are also properly scaled up to 5" (12.5cm) using both imperial and metric measurements.



Item #	Desc	UPC	Vendor	CS/UOS	Location
80140173	Rain Gauge Spiral	035307016461	1646	6/6	National

Rapitest® Rain Gauge in Deco Holder

An attractive rain gauge for your container or garden bed. It will accurately measure the amount of moisture your garden or any outdoor area is receiving. The Rapitest Rainfall Gauge is scaled in both millimeters and inches. Includes adjustable mounting stake. Adjustable in height. Easy to assemble. Height: 39.5" Material: Vinyl coated steel.



Item #	Desc	UPC	Vendor	CS/UOS	Location
80140064	Rain Gauge	003530716409	1640	6/6	National

SOURCING HAS NEVER BEEN THIS SIMPLE



One login connects you to the industry's broadest selection of products for growers and independent retailers!

PLACE YOUR ORDER TODAY AT WWW.GRIFFINS.COM

Decorative Garden Stake

The beautiful fairy butterfly graceful vintage pattern garden stake can decor your garden or lawn, adding color and life to your garden.



Item #	Desc	UPC	Vendor	CS/UOS	Location
80162160	Monarch Stake	093432285701	28570	12/12	National

Whimsical Plant Stand Tricycle

Whimsical tricycle plant stand with powder-coated finish. The generous platform and top support ring can accommodate pots up to 10 Inches in diameter. 24.5L x 12W x 17H in.



Item #	Desc	UPC	Vendor	CS/UOS	Location
80160333	Tricycle	093432891858	89185	2/2	East



Vintage Seed Pocket Buckets w/ Wood Handles

Assorted 2.5 quart aged galvanized buckets with handle displaying a vintage seed packet design.

Item #	Desc	UPC	Vendor	CS/UOS	Location
80161431	2.5 quart	093432832929	83292	12/12	West

Milkhouse Herbs Oval Planter



Item #	Desc	UPC	Vendor	CS/UOS	Location
80161684	16"	093432826225	82622	6/6	National

Antique Red Industrial Wagon Planter

Plant stand has sturdy base and unique, industrial metal look, moving wheels and sewn in coco liner.



Item #	Desc	UPC	Vendor	CS/UOS	Location
80161386	14"	093432866887	86688	2/2	East

16" Green Grower's Wall Planter

Wall planter mounts easily to fenceline, wall, or railing. Includes coco fiber liner.



Item #	Desc	UPC	Vendor	CS/UOS	Location
80160154	16"	093432885093	88509	12/12	East

Wire Easel Stand

This 30-inch metal easel is made of powder-coated steel. The legs of this easel are designed to easily be driven into soft ground for items to be at the gravesite. It flaunts a green shade that will blend well with your outdoor decor.



Item #	Desc	UPC	Vendor	CS/UOS	Location
80160888	30"	093432310052	31005	60/60	National



Large Fleur-De-Lis Double Hook

Large fleur-de-lis double hook shepherd staff. Made of 1/2" rod material. Powder coated glossy black finish.



Item #	Desc	UPC	Vendor	CS/UOS	Location
80160172	72"	093432887226	88722	4/4	National

Single Shepherd Hook

Made from a solid square tube steel, stronger than the round wire shepherd's hooks and powder coated after they are formed.



Item #	Desc	UPC	Vendor	CS/UOS	Location
80160055	48" Single	093432894385	89438	10/10	National

Black Shepherd's Hook

Made of round steel wire approximately 1/2" thick and powder coated after it is formed into shape.



Item #	Desc	UPC	Vendor	CS/UOS	Location
80160029	36" Single	093432890240	89024	12/12	National
80160034	48" Single	093432890349	89034	10/10	National
80160021	64" Single	093432890035	89003	10/10	National
80160032	84" Single	093432890318	89031	10/10	National

Curved Hanging Plant Hook

Home decor items are the best way to ensure that you can inject your personality into your home and make everything look like a reflection of who you are. Choose from an exciting range of products for home decor and add lovely silhouettes or textures to any room.



Item #	Desc	UPC	Vendor	CS/UOS	Location
80160048	7"	093432894071	89407	12/12	West
80160051	12"	093432894118	89411	12/12	West

Hanging Plant Bracket

The hardened steel construction creates a sturdy piece, and the black finish helps draw the eye to it.



Item #	Desc	UPC	Vendor	CS/UOS	Location
80160235	12"	093432855218	85521D	6/6	National

10" Swivel Bracket



Item #	Desc	UPC	Vendor	CS/UOS	Location
80160204	White	093432854020	85402	12/12	National

Deck Railing Flower Box Holder

Decorative flower box holder can mount easily over a deck rail or round fence. Powder coated steel for added durability.



Item #	Desc	UPC	Vendor	CS/UOS	Location
80160244	Black 2" x 6"	093432890431	89043	6/6	National
80160242	Green 2" X 6"	093432890080	89008	6/6	National

"J" Hook Double Black

Forged extension J hook. The top of this hook hangs on your standard branch, hook, or wall bracket, while the bottom, J shaped hanger holds your item. The heavy duty forged steel construction will last for several seasons, and the black color blends seamlessly with your preexisting decor. 8"

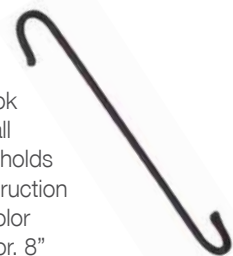

Item #	Desc	UPC	Vendor	CS/UOS	Location
80160049	Black	093432894095	89409	24/24	West

36" Extender Chain

3 pack

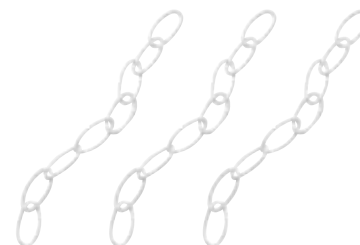

Item #	Desc	UPC	Vendor	CS/UOS	Location
80160208	White	093432864029	86402	6/6	National

Heart Shaped Folding Basket Hanger

An elegant heart shape design adds beauty to any outdoor area. Hanger will hold a 10" or 12" basket, which hangs from the unit to help keep the pot off the deck or patio.



Item #	Desc	UPC	Vendor	CS/UOS	Location
80160004	40"	093432881002	88100	6/6	National

Antique Gold Flower Bracket

Hanging plant bracket for indoor or outdoor use. Ideal for plants, bird feeders, wind chimes, and other hanging decor. Hanging hardware included for easy installation.



Item #	Desc	UPC	Vendor	CS/UOS	Location
80160233	9" Gold	093432856437	85643	6/6	National

Aluminum Deck Bracket

Adjustable Deck Mount Bracket allows you to place flower boxes in a new area. Powder-coated for added durability. 12" W x 3.375" H



Item #	Desc	UPC	Vendor	CS/UOS	Location
80160251	Adjustable	093432890578	89057	12/12	West

Aluminum Wall Bracket

Place flower boxes in a new area. Mount easily to a wall to hold your flower box. Powder-coated for added durability. 7" W x 4" H



Item #	Desc	UPC	Vendor	CS/UOS	Location
80160253	Adjustable	093432890592	89059	12/12	West

Forged Straight Black Hook

Made of solid round and square rod with a powder coated black finish for long life.



Item #	Desc	UPC	Vendor	CS/UOS	Location
80160047	6"	093432894064	89406	12/12	West
80160050	10"	093432894101	89410	12/12	West
80160053	15"	093432894156	89415	12/12	National

Angled Black Hook

Forged angled wall bracket. The flat side of this bracket mounts to a wall with the two included screws. The black color will meld with the surroundings, and the sturdy steel construction creates a lasting hook.



Item #	Desc	UPC	Vendor	CS/UOS	Location
80160052	12"	093432894125	89412	12/12	West

Extender S Hook



Item #	Desc	UPC	Vendor	CS/UOS	Location
80160212	Black 2-Pk	093432865019	86501	12/12	National
80160213	White 2Pk	093432865026	86502	12/12	National

Forged "S" Hook

Hang a small basket or planter with this forged S-shaped hook that will give your yard a touch of old world class.



Item #	Desc	UPC	Vendor	CS/UOS	Location
80160286	6"	093432857557	85755	12/12	West

Garden "S" Hook

Made of steel wire with a powder coated black finish.



Item #	Desc	UPC	Vendor	CS/UOS	Location
80160022	4" - 2 pk	093432890110	89011	12/12	National
80160023	6" - 2 pk	093432890127	89012	12/12	National
80160024	8" - 2 pk	093432890134	89013	12/12	National
80160026	18"	093432890158	89015	12/12	National
80160027	24"	093432890165	89016	12/12	National

PANACEA®

"J" Hooks

Available in black color. Made of solid round and square rod with a powder coated black finish for long life.



Item #	Desc	UPC	Vendor	CS/UOS	Location
80160044	3" w/Screw	093432894033	89403	24/24	National
80160045	6" Threaded	093432894040	89404	24/24	National

Ceiling Hook

Ceiling Decorative hook that can hold wind chimes, flowering baskets, tube feeders or lanterns. Makes your garden look more complete. Powder-coated for added durability.



Item #	Desc	UPC	Vendor	CS/UOS	Location
80160954	Black 5pc	093432862018	86201	12/12	National
80160955	White 5pc	093432862025	86202	12/12	National
80160956	Antique 5pc	093432862056	86205	12/12	National

Swag Hook



Item #	Desc	UPC	Vendor	CS/UOS	Location
80160885	Black 2 Pack	093432861011	86101	6/6	National
80160886	White 2 Pack	093432861028	86102	6/6	National

Wreath Hanger

Over-the-Door Wreath Hangers are designed as an easy way to hang your wreaths with ease. Each hanger fits over a door and then you hang your wreath on the hook.



Item #	Desc	UPC	Vendor	CS/UOS	Location
80161968	Black	093432362020	36202	12/12	National
80161969	White	093432362068	36206	12/12	National
80161970	Brass	093432362099	36209	12/12	National

Jumbo Ceiling Hook

Panacea's HoldAll® Jumbo ceiling hook features metal construction and a powder-coated finish.



Item #	Desc	UPC	Vendor	CS/UOS	Location
80160951	Black	093432861219	86121	6/6	National

Swivel Ceiling Hook

This small hook has a solid base, while the hook rotates 360°. This rotation allows you to see all facets of your hanging item, or allows your plants in hanging baskets to receive sunlight on all sides. The package includes a standard screw to mount the hook to a wooden ceiling or exposed beam, as well as a bolt and toggle nut for plaster or wallboard ceiling installations.



Item #	Desc	UPC	Vendor	CS/UOS	Location
80160205	Black 11/2"	093432861318	86131	6/6	National



Microfiber Cloth

Ultra Absorbent Microfiber Cleaning Cloths are perfect for cleaning delicate surfaces. These high-tech microfiber cloths grab hold of dirt, grease, dust and grime and locks onto them. Reuse over and over by simply throwing them into the laundry and washing them along with your clothes. Tumble dry on no heat.



Item #	Desc	UPC	Vendor	CS/UOS	Location
82660007	12"x16" 9 Pack	818762020453	SHX-MFW-9GD-B	1/1	National
82660006	16"x16" 30 Pack	813020019095	SHX-MFW30-B	1/1	National



All planters feature drain holes.

Colorful Frog & Gecko Wall Décor

18" wide metal frog and gecko wall decor. All pieces include a wall hanger.



Item #	Desc	UPC	Vendor	CS/UOS	Location
80731339	18"	727744402630	MCFG18	6/6	East



Colorful Garden Insects

Metal garden insects. 7.5" x 6" x 6"

Item #	Desc	UPC	Vendor	CS/UOS	Location
80731105	Garden Insects	727744280184	DSGI4	16/16	National

Brilliant Butterflies

19" Brilliant Butterflies.

Metal wall décor to put that finishing touch on your indoor or outdoor design. All pieces include a wall hanger.



Item #	Desc	UPC	Vendor	CS/UOS	Location
80731416	19" Assorted Colors	727744402760	MBRB19	6/6	National



Stainless Steel Globe

Our steel globes are unbreakable and weatherproof. Available in sizes from 2" up to 20" diameter. Colored in Michigan. Guaranteed not to chip, peel or fade. Creates a great accent for the garden or landscape with a splash of color and a mirrored reflection.

Item #	Desc	UPC	Vendor	CS/UOS	Location
80730750	10" Blue	727744050107	BLU10	1/1	East
80730819	10" Purple	727744030109	PRP10	1/1	East
80730735	10" Rainbow	727744080104	RNB10	1/1	East

Vibrant Dot Butterfly

20" metal butterfly wall decor. All pieces include a wall hanger.



Item #	Desc	UPC	Vendor	CS/UOS	Location
80731343	20"	727744402692	MVDB20	4/4	East

Vibrant Dot Dragonfly

20" metal dragonfly wall decor. All pieces include a wall hanger.



Item #	Desc	UPC	Vendor	CS/UOS	Location
80731344	20"	727744402708	MVDD20	4/4	East

Ladybugs

19" Metal ladybug wall decor. Four of each color; red, blue and yellow. All pieces include a wall hanger.



Item #	Desc	UPC	Vendor	CS/UOS	Location
80731279	19" Assorted Colors	727744402425	MRBYL19	12/12	East

Bold Butterflies

12" Bold Butterflies. Metal wall décor to put that finishing touch on your indoor or outdoor design. All pieces include a wall hanger.



Item #	Desc	UPC	Vendor	CS/UOS	Location
80731413	12" Assorted Colors	727744402715	MBB12	8/8	National

Ladybug & Bumblebee Wall Décor

12" wide metal ladybug and bumblebee wall decor. All pieces include a wall hanger.



Item #	Desc	UPC	Vendor	CS/UOS	Location
80731341	12"	727744402647	MLB12	8/8	East

Drippy Caterpillar

16" Drippy Caterpillar 9" x 8.5" x 16"



Item #	Desc	UPC	Vendor	CS/UOS	Location
80731349	16"	727744280351	DDCP16	2/2	National



All planters feature drain holes.



Garden Friends Wall Décor

11" Garden Friends. Metal wall décor to put that finishing touch on your indoor or outdoor design. All pieces include a wall hanger.

Item #	Desc	UPC	Vendor	CS/UOS	Location
80731422	11"	727744402791	MGDF11	10/10	East

Welcome Sign with Flower

42" Welcome Sign with Flower. Made in the USA. Wood wall décor to put that finishing touch on your indoor or outdoor design. All pieces include a wall hanger.



Item #	Desc	UPC	Vendor	CS/UOS	Location
80731430	42"	727744402753	MWSF42	4/4	East



Rain Gauge

Transparent rain gauge with dark green hanging ring. Measures the precipitation in mm and inches. Conveniently hangs on ground pin. In decorative packaging.



Item #	Desc	UPC	Vendor	CS/UOS	Location
81552757	Rain Gauge	702633106950	34-10695	3/3	National

Little Pals Bug Watching Activity Kit

Embark on a bug-watching journey! The kit contains a tool bag, a bug net, a bug viewer, plastic tweezers, a bug catcher, binoculars, and a comprehensive bug checklist with a pen.



Item #	Desc	UPC	Vendor	CS/UOS	Location
81552576	Activity Kit	813269018293	7-LP730	4/4	National



22" Decorated Pumpkin

Halloween decoration fun for inside or out. Can be used non-illuminated, or illuminated with cord. 22" x 15.5" x 15.5"

Item #	Desc	UPC	Vendor	CS/UOS	Location
81320067	Cord/light included	78304558411	55841	1/1	East

Zombie Flamingos

With this Zombie flamingo pair standing guard, maybe the real Zombies won't bother you - they'll think their cohorts have beat them to the punch. One of these frightening birds is standing while the other is feeding; both are on high alert. 12.2 x 4 x 18.5 inches.



Item #	Desc	UPC	Vendor	CS/UOS	Location
81320073	Zombie Flamingos	078304623638	62363	4/4	East

Pink Flamingos

Includes 1 each 29" standing & 19" feeding, made from sturdy salmon pink weather resistant plastic and metal legs. Each flamingo includes Don Featherstones signature. Comes in a colorful tropical retail display box.



Item #	Desc	UPC	Vendor	CS/UOS	Location
81320002	Pink Flamingos	078304623607	62360	4/4	East

Union Featherstone Realmingo

52" original Featherstone feeding flamingo statue. Body is weather & fade-resistant plastic and the leg is painted weather resistant wood.



Item #	Desc	UPC	Vendor	CS/UOS	Location
81320003	Garden Flamingo	078304625656	62565	1/1	East



Sparrow

Spandex back made with WasteNot™ yarn is comprised of 96% recycled PET bottles, microfibre palm and silicone printed palm. Features hooded fingertips and knuckle bar, snug fitting shirred elastic wrist with slip-on style cuff.



Item #	Desc	UPC	Vendor	CS/UOS	Location
82290010	Small	065537866109	204-S	6/6	East
82290009	Medium	065537866116	204-M	6/6	East
82290008	Large	065537866123	204-L	6/6	East

Uptown Girl

Spandex back made with WasteNot™ yarn is comprised of 96% recycled PET bottles, hooded fingertips and padded knuckle bar, wavy polyurethane coated palm for a sure-grip conductive thumb and fingertips can be used on touchscreen devices. Snug fitting shirred elastic wrist with slip on style cuff.



Item #	Desc	UPC	Vendor	CS/UOS	Location
82290064	Small	065537824055	111-S	6/6	East
82290063	Medium	065537824062	111-M	6/6	East
82290062	Large	065537824079	111-L	6/6	East

Women's Game of Thorns

Hard-wearing microfibre palm, padded palm patch, Spandex back made with WasteNot™ yarn is comprised of 96% recycled PET bottles, reinforced hooded fingertips, knuckle bar and thumb saddle, microfibre laminated PVC gauntlet style cuff.



Item #	Desc	UPC	Vendor	CS/UOS	Location
82290074	Medium	065537832661	307-M	6/6	East
82290073	Large	065537832678	307-L	6/6	East

Men's Game of Thorns

Billions of plastic bottles go into landfills every year. But now you can do something about it. Our WasteNot™ yarn is made from 100% recycled PET bottles. PET stands for polyethylene terephthalate which is a form of polyester. Plastic bottles made from PET are recycled and turned into polyester to make gloves.



Item #	Desc	UPC	Vendor	CS/UOS	Location
82290056	One Size	065537836430	314	6/6	East

Rosé

A customer favorite! WasteNot™ polyester seamless knit gloves are made from 30% recycled post consumer PET bottles. These lightweight gloves have a sandy latex coating engineered with Reclaim™ additive that accelerates biodegradation in landfill conditions (ASTM DSSII), treated to bead water off which lasts up to 5 washes, snug-fitting seamless knit wrist.



Item #	Desc	UPC	Vendor	CS/UOS	Location
82290103	Small	065537905709	376-S	6/6	East
82290102	Medium	065537905723	376-M	6/6	East
82290101	Large	065537905716	376-L	6/6	East

Karma

WasteNot™ polyester seamless knit gloves are made from 25% recycled post consumer PET bottles. These lightweight gloves are engineered with a foam nitrile palm engineered with Reclaim™ additive that accelerates biodegradation in landfill conditions. (ASTM DSSII)



Item #	Desc	UPC	Vendor	CS/UOS	Location
82290035	Small	065537866178	375-S	6/6	East
82290034	Medium	065537866185	375-M	6/6	East
82290033	Large	065537866161	375-L	6/6	East

Lite as a Feather

WasteNot™ polyester seamless knit gloves made from 50% recycled post consumer PET bottles. These lightweight polyurethane gloves are engineered with a Reclaim™ additive that accelerates biodegradation in landfill conditions (ASTM DSSII), snug-fitting seamless knit wrist.



Item #	Desc	UPC	Vendor	CS/UOS	Location
82290077	Small	065537858845	317-S	6/6	East
82290076	Medium	065537858852	317-M	6/6	East
82290075	Large	065537858869	317-L	6/6	East

L'il Buggers

100% cotton. Snug-fitting knit wrist.



Item #	Desc	UPC	Vendor	CS/UOS	Location
82290059	XX-Small	065537071466	6165	12/12	East



Oh, Snap! (Kids)

15gg WasteNot™ polyester knit made from 23.5% (+/- 2%) recycled post consumer PET bottles. Sandy latex palm coating. Ergonomically formed. Snug-fitting seamless knit wrist.



Item #	Desc	UPC	Vendor	CS/UOS	Location
82290042	XX-Small	065537866277	6171-XXS	6/6	East
82290041	X-Small	065537866284	6171-XS	6/6	East

L'il Sprout (Kids)

These Watson Gloves Homegrown XXS Polyester Knit L'il Sprout Green Gardening Gloves are perfect for all your little green fingers. They are lightweight and comfortable, and the snug fit makes them easy to wear while tending your garden. These gloves are made of high quality material, which makes them durable and long-lasting. They will be the perfect companion for your little one's gardening adventures.



Item #	Desc	UPC	Vendor	CS/UOS	Location
82290127	XX-Small	065537866253	6170-XXS	6/6	East

Splish & Splash (Kids)

Splish & Splash Gloves are the perfect size for your children! At a very small Kids Size XXS these nylon seamless knit gloves have a rubber crinkle latex coating to keep your kids hands safe while they play in the yard with mom and dad. These gloves have a snug fit wrist cuff to prevent dirt and grime from getting into the glove keeping your hands clean.



Item #	Desc	UPC	Vendor	CS/UOS	Location
82290058	X-Small	065537829197	6163	6/6	East

Baby Baa Baa Mitt

These Watson Gloves XXS Polyester Baby Baa Baa Mitt Cream Cold Weather Gloves are the perfect addition to your baby's winter wardrobe. They are made of ultra-soft polyester for maximum comfort and warmth. Designed to fit snugly around your baby's hands, they are ideal for keeping your little one's hands warm and safe in cold weather. Their vibrant cream color is sure to add a touch of style to any winter outfit.



Item #	Desc	UPC	Vendor	CS/UOS	Location
82290052	XXSMALL	065537904504	9383-XXS	6/6	East

EMAIL PROGRAMS *Connect with us!*

We offer several topical e-mail programs for growers and retailers. Tailor your subscriptions to meet your unique needs and interests, from technical tips to product specials and much more.

Visit www.griffins.com to subscribe!



Sweet Pea



Pear

Amethyst

MUD Women's Nylon w/ Flexible Nitrile Palm

Item #	Desc	UPC	Vendor	CS/UOS	Location
81751212	Amethyst-XS	662909515544	MD31031A-WXS	3/3	East
81751216	Pear-XS	662909515582	MD31031P-WXS	3/3	East
81751220	Sweet Pea-XS	662909515629	MD31031SP-WXS	3/3	East
81751213	Amethyst-S	662909515551	MD31031A-WS	3/3	East
81751217	Pear-S	662909515599	MD31031P-WS	3/3	East
81751221	Sweet Pea-S	662909515636	MD31031SP-WS	3/3	East
81751214	Amethyst-M	662909515568	MD31031A-WM	3/3	East
81751222	Sweet Pea-M	662909515643	MD31031SP-WM	3/3	East
81751219	Pear-L	662909515612	MD31031P-WL	3/3	East



Ladies Mud Glove Nitrile Palm w/ Daisy Print

These daisy print gloves are lightweight, and feature a flat nitrile-coated palm.



Item #	Desc	UPC	Vendor	CS/UOS	Location
81751141	XS/S	662909514295	MD31001B-WXS	3/3	East
81751142	S/M	662909514301	MD31001B-WSM	3/3	East
81751143	M/L	662909514318	MD31001B-WML	3/3	East

HI-VIZ Lime Green Mesh Safety vest

One Size



Item #	Desc	UPC	Vendor	CS/UOS	Location
81751252	Safety Vest	662909000000	SW46202-0	1/1	East

Jersey Work Gloves Brown

Jersey work gloves are a comfortable and breathable fit. Ideal for light tasks, stretch back for flexibility, knit wrist to keep out dirt and debris. *6/pairs in per bag



Item #	Desc	UPC	Vendor	CS/UOS	Location
81750370	Large	072874004231	4020	1/1	East
81750373	3 pc Bag	072874402303	4023	1/1	East

Boss® Jobmaster® Nylon Nitrile Coated Glove

Maximum dexterity and tactility. Nylon with nitrile coated palm. Resistance to abrasions & cuts. Open, breathable back. Flexible knit wrist seals out dirt & debris.



Item #	Desc	UPC	Vendor	CS/UOS	Location
81750514	Medium	072874069483	8442M	12/12	East
81750515	Large	072874069490	8442L	12/12	East
81750516	X-Large	072874069506	8442X	12/12	East



Hanging Solar Jar

The Solar Hanging Jar is perfect for entertaining and outdoor dining. Suitable for hanging or freestanding. Made of glass with a rope handle. Fully-charged AAA battery included for its LED light.



Item #	Desc	UPC	Vendor	CS/UOS	Location
81730488	Solar Jar	814567026850	6730	9/9	East

Light Motion Sensor Stainless Steel Bollard

Motion sensor bollard light perfect for illuminating pathways. Standby mode is 5 lumens. Increases to 50 lumens when motion sensor is activated.



Item #	Desc	UPC	Vendor	CS/UOS	Location
81730481	Solar Light	814567025280	6762	12/12	East

Westland



Birdbaths

Two sizes to choose from! (12 birdbaths to a pallet). Features a locking top. 4 of each color - Cobalt Blue, White, and Dark Green

Item #	Desc	Vendor	CS/UOS	Location
82720006	15" x 19"	VMB02- S	12/12	National
82720005	19" x 23"	VMB02	12/12	National



GriffinExpo

SAVE THE DATE!

In-Person Expos

Expo West

August 27-28, 2025

Grand Sierra Resort Reno, NV

Expo East

September 4, 2025

Lancaster Marriott At Penn Square, Lancaster, PA



LAWN & GARDEN PROBLEM SOLVERS



CHECK OUT OUR
CLEARANCE ITEMS!



Griffin Greenhouse Retail WAREHOUSE Shipping Map

We are now shipping nationwide!

NATIONAL



2025

Refer to location key:

National items are stocked nationally
 Select items are sold East or West only; no exceptions

8" Kaleidoscope Planter

Premium plastic modular planter can be displayed individually each planter has a removable saucer ideal for succulents or shallow rooted planted.

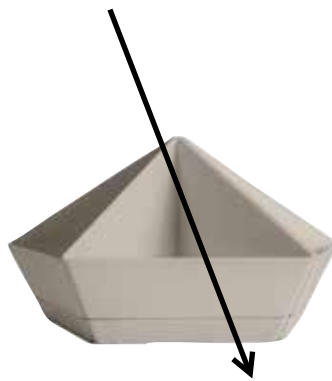

Item #	Desc	UPC	Vendor	CS/UOS	Location
80282643	Vanilla Bisque	770932844170	KDP08000A58	6/6	National

Where is the pricing?

1. Scan QR code on Chapter Pages to see pricing on Griffins.com
2. Contact your Griffin Sales Representative
3. Call into Griffin Customer Service 800.888.0054



ARBER



Bio Fungicide

Control challenging diseases longer with our natural bio fungicide. Protects against fungus, mold, mildew, and rot using Mother Nature's good bacteria. Say goodbye to disease on your leaves and in your soil and hello to stronger plants.

Item #	Desc	UPC	Vendor	CS/UOS	Location
82200006	8 oz Con.	850025915199	1-331762-2	6/6	East
82200002	16 oz Con.	850025915007	1-331712-1	6/6	East

Bio Insecticide

Prevent insect and mite build up and suppress soil-dwelling pests with our Bio Insecticide. This unique formulation uses good bacteria that's harmless to beneficial insects and pollinators and helps your plant thrive. Grow plants, not pests with over 20 natural compounds that are effective against the smallest yet mightiest of pests.

Item #	Desc	UPC	Vendor	CS/UOS	Location
82200008	8 oz Con.	850025915205	1-341762-2	6/6	East
82200003	16 oz Con.	850025915014	1-341712-1	6/6	East

Bio Protectant

Our Bio Protectant acts to increase your plants' chlorophyll production to keep them greener longer while also boosting your plants' immune system to ensure your plants remain healthy.

Item #	Desc	UPC	Vendor	CS/UOS	Location
82200007	8 oz Con.	850025915182	1-521762-2	6/6	East
82200001	16 oz Con.	850025915038	1-521712-1	6/6	East

Spray Bottle

Ensure your gardens get their required hydration and nutrients with our Spray Bottle. Featuring a spray nozzle and a translucent design, the Spray Bottle holds up to 32oz making mixing up our concentrates simple and adding convenience to your regular plant wellness routine.



Item #	Desc	UPC	Vendor	CS/UOS	Location
82200005	32oz.	850025915045	3-764926-1	8/8	East

Atlas Chemical Corp.

Super Gasser

Atlas Giant Destroyers is designed to permanently get rid of pesky burrowing animals, such as gophers, groundhogs, moles, and ground squirrels from your yard. Insert a giant destroyer cartridge into the tunnel and cover all the exits. Then light the Giant Destroyer to release gas into the tunnels. The gas will instantly kill underground pests. **Not for sale in HI**

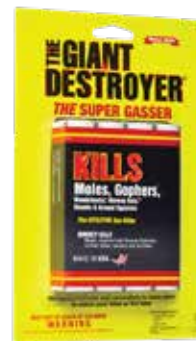

Item #	Desc	UPC	Vendor	CS/UOS	Location
82520001	Super Gasser	010052003331	00333	12/12	National

BONIDE® HERBICIDES

Weed Beater® Plus Crabgrass & Broadleaf

Contact and systemic action. Kills grassy and broadleaf weeds like crabgrass, clover, chickweed, oxalis, dollarweed, spurge, foxtail and over 200 others. Not recommended for St. Augustine or Centipede grass type turf. Combines Quinclorac, 2,4-D and Dicamba for complete post emergent weed control, right down to the roots!

Not for sale in AK, HI, NY, SC, UT, PR



Item #	Desc	UPC	Vendor	CS/UOS	Location
80100048	32 oz. RTU	037321000655	065	12/12	National
80100259	32 oz. RTS	037321000662	066	12/12	National

Kleen Up HE Concentrate

Bonide KleenUP he Concentrate is a highly efficient, fast-acting, nonselective herbicide designed to kill over 200 types of weeds, brush, and grasses in one application. Starts working upon contact and kills down to the root so weeds won't grow back. This product is rainfast in just hours after application so it won't be washed away.



Item #	Desc	UPC	Vendor	CS/UOS	Location
80101015	1 pt Not For Sale in ME, NY	037321007524	752	6/6	East
80101016	1 qt Not For Sale in NY	037321007531	753	6/6	National
80101017	1 gal Not For Sale in NY	037321007548	754	4/4	National



KleenUp® HE RTU

Kills all unwanted weeds and grasses. Great for preparing flowerbeds, vegetable and ornamental garden sites, renovating lawns and for multipurpose weed control. Complete, to the root control in 2-4 weeks. Visible results in hours.



Item #	Desc	UPC	Vendor	CS/UOS	Location
80101018	32 oz. Not For Sale in NY	037321007579	757	6/6	National
80101019	1 gal.	037321007586	758	4/4	National

Captain Jack Lawnweed Brew

Derived from Iron, Captain Jack's Lawnweed Brew offers selective control of weeds, disease, moss, algae, and lichens in lawns. The active ingredient is derived from iron, which occurs in nature. Kills many common weeds like dandelion, clover, moss, narrow-leaved plantain, chickweed, and thistle. Works quickly, as dying weeds will be seen within hours of application.



Item #	Desc	UPC	Vendor	CS/UOS	Location
80101055	RTU 32oz Not For Sale in AL, AK, AR, AZ	037321026105	2610	6/6	National
80101056	RTU 32oz Not For Sale in PR	037321261025	26102	6/6	West
80101058	RTS 32oz Not For Sale in PR	037321026129	2612	6/6	National
80101057	Conc. 32oz	037321026112	2611	6/6	National
80101061	RTU 128oz Not For Sale in CA, HI, IA, KS, NE, PR, RI, SD	037321026167	2616	4/4	East

Captain Jack Deadweed Brew

Our herbicide provides fast-acting control of weeds, grass, mosses, & algae within hours. Captain Jack's Deadweed Brew is great for use on visible weeds within vegetable & flower gardens, landscaped areas, & lawns. It can also be used on visible weeds around & on buildings, sidewalks, fences, bark mulch, driveways, patios, & gravel. Approved and suitable for all of your organic gardening needs.



Item #	Desc	UPC	Vendor	CS/UOS	Location
80101050	RTU 32oz	037321026020	2602	6/6	National
80101049	Conc. 32oz	037321026013	2601	6/6	National
80101052	128oz Con.	037321026037	2603	4/4	East
80101053	128oz RTU	037321026044	2604	3/3	National

Brush Killer Bk-32

This powerful, non-volatile formulation works on the toughest weed species, yet is harmless to grass. It stays where you spray, without the danger of vapor damage or root uptake by surrounding trees and ornamentals. **Not for sale in AK, HI**



Item #	Desc	UPC	Vendor	CS/UOS	Location
80100066	16 oz. Con.	037321003304	330	12/12	National
80100166	32 oz. Con.	037321003311	3316	6/6	National

Chickweed, Clover & Oxalis Killer

Contains Horsepower® (Triclopyr + MCPA + Dicamba) Systemic action kills to the root. Compare and save. One pint treats 5,000 sq. ft., over 1½ times the competition. Plus, the label lists over 150 additional tough to control weeds. **Not for sale in AK, HI, OK**



Item #	Desc	UPC	Vendor	CS/UOS	Location
80100202	16 oz. Con.	037321000617	061	12/12	National

Sedge Ender

Incredibly effective pre and post emergent control of goosegrass, nutgrass (and all sedges), crabgrass, foxtail and many, many other problem grassy type weeds. Safe to use on both northern and southern lawns. Excellent cool weather performance. Sulfentrazone plus Prodiamine. 16 oz. treats 2,000-8,700 sq. ft. **Not for sale in AZ, CA, LA, NY, ND, DC**



Item #	Desc	UPC	Vendor	CS/UOS	Location
80100004	16 oz. Con.	037321000693	069	12/12	East

Weed Beater® ULTRA

The ultimate systemic broadleaf weed killer for lawn and turf. New chemistry that's especially effective on over 200 hard-to-kill weeds, right to the roots. Visible results in just 24 hours! Rainfast once dry. Reseed in just two weeks. Superior cool-weather performance down to 45°F extends application window to early spring and late fall, when weeds are most susceptible. Non 2, 4-D formula contains MCPA, Mecoprop-p, Dicamba and Carfentrazone. 16 oz. concentrate treats up to 21,000 sq. ft. in the South and 10,000 sq. ft. in the North. Ready to use formula contains "See Spray" non-staining blue marker dye.



Item #	Desc	UPC	Vendor	CS/UOS	Location
80100065	16 oz. Con. Not For Sale in AK, PR, VT	037321003090	309	6/6	National
80100023	16 oz. RTS	037321003120	312	12/12	East
80100022	32 oz. RTU Not For Sale in AK, PR, HI	037321003076	307	12/12	National



CJ NeemMax RTU

4-In-1 Insecticide, Fungicide, Miticide & Nematicide. Cold pressed Neem Oil processed without chemicals. For residential use on listed crops including vegetables, fruits, citrus, nuts ornamental plants, lawns and other listed plants.



Item #	Desc	UPC	Vendor	CS/UOS	Location
80101100	0.5 gal Not For Sale in PR, SD	037321020066	2006	6/6	National
80101134	1 gal	037321020080	2008	3/3	National

CJ Fruit Tree Spray

Concentrated formula is an excellent product for the home orchardist. Controls both insects, and diseases on fruit trees, flowers, evergreens, and strawberries. Only need as little as 1-1/2 tablespoons per gallon. Ideal for fungus and insect control.



Item #	Desc	UPC	Vendor	CS/UOS	Location
80101101	Conc Pint Not For Sale in PR, SD, VT	037321020028	2002	6/6	National
80101102	Conc Quart	037321020035	2003	6/6	National

Weed-N-Feed

Popular product for care of grass and ornamental turf. No mixing. On/off switch for easy use. One quart treats 2,500 square feet. It contains 20-0-0 fertilizer plus 2,4-D and 2,4-DP. This product arrives in a container with an attached hose-end sprayer. Simply connect a garden hose to the sprayer and begin application. **Not for sale in FL, HI, PR**



Item #	Desc	UPC	Vendor	CS/UOS	Location
80100361	RTS 1 32oz	037321003014	301	12/12	National

Wilt Stop

Popular product for care of grass and ornamental turf. No mixing. On/off switch for easy use. One quart treats 2,500 square feet. It contains 20-0-0 fertilizer plus 2,4-D and 2,4-DP. This product arrives in a container with an attached hose-end sprayer. Simply connect a garden hose to the sprayer and begin application.



Item #	Desc	UPC	Vendor	CS/UOS	Location
80100205	40oz. RTU	037321000990	99	12/12	West

COMBOS

Pruning Sealer Aerosol

A superior protective seal for pruned, grafted or damaged trees, roses or shrubs. Contains an antiseptic and a sealant to kill and keep out infections and insects. Won't burn or run. Also can be used to waterproof planting pots, wooden tubs, canvas. Brown to blend with tree bark.



Item #	Desc	UPC	Vendor	CS/UOS	Location
80100013	14 oz.	037321002215	221	12/12	National

Citrus Fruit & Nut Orchard Spray

This all natural, all in one, insect and disease control concentrate is perfect for those customers that prefer a natural choice. Great for citrus, fruit and nuts, and also vegetables, ornamentals, houseplants and lawns. Truly effective and all purpose. Use as little as 2 1/2 oz./gal. Available in convenient, no-mix ready-to-spray bottles for easy application to trees and larger areas.



Item #	Desc	UPC	Vendor	CS/UOS	Location
80100160	32oz RTS	037321002161	216	12/12	National
80101041	32oz Con. Not For Sale in DC	037321002185	2186	6/6	National

Fruit Tree & Plant Guard

This goof proof water based combination is economical, versatile and has a very broad spectrum. Only 2 oz./gal. treats not only a comprehensive listing of fruit, but also nuts, flowers, shrubs and ornamentals. Available in concentrate, including our "Twist and Shoot" RTS for convenient tall tree spraying. Contains actives: Lambda Cyhalothrin, Pyraclostrobin, and Boscalid. **Not for sale in PR**



Item #	Desc	UPC	Vendor	CS/UOS	Location
80100679	16 oz. Con.	037321020219	2021	6/6	East
80100683	16 oz. RTS	037321020615	2061	12/12	East

Fruit Tree and Plant Guard Concentrate

Fruit Tree and Plant Guard is an easy, versatile and effective way to control and prevent listed insects and disease on fruit, nuts, ornamental trees, shrubs & flowers. Perfect for the novice or master orchardist. Protect Apples, Cherries, Peaches, Pears and more. Controls Powdery Mildew, Apple Scab, Fly Speck and more. **Not for sale in PR**



Item #	Desc	UPC	Vendor	CS/UOS	Location
80100680	1 qt Conc	037321020318	2031	6/6	East



Rose Rx 3 in 1 Concentrate

Rose Rx (4-in-1), insecticide, fungicide, miticide for organic gardening. Controls plant disease, mites and all stages of insect life cycles. Use on roses, flowers and more. **Not for sale in ID, ND, OK, PR, DC**



Item #	Desc	UPC	Vendor	CS/UOS	Location
80101135	16 oz Con. Not For Sale in DC, ND, OK	037321009177	817	6/6	East
80101089	32 oz RTU	037321008972	8976	6/6	East

Rose Shield Systemic Rose & Flower Drench

Bonide Rose Shield is very protective and will shield your roses from insects and disease for six weeks. This product can also be used on full flowerbeds as well as azaleas, camellias, and other shrubs. This product will protect your flowers from Japanese beetles, borers, aphids, black spot, powdery mildew, rust, and much more. **Not for sale in CA, CO, CT, LA, ME, MD, MA, NV, NJ, NY, RI, VT**



Item #	Desc	UPC	Vendor	CS/UOS	Location
80101025	40oz.	037321009474	947	6/6	West

Rose Shield

Lambda-Cyhalothrin kills bugs on contact and by ingestion. Thiamethoxam is absorbed by the plant, and moves rapidly throughout, killing insects from within. Difenconazole, a contact & systemic fungicide, works from within the plant as well, stopping existing, and preventing new plant disease. A great solution for insect and disease problems for roses, flowers, landscape plants, trees, shrubs and ground covers. Lasts up to 30 days. Rain proof within 60 minutes. **Not for sale in CA, CO, CT, LA, ME, MD, MA, NV, NJ, NY, PR, RI, VT**



Item #	Desc	UPC	Vendor	CS/UOS	Location
80100706	32 oz. RTU	037321009825	982	12/12	National

Rose Shield Insect & Feed

Systemic insecticide plus fertilizer for roses, flowers, and shrubs. Granular formula promotes strong roots and blooms while protecting plants against insect damage for up to 8 weeks. (1) 6 lb container treats up to 48 rose bushes or 300 square feet. Works to the roots and protects from the inside. This product kills Adelgids, Aphids, Fungus gnats and many more listed insects. **Not for sale in CA, ME, MD, MA, NJ, NY, RI, SD, VT**



Item #	Desc	UPC	Vendor	CS/UOS	Location
80101023	6lb. Granular	037321009467	946	4/4	East

INSECTICIDES

Revenge Wasp & Hornet

Provides instant knockdown, quick kill, and residual action that takes out the entire nest and prevents re-nesting. Jet spray shoots 20 feet. Works on yellow jackets, wasps, carpenter bees, and hornets. **Foam not for sale in AZ, ID, ME, NJ Aerosol not available for sale in AZ, CA, NJ, OR, RI**



Item #	Desc	UPC	Vendor	CS/UOS	Location
80101123	Foam 15oz. Not For Sale in ME, PR	037321046431	4643	12/12	National
80101122	Aerosol 15oz. Not For Sale in CA, NJ, OR, PR, RI	037321046530	4653	12/12	West

Mosquito Beater Plunks

Water soluble pouches provide the perfect delivery system for this natural mosquito larvicide. Upon dissolving, thousands of floating granules quickly and evenly release the Bti active ingredient across the surface of any standing water. **Not for sale in WA, DC**



Item #	Desc	UPC	Vendor	CS/UOS	Location
80100073	2 oz. / 24pk	037321005490	549	12/12	National

Revenge Ant Bait Stations

Pre-filled liquid ant bait stations for control of sweet, grease, Argentine and Carpenter Ants. Also kills roaches. Large 0.75 oz. bait stations with 1% low-dose formula for best control of large/multiple colony problems. Indoor/Outdoor use.



Not for sale in AK, DC, HI

Item #	Desc	UPC	Vendor	CS/UOS	Location
80100168	3 Pk.	037321451006	45100	12/12	National

Ant, Flea & Tick Granules

0.25% Permethrin. Fast acting, long lasting (4 weeks) insect control for lawns and home foundations. Great for ants, fire ants, fleas, ticks, crickets, earwigs, spiders, sowbugs, silverfish, clover mites, chinch bugs, armyworms, sod webworm, leaf hoppers, millipedes and certain grubs.



Not for sale in AK, HI

Item #	Desc	UPC	Vendor	CS/UOS	Location
80100124	10 lb.	037321606130	60613	4/4	National



Annual™ Tree & Shrub Insect Control

One application kills insects, and prevents new infestations for an entire year. No spraying, just mix and pour at the base of the plant. Systemic insecticide is absorbed through the roots to all parts of the plant, even new growth, and won't wash off. For use on listed fruit, nut and ornamental trees and shrubs. Kills borers (including Emerald Ash Borer & Asian Longhorned Beetle), adelgids, miners, whitefly, scale, beetles, weevils. Contains 1.47% Imidacloprid.

Item #	Desc	UPC	Vendor	CS/UOS	Location
80100126	32 oz. Con. Not For Sale in CA, CO, CT, ME, MD, MA, NV, NJ, NY, PR, RI, VT	037321006091	609	12/12	National
80100127	1 gal. Con. Not For Sale in CA, CO, CT, GA, HI, ME, MD, MA, NV, NJ, NY, PR, RI, VT	037321006114	611	4/4	National

Slug Magic® Pellets

Patented, rain proof formula makes slugs disappear! Can be used around pets and wildlife. Slug Magic can be used in fruit and vegetable gardens up to the day of harvest. 1.0% iron phosphate pellets.

Item #	Desc	UPC	Vendor	CS/UOS	Location
80100144	24 oz.	037321009047	904	12/12	National
80100040	3 lb.	037321009054	905	12/12	East

Diatomaceous Earth

For indoor/outdoor insect control In homes, barns, stables, vegetable and flower gardens. Dual mechanical mode of action works by contact and by ingestion. Insects cannot become immune to its action. Bedbugs, Asian lady beetles, box elder bugs, mites, ants, flies, fleas, spiders, other beetles and crawling insects all succumb within 24-48 hours of contact. Apply as a dust or a slurry.

Item #	Desc	UPC	Vendor	CS/UOS	Location
80100848	1.3 lb. jug	37321001201	120	12/12	National
80100711	5 lb.	037321001218	121	8/8	National

Japanese Beetle Killer

Natural pyrethrum for quick and easy kill of Japanese Beetles and many other insects. **Not for sale in AK, AZ, CA, DC, HI, ID, MT, NM, ND, OR, PR, SD, UT, WA, WY**

Item #	Desc	UPC	Vendor	CS/UOS	Location
80100152	32 oz. RTU	037321001966	196	12/12	East

BT Thuricide Spray

Controls destructive worms, and caterpillars in and around vegetable and flower gardens. Has no effect on birds, earthworms or beneficial insects such as honey bees and lady bugs. May be used on edibles right up to the day of harvest.

Item #	Desc	UPC	Vendor	CS/UOS	Location
80100862	32 oz. RTU	037321008064	8066	6/6	National
80101077	16 oz Con.	037321008033	8036	6/6	National

Captain Jack's Deadbug Brew™

Captain Jack's Deadbug Brew® contains Spinosad. Deadbug Brew kills bagworms, borers, beetles, caterpillars, codling moth, gypsy moth, loopers, leaf miners, spider mites, tent caterpillars, thrips and more! Use on fruits, vegetables, berries, citrus, grapes, nuts and ornamentals.

Item #	Desc	UPC	Vendor	CS/UOS	Location
80101045	16 oz Con. Not For Sale in AK, HI	037321002529	2526	6/6	National
80101044	32 oz RTU	037321002505	2506	6/6	National
80100353	32 oz. Con.	037321002536	253	12/12	National
80100354	32 oz. RTS Not For Sale in AK, HI	037321002550	255	12/12	National
80101047	4lb Not For Sale in AK, DC	037321002581	2586	6/6	East

Eight® Garden & Home

Controls over 130 different insect pests on fruits, roses, flowers, lawns, shrubs, trees and over 60 varieties of ornamentals. No odor, water based, indoor/outdoor. Contains Lambda-cyhalothrin insecticide.

Not for sale in AK, DC

Item #	Desc	UPC	Vendor	CS/UOS	Location
80100068	32 oz. RTU	037321004288	428	12/12	National

Eight® Yard & Garden

Permethrin 2.5% Non-staining, water based. Use as a general home and grounds spray to keep out invading ants, ticks, mosquitoes, fleas, flies... can be used directly on homes, patios, porches, garages...

Controls over 100 insects on fruit, nuts, vegetables, flowers, trees, shrubs, roses and also kills stink bugs. **Not for sale in AK, HI**

Item #	Desc	UPC	Vendor	CS/UOS	Location
80100167	32 oz. RTS	037321004264	426	12/12	National

2025

TRUSTED SINCE 1926
BONIDE®



Systemic Insect Control

Economical, long lasting insect control for ornamental gardens, shrubs and trees. Use as little as 2 tablespoons/gal. Acephate 9.4% Concentrate. Neonic alternative chemistry. **Not for sale in CA, LA, HI**

Item #	Desc	UPC	Vendor	CS/UOS	Location
80100042	16 oz. Con.	037321009412	941	12/12	East

Colorado Potato Beetle Beater

Contains Spinosad .5% Controls the tough CO Potato Beetle larvae, as well as selected leaf beetle larvae and adults - naturally. For organic production. **Not for sale in AK, AZ, CA, CO, HI, ID, MT, NV, NM, ND, OR, SD, UT, WA, WY, DC, PR**

Item #	Desc	UPC	Vendor	CS/UOS	Location
80100579	16 oz. Con.	037321006879	687	12/12	East

Pyrethrin Garden Insect Spray

Natural pyrethrin in a concentrated formula for economical, natural, broad spectrum garden insect control. Ideal for vegetables, fruits, flowers and delicate ornamentals. Use up to the day of harvest.

Not for sale in CA, DC

Item #	Desc	UPC	Vendor	CS/UOS	Location
80100617	8 oz. Con.	037321008576	857	12/12	National
80100618	32 oz Con.	037321008583	858	12/12	National

Malathion 50E Concentrate

Malathion Insect Control concentrate is labeled for use on houseplants, vegetables, fruits, and ornamentals to control a variety of insects.

Not for sale in AK, CA, HI.

Item #	Desc	UPC	Vendor	CS/UOS	Location
80101094	32 oz Con.	037321009931	9936	6/6	East

Malathion Insect Control

50.0% Cythion. A truly all-purpose insecticide. Labeled for use on fruits, vegetables and ornamentals. 16 oz. makes up to 50 gal. of spray. **Not for sale in AK, CA, HI**

Item #	Desc	UPC	Vendor	CS/UOS	Location
80100045	16 oz. Con.	037321009924	992	12/12	National

Eight® Vegetable, Fruit & Flower

Provides economical, contact and residual insect control for up to 4 weeks. Kills over 100 insects which destroy lawns, roses, flowers, trees, shrubs, vegetables, fruit, nuts, and may be applied to homes and other areas to stop infestations of flies, ticks, fleas, mosquitoes, ants... all flying, crawling & hopping insects. Even great for houseplants! Contains 2.5% Permethrin.

Item #	Desc	UPC	Vendor	CS/UOS	Location
80100027	16 oz. Con.	037321004424	442	12/12	National
80100412	32 oz. Con.	037321004431	443	12/12	National

Systemic Rose & Flower Care

2-in-1 Systemic Insecticide plus 8-12-4 Fertilizer for roses, flowers, and shrubs. Systemic Rose & Flower is specifically formulated to provide up to 8 weeks of insect control, as well as essential macro plus micro nutrients. Convenient granules. Great for container gardens. Contains 0.22% Imidacloprid. **Not for sale in CA, CO, CT, LA, ME, MD, MA, NJ, NY, RI, SD, VT**

Item #	Desc	UPC	Vendor	CS/UOS	Location
80101091	2lb	037321009443	9446	6/6	East

Systemic Granules Insect Control

Convenient, ready-to-use granules provide effective, long lasting insect control for 8 weeks. Excellent indoor no odor, no spray, no mess formula. Systemic action moves throughout the plant, even protecting new growth. Kills tough houseplant pests like fungus gnats, mealybug, whitefly, thrips and aphids. Contains Imidacloprid 0.22%. **Not for sale in CA, CO, CT, ME, MD, MA, NJ, NY, PR, RI, VT**

Item #	Desc	UPC	Vendor	CS/UOS	Location
80100148	1 lb.	037321009528	952	12/12	National
80101092	4lb.	037321095347	95349	9/9	National

Bug & Slug Killer

Bug & Slug Killer is a bait that attracts and kills snails, slugs and other crawling garden insects. Approved for organic gardening. Use to protect listed vegetables, fruits and berries.

Item #	Desc	UPC	Vendor	CS/UOS	Location
80101090	1.5 lb	037321009085	9086	6/6	National

2025



Eight® Garden Dust

An outstanding vegetable garden insecticide that kills and repels most insect pests common to home gardens. Provides contact and residual control of over 55 hard to kill insects. Designed for use on vegetables, roses and flowers. Easy to use and one application can last up to 4 weeks. **Not for sale in AK, HI**



Item #	Desc	UPC	Vendor	CS/UOS	Location
80101076	3lb	037321007869	7866	6/6	National

Tomato & Vegetable 3-1

This product is designed to kill species of aphid, spider mite, ant, cricket, weevil, caterpillar, fly, thrip, silverfish, & more. Tomato & Vegetable spray controls blackspot, powdery mildew, rust, scab, blight, brown rot, & leaf spot. For best control apply as a protective spray early in the season before the diseases are noticed. Our insect killer is perfect for use on listed fruits, vegetables, & ornamentals. This product is conveniently ready to use when it arrives at your door.



Item #	Desc	UPC	Vendor	CS/UOS	Location
80101073	32 oz RTU	037321006886	6886	6/6	National

Super Soap

Spinosad .005% plus potassium salts of fatty acids 1.94% fast acting patented formula for organic gardening to kill over 30 insects and mites on vegetables, fruit, nuts, berries, herbs, container plants, greenhouse plants, and ornamentals. Also kills powdery mildew.



Item #	Desc	UPC	Vendor	CS/UOS	Location
80100926	32 oz RTU	037321006558	6556	6/6	National

Insecticidal Soap

Potassium fatty acids from plants kill insects on contact. Great for houseplants, vegetables, flowers, fruits. Patented formula does not persist in the environment and may be used up to day of harvest. Preferred by organic gardeners. Contains no flammable solvents or animal fatty acids like other brands. **Not for sale in PR**



Item #	Desc	UPC	Vendor	CS/UOS	Location
80101098	32 oz. RTU	037321006527	6526	6/6	National

All Seasons® Horticultural Spray Oil

A superior type paraffinic oil that may be used as a growing season spray, dormant spray (no leaves) or delayed dormant (green tip) spray to control over wintering eggs of red spiders, scale insects, aphids, bud moths, leaf roller, red bug, codling moth, blister mites, galls, whitefly, mealy bugs and other insects. Highly recommended for use on fruit trees, shade trees, shrubs, ornamentals, roses and vegetables.



Item #	Desc	UPC	Vendor	CS/UOS	Location
80101039	16 oz Con.	037321002109	2106	6/6	National
80100059	32 oz. RTU Not For Sale in HI	037321002147	214	12/12	National
80100058	32 oz. RTS	037321002130	213	12/12	National
80101040	32 oz Con.	037321002116	2116	6/6	National

Bon-Neem II®

A broad spectrum fungicide, insecticide and miticide for control of insects, diseases and mites on vegetables, fruit, nuts, herbs, spices, roses, flowers, shrubs, houseplants, shrubs and more around the home. Kills stink bugs, boxelder bugs, fungus gnats plus Brown Patch, Dollar Spot (on Turf) and Snow Mold to name just a few.



Item #	Desc	UPC	Vendor	CS/UOS	Location
80100245	32 oz. RTU	037321000259	025	12/12	National

Neem Oil - Organic

An all purpose insecticide, miticide and fungicide for organic gardening. Derived from the Neem seed, Neem oil is an excellent choice for use on virtually any plant, including roses, flowers, vegetables, herbs, spices, houseplants, trees, turf and shrubs. Kills all stages of insects - eggs, larvae and adults. Makes a great dormant spray. Imparts a healthy shine to hardy leaf surfaces. Comes in an economical concentrate and convenient ready to use.



Item #	Desc	UPC	Vendor	CS/UOS	Location
80100003	16 oz. Con. Not For Sale in OR	037321000242	024	12/12	National
80101033	32 oz RTU	037321000228	226	6/6	National
80100949	1 gal RTU Not For Sale in OR	037321000235	023	4/4	National



Spider & Ground Bee Killer

Kills and repels. Our pest control is great for use on a variety of bug species including ant, spider, roach, cricket, mite, silverfish, wasp, bee, hornet, & more. Designed for indoor & outdoor use. Includes applicator cap for hard to reach areas.

Not for sale in CA, MD, PR, RI, VA, WA



Item #	Desc	UPC	Vendor	CS/UOS	Location
80101132	10oz.	037321046844	4684	12/12	West

Spider Killer

Kills spiders on contact. This long-lasting non-staining formula also kills palmetto bugs, stink bugs, Asian lady beetles, and other listed insects. Water-based formula leaves no unpleasant odor or staining in carpets or floors. **Not for sale in PR, ME, OR, RI**



Item #	Desc	UPC	Vendor	CS/UOS	Location
80101120	1 gal RTU	037321046868	4686	4/4	West

Termite & Carpenter Ant Killer

Indoor/Outdoor formula termite and carpenter ant killer. Contact kill provides immediate results when spraying insects directly. Powerful, long-lasting Deltamethrin provides indoor or outdoor protection from carpenter ants and other wood infesting insects when they return to treated areas. **Not for sale in PR**



Item #	Desc	UPC	Vendor	CS/UOS	Location
80101119	Aerosol 15oz.	037321046233	4623	12/12	West

Mosquito Beater® Repellent

Residual formula repels mosquitoes, gnats, flies and other nuisance insects for up to 2 weeks. Made with natural ingredients. Great for lawns, patios, gardens, barns....Any outdoor area. Pleasantly scented. 1 quart treats 5000 sq. ft. Convenient, no-mix ready-to-spray applicator.



Item #	Desc	UPC	Vendor	CS/UOS	Location
80100183	Fogger 15oz. Not For Sale in CA, DC	037321005605	560	12/12	West
80100074	4m Granular Not For Sale in DC	037321056126	5612	12/12	National
80101072	32 oz RTS Killer Not For Sale in HI	037321006800	6806	6/6	National
80101069	32 oz RTS Not For Sale in DC, IN, KS	037321005643	5646	6/6	National

Neem Max Conc.

Neem Max is an organic plant-based, botanical product that contains the full spectrum of bioactive compounds that stops the insect lifecycle. This 4-in-1 product is a fungicide, insecticide, miticide & nematocide. Apply as a spray or as a drench to protect your plants from insects and diseases.



Item #	Desc	UPC	Vendor	CS/UOS	Location
80101032	8oz Con. Not For Sale in PR	037321000204	20	12/12	National
80101141	8oz RTU Houseplants Not For Sale in CA, IA, PR, SD	037321001171	117	12/12	National
80101034	16 oz Con. Not For Sale in PR	037321000266	26	6/6	National

Revenge Flea Fogger

Flea Fogger prevents fleas from developing into the biting adult stage. It also kills other species of insects including cockroaches, brown dog ticks, spiders, ants, & other listed insects. It does not control bed bugs.

Not for sale in ME, PR



Item #	Desc	UPC	Vendor	CS/UOS	Location
80101121	6oz.3pk.	037321046134	4613	12/12	West

House Guard

Kills roaches, ants, bedbugs, fleas, spiders and ticks. Expanding Foam Spreads deep into hard to reach places. Keeps killing roaches for up to 18 months. Non-staining formula does not stain where you put it.



Item #	Desc	UPC	Vendor	CS/UOS	Location
80101014	Aerosol 15oz. Not For Sale in ME, NE	037321466406	46640	12/12	West
80101130	32 oz RTU Not For Sale in ME	037321046509	4650	6/6	West
80101012	1 gal RTU Not For Sale in ME	037321465409	46540	4/4	West

Ant & Roach Killer

Weather resistant formula granules kill ants before they become a problem in your house. Kills within 24 hours. Quick acting killer can also be used indoors for ant control. Kills both sweet and grease eating ants, kills the entire colony, kills roaches, crickets, mole crickets, slugs, snails, earwigs and silverfish. **Not for sale in AK, DC, HI**



Item #	Desc	UPC	Vendor	CS/UOS	Location
80100170	1lb. Dust	037321455028	45502	12/12	National
80100171	1.5lb. Granules	037321456025	45602	12/12	National



Go Away! Deer & Rabbit Repellent

The formula used to create the granules does not act as a poison, and it will not harm the animals. It is safe to use this product around areas where children play as long as it is used as directed. It is perfect for deterring animals as the scent is unpleasant to them and keeps them away from the area. Use this product exactly as directed for optimal protection. One container can treat up to 900 square ft.

Item #	Desc	UPC	Vendor	CS/UOS	Location
80101042	32oz. Not For Sale in AK, HI, PR	037321002307	2306	6/6	National
80100346	Gran.3lb. Not For Sale in AL, IN, NM, OH, PR	037321002277	227	12/12	National

Rat Magic®

The perfect sister product to our popular Mouse Magic, Rat Magic® is designed for outdoor use to repel rodents such as rats, chipmunks and squirrels. This unique combination of essential oils is people and pet safe, and biodegradable. 5lbs. treats up to 1000 sq. ft. or a 2 ft. barrier that's 500 ft. long. **Not for sale in IN, MD, NM**

Item #	Desc	UPC	Vendor	CS/UOS	Location
80101084	5lb	037321008637	8634	4/4	National

MoleMax® Granules

Mole and vole repellent granules and bulb protector. Repel moles, voles, gophers, rabbits, armadillos, skunk... in lawns, flower beds, gardens... Clean, dustless, biodegradable granules are safe for use around children, plants and pets. 1 lb. treats 500 sq. ft. and lasts up to 3 months. Contains Rucinus Communis Oil. **Not for sale in IN, DC**

Item #	Desc	UPC	Vendor	CS/UOS	Location
80101074	5lb	037321006916	6914	4/4	National
80100194	10 lb. Bag	037321006923	692	4/4	National

Shot-Gun Repels-All Animal Repellent Rtu

Deer and Rabbit Repellent protects flowers, shrubs, vegetables, fruit, bulbs, lawns, trees...from deer, rabbits, squirrels...both an odor and a taste barrier. All natural ingredients. Leaves no noticeable residue. Lasts 3 months. Contains putrescent whole egg solids, garlic and capsaicin. **Not for sale in IN, NM**

Item #	Desc	UPC	Vendor	CS/UOS	Location
80101099	32 oz RTU	037321002383	2386	6/6	National

Chipmunk, Squirrel, Rodent Repellent

Naturally drive rats, chipmunks, squirrels and other rodents from premises, around homes, barns, stables, patios, garages, trash cans, wood piles. Biodegradable and people & pet safe.

Not for sale in AK, CT, DC, IN, KY, ME, MS, NM, NV, SD, PR

Item #	Desc	UPC	Vendor	CS/UOS	Location
80100928	32 oz RTS	037321008682	868	6/6	East

MoleMax® RTS

MoleMax® repels moles, voles, gophers, rabbits, and other listed rodents. Lasts up to 3 months, when used as directed. It penetrates deep into the soil where animals burrow for maximum efficacy.

Not for sale in IN, NM, WI, DC

Item #	Desc	UPC	Vendor	CS/UOS	Location
80100586	32 oz	037321006909	690	12/12	National

Repels-All®

All natural ingredients. Repels three ways: by sense of touch, taste and smell. Protects plants and property including structures for up to 2 months per application. Rain fast after 6 hours. Most comprehensive animal repellent available. Contains garlic, dried blood, whole egg solids, clove, fish oil, onion and wintergreen.

Item #	Desc	UPC	Vendor	CS/UOS	Location
80101097	32 oz. Con. Not For Sale in IN, NM, PR	037321002376	2376	6/6	National
80101043	32 oz RTS Not For Sale in IN, NM	037321002406	2406	6/6	National

Hot Pepper Wax Animal Repellent

A natural repellent for use on fruits, vegetables and ornamentals. Even stops animals from chewing wood structures and fences. One application can last up to 4 weeks. Made from hot cayenne peppers. **Not for sale in AK, PR**



Item #	Desc	UPC	Vendor	CS/UOS	Location
80100274	32 oz. RTU	037321001270	127	12/12	National

2025

TRUSTED SINCE 1926
BONIDE®



Repels-All® Granules

A convenient granular formulation of the all-natural and popular Repels-All® liquid. Triggers genetically and biologically ingrained fear and flight responses in a multitude of animal intruders - without harm. Lasts up to 2 months. Protects plants and property - year round. Organic and biodegradable. **Not for sale in IN, NM**

Item #	Desc	UPC	Vendor	CS/UOS	Location
80101095	1.25 lb.	037321023609	23606	6/6	National
80101096	3 lb.	037321023616	23614	4/4	National
80100016	6 lb.	037321023623	2362	4/4	National

Moletox II

Effectively kills moles and pocket gophers. Crack corn based bait can be place in an active run or tunnel. Can also be used to protect flower bulbs by using Bonide Moletox II around the bulb and covering with soil. 1# container. **Not for sale in CA, ME, NH, PR**

Item #	Desc	UPC	Vendor	CS/UOS	Location
80100234	1 lb	037321006985	698	12/12	National

Go Away! Rabbit, Dog, & Cat Repellent

Go Away! Rabbit, Dog & Cat Repellent Granules by Bonide effectively and naturally repel animals and deter them from forbidden areas in your yard, lawn and garden. Use this product as a training aid! While this product is an animal behavior modification tool, it may need to be supplemented with other behavior modification techniques to break domestic animals and pets of existing bad habits. **Not for sale in IN, NM**

Item #	Desc	UPC	Vendor	CS/UOS	Location
80100196	1.5lb	037321008705	870	12/12	West

Snake Repellent

Repel snakes and other pests from your yard and garden with Snake Stopper Snake Repellent Granules from Bonide! Natural ingredients keep snakes away from your yard by triggering their escape and avoidance behavior, without causing any harm! Cinnamon Oil, Cedarwood Oil, and Clove Oil create a strong smell and taste to naturally deter snakes, iguanas and lizards. **Not for sale in AK, DC**

Item #	Desc	UPC	Vendor	CS/UOS	Location
80100627	1.5lb	037321087519	8751	12/12	West

Gophertox®

REVENGE® Gophertox® Gopher Killer is a poison bait to kill pocket gophers in your lawn. This product helps protect flower bulbs in the fall and can be used on lawns. **Not for sale in NH, PR**



Item #	Desc	UPC	Vendor	CS/UOS	Location
80100592	1lb	037321006954	695	12/12	West

MoleMax® Sonic Spike

Exclusive "Chatter Sound" technology mimics predator warning. Effective on most burrowing rodents. Superior components for year -round use. Patented "open wave" tip for maximum sound release. Normal "C" cell battery version designed for 18 month extended battery life.

Not for sale in OK, DC, PR



Item #	Desc	UPC	Vendor	CS/UOS	Location
80100967	Spike	037321611189	61120	6/6	National

Mouse Magic®

The all natural ingredients in Mouse Magic triggers "escape/avoidance" behaviors in mice driving them from homes, sheds, and patios. Simply locate "place packs", which exude the repelling quality of the essential oils, any where mice enter, feed or nest. Repels for over 30 days in laboratory tests. **Not for sale in DC, IN, NM**



Item #	Desc	UPC	Vendor	CS/UOS	Location
80100153	4 pk.	037321008651	865	12/12	National
80100243	12 Pk.	037321008668	866	6/6	National

Bat Magic®

Drives bats from attics, blinds, wall voids, chimneys, and other confined spaces they like to hide in. Contains natural, essential oils packaged in convenient simple to use "place packs". **Not for sale in IN, NM, WI, DC**



Item #	Desc	UPC	Vendor	CS/UOS	Location
80100631	4 pack	037321008767	876	12/12	National

TRUSTED SINCE 1926
BONIDE® SPECIALTY



Poison Ivy & Oak Killer

BONIDE Poison Ivy & Oak Killer is a systemic weed killer designed to control weeds to the root. It won't harm lawngrass and is safe and effective to use when used as directed. Product is rainfast after application is dry. **Not for sale in AK, AZ, CA, CO, HI, ID, MT, NM, ND, OR, SD, UT, WA, WY, PR**

Item #	Desc	UPC	Vendor	CS/UOS	Location
80101066	32 oz RTU	037321005063	5066	6/6	National

Sucker Punch

A plant growth regulator that stops suckers sprouting from roots and pruning cuts of ornamental trees, fruit trees and other woody plants. Lasts 6 months. Spray on RTU trigger and brush on, brush top applicators included.

Not for sale in OR

Item #	Desc	UPC	Vendor	CS/UOS	Location
80100754	16 oz RTU	037321027614	2761	6/6	West

Stump-Out

BONIDE Stump-Out® accelerates the decomposition of seasoned tree stumps to allow them to easily be burned out or chopped out of the ground. Works in 4 - 6 weeks.

Item #	Desc	UPC	Vendor	CS/UOS	Location
80101063	1lb Granules	037321002727	2726	6/6	National

Stump & Vine Killer

Kills stumps and vines without harming turf. Contains brush applicator for an easy application. Kills poison oak, poison ivy and more. **Not for sale in AK, HI, VT**

Item #	Desc	UPC	Vendor	CS/UOS	Location
80101064	8 oz Concentrate	037321002741	2746	6/6	National

Rot-Stop® Concentrate

Nutritional Calcium corrects calcium deficiency. Controls blossom end rot on tomatoes, other vegetables. Apply to developing fruit and foliage after periods of heavy rain or rapid growth. 4 tbsp./gal.



Item #	Desc	UPC	Vendor	CS/UOS	Location
80100211	8 oz. Concentrate	037321001669	166	12/12	National
80101036	32 oz RTU Not For Sale in MD	037321001676	1676	6/6	National

Tomato & Blossom Set Spray

Makes blossoms set fruit despite poor weather. Nearly every blossom will produce larger, meatier, almost seedless tomatoes, ripening up to 3 weeks earlier. Also for use on other vegetable plants! Contains natural plant growth hormone Kinetin.



Item #	Desc	UPC	Vendor	CS/UOS	Location
80101067	8 oz RTU Not For Sale in CA, HI, PR	037321005438	5436	6/6	National
80101068	32 oz. RTU Not For Sale in CA, HI, LA, PR	037321005445	5446	6/6	West

Pruning Sealer With Brush-Top

Pruning sealer, A fast, easy and effective dressing designed to aid healing of pruning cuts, grafts and wounds on trees and shrubs, including roses and fruit trees, Provides a protective coating to prevent the entry of moisture and the excessive flow of sap, Can also be used for waterproofing various planting pots and tubs, Contains petroleum asphalt and aliphatic petroleum solvent, Brush top, 16 oz.



Item #	Desc	UPC	Vendor	CS/UOS	Location
80100162	16 oz	037321002253	225	12/12	National

FUNGICIDES

Copper Fungicide

This patented, copper formulation protects a wide range of plants from turf to veggies, to fruit and flowers from a host of listed diseases. Great for Blight! Suitable for organic gardening. Dust or Spray - Copper Sulfate 7.0%. Liquid - Copper Octanoate.



Item #	Desc	UPC	Vendor	CS/UOS	Location
80100034	1 lb. Shaker Not For Sale in AK, CA, PR	037321007715	771	12/12	National
80101078	16 oz Concentrate Not For Sale in DC	037321008118	8116	6/6	National
80100929	16 oz RTS	037321008132	813	6/6	National
80100932	32 oz RTS	037321008149	814	6/6	National
80101075	32 oz RTU	037321007753	7756	6/6	National



Revitalize Bio

A high potency biofungicide/bactericide that controls many diseases and is suitable for organic gardening. Triggers plant immune response



Item #	Desc	UPC	Vendor	CS/UOS	Location
80100911	16 oz Con	037321007777	777	12/12	East

Fung-onil®

Truly all purpose. Controls numerous diseases on roses, flowers and vegetables, fruit and shade trees. Contains Chlorothalonil, commonly known as Daconil. **Not for sale in AK, HI RTU: Not for sale in HI**



Item #	Desc	UPC	Vendor	CS/UOS	Location
80100038	16 oz Con.	37321008804	880	12/12	National
80101088	32 oz RTU	037321008835	8836	6/6	National

Sulfur Dust

90% Sulfur. A specially prepared micronized sulfur suitable for use as a dust or spray. The fine particle size gives better coverage, adhesion and disease control. This product controls a large number of diseases on fruits, vegetables and various ornamentals. Approved for organic gardening. Now labeled for chiggers. **Not for sale in AK, DC, PR**



Item #	Desc	UPC	Vendor	CS/UOS	Location
80100156	1 lb.	037321001416	141	12/12	National
80101035	4lb	037321001423	1428	8/8	National

Infuse Systemic Disease Control Concentrate

Bonide Infuse Systemic Disease Control Concentrate prevents and controls over 30 plant diseases, including tough to control soil borne pathogens. The formula is ideal for use on bulb, annual and perennial flowers, bedding plants and ground covers, deciduous and evergreen trees and shrubs. **Not for sale in AR, HI, IN, KY, LA, DC**



Item #	Desc	UPC	Vendor	CS/UOS	Location
80100053	16 oz Con.	037321001485	148	12/12	National

TRAPS

Beetle Bagger™ Japanese Beetle Trap

These irresistible, dual Floral/Pheromone lure systems protect 5,000 sq. ft., all season long! The hourglass shaped disposable collection bags trap beetles securely. Attractive display box goes anywhere - shelf displays, counter tops, peg hook displays. Each kit contains 1 trap, 1 dual-lure and 2 collection bags. **Not for sale in DC. Not for sale in AK, AZ, CA, HI, ID, MT, NV, NM, ND, OR, UT, WA, WY, DC, PR**



Item #	Desc	UPC	Vendor	CS/UOS	Location
80100055	Trap Kit	037321001973	197	24/24	East
80100010	Trap Lures	037321019725	1972	12/12	East
80100009	Bags 6/pk	037321019718	1971	24/24	East

Revenge® Moth Traps

Insect Traps with Pheromone Lure, attracts and captures pantry pests. For kitchens, cupboards, pet food, bird seed. Non-toxic and odorless. Lasts for 3 months. **Not for sale in WY, DC**



Item #	Desc	UPC	Vendor	CS/UOS	Location
80100006	2 pack	076807007009	124	48/12	East

Revenge® Fly Catchers

The original fly catching ribbon. Guaranteed not to dry out in the package or in use. EZ Grab tab makes deployment simple. Odorless and for use indoors or in outbuildings. **Not for sale in DC, PR**



Item #	Desc	UPC	Vendor	CS/UOS	Location
80100768	100 pack Shelf Display	37321461265	46126	100/100	East

Revenge® Jumbo Fly Catchers

8 feet of our UV stable, non-drying "memory glue" - won't adhere to skin. One sided coating for clean, EZ application to walls, ceilings, poles, even trees. A nice big 7.25" wide roll for maximum fly catching capacity. **Not for sale in DC, PR**



Item #	Desc	UPC	Vendor	CS/UOS	Location
80100424	12 pk	076807000451	46220	12/12	East



Houseplant Insect Killer and Mite Control

Houseplant Insect & Mite Control kills and controls listed insects, mites and controls listed fungal diseases, all in just one product. The insect killer fights to kill and control ants, earwigs, fruit flies, lace bugs, loopers and more.



Item #	Desc	UPC	Vendor	CS/UOS	Location
82270140	24 oz RTU	840216200036	800100B	8/8	National

Home Pest Bed Bug & Flea Killer

Roach killer indoor, insect killer: kills bed bugs, ticks, fleas, crawling pests and other listed insects. Up to 30 days protection: kills bed bug eggs before they hatch and other listed insects for up to 30 days.



Item #	Desc	UPC	Vendor	CS/UOS	Location
82270081	15 oz	687073013207	701320A	12/12	National

Vegetable & Garden Insect Spray

Kills over 70 listed insects including aphids, caterpillars, thrips, tomato hornworm, and whiteflies. Protect fruits and vegetables from insect damage, for outdoor use. Active ingredient 0.75% Cyfluthrin.



Item #	Desc	UPC	Vendor	CS/UOS	Location
82270072	32 oz Concentrate	687073015218	701521A	8/8	National

Home Pest Control Plus Germ Killer

Ready to Use Home Pest Killer Plus Germ Killer. Kills insects and reduces 99% of the germs that they may leave behind.

Not for sale in CA, ME



Item #	Desc	UPC	Vendor	CS/UOS	Location
82270054	24 oz RTU	840216200104	800300A	12/12	National
82270055	1 gal RTU	840216200111	800301A	12/12	National

Tomato & Vegetable Insect Killer

Kills listed pests, such as aphids, adult Japanese beetles, cutworms. Leafy, fruiting and root vegetables such as tomatoes, peppers, carrots, as well as on cucurbits. Active ingredient Cyfluthrin.

Not for sale in CA



Item #	Desc	UPC	Vendor	CS/UOS	Location
82270073	24 oz RTU	687073075236	707523A	8/8	National
82270058	32 oz RTS	687073075229	707522A	8/8	National

Tomato, Vegetable & Fruit Insect Control

Kills on contact to protect your edibles against Aphids, Caterpillars, Mealybugs, Spider Mites and other listed pests. Use to protect edibles such as vegetables, fruit and nut trees, citrus, berries, herbs and outdoor container-grown plants.



Item #	Desc	UPC	Vendor	CS/UOS	Location
82270021	24 oz RTU	840216200470	820047B	8/8	National

3-in-1 Fruit & Vegetable Solution Concentrate

3 benefits in one bottle: kills insects, mites and diseases. Kills pests on contact such as aphids, caterpillars, fruit flies, mealy bugs, spider mites and leafhoppers. Use up to day before harvest on fruits and vegetables. Use indoors and outdoors.



Item #	Desc	UPC	Vendor	CS/UOS	Location
82270175	32 oz Concentrate	687073075007	707500E	4/4	National

Fruit, Citrus & Vegetable Insect Control

Perfect solution to prevent insects from destroying your plants. 32 oz., concentrate, Fruit, Citrus, and Vegetable Insect Control. This formula will provide you with season long protection. Kills insects instantly, and prevents new infestations from occurring. Specially formulated for edible plants. Formula is rainproof one hour after application.

Active ingredient Imidacloprid. **32oz Not For Sale CO, CT, MA, ME, NJ, RI, VT**



Item #	Desc	UPC	Vendor	CS/UOS	Location
82270013	24 oz Concentrate	840216200364	801500E	4/4	National
82270071	32 oz Concentrate	687073015201	701520A	8/8	National

BIOADVANCED
 SCIENCE-BASED SOLUTIONS

Rose & Flower Insect Killer

Ready to Use Dual Action Rose & Flower Insect Killer. Fast acting and lasts up to three times longer than competitive products - Based on product label comparisons. **24oz RTU Dual Action not for sale in CO, CT, MA, ME, NJ, NV, NY, RI, VY**



Item #	Desc	UPC	Vendor	CS/UOS	Location
82270135	15oz Continuous Spray	687073013306	701330A	12/12	National
82270120	24 oz RTU Dual Action	687073025705	502570B	12/12	National
82270139	24 oz RTU	687073085709	708570A	12/12	National

All In One Rose & Flower Care

All-in-One Rose & Flower Care, Granules, 4lb., is convenient, easy-to-use and takes the guesswork out of application. Fertilizer, insect control and disease control in one application without spraying! Systemic formula cannot be washed off by rain.



(Imidacloprid) **Not for sale in CA, CT, MD, VT, ME, MA, NJ, NY, CO, RI**

Item #	Desc	UPC	Vendor	CS/UOS	Location
82270123	4lb Granular (Imidacloprid)	687073011104	701110A	6/6	National
82270129	32oz Concentrate (Imidacloprid)	687073012606	701260B	8/8	National
82270131	64oz Concentrate (Imidacloprid)	687073012620	701262B	4/4	National

(Non-Neonic)

Item #	Desc	UPC	Vendor	CS/UOS	Location
82270125	4lb Granular (non-neonic) Not for sale in NY	687073011166	701116E	6/6	National
82270192	24oz RTU (non-neonic)	840216201569	820156B	8/8	East
82270009	32oz Concentrate (non-neonic) Not for sale in NY	840216200616	708260D	8/8	National
82270191	32oz Concentrate (non-neonic)	840216200616	820061B	8/8	West
82270193	1 gal (non-neonic) Not for sale in NY	840216201576	820157E	4/4	East

Shrub Care Protect & Feed Granules

Shrub Care Protect & Feed 4lb Granules provides 6-weeks of systemic protection against damaging listed insects, including Aphids, Cuban Laurel Thrips (Ficus), adult Japanese beetles, Leafhoppers, Root Weevils and more. It controls listed diseases like Black Spot, Powdery Mildew, Rust and Southern Blight. 6-9-6 Fertilizer Active ingredients Acephate, Tebuconazole. **Not for sale in NY**



Item #	Desc	UPC	Vendor	CS/UOS	Location
82270151	4 lb	840216200029	801000A	6/6	National

2 In 1 Rose & Flower Care Granules

2-in-1 Systemic Rose & Flower Care feeds plus protects against listed insects in one easy step. Controls aphids, lace bugs, leafhoppers and thrips. Promotes strong roots and beautiful blooms. Rainproof protection lasts up to 6 weeks.



(Imidacloprid)

Item #	Desc	UPC	Vendor	CS/UOS	Location
82270136	5lb Granular (non-neonic) *CA	687073081107	708110A	6/6	West

(Non-Neonic)

Item #	Desc	UPC	Vendor	CS/UOS	Location
82270121	5lb Granular (Imidacloprid) Not for sale in AK, AZ, CA, CO, CT, DC, DE, GU, HI, IA, ID, IN, KS, KY, MA, MD, ME, MI, MN, MO, MT, ND, NE, NH, NJ, NM, NV, NY, OH, OR, PA, PR, RI, SD, UT, VA, VT, WA, WI, WV, WY	687073011005	701100A	6/6	National
82270127	10lb Granular (Imidacloprid) Not for sale in CO, CT, MA, MD, ME, NJ, RI, VT	687073012101	701210A	4/4	National

Tree and Shrub Protect & Feed Granules

Tree and Shrub Protect and Feed Granules provides 12-month long-lasting systemic protection against damaging insects including adelgids, aphids, borers, Japanese beetles, leaf miners, scale and white flies plus feeds in a single application. It provides slow-release feeding and no spraying required. Having beautiful trees and shrubs has never been easier. Concentrate active ingredients Merit insecticide, Clothidin and feeds with 2-1-1 Fertilizer. *NY* Versions contain active ingredient Merit insecticide and 2-1-1 fertilizer.



Item #	Desc	UPC	Vendor	CS/UOS	Location
82270145	32oz Concentrate	687073018103	701810A	8/8	National
82270147	4lb Granular NY Version Not for sale in CO, CT, MA, MD, ME, NJ, RI, VT	687073019001	701900B	6/6	National

(Non-Neonic) **Not for sale in CO, CT, MA, MD, ME, NJ, RI, VT**

Item #	Desc	UPC	Vendor	CS/UOS	Location
82270148	32oz Concentrate (non-neonic)	687073019018	701901A	8/8	National
82270143	4lb Granular (non-neonic)	687073017007	701700B	6/6	National

Disease Control For Roses Flowers & Shrubs

This concentrate will make up to 42 gallons of spray. Controls black spot, powdery mildew, crabapple scab, rust, boxwood blight and other listed diseases. Best used to treat roses, flowers, trees, shrubs and even some houseplants. Systemic rainproof protection lasts up to 2 weeks! **Not for sale in NY**



Item #	Desc	UPC	Vendor	CS/UOS	Location
82270128	32oz Concentrate	687073012507	701250B	8/8	National



Pest Insect Killer

Home Pest Insect Killer is a versatile insect killer for indoor and outdoor use. Kills ants, fleas, roaches, scorpions, spiders and other listed insects. Kills fleas for up to 12 months. Kills over 50 listed insects. Great for use on houseplants. **Not for sale in CO, CT, MA, MD, ME, NJ, NY, RI**



Item #	Desc	UPC	Vendor	CS/UOS	Location
82270080	15 oz	687073013108	701310A	12/12	National

3-in-1 Insect Disease & Mite Control

Triple protection for flowering plants, trees and shrubs. Kills and controls insects. Cures and prevents fungal disease. Controls spider mites. Protects up to two times longer against twice as many pests versus other brands. Systemic rain proof protection lasts up to 30 days. Active ingredients imidacloprid, tau-fluvalinate and tebuconazole.



Not for sale in CO, CT, MA, MD, ME, NJ, NV, NY, RI, VT

Item #	Desc	UPC	Vendor	CS/UOS	Location
82270134	24oz RTU	687073012903	701290B	12/12	National
82270132	32oz Concentrate	687073012859	701285B	8/8	National

(Non-Neonic)

Item #	Desc	UPC	Vendor	CS/UOS	Location
82270195	24oz RTU (non-neonic)	840216201385	820138B	8/8	East
82270197	32oz Concentrate (non-neonic)	840216200654	820065B	8/8	National
82270196	32oz RTS (non-neonic)	840216200647	820064B	8/8	National

Brush Killer Plus Quart Concentrate

Brush Killer Plus Concentrate kills tough brush and viney weeds, roots and all. This formula kills kudzu, poison ivy, poison oak and blackberries-over 75 hard to kill plants in all. Active ingredients Triclopyr, triethylamine salt.



Item #	Desc	UPC	Vendor	CS/UOS	Location
82270066	24 oz RTU	687073046304	704630D	6/6	National
82270067	32 oz Concentrate	687073046403	704640B	8/8	National
82270068	32 oz RTS	687073046458	704645A	8/8	National
82270069	1 gal RTU	687073046557	704655A	4/4	National
82270070	1.3 gal RTU power spray	687073047011	704701A	4/4	National

Extended Control Brush Killer

Extended Control Brush Killer its name is the full year of control-365-days-against tough brush such as poison ivy, poison oak, kudzu, blackberry and other listed brush. Our formula kills the root. You will enjoy 12-months of protection. This 32 oz. concentrate covers 4,000 sq. ft. and can also be used to kill Stumps. Get more from the blue bottle.



Item #	Desc	UPC	Vendor	CS/UOS	Location
82270174	32 oz Concentrate	825216200258	800600B	8/8	National
82270173	1.3 gal	825216200272	800620A	4/4	National

Carpenter Ant & Termite Killer Plus

Kills ants, termites, fleas, ticks, crickets, spiders, flies, and more. Even controls carpenter bees. Pump style sprayer with adjustable nozzle. Use on lawns, landscapes foundations, decks, and around home structures.



Item #	Desc	UPC	Vendor	CS/UOS	Location
82270156	1gal Concentrate Not for sale in NY	687073003154	700315A	4/4	National
82270157	1 gal RTU	687073003321	700332A	4/4	National
82270158	1.3 gal power spray	687073003352	700335A	4/4	National

Termite Killer Granules

Termite Killer Granules prevents listed nuisance pest from getting inside your home by creating a protective barrier that lasts for up to 30 days. Just sprinkle and water in. The exclusive formula kills and protects against such listed insects as termites, ants, centipedes and digger wasps.



Not for sale in CO, CT, MD, NJ, NY, VT

Item #	Desc	UPC	Vendor	CS/UOS	Location
82270004	9 lb	687073003505	700350L	4/4	National

(Non-Neonic)

Item #	Desc	UPC	Vendor	CS/UOS	Location
82270008	9 lb (non-neonic)	687073003703	700370A	4/4	National

Termite & Carpenter Bee Killer Plus Foam

Termite and Carpenter Bee Killer Plus Foam kills termites you see and those you don't see on contact. Its broad-spectrum foam expands to cover hard-to reach areas both indoors and out. Can be used on lawns, landscapes, foundations, decks, patios, wood piles and wooden elements in basements, crawl spaces, attics, decks, fencing and other listed areas. **Not for sale in MD,VT, NJ**



Item #	Desc	UPC	Vendor	CS/UOS	Location
82270159	18oz Foam	687073004205	700420A	12/12	National



Transparent Bird Gel

Transparent Bird Gel is a sticky repellent used to prevent birds from landing on horizontal surfaces. This bird repellent gel stops birds from perching on ledges, I-beams, parapet walls, signs, conduits, pipes, and more. This product should not be used around protected bird species.



Item #	Desc	UPC	Vendor	CS/UOS	Location
82670044	10oz 12 tubes in a case	764176427541	TBG-CASE	1/1	West

Flash Tape Visual Bird Deterrent

Flash Tape is a visual bird deterrent made from a highly reflective, shiny mylar film and is used to scare birds from outdoor areas. It can keep pest birds away from fruit trees, gardens, vines, pool areas, patios, gazebos, overhangs, boats, and more! Each roll of flash tape is 50' long and is meant to be cut into strips and attached to affected areas. Flash Tape is great for repelling pest birds including pigeons, woodpeckers, seagulls, swallows, sparrows, starlings, crows, blackbirds, grackles, ducks, geese, etc.



Item #	Desc	UPC	Vendor	CS/UOS	Location
82670026	1" x 50'	764176010507	MMFT-050	12/12	West



Bird-B-Gone Stainless Steel Bird Spikes

Bird-B-Gone Stainless Steel Bird Spikes are a humane and effective way to deter larger birds from landing and nesting on your home or business.

Item #	Desc	UPC	Vendor	CS/UOS	Location
82670022	5" 6-1ft	764176050619	MM2001-5-6	6/6	West
82670021	5" 20-1ft	764176080012	MM2001-5-20	4/4	West



Bobbex Deer Repellent

Bobbex Deer Repellent is the most effective long-lasting spray on the market. Bobbex is environmentally compatible, using only natural ingredients that stop deer browsing by using multiple smell and taste deterrents and WILL NOT WASH OFF. Bobbex can be used on all ornamental shrubs and flowers, and around vegetables.

Item #	Desc	UPC	Vendor	CS/UOS	Location
82870001	32 oz. RTU	731340100036	B550110	12/12	East
82870002	32 oz. Concentrate	731340100012	B550100	12/12	East
82870004	48 oz. RTU Pump	731340100135	B550170	8/8	East
82870003	64 oz. Concentrate	731340100029	B550105	6/6	East
82870005	1 gal. RTU Refill	731340100197	B550200	4/4	East



Bobbex-R Animal Repellent

This specially formulated spray is designed to stop smaller herbivores from eating ornamental and vegetable plants. Bobbex-R is effective in preventing rabbits, groundhogs, chipmunks, squirrels, and voles from devastating landscapes and gardens. Bobbex-R is environmentally compatible, using only natural ingredients that WILL NOT WASH OFF. Bobbex-R is recommended as a bulb-dip to deter underground damage after planting.

Item #	Desc	UPC	Vendor	CS/UOS	Location
82870007	32 oz. RTU	031340100068	B550125	12/12	East
82870008	32 oz. Concentrate	031340100051	B550120	12/12	East
82870010	48 oz. RTU Pump	031340100174	B550190	8/8	East
82870009	64 oz. Concentrate	031340100075	B550130	6/6	East
82870011	1 gal. RTU Refill	031340100204	B550205	4/4	East

Yard & Garden Insect Killer

Final Stop® Yard & Garden Insect Killer Spray produces remarkable results, because all the ingredients are formulated to perform different tasks and functions synergistically. Our unique combination of natural ingredients works to kill immediately, yet controls insects for weeks with continued protection.



Item #	Desc	UPC	Vendor	CS/UOS	Location
81160165	24oz. Concentrate	749688240284	1022	12/12	West
81160164	24oz. RTU	749688649223	8003	12/12	West
81160180	32oz. RTS	749688320283	8004	12/12	West

House Plant Insect Killer

House Plant Insect Killer Spray produces remarkable results, because all the ingredients are formulated to perform different tasks and functions synergistically. Our unique combination of natural ingredients works to kill immediately, yet controls insects for weeks with continued protection.



Item #	Desc	UPC	Vendor	CS/UOS	Location
81160136	12oz. RTU	749688079990	7999	6/6	West

Disease Control Fungicide

Disease Control Fungicide is a protective dormant spray that provides year-round disease control on trees, shrubs, lawns flowers and edibles. Our unique combination of natural ingredients kills and controls powdery mildew and other mold. Kills on contact while providing continued protection for weeks.



Item #	Desc	UPC	Vendor	CS/UOS	Location
81160156	24oz. Concentrate	749688240222	1023	12/12	West
81160157	24oz. RTU	749688649285	8007	12/12	West
81160177	32oz. RTS	749688320221	7004	12/12	West

Vegetable Garden Insect Killer

Vegetable Garden Insect Killer Spray produces remarkable results because all the ingredients are formulated to perform different tasks and functions synergistically. Our unique combination of natural ingredients works to kill immediately, yet controls insects for weeks with continued protection.



Item #	Desc	UPC	Vendor	CS/UOS	Location
81160005	24oz. RTU	749688649261	8005	12/12	West

Pest Control Killer

Pest Control Killer Spray produces remarkable results because all the ingredients are formulated to perform different tasks and functions synergistically, in a controlled fashion. Our unique combination of natural ingredients works to kill immediately, yet controls insects for weeks with continued protection.



Item #	Desc	UPC	Vendor	CS/UOS	Location
81160159	24oz. RTU	749688649230	8000	12/12	West

Snail & Slug Killer

Snail & Slug Killer Spray produces remarkable results, because all the ingredients are formulated to perform different tasks and functions synergistically, in a controlled fashion. Our unique combination of natural ingredients works to kill immediately, yet controls snails and slugs for weeks with continued protection.



Item #	Desc	UPC	Vendor	CS/UOS	Location
81160161	24oz. RTU	749688649278	8001	12/12	West

Weed & Grass Herbicide

Weed & Grass Herbicide Killer Spray is a herbicide that produces remarkable results, because all the ingredients are formulated to perform different tasks and functions synergistically, in a controlled fashion. Our unique combination of natural ingredients works to kill immediately.



Item #	Desc	UPC	Vendor	CS/UOS	Location
81160163	24oz. RTU	749688649216	8002	12/12	West

Rose & Flower Insect Killer

Rose & Flower Insect Killer Spray produces remarkable results, because all the ingredients are formulated to perform different tasks and functions synergistically. Our unique combination of natural ingredients works to kill immediately, yet controls insects for weeks with continued protection.



Item #	Desc	UPC	Vendor	CS/UOS	Location
81160160	24oz. RTU	749688649247	8008	12/12	West



Insect Guard

Helps keep bugs and swarming insects off of your plants. Material is breathable allowing sunlight and air to pass through so that your plants can continue to grow. Designed to float over crops without any support to help keep them protected.



Item #	Desc	UPC	Vendor	CS/UOS	Location
82170157	5' x 40'	016069006907	ING-40	8/8	National

Baby Owl Pest Deterrent Decoy

Scarecrow baby owl. 10.6 inches tall and hand painted for realism and effectiveness. A simple and effective way to deter unwanted pests from your garden. Effective against rabbits, rats, birds, and other vermin. Made from recycled materials. Chemical free.



Item #	Desc	UPC	Vendor	CS/UOS	Location
82170154	10.6"	016069006846	OWB-8	8/8	National

Rotating-Head Owl

This Natural Enemy Scarecrow® deters pests from your yard and gardens. With its realistic design, Gardeneer's Great Horned Owl is the perfect deterrent device. This chemical-free device safely deters birds and unwanted pests and protects your dock, deck or boat. The hand-painted life-like design makes it look realistic and attractive to use in any place that needs some pest control.



Item #	Desc	UPC	Vendor	CS/UOS	Location
82170158	18"	016069006921	RHO4-CJS	4/4	National

Inflatable Owl

Protect the fruit and vegetables in your garden from birds and other pests naturally using the Gardeneer Natural Enemy Inflatable Owl Scarecrows. These three, inflatable owls deter birds, rabbits, and chipmunks from visiting your garden in a safe, pesticide-free way. The bold brown, yellow, and black tones throughout each unit add realistic colors, and their intent gaze and upright ear tufts complete the effect.



Item #	Desc	UPC	Vendor	CS/UOS	Location
82170040	Shelf Display	016069000028	NE-OR	12/12	National

everguard REPELLENTS

Deer & Rabbit Repellent

Dual action formula. Dries odorless and clear. Deer, family & pet friendly. Long lasting! Up to 8 weeks! Spray any time on new growth. For use on bushes, flowers, shrubs, trees. Designed to be used year round. 100% Satisfaction guaranteed.



Item #	Desc	UPC	Vendor	CS/UOS	Location
81030040	32 oz. RTU	855289007000	ADPR032-6	6/6	East
81030003	32 oz. Concentrate	855289007024	ADPC032	6/6	East
81030002	1 gal. RTU	855289007017	ADPR128	4/4	National
81030029	5 lb Granular	855289007154	ADPG5D	4/4	East
81030028	2 lb Granular	855289007147	ADPG2D	6/6	East
81030027	32oz RTS	855289007123	ADPC32R	6/6	East

Tick & Mosquito Repellent

This product is environmentally friendly, has six key active ingredients and a spreader sticker for up to four weeks of efficacy without washing off. Safe to use around children & pets. Non-offensive odor. Use as a barrier repellent. Covers up to 10,000 sqft. (16oz covers up to 5,000 sqft.)



Item #	Desc	UPC	Vendor	CS/UOS	Location
81030015	32 oz. RTS	855289007079	ADPTM32R	6/6	National
81030016	32 oz. Concentrate	855289007086	ADPTM32C	6/6	East
81030019	16 oz. Concentrate	855289007109	ADPTM16R	6/6	National
81030030	2lb. Granular	855289007161	ADPG2T	6/6	East
81030031	5lb. Granular	855289007178	ADPG5T	4/4	East

Small Animal Repellent

Designed and used to repel mice, chipmunks, squirrels, skunks and other small mammals. Proven to be safe and extremely effective. Everguard Small Animal Repellent is a ready-to-use product. Simply shake bottle and spray your plants. Take back your yard and enjoy the beauty of flowering plants.



Item #	Desc	UPC	Vendor	CS/UOS	Location
81030041	32 oz. RTU	855289007055	ADPAR032-6	6/6	National
81030008	1 gal. RTU	855289007062	ADPAR128	4/4	East



Vole Scram™

Vole Scram is a new and unique natural repellent that drives out voles from your garden and lawn. Unlike other repellents, it works by taste and smell. It is easily applied and contains all organic ingredients. It won't harm people or animals and won't wash away with rain.



Item #	Desc	UPC	Vendor	CS/UOS	Location
80580027	6 lb.	186955000149	18006	6/6	National

Scram™ For Dogs Shaker Bag

Americas finest dog repellent works faster, is more effective and is less expensive per square foot. Provides strong, natural repelling power that trains dogs to stay away from these areas around your home without harming people, pets.



Item #	Desc	UPC	Vendor	CS/UOS	Location
80580019	3.5lb.	186955000743	14003	6/6	National

Scram™ For Cats Shaker Bag

Americas finest cat repellent works faster, is more effective and is less expensive per square foot than other cat repellents on the market. Provides strong, natural repelling power that trains dogs to stay away from these areas around your home without harming people, pets.



Item #	Desc	UPC	Vendor	CS/UOS	Location
80580021	3.5lb.	186955000842	15003	6/6	National

Mole Scram™

Mole Scram™ contains more active ingredients and a stronger formula than other repellents, yet it's organic and environmentally safe. The triple action formula works by taste and smell, and also reduces the presence of moles' insect food. Mole Scram™ rids your yard of moles and keeps them from returning.



Item #	Desc	UPC	Vendor	CS/UOS	Location
80580066	4.5 lb. Bag	186955000071	12040	6/6	National
80580011	10 lb Bag	186955000590	12010	4/4	National

Deer Scram™

All natural, biodegradable, environmentally safe and guaranteed to keep deer and rabbits away from your prized gardens, shrubs and trees, while not being offensive to humans. Deer Scram won't harm animals, the environment and, most importantly, you and your family. Blended from selected organic components, Deer Scram will keep deer off your plantings because it convinces deer that harm is nearby through their uncanny sense of smell.



Item #	Desc	UPC	Vendor	CS/UOS	Location
80580036	2 lb Bag	186955000040	1004	6/6	National
80580001	2.5 lb. Shaker	186955000033	1003	12/12	National
80580064	6lb. Bag	186955000026	10060	6/6	National
80580003	25 lb. Pail	186955000255	1025	48/1	National
80580070	32oz. RTU	186955000347	9001	12/12	National

All Natural Rabbit Scram™

Granular and easy to use, all natural and environmentally safe. Specifically formulated to stop rabbit damage to vegetables, shrubs and flowers, and it's guaranteed. It doesn't smell bad and won't wash off in rain. Rabbit Scram™ won't harm animals, the environment or you and your family.



Item #	Desc	UPC	Vendor	CS/UOS	Location
80580038	2 lb Bag	186955200446	11004	6/6	National
80580005	2.5 lb. Shaker	186955000439	11003	12/12	National
80580065	6 lb. Bag	186955000118	11060	6/6	National
80580071	32oz. RTU	186955000354	9002	12/12	National



Start & Grow Premium Plant Food 19-6-12

A premium slow released fertilizer designed for use at planting time as well as for use as a maintenance fertilizer to help maintain professional looking plants and landscapes.

Not for sale in AK, DE, HI, MD, MT, NV, VT, WA, VI, WI



Item #	Desc	UPC	Vendor	CS/UOS	Location
82280128	4 lb.	732221117457	11745	12/12	National

ferti-lome®

Yield Booster RTU

Helps stop blossom end rot on Tomatoes and setting of fruit and correcting calcium deficiencies. Contains 1.5% Calcium derived from Calcium Chloride. **Not for sale in HI, PR, VI, WI**



Item #	Desc	UPC	Vendor	CS/UOS	Location
82280027	32oz RTU	732221106055	10605	12/12	National

Tomato & Pepper Set RTU

Help blossoms set fruit, reduce end rot, and produce larger, meatier fruits. Active ingredient Cytokinin, as kinetin, based on biological activity. For use on tomatoes, beans, cucumbers, eggplants, melons, okra, peppers, strawberries, grapes. **Not for sale in AK, CA, HI, WI, PR, VI, WI**



Item #	Desc	UPC	Vendor	CS/UOS	Location
82280002	32oz RTU	732221100275	10027	12/12	National

Rooting Powder

Great for seeding or transplanting to stimulate early root formation and stronger root development. This root stimulator is easy to use. Simply dip the cutting into the powder before planting. **Not for sale in AK, HI, PR, VI, WI**



Item #	Desc	UPC	Vendor	CS/UOS	Location
82280037	2 oz	732221106390	10639	12/12	National

Spinosad

Controls worms and caterpillars. Provides excellent control of Colorado potato beetle, fire ants and thrips. Use on Vegetables, Fruits & Citrus to Kill Leafminers, Borers, Leaf Roller, Thrips, Worms (Caterpillars), Colorado Potato Beetles and other listed insects. Use on Lawns, Ornamental Trees, Shrubs & Flowers to Kill Armyworms, Sod Webworms, Cat Fleas, Loopers, Bagworms, Tent Caterpillars and other listed insects. **Not for sale in AK, HI, ME, PR, VI, WI**



Item #	Desc	UPC	Vendor	CS/UOS	Location
82280163	16 oz	732221160620	16062	12/12	National

Spinosad Soap

Use on vegetables, fruits, citrus, lawn and ornamentals. for control of foliage feeding worms, thrips and other listed pests. Provides control of spider mites, worms, fire ants and thrips.



Item #	Desc	UPC	Vendor	CS/UOS	Location
82280161	16oz Concentrate Not For Sale in AK, HI, ME, PR, VT, WI	732221160521	16052	12/12	National
82280162	32oz RTS Not For Sale in AK, CA, GA, HI, PR, VI, WI	732221160552	16055	12/12	National
82280165	32 oz RTS Not For Sale in AK, CA, GA, HI, PR, VI, WI	732221160644	16064	12/12	National
82280166	32 oz RTU	732221160767	16076	12/12	National

Copper Soap Fungicide

Helps control powdery mildew, black spot, rust and more. Use on roses, fruits and vegetables, ornamentals and turf. Perfect for the organic gardener.



Item #	Desc	UPC	Vendor	CS/UOS	Location
82280177	16oz Concentrate Not For Sale in AK, HI, ME, PR, VI, WI	732221161320	16132	12/12	National
82280178	32 oz RTS Not For Sale in AK, GA, HI, PR, VI, WI	732221161344	16134	12/12	National
82280179	32 oz RTU Not For Sale in AK, HI, ME, PR, VI, WI	732221161368	16136	12/12	National

Fungicide 5

Use on vegetables, fruits, nuts, trees, shrubs, lawns, flowering plants, houseplants, and tropicals. Bacillus amyloliquefaciens strain D747. **Not for sale in AK, HI, ME, PR, VI, WI**



Item #	Desc	UPC	Vendor	CS/UOS	Location
82280172	16oz Concentrate	732221161122	16112	12/12	National
82280173	32 oz RTS	732221161146	16114	12/12	National
82280174	32 oz RTU	732221161160	16116	12/12	National

Fruit Tree Spray

Fruit Tree Spray in an excellent organic option in containing the Spotted Lantern Fly. Kills eggs, larvae and adult insects. prevents fungal attack of plant tissues. use indoors or out. Can be used on fruits, nuts, vegetables, herbs, spices, roses, houseplants, flowers, shrubs and turfgrass. **Not for sale in AK, CA, HI, PR, VI, WI**



Item #	Desc	UPC	Vendor	CS/UOS	Location
82280006	16oz Concentrate	732221101319	10131	12/12	National

Triple Action

An effective insecticide, miticide and fungicide all in one provides plants with complete protection. Controls aphids, spider mites, scale, mealybug, whiteflies and more. Controls various fungal diseases including powdery mildew black spot, anthracnose, rust, and many others listed. Contains pyrethrins, and Neem. OMRI listed. **Not for sale in AK, HI, PR, VI, WI**



Item #	Desc	UPC	Vendor	CS/UOS	Location
82280142	8oz Concentrate	732221122444	12244	12/12	National
82280143	16oz Concentrate	732221122451	12245	12/12	National
82280144	32oz Concentrate	732221122468	12246	12/12	National
82280007	32 oz RTU Not For Sale in AK, CA, HI, PR, VI, WI	732221102514	10251	12/12	National
82280108	32 oz RTS Not For Sale in AK, HI, MD, PR, VI, WI	732221112476	11247	12/12	National

Tree & Shrub Drench

Control pests like aphids, leaf beetles, leafhoppers, borers, leafminers, mealybugs, japanese beetles, scale, thrip and whitefly. See label for complete list of pests controlled. Dissolves in water and moves down through soil, and is absorbed through the roots. Provides up to 12 months of systemic protection. Contains Imidacloprid. **Not for sale in AK, CA, CT, DE, HI, MD, MA, NJ, NY, VT, DC, PR, VI, WI**



Item #	Desc	UPC	Vendor	CS/UOS	Location
82280104	16oz Concentrate	732221112056	11205	12/12	National
82280105	32oz Concentrate	732221112063	11206	12/12	National
82280106	1gal Concentrate	732221112070	11207	4/4	National

Dipel Dust Biological Insecticide

Bacillus Thuringiensus Dipel Dust kills a number of crop destroying insects, such as bagworms, armyworms, tent caterpillar, and more. Can be used on vegetables, shrubs, lawns and flowers to kill insects biologically. **Not for sale in AK, CA, HI, PR, VI, WI**



Item #	Desc	UPC	Vendor	CS/UOS	Location
82280026	1lb Puffer	732221105867	10586	12/12	National
82280070	4 lb	732221108592	10859	12/12	National

Diatomaceous Earth

Diatomaceous Earth is a natural indoor and outdoor contact insecticide that works by causing abrasions on insects as they come in contact with product, resulting in loss of body fluids, then dehydration. Digestible by earthworms, thus causing them no harm. Very effective in controlling snails and slugs in bedding plant areas and around houses. **Not for sale in AK, DC, HI**



Item #	Desc	UPC	Vendor	CS/UOS	Location
82280390	4 lb.	732221402546	16004	4/4	National
82280391	7 oz.	732221402607	16005	12/12	National

Diatomaceous Earth Crawling Insect Control

Control crawling pests like ants, earwigs, snails, and slugs naturally. Diatomaceous earth causes abrasions on pests as they come in contact which results in loss of body fluids. Digestible by earthworms, thus causes no harm. **Not for sale in AK, HI, VA**



Item #	Desc	UPC	Vendor	CS/UOS	Location
82280152	7oz Puffer	732221160057	40260	12/12	National

Horticultural Oil

Use as a dormant and growing season insect spray. Kills all stages of insects, including eggs. Use to control insects, mites, scale, for roses, flowers, fruits, vegetables, houseplants and trees. Use on roses, flowers, fruits, vegetables, houseplants and trees. **Not for sale in AK, GA, HI, PR, VI, WI**



Item #	Desc	UPC	Vendor	CS/UOS	Location
82280159	16oz Concentrate	732221160422	16042	12/12	National

ferti-lome®

Caterpillar Killer Spray with BT

Non-toxic to humans, pets and beneficial insects. Use on vegetables, fruits, ornamentals and shade trees to control leaf chewing worms like tomato hornworm, gypsy moth, cabbage looper, tent caterpillar, imported cabbage worm, bagworms and others list on label. **Not for sale in AK, HI, ME, PR, VI, WI**



Item #	Desc	UPC	Vendor	CS/UOS	Location
82280153	8oz Concentrate	732221160118	16011	12/12	National
82280154	16oz Concentrate	732221160125	16012	12/12	National
82280155	32 oz RTU	732221160163	16016	12/12	National

Neem

3-in-1 Multi-Purpose Fungicide, Insecticide, Miticide. For organic gardening use on houseplants, fruits, flowers, trees, shrubs and other listed plants. Defend your plants and control diseases like powdery mildew, black spot, downy mildew, anthracnose, rust leaf spot, and others listed on label. Apply at the first sight of pests like aphids, spider mites, scale, whiteflies, beetles, and others listed. Can be used up to day of harvest. **Not for sale in AK, HI, ME, PR, VI, WI**



Item #	Desc	UPC	Vendor	CS/UOS	Location
82280167	16oz Concentrate	732221160927	16092	12/12	National
82280168	32 oz RTU	732221160965	16096	12/12	National

Come & Get It Products

For outdoor use around residential sites. Slug and bug control. Use around flowers, gardens, turf, and ornamentals. Lasts up to four weeks. **Not for sale in AK, HI, ME, NY, SD, PR, VI, WI**



Item #	Desc	UPC	Vendor	CS/UOS	Location
82280156	1 lb spinosad plus	732221160255	16025	12/12	National
82280158	1 lb slug & snail bait	732221160354	16035	12/12	National
82280157	3 lb slug & snail bait	732221160347	16034	12/12	National

Premium Lawn & Garden Sprayer

Strong metal pump rod. Broad base for increased stability.



Item #	Desc	UPC	Vendor	CS/UOS	Location
82280092	1gal Sprayer	732221109728	10972	1/1	National

Chameleon® Adaptable Hose End Sprayer

Chameleon Adaptable Hose End Sprayer is a versatile hose end sprayer. It includes 3 different spray positions. A quick connect adapter easily attaches to hoses. The sprayer can adapt to fit multiple container sizes. Handle design helps minimize contact with chemicals for a safer application method.



Item #	Desc	UPC	Vendor	CS/UOS	Location
82280093	32 oz	732221109797	10979	6/6	National

Brush Killer Stump Killer

For the control of unwanted woody plants, vines and broadleaf weeds around homes, cabins, fences, walkways, and other non-crop areas.

Not for sale in AK, HI, DC, PR, VI, WI



Item #	Desc	UPC	Vendor	CS/UOS	Location
82280121	8 oz Concentrate	732221114838	11483	12/12	National
82280122	16oz Concentrate	732221114845	11484	12/12	National
82280123	32oz Concentrate	732221114852	11485	12/12	National

MoleGo Granules

Repels moles and other small animals from your lawn, garden and flower bed. For year-round control apply mole repellent in early spring, mid summer & early fall. The mole remover can be used when planting new plants, trees and shrubs. Covers 5000 sq ft. ***CA**



Item #	Desc	UPC	Vendor	CS/UOS	Location
82280424	10 lb	732221133174	13317	4/4	West

2025

Hi-Yield®

Killzall 365

Control unwanted weeds for up to one year. Use on non-crop areas such as fencerows, driveways, around buildings for total vegetation control. 32oz concentrate treats up to 4,300 square feet. Contains 43% Glyphosate and 0.78% Imazapyr.

Not for sale in AK, HI, IA, NY, DC, PR, VI, WI



Item #	Desc	UPC	Vendor	CS/UOS	Location
82280251	32oz Concentrate	732221321700	32170	12/12	National
82280252	1gal Concentrate	732221321717	32171	4/4	National

Killzall Quick

Our fastest KILLZALL yet! Rainproof in 10 minutes, reaches roots in 1-2 hours; visible results in as little as 3 hours. A non-selective systemic weed and grass killer that will eliminate undesirable vegetation – roots and all – in and around lawns, driveways, parking areas, between stepping stones and bricks, flower beds, trees and shrubs. Special caution should be taken to avoid spraying desired vegetation. Contains Glyphosate 2% and Pelargonic Acid. **Not for sale in AK, CA, HI, PR, VI, WI**



Item #	Desc	UPC	Vendor	CS/UOS	Location
82280249	32oz RTU	732221321687	32168	12/12	National
82280250	1gal RTU	732221321694	32169	4/4	National

Killzall Super Concentrate Weed & Grass Killer

Super concentrate, Non-selective weed and grass killer contains a double surfactant formulation that dries on plants fast to start working quickly down to the root. Use near fences, on paths, patios, sidewalks, curbs, and driveways. Rainfast in 2 hours. **Not for sale in AK, HI, DC, PR, VI, WI**



Item #	Desc	UPC	Vendor	CS/UOS	Location
82280307	16oz Concentrate	732221336919	33691	12/12	National
82280308	32oz Concentrate	732221336926	33692	12/12	National
82280309	1gal Concentrate	732221336933	33693	4/4	National
82280389	2.5gal		33701	2/2	National
82280474	2.5gal *CA only	732221337077	33707	2/2	West

Spreader Sticker

A water soluble spray additive that makes water wetter and increases absorption, translocation and sticking of pesticides. Low foaming and contains no oil. **Not for sale in DC, HI, VT, WA, PR, VI, WI**



Item #	Desc	UPC	Vendor	CS/UOS	Location
82280199	8oz Concentrate	732221310612	31061	12/12	National
82280200	16oz Concentrate	732221310629	31062	12/12	National

55% Malathion Spray

Effectively controls aphids, thrips, spider mites, lace bugs and more. See label for full list. For use on herbaceous plants, ornamental non-flowering plants, shrubs, vegetables, and fruit trees. The active ingredient in this 16 oz. bottle of insecticide spray is 55% Malathion. **Not for sale in AK, CA, HI, MD, NY, DC, PR, VI, WI**



Item #	Desc	UPC	Vendor	CS/UOS	Location
82280218	8oz Concentrate	732221320277	32027	12/12	National
82280219	16oz Concentrate	732221320284	32028	12/12	National

Kill-A-Bug II Indoor/Outdoor Spray

Long-lasting action continues killing insects for up to four months after you spray. Use in and around residences and their immediate surroundings. **Not for sale in AK, HI, MD, MA, NJ, PR, VI, WI**



Item #	Desc	UPC	Vendor	CS/UOS	Location
82280266	32 oz RTU	732221323100	32310	12/12	National
82280265	1 gal RTU	732221323087	32308	4/4	National

Triclopyr Ester

Controls actively growing annual and perennial broadleaf weeds such as Oxalis and Wild Violet. Can be used on perennial bluegrass, perennial ryegrass, and tall fescue ornamental turf. Do not apply to Bahiagrass, Bentgrass, bermudagrass, Centipedegrass, St. Augustine, or Zoysiagrass. **Not for sale in AK, AZ, HI, PR, VI, WI**



Item #	Desc	UPC	Vendor	CS/UOS	Location
82280313	8oz Concentrate	732221352612	35261	12/12	National
82280314	16oz Concentrate	732221352629	35262	12/12	West

Hi-Yield®

Bug Blaster II Bifenthrin 2.4

Treats up to 5,300 sq. ft. odor free, non staining & water based provides up to 4 months control of cockroaches & 3 months control of other pests listed on label.



Item #	Desc	UPC	Vendor	CS/UOS	Location
82280274	16oz Concentrate Not For Sale in AK, DC, HI, MA, NE, NY, RP, VI, WI	732221323957	32395	12/12	National
82280473	32oz RTS Not For Sale in AK, HI, ME, PR, VI, WI	732221323974	32397	12/12	National

Stump Remover

This product decomposes the wood of tree stumps allowing for easy removal or burning. This tree stump remover is harmless to vegetation surrounding the stump. **Not for sale in PR, VI, WI**



Item #	Desc	UPC	Vendor	CS/UOS	Location
82280215	1.5 lb	732221320154	32015	12/12	National

Fire Ant Control with Acephate

A granule insecticide for control of fire ants. Contains the active ingredient Acephate. Designed for use on residential, recreational turfgrass, commercial turf as well as non-crop areas. This fire ant control solution controls fire ants for a full season for long lasting protection. **Not for sale in AK, CA, CO, CT, DE, HI, IL, IN, IA, KY, ME, MD, MA, MN, MO, MT, NE, NH, NJ, NY, ND, OH, OR, PA, RI, SD, UT, VT, WA, WV, WI, WY, DC, PR, VI, WI**



Item #	Desc	UPC	Vendor	CS/UOS	Location
82280283	8oz	732221330337	33033	12/12	National
82280284	1lb	732221330351	33035	12/12	National

Systemic Insect Granules

Controls aphids, whiteflies, leafminers, lace bugs and more. Ideal for roses, flowers, shrubs and containerized plants both indoor and outdoor. The insecticide granules provide protection against damaging insects for up to 2 months. Active ingredient: Imidacloprid **Not for sale in AK, CT, HI, MD, MA, NJ, NY, RI, VT, DC, GA, PR, VI, WI**



Item #	Desc	UPC	Vendor	CS/UOS	Location
82280207	1 lb	732221321885	31228	12/12	National

Herbicide Granules

These easy-to-apply granules are for use in flowerbeds, vegetable gardens, around ornamental trees, shrubs, and flowers listed on the label. **Not for sale in AK, HI, NM, PR, VI, WI**



Item #	Desc	UPC	Vendor	CS/UOS	Location
82280192	4 lb	732221227422	22742	10/10	National
82280191	15lb	732221217485	21748	1/1	National

Turf & Ornamental Weed & Grass Stopper

Provides superior control of Crabgrass and many other annual grass and broadleaf weeds. See label. Intended for use on ornamental landscape areas, established lawns and ornamental turf. **Not for sale in AK, HI, MA**



Item #	Desc	UPC	Vendor	CS/UOS	Location
82280282	35 lb	732221330313	33031	1/1	National

Slug & Snail Bait

A very effective and easy to use Slug and Snail control. Formulated to attract slugs and snails, then paralyze them until the sun dehydrates them and they die. Longer lasting all weather formula effective up to 3 to 4 weeks. **Not for sale in AK, CA, HI, MA, NJ, NY, PR, VI, WI, WY**



Item #	Desc	UPC	Vendor	CS/UOS	Location
82280229	2.5 lb	732221320703	32070	12/12	National

Dusting Wettable Sulfur

Can be used as a dust or wettable spray on Roses, shrubs, flowers, fruits and vegetables. Provides a versatile method of controlling listed insects and diseases. As a spray: 4 tablespoons per gallon. As a dust: Apply on all plant surfaces to thoroughly cover. **Not for sale in AK, HI, MA, NJ, ND, DC, MN, PR, VI, VT, WI**



Item #	Desc	UPC	Vendor	CS/UOS	Location
82280257	3.25 lb	732221321885	32188	12/12	National

Hi-Yield®

Vegetable & Ornamental Insect Control Granules

Designed as a ready-to-use granular insecticide to control various insects and spiders on home perimeter, ornamental & flower gardens. Active ingredient: Bifenthrin
Not for sale in AK, HI, MA, OK, WI, PR, VI



Item #	Desc	UPC	Vendor	CS/UOS	Location
82280269	4 lb	732221323254	32325	12/12	National

Measuring Cup

These 4 oz plastic cups are calibrated for Teaspoon, tablespoon and ounces to provide a handy reusable measuring device. Do not use for food products.



Item #	Desc	UPC	Vendor	CS/UOS	Location
82280094	1 cup	732221110083	11008	36/36	National

2, 4-D Amine A Selective Weed Killer

Provides control of many emerged annual and perennial broadleaf weeds. Labeled for selected farm crops, ornamental turf, brush control, forest management and aquatic applications. Active Ingredient: Dimethylamine Salt of 2,4-Dichlorophenoxyacetic Acid* 47.2% *Isomer Specific AOAC Method, Equivalent to 2,4-Dichlorophenoxyacetic Acid 39.2%, 3.8 lbs./gal. **Not for sale in AK, DC, HI, IA, MA, ME, MN, NH, NM, NY, PR, RI, VI, VT, WA, WI**



Item #	Desc	UPC	Vendor	CS/UOS	Location
82280293	32oz	732221332546	33254	12/12	West

GreenGro® Biologicals

Insect & Pest Spray

Want to give your plants a defensive barrier of protection against common insects? GreenGro Insect & Pest Spray is the ultimate repellent to keep ants, fleas, flies, aphids, spiders and more off your plants. Unlike harsh chemical pesticides, our formula uses quality organic ingredients that prevent pests from ever considering your plants a target. Spray onto plants every couple of weeks for pest prevention, or up to three times per week to fight an infestation. This formula is safe for use around humans and pets, all natural and non-toxic.



Item #	Desc	UPC	Vendor	CS/UOS	Location
82850060	16 oz RTU	860007440090	IPS-16	12/12	West

GONZO®

Dead-End® Mole & Gopher Trap

Your easy, no-mess way to stop moles & gophers dead in their tracks and keep them from destroying your lawn and property effectively and safely without poisons.



Item #	Desc	UPC	Vendor	CS/UOS	Location
82320002	Dead-End Trap	855846004015	5001	12/12	West

Mole & Gopher Sonic Spike II Repellers

New and improved sonic spike repeller twin pack uses a microprocessor, eliminating analog parts that are prone to failure. Insert spikes close to your structure and gradually move spikes towards the perimeter of your yard.



Item #	Desc	UPC	Vendor	CS/UOS	Location
82320017	Sonic Repellers	855846004176	5016	6/6	National

Rodent Pro Mouse Trap

GONZO® ProSeries™ Multi-Max® Snap Traps are great for trapping mice or rats. This versatile trap can be used anywhere, inside the house, barn, shed or outside for rodents of all sizes. Patented 90° vertical trigger strikes faster than traditional traps and the unique design draws rodents deep into kill zone.



Item #	Desc	UPC	Vendor	CS/UOS	Location
82320039	2 pk	855846004299	7000	12/12	National

Rodent Pro Sure-Strike Trap

GONZO® RodentPro® Superior® Sure-Strike® traps are a marked improvement from the traditional wood traps. Stainless steel mechanisms won't rust, keeping the trap dependable year after year. This versatile trap can be used anywhere, inside the house, barn, shed or outside. Super powerful springs ensure a quick, humane kill. Four-Way® mechanism kills mice and rats approaching the trap from any direction.



Item #	Desc	UPC	Vendor	CS/UOS	Location
82320057	2 pk Mouse	855846084596	7013	36/36	National
82320058	Single pk Rat	855846004602	7014	12/12	National

GONZO

SAFEHAVEN TRAPS

GONZO® Safe Haven™ live catch animal traps are constructed of heavy gauge, galvanized steel and set up in minutes. Keep unwanted animals from your grounds and humanely move them to a new location. No poisons or needless kills.



Small Animal Trap

The humane catch and release safe haven small animal trap. Great for squirrels, chipmunks, feral cats, rabbits, and other small nuisance animals.

Item #	Desc	UPC	Vendor	CS/UOS	Location
82320051	Small Safehaven	855846004534	8000	10/10	National

Large Animal Trap

The humane catch and release safe haven Large animal trap. Great for raccoons, opossums, skunks, ground hogs and other large nuisance animals.



Item #	Desc	UPC	Vendor	CS/UOS	Location
82320052	Large Safehaven	855846004541	8001	5/5	National

Safe Haven Large Trap with BONUS Small Trap

GONZO® Safe Haven™ live catch animal traps are constructed of heavy gauge, galvanized steel and set up in minutes. Keep unwanted animals from your grounds and humanely move them to a new location. Large trap for raccoons, opossum, and skunks. Small trap for squirrels, rabbits, and chipmunks.



Item #	Desc	UPC	Vendor	CS/UOS	Location
82320053	BONUS Safehaven	855846004558	8002BP	3/3	National

Ground Squirrel Max Trap

The humane catch and release Safehaven Squirrel Max Trap, traps multiple squirrels at once.



Item #	Desc	UPC	Vendor	CS/UOS	Location
82320054	Safehaven SquirrelMax	855846004565	8003	1/1	National

Safe Haven Chipmunk Max Trap

Just bait and set along walls or known pathways. This versatile trap can be used anywhere, inside the house, barn, shed or outside. Keep unwanted animals from your grounds and humanely move them to a new location.



Item #	Desc	UPC	Vendor	CS/UOS	Location
82320060	Chipmunk Trap	855846004626	8005	5/5	National

Rodent Safe Haven Trap

Just bait and set along walls or known pathways. This versatile trap can be used anywhere, inside the house, barn, shed or outside. Keep unwanted animals from your grounds and humanely move them to a new location.



Item #	Desc	UPC	Vendor	CS/UOS	Location
82320059	Rodent Trap	855846004619	8004	6/6	National

Safe Haven Rat Max Trap

Just bait and set along walls or known pathways. This versatile trap can be used anywhere, inside the house, barn, shed or outside. Keep unwanted animals from your grounds and humanely move them to a new location.



Item #	Desc	UPC	Vendor	CS/UOS	Location
82320061	Rat Max Trap	855846004633	8006	4/4	National

Rodent Pro Safe Haven Mouse Trap

This versatile trap can be used anywhere, inside the house, barn, shed or outside. Humanely catch and release without ever having to touch the mice.



Item #	Desc	UPC	Vendor	CS/UOS	Location
82320046	2 pk	855846004428	7006	6/6	National



Mole Trap

Simply the best way to kill moles. Easy to place and set. All steel construction with powder coat finish provides long life.



Item #	Desc	UPC	Vendor	CS/UOS	Location
82320003	Mole Trap	855846004022	5002	6/6	National

Gripper Mole Trap

Gripper Mole Trap provides an effective means to control moles. Find an active tunnel, set the trap, and say goodbye to moles.



Item #	Desc	UPC	Vendor	CS/UOS	Location
82320013	Mole Trap	855846004138	5012	12/1	West

Jaw Claw Mole Trap

Zinc plated steel construction with easy to read instructions. No bait required - easy to set! Works from both directions. Safe & effective, making this product Green approved for organic gardening!

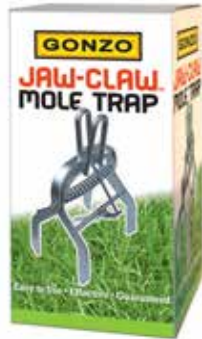

Item #	Desc	UPC	Vendor	CS/UOS	Location
82320012	Mole Trap	855846004121	5011	6/1	West

Wire Gopher Trap

Kills Moles & Gophers effectively and safely without poisons. Features durable steel construction with powder coat finish for long-lasting use.



Item #	Desc	UPC	Vendor	CS/UOS	Location
82320001	2-pack (Retail packaging)	855846004008	5000	12/12	West
82320010	Bulk	855846004107	5000B	24/24	West
82320030	Bulk-Stainless Steel	855846004336	5000BSS	24/1	West

Gopher Shield

Prevents moles, gophers and voles from destroying new plantings. Stainless steel weave creates long-lasting protection. Expands for new growth. Promotes healthy root growth year round.



Item #	Desc	UPC	Vendor	CS/UOS	Location
82320026	4" Bulk 100ct	855846004251	5025	1/1	West
82320007	1 gal	855846004077	5007	6/6	West
82320027	1gal 100ct	855846004268	5026	1/1	West
82320008	5 gal	855846004084	5008	12/12	West
82320028	5 gal 50ct	855846004275	5027	1/1	West
82320009	15 gal	855846004091	5009	6/6	West
82320029	15 gal 50ct	855846004282	5028	1/1	West

Copper Stopper™ Slug & Snail Barrier Tape

Slugs and snails are deterred from crossing GONZO® Copper Stopper™ Barrier Tape as their slime secretions react with the copper surface providing them with an unpleasant sensation.

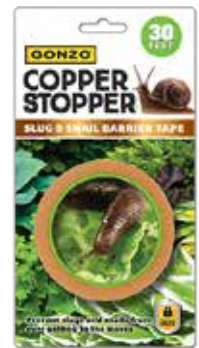

Item #	Desc	UPC	Vendor	CS/UOS	Location
82320055	Slug & Snail Tape	855846004527	9000	12/12	West



HARRIS

★ Since 1922 ★

Wooden Trap

Classic style wooden traps offer reliable construction, quick and easy trapping, and is a very cost-effective way to rid your home of mice and rats



Item #	Desc	UPC	Vendor	CS/UOS	Location
82770103	1 Pack Rat Trap	072725002317	WRT-1	24/24	West
82770101	2 Pack Mouse Trap	072725002300	WMT-2	36/36	West



Glue Trap

The Trap opens like a book to double in size. Trap can lay flat or can be placed L shaped against a wall.

Item #	Desc	UPC	Vendor	CS/UOS	Location
82770050	2 Pack Rat Trap	072725000269	HRG-2	12/12	West
82770010	1 Pack Rat & Mouse Super Size	072725002423	BLKRAT-1	24/24	West
82770011	2 Pack Rat Plastic Trap	072725004106	BLK-RG2	24/24	West
82770045	2 Pack Mouse Trap	072725000641	HMG-2	24/24	West
82770046	4 Pack Mouse Trap	072725000252	HMG-4	24/24	West
82770032	5 Pack Glue Board Mouse & Insect	072725001310	GB-5	18/18	West

Reusable Plastic Rat Trap

Reusable Plastic Rat Traps kills rats. Traps are easy to use, just bait and press to set. They are durable, reusable and work the first time. The traps are powerful, effective and contain no chemicals.



Item #	Desc	UPC	Vendor	CS/UOS	Location
82770077	Reusable	072725002331	PRT-1	12/12	West

Snake Glue Trap

This extra-large trap, measuring an impressive 7.5 inches by 10 inches, is meticulously designed to capture nuisance rodents with ease. Its superior efficacy makes it an ideal choice for both indoor and outdoor settings, ensuring that your spaces remain free from unwanted pests. Each pack contains one sticky trap, making it a convenient and essential tool for pest control in homes, gardens, and commercial spaces.



Item #	Desc	UPC	Vendor	CS/UOS	Location
82770089	1 Pack	072725004328	SNAKE-1	15/15	West

Roach Gel

Roach Killing Gel (60g) is an easy to use solution for killing a large variety of roaches in a variety of settings both indoor and out. Use indoors in kitchens, bathrooms, basements, garages and laundry rooms as a crack and crevice, spot treatment or bait station application. Apply to areas frequented by roaches such as openings leading to voids and hollow spaces in floors, walls, ceilings, equipment legs and bases, around plumbing pipes doors and windows and behind and under appliances and cabinets where cockroaches hide. Use outdoors as a spot, thin bead or bait station application at pest entry sites such as along windows and doors. Always read and follow label instructions.



Item #	Desc	UPC	Vendor	CS/UOS	Location
82770080	60 grams	072725009774	RGEL-60	12/12	West

99% Boric Acid Powder

Boric Acid works by interfering with the roach's digestive system. In addition, the powder will cling to the outside of the roach, helping to kill other roaches when the affected roach returns to the colony. The powder is fast acting; insects coming into contact with the boric acid will die within 72 hours.



Item #	Desc	UPC	Vendor	CS/UOS	Location
82770002	16oz	072725001600	BAR-16	12/12	West
82770051	16oz squeeze bottle	072725000054	HRP-16	12/12	West

Famous Roach Tablets

Famous Roach Tablets has been killing roaches since 1922! Kills roaches, waterbugs & silverfish. Just place tablets in out-of-the-way areas where roaches travel and roaches will find them. One box can treat an entire house, making it one of the most efficient and cost-effective ways to kill a roach. For use in residential and commercial applications.



Item #	Desc	UPC	Vendor	CS/UOS	Location
82770054	6oz Roach Tablets	072725000030	HRT-6	12/12	West



47% Vinegar

MIL-X 47% Vinegar does not contain fillers or dyes. With 9X the power of standard vinegar, MIL-X Vinegar can be used at full strength or diluted depending on the application. It can be used to clean patios and driveways, eliminate odors from laundry and so much more.



Item #	Desc	UPC	Vendor	CS/UOS	Location
82770112	1 gal Concentrate	072725013306	MILX47-128	4/4	National

30% Vinegar

The 30% vinegar solution can clean patios & driveways, eliminate odors from laundry, and much more. It contains absolutely no dyes, bleach, chemicals or ammonia. This pure vinegar formula is 6x more powerful than standard vinegar and can be used diluted with up to 7 parts of water. Concentrated vinegar is widely used to replace many harmful and expensive commercial cleaning products.



Item #	Desc	UPC	Vendor	CS/UOS	Location
82770097	32oz	072725007688	VINE30-32	12/12	National
82770096	1gal Concentrate	072725005516	VINE30-128	4/4	National

12% Hydrogen Peroxide

Harris Hydrogen Peroxide is recognized as one of the cleanest and most versatile of all chemicals. Its strong oxidizing properties make it a powerful bleaching agent, stain remover, and multi-purpose cleaner when used as directed.



Item #	Desc	UPC	Vendor	CS/UOS	Location
82770108	1gal Concentrate	072725014143	HP12-128	4/4	National

20% Vinegar Weed Killer

Vinegar Weed Killer is organic and fast-acting. It provides non-selective control of herbaceous broadleaf weeds and weed grasses. Spray this product on unwanted weeds (vegetation) to the point of wetness. Adjustable trigger sprayer included for easy application.



Item #	Desc	UPC	Vendor	CS/UOS	Location
82770099	32oz RTU	072725007824	WWEED-32	12/12	National
82770098	1gal w/ trigger sprayer	072725007817	WWEED-128	4/4	National

Spotted Lanternfly Killer

Spotted Lanternfly 1 Gallon with Trigger Sprayer kills Spotted Lantern Flies and other insects after the spray dries. This water-based formula is long lasting when kept dry outdoors but will need additional applications after heavy rain. Spotted Lantern Flies like to harbor over during winter months and can become a nuisance pest. Recommended applications may be both indoor and outdoors. Always follow label directions and keep out of reach of children.



Item #	Desc	UPC	Vendor	CS/UOS	Location
82770087	1gal w/ trigger sprayer	072725012156	SLF-128	4/4	East

Home Pest Control

Non-staining formula kills German cockroaches, spiders, ants, stink bugs, kudzu bugs, fleas, mosquitoes, scorpions, fleas and silverfish for up to 12 months. Contains the active ingredient like Deltamethrin.



Item #	Desc	UPC	Vendor	CS/UOS	Location
82770048	1gal w/ trigger sprayer	072725000320	HPC-128	4/4	West

Potted Plant Insect Traps

Harris Potted Plant Insect Traps trap a wide variety of insects that attack indoor plants. The traps hold gnats, whiteflies, aphids, and many others, without using insecticides. Do not use traps in wet areas. In case of accidental contact with the adhesive, use baby oil or cooking oil for cleanup. Dispose of when traps are full or after 3 months.



Item #	Desc	UPC	Vendor	CS/UOS	Location
82770073	30 Traps / 7 Stakes	072725003178	PLANT-7	12/12	National

Neem Oil

Neem Oil is 100% cold pressed & unrefined with absolutely no chemicals or additives included to ensure that the neem oil retains its original composition. The 100% cold pressed neem oil is EPA registered to control aphids, whiteflies, mealy bugs, foliar fungus (mildew), and more. Use Harris Neem Oil on a variety of flowering and potted plants, vegetable gardens, lawn, ornamentals, fruit trees and more.



Item #	Desc	UPC	Vendor	CS/UOS	Location
82770064	12oz Concentrate	072725006711	NEEM-12	12/12	National
82770065	32oz Concentrate	072725011821	NEEM-32	12/12	National

Powder Duster

The Harris Powder Duster is easily loadable and a great way to efficiently spread a light dusting of fine powder applications. Can be used indoors or outdoors.



Item #	Desc	UPC	Vendor	CS/UOS	Location
82770072	Powder Duster	072725002355	PD-1	12/12	National

Food Grade Diatomaceous Earth

Diatomaceous Earth works by piercing the exoskeleton of insects. The diatoms, or phytoplankton, that make up DE have tiny, strong shells made of silica, one of the hardest natural substances on Earth. The sharp edges of the silica cause hundreds of abrasions on insects with exoskeletons, causing irreparable damage. Once the insects' exoskeletons are pierced, they dry out and pass away.



Item #	Desc	UPC	Vendor	CS/UOS	Location
82770025	8oz Puffer	072725002706	EDE-FG8	12/12	National
82770019	2lb with Duster	072725004076	DE-FG2P	12/12	National
82770021	4lb with Duster	072725004083	DE-FG4P	8/8	National
82770018	10.5lb with Duster	072725004182	DE-FG105P	3/3	West

Diatomaceous Earth Crawling Insect Killer

Harris Diatomaceous Earth Crawling Insect Killer uses diatomaceous earth to kill roaches, fleas, ants, bed bugs, and more. 8oz size comes in a puffer bottle for easy surface application or deep into cracks and crevices. No fillers or additives, only 100% freshwater diatomaceous earth that will remain effective as long as it's kept dry.



Item #	Desc	UPC	Vendor	CS/UOS	Location
82770017	8oz Puffer	072725006360	DECRAWL-8	12/12	National
82770016	64oz	072725006377	DECRAWL-64	8/8	National

Total Release Fogger

Total Release Foggers are for use in greenhouses, fruit and vegetable storage areas, and indoor gardening areas. Used for controlling fungus gnats, spider mites, two-spotted spider mites, aphids, whiteflies, scale, mealy bugs, and thrips. No residuals.



Item #	Desc	UPC	Vendor	CS/UOS	Location
80880245	5.5oz	628683446061	DDTRF5.5OZ	12/12	West

Spider Mite Knockout

Spider Mite Knockout has a high concentration of the naturally-occurring insecticide pyrethrin, used to control aphids, spider mites, whiteflies, leafhoppers, Japanese beetles, and more. Can be used indoors and out; safe to apply on food crops up to one day before harvest.



Item #	Desc	UPC	Vendor	CS/UOS	Location
80880244	16oz	628683115059	DDSMK16OZ	12/12	West

Dual-Outlet Analog Timer

Using an analog timer to automate your lighting adds convenience and encourages productive growth with consistent hours of light. Timers are also essential for many hydroponic system applications.



Item #	Desc	UPC	Vendor	CS/UOS	Location
80880235	1875W	638104627504	TM01015D	12/12	West

7 Day Dual Outlet Digital Timer

Using the Hydrofarm Autopilot TM01715D* 7 Day Dual Outlet Digital Timer to automate your lighting adds convenience and encourages productive growth with consistent hours of light. The Hydrofarm TM01715D 7 Day Dual Outlet Digital Timer is essential for all hydroponic system applications.



Item #	Desc	UPC	Vendor	CS/UOS	Location
80880241	Digital Timer	638104627528	TM01715D	12/12	West



Corn Gluten Weed Preventer plus Lawn Food

Corn Gluten Weed Preventer plus Lawn Food feeds the lawn while preventing crabgrass, dandelions, and over 25 other broadleaf and grassy weeds. For optimal results, apply early in the spring—between March and early May—before weeds germinate. For a weed-free organic lawn year round, apply corn gluten meal in early and late spring and again in early and late fall.



Item #	Desc	UPC	Vendor	CS/UOS	Location
81430185	5M	079545225883	11591	1/1	West



Soil pH/Moisture Tester

Mini pH and moisture tester prevents over watering and checks which plants suit your soil with one test. Two stainless steel probes offer different readings. Instantly tells you when to water your plants. Tests the acidity and alkalinity of soil. Includes watering needs for over 100 plants. Includes pH preferences for over 50 fruits, vegetables and flowers. No batteries required for operation.



Item #	Desc	UPC	Vendor	CS/UOS	Location
80140214	Tester	035307018175	1817-6	6/6	National

Soil Test Kit

The Soil Test Kit from Environmental Concepts is a liquid based testing kit which is great for hobbyists, classrooms and professionals. It contains all components needed for a total of 40 tests. 10 each for soil pH, Nitrogen, Phosphorus and Potash. Detailed instructions are included along with extensive guidelines for altering soil and using the best plants for your soil environment.



Item #	Desc	UPC	Vendor	CS/UOS	Location
80140211	40 Tests	097395216628	1662	6/6	National



Squirrel Stopper

Liquid products that stops indoor and outdoor foraging, nesting and entry damage caused by squirrels and chipmunks.



Item #	Desc	UPC	Vendor	CS/UOS	Location
81490088	32oz RTU	813935000065	SQ-U-016	6/6	West

Animal Stopper Pet Safe Repellent

Animal Stopper can be used to deter deer, rabbits, groundhogs and most other common pests from low level foraging. It stops deer, rabbits, groundhogs, skunks and most common garden pests!



Item #	Desc	UPC	Vendor	CS/UOS	Location
81490045	32oz RTU	813935003004	AS-U-016	6/6	West

Dog & Cat Stopper

Liquid and granular products that stop indoor and outdoor damage caused by most dog and cat breeds without causing pain or harm to them.



Item #	Desc	UPC	Vendor	CS/UOS	Location
81490095	32oz RTU	813935003028	WW-U-016	6/6	West

Deer Stopper

Ready-to-use and concentrate products that stop damage caused by deer, moose, elk and related animals.



Item #	Desc	UPC	Vendor	CS/UOS	Location
81490058	1 quart	813935000256	DS-C-032	6/6	West
81490052	32oz RTU	813935000034	DS-U-016	6/6	West



Weed & Grass Killer

Pulverize Weed & Grass Killer is an effective solution designed to tackle a wide range of vegetation, including weeds, grass, algae, and moss. Ideal for use on gravel, gardens, and concrete, this product ensures a clear area without the risk of staining surfaces.



Item #	Desc	UPC	Vendor	CS/UOS	Location
81490159	32oz RTU	813935009525	PWG-U-032	6/6	West

Take Down Garden Spray

Will kill exposed aphids, beetles (colorado potato beetle, flea beetle, Japanese beetle, asparagus beetle), caterpillars (gypsy moth caterpillars, tent caterpillar, diamondback moth larvae, leafrollers), ants (except fire ants, harvester ants, carpenter ants, and pharaoh ants), mealybugs, mites, leafhoppers, scale, thrips, fungus gnats, whitefly, adelgids, plant bugs, sawfly larvae, psyllids, spittlebugs, and phylloxera. Dormant and growing season insect spray that kills all accessible stages of listed insects, including eggs. Does not persist in the environment. Contains: Pyrethrins and Canola Oil.



Not for sale in DC, ND, WY

Item #	Desc	UPC	Vendor	CS/UOS	Location
80820091	32 oz. RTU	022179103634	LG 6232	12/12	National
80820317	1pt. Conc.	022179101302	LG 6239	6/6	National
80820286	1gal Concentrate	022179104419	LG 6247	4/4	West

2025



Insecticidal Soap RTU

Contains specially selected soaps (fatty acid salts) chosen for effective pest control. This product provides curative control of powdery mildew. **Not for sale in AK, HI, ME, MT, ND, SC, WY, DC, SD**



Item #	Desc	UPC	Vendor	CS/UOS	Location
80820390	32 oz. RTU	022179105485	LG 6412	12/12	National

Take Down -O

Concentrated version of Take Down Garden Spray. **For Sale Only AL, CA, OR**



Item #	Desc	UPC	Vendor	CS/UOS	Location
80820388	1 pt. Take Down-O	022179105553	LG 6244	6/6	West
80820389	1 gal. Take Down-O	022179105560	LG 6249	4/4	West

Garden Insect Spray

For control of foliage feeding worms (caterpillars), thrips, fire ants and other listed pests in: lawns, outdoor ornamentals, vegetables, apples, citrus and stone fruit. Contains the active Spinosad.



Item #	Desc	UPC	Vendor	CS/UOS	Location
80820224	8 oz. Concentrate	022179104730	LG 6158	12/12	National
80820070	16 oz. Concentrate	022179101630	LG 6150	12/12	National
80820073	16 oz. RTS	022179102439	LG 6130	12/12	National
80820071	32 oz. Concentrate	022179102446	LG 6135	12/12	National
80820223	32 oz. RTU	022179104341	LG 6133	12/12	National
80820074	32 oz. RTS	022179102958	LG 6138	12/12	National
80820072	1 gal. Concentrate	022179102392	LG 6155	4/4	West



Take-Out™ Complete Insect Control

Controls over 450 insects including mosquitoes, chinch bugs, fleas, aphids, fire ants, mites, and more. Can be used on vegetables, as well as ornamental trees, shrubs, and flowers. Works quickly, with results within 24 hours

Item #	Desc	UPC	Vendor	CS/UOS	Location
80820404	1pt.	022179106062	LG 6416	12/12	National
80820405	1qt.	022179106079	LG 6418	12/12	National
80820406	32 oz. RTS	022179106086	LG 6420	12/12	National
80820407	32 oz. RTU	022179106093	LG 6430	12/12	National



Sluggo®

Snail and slug control at its best. An alternative to traditional slug and snail baits, Sluggo contains iron phosphate and can be used around pets and wildlife. This product is labeled for use in vegetable gardens up until harvest and remains effective after rain or sprinkling. A pellet that breaks down into fertilizer! New lower rate, 1 lb. covers up to 2,000 sq ft.



Item #	Desc	UPC	Vendor	CS/UOS	Location
80820094	1 lb. Shaker	022179101241	LG 6515	12/12	National
80820095	2.5 lb. Jug	022179101852	LG 6500	6/6	National
80820372	2.5 lb. Display	022179101852	LG 10032	80/80	West
80820096	5 lb. Jug	022179101579	LG 6530	6/6	National
80820097	10 lb. bag	022179101203	LG 6510	1/1	National
80820098	10 lb. Jug	022179101869	LG 6555	6/6	National

Sluggo® Plus

This new formulation of Sluggo controls slugs, snails, earwigs, sow bugs, pill bugs (roly poly) and cut worms too. Sluggo Plus is a smaller light green pellet and can be used on ornamentals, vegetables, fruit trees, berries, turf and in non-commercial greenhouses. Scatter the bait at ½ to 1 lb. per 1,000 sq ft around and near the plants to be protected. Contains the active Spinosad and iron phosphate.



Item #	Desc	UPC	Vendor	CS/UOS	Location
80820101	1 lb. Shaker	022179102484	LG 6575	12/12	National
80820102	2.5 lb Jug	022179102460	LG 6570	6/6	National
80820373	2.5 lb. Display	022179102460	LG 10081	80/80	West
80820103	5 lb. Jug	022179102583	LG 6580	6/6	National
80820104	10 lb. Jug	022179102590	LG 6585	6/6	National

Sluggo® Maxx

Controls snails and slugs and can be used around pets and wildlife. This product contains a higher concentration of iron phosphate than Sluggo® or Sluggo® Plus. 3x more power in each pellet! 1 lb. covers 11,000 sq. ft.

Not for sale in DE, MI, ND, OH, OK, SC, TN, WY, KS



Item #	Desc	UPC	Vendor	CS/UOS	Location
80820352	1lb Can	022179105201	LG 6542	6/6	National
80820353	2.5 lb Jug	022179105195	LG 6544	6/6	National

Bug Buster-O Insect Control

This organic insecticide controls over 100 insects. A natural pyrethrin, it quickly knocks down and kills cucumber beetles, Japanese beetles, stink bugs, tomato hornworms and many more insects. It can be used on fruits, vegetables and ornamentals - even on the day of harvest. Easy-to-use. **Not for sale in AZ, AR, ID, IA, KY, NE, NV, ND, WV, WY**



Item #	Desc	UPC	Vendor	CS/UOS	Location
80820191	8oz. Concentrate	022179104211	LG 6398	6/6	National
80820192	1pt. Concentrate	022179104228	LG 6396	6/6	West

Nematode Control

Nematode Control for home vegetable gardens, lawns, vineyards, fruit trees and ornamentals. It can be used up to the day of harvest. OMRI listed. Nematode Control Concentrate contains a natural ingredient that comes from the bark of a South American tree called Quilloja. Can be used as a pre-planting treatment or on established plants including berries, leafy greens, tomatoes, bulb, root and tubers. **Not for sale in AK, DE, ID, IL, KS, ME, MA, MI, MN, NE, NV, NH, NJ, NY, ND, OH, SD, UT, VT, WV, WY, DC**



Item #	Desc	UPC	Vendor	CS/UOS	Location
80820129	1qt Concentrate	022179103955	LG 6356	6/6	West

All Natural Snail & Slug Spray

Made from 100% naturally occurring plant materials. Repels snails and slugs on fruits, vegetables, citrus, and ornamentals. Excellent choice for preventative control! Can be used up to the day of harvest. **Not for sale in AK, AL, AR, CO, CT, DC, GA, IA, ID, IN, KS, KY, LA, MD, ME, MI, MO, MS, MT, NC, ND, NM, NV, SC, SD, TN, UT, VA, VT, WV, WY, OH, OK, RI**



Item #	Desc	UPC	Vendor	CS/UOS	Location
80820093	1 qt RTU	022179102903	LG 6440	12/12	National

All Natural Mite & Insect Control

Made from 100% naturally occurring materials. Controls mites and insects on vegetables, grapes, fruit and nut trees, and ornamentals. Provides broad spectrum control, rapid knockdown, and residual control. Can be applied to crops any time during the growing season up to the day of harvest. **Not for sale in AK, AL, AR, AZ, CO, CT, DC, GA, IA, ID, IN, KS, KY, LA, MD, ME, MI, MO, MS, MT, ND, NH, NM, NV, OH, OK, PA, RI, SC, SD, TN, VA, VT, WA, WI, WV, WY**



Item #	Desc	UPC	Vendor	CS/UOS	Location
80820055	1qt RTU	022179102781	LG 6284	12/12	National



Monterey B.t.

Kills caterpillar-type insects, but has no effect on birds, earthworms, or beneficial insects such as honeybees and ladybugs, when used as directed. Worm stage and caterpillars eat treated foliage, then immediately stop feeding and damaging plants. For use on fruits, vegetables, ornamentals and shade trees. Can be used on edible plants up to the day of harvest. Contains BT Kurstaki bacteria. **RTU Not for sale in ND, WY**



Item #	Desc	UPC	Vendor	CS/UOS	Location
80820225	8oz Concentrate	022179104747	LG 6328	12/12	National
80820066	16oz Concentrate	022179103900	LG 6332	12/12	National
80820069	32oz RTU	022179104082	LG 6338	12/12	National
80820196	32oz RTS	022179104297	LG 6334	12/12	National
80820067	1 qt. Concentrate	022179103917	LG 6336	12/12	National
80820068	1 gal. Concentrate	022179104068	LG 6344	4/4	West

Complete Disease Control

Unique B.T. formula controls powdery mildew, downy mildew, botrytis, fusarium, fire blight, and many more hard to control diseases. Bee friendly. New biofungicide and bactericide that can be used as a foliar spray or soil drench.

Not for sale in ND, ON 8oz, 32oz RTS, Gal



Item #	Desc	UPC	Vendor	CS/UOS	Location
80820220	8 oz. Concentrate	022179104433	LG 3370	6/6	National
80820221	16 oz. Concentrate	022179104440	LG 3374	6/6	National
80820209	32 oz. RTU	022179104488	LG 3174	12/12	National
80820298	32 oz. RTS	022179105171	LG 3176	6/6	National
80820297	1 gal. Concentrate	022179104471	LG 3382	4/4	West

Liquid Copper Fungicide RTU

For controlling diseases on vegetables, ornamentals, fruit, and algae in turfgrass. Dormant and growing season fungicide for control of listed plant diseases such as powdery mildew, rust, black spot, leaf and fruit spot, Downey mildew, late blights and leaf curl.

Not for sale in AR, ND, SC, WV, WY, DC



Item #	Desc	UPC	Vendor	CS/UOS	Location
80820230	32 oz. RTU	022179104617	LG 3154	12/12	National

Epsom Salts

Promotes bloom in roses and other flowering plants. Absorbed through the roots and foliage of plant. Epsom salts are a source of Magnesium that is essential to plant development. It is required by plants to produce chlorophyll. It also helps plants absorb Phosphorus. Promotes blooms in roses and other flowering plants.

Not for sale in ND



Item #	Desc	UPC	Vendor	CS/UOS	Location
80820143	4 lb.	022179100848	LG 7220	6/6	National

Fruit Tree Spray

Fruit Tree Spray Plus is a broad spectrum insecticide, fungicide and miticide for home garden use. This highly effective organic spray utilizes pyrethrins plus neem oil for fast and thorough action against a long list of targeted pests and diseases. Monterey Fruit Tree Spray Plus will act as an "exciter" to flush pests out of their hiding places and into direct contact with the spray. **Not for sale in AK, NE, ND, WY**



Item #	Desc	UPC	Vendor	CS/UOS	Location
80820273	1pt. Concentrate	022179104013	LG 6182	6/6	National
80820063	1 pt. RTS	022179104006	LG 6186	12/12	National

Foli-Cal®

This is a liquid calcium formulation based on 10% calcium acetate. Foli-Cal® will correct calcium-deficiency disorders such as blossom end-rot on tomatoes, peppers, eggplant and bitter-pit in apples. Foli-Cal® works on vegetables, tree and vine crops as well.

Not for sale in KY, ND, WY



Item #	Desc	UPC	Vendor	CS/UOS	Location
80820308	1pt. Concentrate	022179100817	LG 7204	6/6	National

Fish & Guano®

This organic concentrated fertilizer is made of liquid fish and bird guano. This is a high analysis 9-6-2 natural fertilizer that can be applied monthly during the growing season. Whether at home or on a farm, this liquid fertilizer is excellent for your flowers, trees, transplants, and vegetables. Great for use on indoor houseplants.

Not for sale in ND, WY



Item #	Desc	UPC	Vendor	CS/UOS	Location
80820227	1 qt. Concentrate	022179103894	LG 7265	12/12	National



DIY Multi Insect Killer

This product is a perfect option for controlling adelgids, aphids, chafers, thrips, elm leaf beetles, leafhoppers, leaf miners, Japanese beetles, mealy bugs, whiteflies and many more. DIY Multi-Insect Killer is specifically designed for insect control for landscape ornamentals, residential trees and interior plantscapes. It is not designed for treating any food-bearing plants.

Not for sale in AL, AK, AR, CT, DE, FL, GA, HI, IN, KY, LA, ME, MA, MS, MT, NH, NJ, NY, NC, ND, RI, TN, VT, WV, WY, DC, CO, MD, NV

Item #	Desc	UPC	Vendor	CS/UOS	Location
80820059	15 ml	654702001218	LG 6220	12/12	West



Fungi-Max Multi Purpose Fungicide

Fungi-Max prevents and controls all major plant diseases including anthracnose, brown patch, copper spot, dollar spot, leaf spot, melting out, crown rot, leaf smuts, powdery mildew, rust, red thread, and spring dead spot. The fungicide is perfect for outdoor use on roses, flowers, ornamentals, shrubs, trees, lawns, fruit and nut trees, berries, and vegetables. **Not for sale in ND, WV, DC**



Item #	Desc	UPC	Vendor	CS/UOS	Location
80820210	8 oz. Concentrate	022179104631	LG 3213	6/6	National
80820211	1 pt. Concentrate	022179104648	LG 3216	6/6	West

Horticultural Oil

This pest control is great for use on aphids, leaf miners, thrips, leafhoppers, spider mites, scales, whiteflies, mealy bugs and many more. It gives poor control for caterpillar & worms. However, it does control eggs of all insects. Our insecticide is for use on a variety of trees & plants including apples, almonds, avocados, citrus, peaches, pecans, blackberries, figs, pineapple and more.



Bug Buster II

Bug Buster II is specially formulated for homeowner use to control over 100 garden and nuisance pests in lawns, ornamentals, vegetables, flowers, fruits, and roses. Kills Japanese beetles, cicadas, fleas, ticks, ants, and tomato hornworms. Contains the proven active ingredient, Esfenvalerate. **Not for sale in AK, HI, NE, ND, WY, DC**



Item #	Desc	UPC	Vendor	CS/UOS	Location
80820275	1 pt. Concentrate Not For Sale in ND, WY	022179103740	LG 6286	6/6	National
80820077	32oz. RTS Not For Sale in ND, WY	022179103771	LG 6294	12/12	National
80820243	32oz. RTU Not For Sale in AR, DC, DE, ID, ND, NE, NH, OK, RI, WV, WY	022179104907	LG 6302	12/12	National
80820276	1 qt. Concentrate Not For Sale in ND, WY	022179103757	LG 6299	6/6	National
80820078	1 gal. Concentrate Not For Sale in ND, WY	022179103764	LG 6292	4/4	West

Item #	Desc	UPC	Vendor	CS/UOS	Location
80820226	8 oz. Concentrate	022179104723	LG 6378	12/12	National
80820271	1 pt. Concentrate	022179103313	LG 6382	6/6	West

Vegetable & Ornamental Weeder

Promotes bloom in roses and other flowering plants. Absorbed through the roots and foliage of plant. Epsom salts is a source of Magnesium that is essential to plant development. It is required by plants to produce chlorophyll. It also helps plants absorb Phosphorus. Promotes blooms in roses and other flowering plants. **Not for sale in WA, DC**



Item #	Desc	UPC	Vendor	CS/UOS	Location
80820266	1 pt. Concentrate	022179101098	LG 5146	6/6	National
80820267	1 qt. Concentrate	022179101104	LG 5149	6/6	West

70% Neem Oil

A Fungicide/Insecticide/Miticide that helps control black spot, powdery mildew, rust, needle rust, downy mildew, spider mites, aphids, whiteflies, twig and tip blight, anthracnose, scab and flower, botrytis, alternaria, and other insect pests.

Not for sale in OR. RTU not for sale ND



Fruit Tree & Vegetable Systemic Soil Drench

This pest control is great for use on aphids, flea beetles, leafhoppers, trips, whiteflies, Japanese beetles, mealy bugs and many more. Our soil drench is designed for use on tree & nut crops including Bananas, citrus, grapes, berries, pome fruits, stone fruits, cashews, pistachios, chestnuts, walnuts, avocados, mangos and many more. **Not for sale in CT, DE, ME, MD, MA, NE, NH, RI, VT, WY, DC, MT, NJ, NY**



Item #	Desc	UPC	Vendor	CS/UOS	Location
80820222	8oz Concentrate	022179104716	LG6128	12/12	National
80820053	16 oz. RTS	022179102668	LG 6145	12/12	National
80820079	32 oz. RTU	022179103276	LG 6148	12/12	National
80820281	1 Pt. Concentrate	022179101678	LG 6127	6/6	National
80820190	1 gal. Concentrate	022179104174	LG 6142	4/4	West

Item #	Desc	UPC	Vendor	CS/UOS	Location
80820361	1 qt. Concentrate	022179103788	LG 6274	6/6	National
80820061	1 gal. Concentrate	022179103795	LG 6278	4/4	West



Liqui-Cop®

Liquid copper fungicide spray for disease prevention on fruit trees, nut crops, citrus, vegetables and ornamentals. Very economical replacement for Bordeaux mixture with an expanded label. Liqui-Cop is extremely waterproof and does not require oil or a sticker. A replacement for lime sulfur. Can be mixed with oils such as Monterey Horticultural Oil, for use as a dormant spray on fruit trees.



Not for sale in ND

Item #	Desc	UPC	Vendor	CS/UOS	Location
80820229	8oz Concentrate	022179104754	LG 3102	12/12	National
80820049	32 oz. RTS	022179102576	LG 3190	12/12	National
80820296	1pt Concentrate Not For Sale in AK, AL, AZ, IA, KY, ND, NE, NM, WY	022179100114	LG 3104	6/6	National
80820365	1qt Concentrate	022179100121	LG 3109	6/6	West
80820048	1gal Concentrate	022179103306	LG 3117	4/4	West

Tomato Blossom Spray

This ready to spray fertilizer/herbicide can be used on tomatoes, cucumbers, squash, peppers, eggplant, melons, pumpkins, okra, strawberries, and other blooming crops. This spray increases the number of blossom sets and promotes flower growth for larger plant yields.

Not for sale in WA



Item #	Desc	UPC	Vendor	CS/UOS	Location
80820355	16oz. RTU	022179103986	LG 7234	6/6	National

Florel Brand Growth Regulator

This plant growth regulator prevents unwanted nuisance fruit or nut formation on numerous trees listed on the label, including crabapple, flowering pear, flowering plum, maple, chestnut, olive, sweet gum (liquidambar), sour orange and more.



Item #	Desc	UPC	Vendor	CS/UOS	Location
80820397	1pt Concentrate For residential application only in AZ, CA, NY, WA	022179105027	LG 4142	6/6	West
80820398	1qt Concentrate For residential application only in AZ, CA, NY, WA	022179105034	LG 4146	6/6	West
80820290	1qt Not For Sale in CA, NY, WA	022179101340	LG 4107	6/6	West
80820395	1gal Concentrate Not For Sale in CA, NY, WA	022179100350	LG 4110	4/4	West
80820399	1gal Concentrate For residential application only in AZ, CA, NY, WA	022179105041	LG 4150	4/4	West

Sucker-Stopper® RTU

This ready to use formula stops suckers on apples, pears, olives, and many woody ornamentals. Just spray on base of plant to control regrowth of suckers from roots and pruning wounds.



Item #	Desc	UPC	Vendor	CS/UOS	Location
80820110	16 oz. RTU	022179103924	LG 4300	6/6	National

Ant, Roach & Spider Spray

Household insecticide with quick knockdown plus extended residual control. Kills roaches, ants, fleas, ticks, spiders, earwigs, silverfish and many more. For residual indoor and outdoor use.

Not for sale in AK, AR, AZ, DC, DE, GA, HI, IA, ID, IL, IN, KS, KY, LA, MD, ME, MN, MS, MT, ND, NE, NH, NY, NY, OR, RI, TN, UT, VA, VT, WI, WV, WY



Item #	Desc	UPC	Vendor	CS/UOS	Location
80820363	32 oz. RTU	022179105089	LG 6162	12/12	West

Garden Phos

For control of root rot, downy mildew, fire blight, sudden oak death (s.o.d.), phytophthora & pythium diseases and other listed diseases. Can be used as soil drench, foliar spray, or basal bark application. **Not for sale in NY**



Item #	Desc	UPC	Vendor	CS/UOS	Location
80820301	8 oz. Concentrate	022179104549	LG 3303	6/6	National
80820302	1 qt. Concentrate	022179104556	LG 3307	6/6	National
80820217	1 gal. Concentrate	022179104563	LG 3312	4/4	East

Mark-It Blue

MARK-IT BLUE is a concentrated blue colorant designed to provide temporary highly-visible evidence of spray application patterns. MARK-IT BLUE readily dissipates, is non-toxic and totally compatible with water-soluble solutions.



Item #	Desc	UPC	Vendor	CS/UOS	Location
80820303	1 pt. Concentrate	022179104624	LG 1142	12/12	West
80820116	1 qt. Concentrate	022179103825	LG 1128	12/12	National
80820115	8 oz. Concentrate	022179101395	LG 1130	12/12	National



Star Thistle Killer

Use to control susceptible broadleaf weeds on established forage grasses in permanent ranchette grass pastures.

Available in CA & NV Only



Item #	Desc	UPC	Vendor	CS/UOS	Location
80820188	8oz. Concentrate	022179103221	LG 5468	6/6	West

Thistledown

For selective control of broadleaf weeds in rangeland and permanent grass pastures. This concentrated herbicide will treat 1/2 - 2/3 acre. Controls Canada thistle, musk thistle, yellow star thistle, knapweed and more in home pastures and non-crop areas with no grazing restrictions. Active ingredient: 40.9% clopyralid **Not for sale in CA, HI, NV, NH, NY, OR, RI, DC**



Item #	Desc	UPC	Vendor	CS/UOS	Location
80820020	1 pt. Concentrate	022179103269	LG 5482	6/6	National

Brush & Vine Control

Controls woody plants and vines in residential areas. Use to kill stumps and prevent regrowth of unwanted trees and shrubs. Controls vines such as poison oak and poison ivy. Active ingredient: 8.8% triclopyr **Not for sale in DE, ID, IA, ME, MN, NH, NY, ND, RI, SD, WV, WY, DC, VT**



Item #	Desc	UPC	Vendor	CS/UOS	Location
80820261	1 qt. Concentrate	022179103931	LG 5367	6/6	National

Weed Whacker

Including dandelions; oxalis; poison oak, spurge, rush, clover, aster and thistle. Consider these hard-to-control weeds as good as gone. Our 3-way herbicide is designed for warm & cool season turf. It's safe to use on Bluegrass, Fescue, Rye, St. Augustine, Bahia, Common Bermuda, Centipede, Zoysia and bent. Active Ingredients: 2,4-D, dimethylamine salt 4.55%, 2,4-DP-p, DMA salt 2.26%, MCP-P, DMA salt 2.3%. 1 quart covers 20,000sq ft



Item #	Desc	UPC	Vendor	CS/UOS	Location
80820240	18oz Jet Spray	022179104808	LG 5268	12/12	National
80820034	1 qt. Concentrate	022179100893	LG 5285	12/12	National
80820035	1gal. Concentrate	022179100923	LG 5290	4/4	National

Spurge Power®

Spurge Power is a broadleaf herbicide for residential lawns. Controls dandelions, chickweeds, clover, oxalis, spurge, wild violet and many other broadleaf weeds. An 8 oz. bottle covers 8,000 sq. ft. and a pint covers 16,000 sq. ft. Active ingredient: 56% MCPA + 5.1% triclopyr + 3.6% dicamba



Item #	Desc	UPC	Vendor	CS/UOS	Location
80820262	8oz. Concentrate	022179104815	LG 5592	6/6	National
80820263	1 pt. Concentrate	022179101159	LG 5599	6/6	National

Turflon Ester Specialty Herbicide

Turflon Ester controls bermudagrass, kikuyugrass and certain broadleaf weeds such as oxalis, ground ivy, wild violet, clover and ragweed. Consider these nuisances as good as gone. Our spray is used for the control of actively growing plants. Only emerged weeds present at the time of application will be controlled. Active: 60.45% triclopyr. One pint covers up to 20,000 sq. ft. **Not for sale in AK, ME, MA, MN, NH, ND, SD, DC**



Item #	Desc	UPC	Vendor	CS/UOS	Location
80820021	8oz. Concentrate	022179101067	LG 5512	6/6	National
80820022	1 pt. Concentrate	022179101050	LG 5518	6/6	National

Grass Getter

Grass Getter controls grassy weeds in bedding plants, ornamentals, ground covers, shrubs, and vegetables. This systemic herbicide kills most annual and hard-to-kill perennial grasses, as well as hard to control species such as crabgrass, bermudagrass, foxtail, goosegrass, johnsongrass, quackgrass and other listed grassy weeds. It will not control nutsedge (nutgrass), annual bluegrass (poa annua) or broadleaf weeds.



Item #	Desc	UPC	Vendor	CS/UOS	Location
80820005	8oz. Concentrate Not For Sale in DC, ME, ND, NY	022179100961	LG 5328	6/6	National
80820358	8oz. 2 Pack Not For Sale in AR, DC, CO, ID, MD, ME, MI, ND, NY, OK, UT, VA, WV	022179101180	LG 5330	6/6	East

Crab-E-Rad® Plus

For control of selective broadleaf weeds and certain grassy weeds in residential and ornamental turfgrasses. Use to control crabgrass, dandelion, clover, henbit, plantains, wild onion and many other listed lawn weeds. **Not for sale in AK, AR, CT, DR, FL, HI, ID, LA, MD, ME, MT, NY, RI, SD, VT, WY**



Item #	Desc	UPC	Vendor	CS/UOS	Location
80820258	8oz Concentrate	022179105003	LG 5208	6/6	National
80820259	1pt Concentrate	022179105010	LG 5212	6/6	West



Herbicide Helper

Herbicide Helper is a spreader / penetrant for use with herbicides for improves performance. Herbicide Helper improves the wetting of foliage and gets better results for a faster weed kill. And helps the herbicides stick to the targeted weeds. **Not for sale in ME**



Item #	Desc	UPC	Vendor	CS/UOS	Location
80820357	1 pt. Concentrate	022179100138	LG 1104	6/6	National
80820356	8 oz. Concentrate	022179101173	LG 1109	6/6	West

Monterey® Magnify

Use on lawns, ornamentals and non-crop areas. Formulated with ammonium salts, non-ionic surfactants and anti-foaming agents. Enhances the biological activity and leaf-surface penetration of herbicides, defoliant and desiccants whose labels specify the addition of ammonium sulfate/nitrate and/or surfactants. **Not for sale in AR, ID, IL, KY, MA, ME, MS, ND, TN, UT**



Item #	Desc	UPC	Vendor	CS/UOS	Location
80820366	1 qt. Concentrate	022179104242	LG 1150	12/12	West

Once A Year Insect Control II

Used as a soil drench on ornamental trees, shrubs and certain fruit and nut trees. Controls adelgids, leaf beetles, leafhoppers, mealy bugs, scale, whiteflies, borers (including the Emerald Ash borer) and many others. No spraying, just use around the roots as a soil drench for full season insect control.

Not for sale in CT, MA, ME, MD, ND, DC, VT



Item #	Desc	UPC	Vendor	CS/UOS	Location
80820282	1 qt. Concentrate	022179102620	LG 6342	6/6	National
80820081	1gal Concentrate	022179102637	LG 6350	4/4	National

Mosquito Control

Kills mosquitos that may transmit West Nile Virus. Controls outdoor pests for up to 6 weeks. Use on lawns, trees, shrubs, roses, ornamentals, and around house foundations. **Not for sale in AL, AK, AZ, AR, CT, DE, FL, GA, HI, ID, IA, KS, LA, ME, MI, MN, MS, MO, MT, NE, NV, NM, ND, OK, OR, SC, SD, TN, TX, UT, WV, WI, WY**



Item #	Desc	UPC	Vendor	CS/UOS	Location
80820364	32oz RTS	022179105225	LG 6264	6/6	National
80820383	32oz RTU	022179105515	LG 6312	12/12	West
80820280	1 qt. Concentrate	022179105133	LG 6279	6/6	West

Remuda Weed & Grass Killer

Remuda Full Strength is a non-selective herbicide, it kills both annual and perennial grass, like crabgrass and many broadleaf weeds in lawns like thistle, clover, creeping charlie and poison ivy. This is post emergent herbicide is a 41% glyphosate concentrate with surfactant. Glyphosate is the worlds most commonly used herbicide. **Not for sale in AK, CO, FL, IL, IN, KS, KY, LA, ME, MD, MA, MN, MS, MO, NE, NV, NH, NM, NC, ND, PA, RI, SC, SD, TN, TX, VT, VA, WV, WI, WY, DC**



Item #	Desc	UPC	Vendor	CS/UOS	Location
80820015	1pt Concentrate	022179101586	LG 5180	12/12	National
80820016	1qt Concentrate	022179101593	LG 5185	12/12	National
80820017	1 gal Concentrate	022179101609	LG 5190	4/4	National
80820018	2.5 gal Concentrate	022179101616	LG 5195	2/2	West

Mite & Insect Control

Repels and eliminates mites, aphids, caterpillars, chinch bugs, fleas, mole crickets, ticks, whiteflies and many other listed pests. For use on lawns, trees, shrubs, roses, and ornamentals. Can be used around house foundations to kill and repel roaches, and more. **Not for sale in AK, FL, ID, KS, KY, ME, MD, MN, MT, NH, NM, NY, ND, WV, WY, DC**



Item #	Desc	UPC	Vendor	CS/UOS	Location
80820277	1 pt. Concentrate	022179105096	LG 6172	6/6	National
80820278	1 qt. Concentrate	022179105102	LG 6228	6/6	National

Yellowjacket Trap

Lures and traps yellowjackets and wasps. Contains a non-hazardous bait made from common food products which are attractive to yellowjackets and wasps. Easy to use. **Not for sale in KY, NM, OK**



Item #	Desc	UPC	Vendor	CS/UOS	Location
80820409	2 traps per pack	022179105973	LG 8614	12/12	East

Outdoor Fly Trap

Lures and traps all types of common flies such as house flies, little house flies, blow flies, cluster flies and garbage flies. Contains a non-hazardous bait made from common food products which are attractive to flies. Easy to use. **Not for sale in KY, NM, OK**



Item #	Desc	UPC	Vendor	CS/UOS	Location
80820408	2 traps per pack	022179105980	LG 8344	12/12	East



Codling Moth Trap & Lure

Codling moths are a worldwide pest that attacks apples, pears, walnuts and quince, so these are the trees to use it on. **Not for sale in LA, NM, OK**



Item #	Desc	UPC	Vendor	CS/UOS	Location
80820167	2 traps per pack	022179102279	LG 8500	12/12	West

Citrus Leafminer Trap

Control unwanted insects in your greenhouse, home, and garden. Pesky insects are attracted to the bright, yellow color and then killed by the powerful sticky glue. Eco-friendly and non-toxic. After use can be disposed of in your trash or compost. **Not for sale in CO, LA, OK**

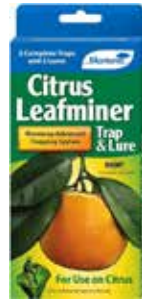

Item #	Desc	UPC	Vendor	CS/UOS	Location
80820166	2 traps per pack	022179102897	LG 8920	12/12	West

Peach Tree Borer Trap

Attracts and traps Peach Tree Borers. Use any time during the growing season to capture moths. Treat as appropriate to control pests. **Not for sale in CO, NM**



Item #	Desc	UPC	Vendor	CS/UOS	Location
80820173	2 traps per pack	022179102712	LG 8710	12/12	West

Yellow Sticky Trap

Catch and monitor insects. Attracts insects by imitating a very healthy plant leaf. Catches insects at the onset of proliferation, so treatment can be applied before infestation causes damage to plants. **Not for sale in KY, NM, OK**



Item #	Desc	UPC	Vendor	CS/UOS	Location
80820386	5 traps per pack	022179102309	LG 8800	12/12	National

Dr. Iron Resealable Bag

Corrects iron deficiency fast with lasting results. Won't stain concrete or burn foliage. Environmentally friendly. Apply 3.5 lbs per 1,000 sq. ft. Controlled release for seasonlong feeding.



Item #	Desc	UPC	Vendor	CS/UOS	Location
80820136	7 lb. bag	022179102705	LG 7115	8/8	National
80820138	21 lb. bag	022179102477	LG 7122	4/4	West
80820139	40 lb. bag	022179101517	LG 7117	2/2	West

Pentra-Bark®

Superior nonionic wetting agent, designed to improve penetration of water-based basal applications through bark. May be used in agriculture, horticulture, industrial, and forestry applications. Designed for fast-spreading, uniform distribution and absorption of spray on leaf and stem surface. **Not for sale in AR, MS, NY, UT**



Item #	Desc	Vendor	CS/UOS	Location
80820127	1 qt. Concentrate	LG 1160	12/12	West

Seed Starter 1-1-1

The nutrients in Monterey® Seed Starter help promote growth of the seedling when applied to newly seeded lawns, vegetable gardens and other seed plantings. Improving soil nutrition encourages a vigorous root system for plants. **Not for sale in AR, FL, GA, KY, MS, MO, MT, NE, NH, ND, SC, SD, VT, VA, WV, WY**



Item #	Desc	UPC	Vendor	CS/UOS	Location
80820345	1 gal Concentrate	022179105331	LG 7358	4/4	West

Iron Tree Treats

Monterey® Iron Tree Treats are readily soluble capsules formulated to help alleviate yellowing (iron chlorosis) and other micronutrient deficiencies in trees. **Not for sale in AR, FL, KY, MS, MO, MT, NE, NH, ND, SC, VT, WV, WY**



Item #	Desc	UPC	Vendor	CS/UOS	Location
80820350	Capsules	022179105348	LG 7360	8/8	West



Cool Power Herbicide

Premium ester formulation for cool weather weed control in early spring and fall. Controls hard to kill weeds like spurge, ground ivy, wild violet, and many other listed weeds. **Not for sale in AK, DC, HI, MA, VT**



Item #	Desc	UPC	Vendor	CS/UOS	Location
80820320	1 qt Concentrate	191662014327	TO 5624	6/6	West

Sedgehammer

Selective herbicide for the control of nutsedge, horsetail, and other weeds. Can be used in turfgrass, ornamentals, landscaped areas, and non-crop areas. 5% Halosulfuron-methyl. **Not for sale in AK**



Item #	Desc	UPC	Vendor	CS/UOS	Location
80820264	.5oz	714654514980	LG 5405	12/12	National

Tree Feast™ 5-7-5

Monterey® Tree Feast™ is specifically formulated to help promote plant and root growth in trees. **Not for sale in AR, KY, MS, MO, NE, ND, SC, SD, VT, WV, WY**



Item #	Desc	UPC	Vendor	CS/UOS	Location
80820351	1 gal Concentrate	760755100409	LG 7364	4/4	West

Pasture Fertilizer 18-2-2

Monterey pasture fertilizer is specially formulated to encourage strong growth of pasture grasses and legumes. Applying this fertilizer improves the growth of your pasture improving grazing for horses, cattle or other livestock. **Not for sale in SD**



Item #	Desc	UPC	Vendor	CS/UOS	Location
80820249	1 gal Concentrate	022179104891	LG 7103	4/4	West

Iron Combo™

Iron Combo™ is a broad spectrum micronutrient fertilizer designed to help correct and prevent iron and other micronutrient deficiencies. The iron, copper, manganese and zinc are complexed in a soluble form ready for absorption. **Not for sale in AR, KY, NE, NH, ND, SC, SD, VT, WV, WY**



Item #	Desc	UPC	Vendor	CS/UOS	Location
80820385	32 oz. RTS	022179105522	LG 7376	10/10	West
80820339	1qt. Concentrate	022179105294	LG 7350	10/10	West
80820340	1 gal. Concentrate	022179105300	LG 7352	4/4	West

Turf Booster

Turf Booster has been specially formulated for lawns and turf. Monterey® Turf Booster contains 3 forms of nitrogen for effective use during growth and development. The nutrients found in Monterey® Turf Booster may enhance turf growth and soil nutrition. **Not for sale in AR, KY, MD, MO, MT, NE, ND, SC, SD, VT, WV, WI, WY**



Item #	Desc	UPC	Vendor	CS/UOS	Location
80820337	1qt. Concentrate	760755020103	LG 7346	10/10	West
80820338	1gal. Concentrate	760755100102	LG 7348	4/4	West



Biting Insect Repellent

Best Yet is the ultimate in personal relief from mosquitoes, fleas, flies, ticks, green heads, chiggers, no-see-ums and gnats. A light misting application of this Cedar Oil Solution will provide all day protection. It will not sweat off like DEET products or other natural insect repellents. Best Yet can be used on children of all ages and animals of any kind. It can be applied directly to the skin or over clothing.

Item #	Desc	UPC	Vendor	CS/UOS	Location
80120022	2.5 oz RTU	081435624252	BY 125	24/24	East
80120023	4 oz. RTU	081435304284	BY 104	28/28	East



Insect Disease & Mite Control

Kills listed insects, diseases, and mites. Controls ants, aphids, mites, spider mites, whiteflies, fruit flies, ear wigs, and many more. Fungicide controls blackspot, powdery mildew, rust, scab, leaf spot, and more.



Item #	Desc	UPC	Vendor	CS/UOS	Location
82270002	28 oz RTS	687073061253	706125D	4/4	National
82270100	24 oz RTU	687073071009	707100D	4/4	National

Home Insecticidal Soap

Home Insecticidal Soap protects ornamental and edible plants from damaging insects such as aphids, mealybugs, mites, whiteflies, and more. For use on vegetables, flowers, fruit, and houseplants. Use indoors or outdoors. Active ingredients: potassium salt of fatty acids.



Item #	Desc	UPC	Vendor	CS/UOS	Location
82270095	24 oz RTU	687073062304	706230A	8/8	National
82270020	1 gal RTU	840216200425	820042A	4/4	National

Lawn Weed and Disease Control

Kills listed weeds including dandelion, common chickweed, clover, and more down to the root. See visible results in hours. Fungicide controls rust, dollar spot, lichens, and more.



Item #	Desc	UPC	Vendor	CS/UOS	Location
82270023	24 oz RTU	840216200494	820049B	8/8	National

Houseplant Insect Killer

Provides quick control of pests in minutes, including Aphids, Mealybugs, Scale Insects, Whiteflies, Spider Mites and more. Controls powdery mildew on houseplants, flowers, shrubs and trees. Use to protect houseplants indoors and outdoors, and it is safe to use on flowers and shade trees.



Item #	Desc	UPC	Vendor	CS/UOS	Location
82270022	24 oz RTU	840216200487	820048B	8/8	National

Neem Oil

Neem Oil is an easy to use option for listed pests and diseases. For use on roses, flowers, fruits and vegetables. Controls aphids, whiteflies and spider mites. Controls black spot, rust and powdery mildew. Can be used up to the day of harvest. For Organic gardening.



Item #	Desc	UPC	Vendor	CS/UOS	Location
82270097	24 oz RTU	687073062502	706250A	8/8	National
82270019	1 gal RTU	840216200401	820040A	4/4	National

Rose & Flower Insect Disease & Mite Control RTU

Protect your favorite flowers from both fungal diseases and pests controls insects, diseases and mites including spider mites, aphids, caterpillars, whiteflies, and other listed pests for use on roses, flowers, ornamental trees and shrubs ideal for controlling rose diseases prevents leaf loss caused by black spot and rust.



Item #	Desc	UPC	Vendor	CS/UOS	Location
82270094	24 oz RTU	687073062205	706220B	8/8	National

YOU'VE GOT A PERENNIAL PARTNER IN US

Quality inputs yield the best finished crops. Griffin partners with accomplished perennial breeders and producers to bring you the best in seed, cuttings and young plants. Explore our seed and vegetative perennial assortments in our Seed & Plant catalog.

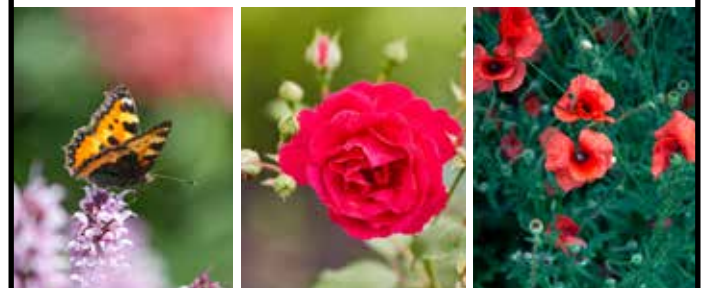

ORGANOCIDE

Plant Rx

An organic systemic bactericide, fungicide, virucide, and psyllid repellent used by growers all over the world. Plant Rx is used to control HLB (Citrus Greening), fire blight, bacterial spec, and many other aggressive plant and flower bacteria. It helps control psyllids, nematodes, and various plant viruses. It helps control plant and flower fungus including, but not limited to, powdery mildew, downy mildew, botrytis, and more as listed.



Item #	Desc	UPC	Vendor	CS/UOS	Location
80490054	24oz RTU	850045873110	223-024	12/12	West
80490055	32oz Concentrate	850045873134	223-032	12/12	West

WeedTaliator

An OMRI listed organic, systemic, broad-spectrum herbicide made from essential oils carried by powerful and unique surfactant components. Weed Taliator is designed to kill weeds and grass all the way to the root system. Organocide Weed Taliator helps eliminate the toughest of weeds including, but not limited to, dandelion, crabgrass, ragweed, field bindweed, nutsedges, purslane, smuts grass, and more.



Item #	Desc	UPC	Vendor	CS/UOS	Location
80490058	16oz Concentrate	850045873172	224-016	12/12	West
80490059	24oz RTU	850045873349	224-024	12/12	West
80490060	32oz Concentrate	850045873189	224-032	12/12	West

2025

Bee Safe 3-in-1 Garden Spray

An OMRI listed insecticide, fungicide, and miticide that has been trusted by gardeners for more than 25 years. It is effective on small, soft-bodied insects including, but not limited to, spider mites, thrips, mealy bugs, scales, and certain fungal diseases, as listed. This product is soft on beneficial insects and will NOT harm bees or adult butterflies. It kills all stages of small, soft-bodied insects: eggs, larvae, nymphs, and adults.



Item #	Desc	UPC	Vendor	CS/UOS	Location
80490037	16oz Concentrate	850045873028	221-016	12/12	West
80490038	24oz RTU	850045873011	221-024	12/12	West
80490039	32oz RTS	850045873059	221-232	10/10	West
80490040	32oz Concentrate	850045873035	221-032	12/12	West

Bee Safe Insect Killer

An OMRI listed natural insecticide for plants. It kills eggs, larvae, nymphs, and adult stages of over 25 soft-bodied insects including, but not limited to, aphids, hemlock wooly adelgid, citrus rust mites, leafrollers, mealy bugs, scale insects, spider mites, thrips, whiteflies, psyllids, and fungus gnats. The concentrate can be used as a soil drench and is extremely effective at eliminating the life cycle of fungus gnats and mites.



Item #	Desc	UPC	Vendor	CS/UOS	Location
80490047	16oz Concentrate	850045873080	222-016	12/12	West
80490048	24oz RTU	850045873073	222-024	12/12	West
80490049	32oz RTS	850045873240	222-232	10/10	West
80490050	32oz Concentrate	850045873097	222-032	12/12	West



Preen

Extended Control Weed Preventer

Stop weeds before they start and prevent weeds from occurring for up to 6 months. **Not for sale in NY, NB**



Item #	Desc	UPC	Vendor	CS/UOS	Location
80350331	4.93lb (805sqft)	088685640926	2464092	4/4	National
80350583	10lb Bag (1,630sqft)	088685642067	2464206	1/1	East

Preen

Garden Weed Preventer Plus Plant Food

Prevents weeds and feeds plants in one easy step. Balanced fertilizer promotes abundant blooms, increased yields and strong root development. Safe for use around over 200 established flowers, vegetables, trees and shrubs. One application fertilizes your plants and prevents weeds for up to three months.



Item #	Desc	UPC	Vendor	CS/UOS	Location
80350103	5.625lb (900sqft) Not For Sale in NB	088685639029	2163902	4/4	National
80350106	16lb (2,560sqft) Not For Sale in CA, NB	088685639067	2163907	1/1	East

Garden Weed Preventer

The flower and garden weed preventer. Proven effective with 180 varieties of bulbs, flowers, roses, shrubs, trees and vegetables. Stops weeds before they start. Apply just once and enjoy weed-free gardens for up to 14 weeks. Ready to use granular form requires no measuring or mixing. Contains 1.47% Trifluralin. **Not for sale in NB**



Item #	Desc	UPC	Vendor	CS/UOS	Location
80350093	5.625lb (900sqft)	088685637933	2463795	4/4	National
80350096	13lb (2,080sqft)	088685637780	2463798	1/1	East
80350097	16lb (2,560sqft)	088685638008	2463800	1/1	East
80350098	31.3lb (5,000sqft)	088685636776	2463802	1/1	East

Natural Vegetable Garden Weed Preventer

Enjoy a weed-free vegetable garden without all the work. Preen Natural Vegetable Garden Weed Preventer is the natural way to keep weeds from sprouting! Use the natural weed control in your fruit, vegetable, herb, and landscape beds anytime during the growing season to save time from back-breaking weeding. Formulated to control some of toughest weeds, like clover, bluegrass, crabgrass, foxtail, lambsquarters and plantain. Just sprinkle around established vegetables, herbs, and fruits once a month to prevent weeds from returning to your garden. Children and pets can play in the area immediately after application. Made of 100% corn gluten meal.

Not for sale in SD, NB



Item #	Desc	UPC	Vendor	CS/UOS	Location
80350343	5lb (250sqft)	088685641534	2464153	4/4	National



TrapStik for Flies

The TrapStik® for Flies uses VisiLure™ technology to lure flies with appealing colors and a multi-dimensional pattern. Flies are attracted by the colors and patterns on the TrapStik®, then get stuck to the adhesive surface. Catches common house flies, cluster flies, fruit flies, and gnats. Indoor use.



Item #	Desc	UPC	Vendor	CS/UOS	Location
80220031	Fly TrapStik	042853400002	TSF-BB8	8/8	National

Japanese & Oriental Beetle Trap

Catches two destructive pests: the Japanese beetle and the Oriental beetle. An all-in-one trap with no accessories to buy. New easy-lock bottom allows the trap to be emptied and reused; and the floral and pheromone lure lasts the entire beetle season. The double-layer nylon bag is highly durable and the design ensures the bag stays attached. Catch capacity is four times larger than the competition.



Item #	Desc	UPC	Vendor	CS/UOS	Location
80220005	Beetle Trap	042853780487	JBTZ-DB12	12/12	East
80220110	Refill	042853784485	JBTR-DB12	12/12	National

Fruit Fly Trap

Indoor trap uses a food-based lure and color proven attractive to fruit flies. Catches fruit flies that congregate and breed near fruit, vegetables and food scraps. Simply add the liquid attractant to the trap and it starts catching fruit flies in minutes. Each trap comes with a 30-day supply of attractant and is reusable with fruit fly trap attractant refills. Safe to use around food. Non-toxic. Once caught, fruit flies will drown in the non-toxic liquid attractant.



Item #	Desc	UPC	Vendor	CS/UOS	Location
80220112	Trap	042853610005	FFTR2-SF5	5/5	National
80220053	Refill	042853620004	FFTA-DB12	12/12	National

Pop! Fly Trap

RESCUE! POP! Fly Trap is the same superior RESCUE!® fly trap in a large-capacity. Empty and rebait with a refill packet to use again. After desired use and reuse, trap is recyclable.



Item #	Desc	UPC	Vendor	CS/UOS	Location
80220021	Traps	042853750176	PFTR-BB4	4/4	West
80220024	Refill	042853751173	PFTA-DB12	12/12	West



FlyPad Trap

This is not your average sticky fly trap. FlyPad's unique corrugated texture features glue-filled grooves to catch flies, while the ridged surface stays clean to the touch during setup and disposal. When it comes to trapping flies, RESCUE!



Item #	Desc	UPC	Vendor	CS/UOS	Location
80220148	2pk shelf pk of 16	042853470005	FP2-DB16	16/16	National

Deck & Patio Fly Trapstik

Uses our exclusive VisiLure® technology to draw insects with appealing colors and a multi-dimensional pattern. Flies are attracted by the colors and patterns, then get trapped on the sticky surface. Outdoor use. Also catches biting flies.



Item #	Desc	UPC	Vendor	CS/UOS	Location
80220105	Fly Trapstik	042853420017	TSBF-BB6	6/6	National

Big Bag Fly Trap

Disposable trap designed for areas with heavy fly concentrations. It's proven to catch common nuisance and filth flies, including house flies, false stable flies, blow flies, blue and green bottle flies, flesh flies, face flies and many others. Easy to use - just add water and the fast-acting attractant starts luring flies to the trap. Holds up to 40,000 flies.



Item #	Desc	UPC	Vendor	CS/UOS	Location
80220001	Fly Bag Trap	042853797010	BFTD-DB12	12/12	National

Disposable Fly Trap

Fast-acting attractant dissolves and activates quickly once water is added. Proven to catch common nuisance or filth flies including house flies, cluster flies, false stable flies, blow flies, bottle flies, flesh flies and others. Place outdoors near household garbage bins, compost piles, dog kennels and other areas with flies. Sanitary; no need to touch the attractant or the flies. Holds up to 20,000 flies.



Item #	Desc	UPC	Vendor	CS/UOS	Location
80220004	12piece Display Box	042853773014	FTD-DB12	12/12	National

TrapStik for Wasps

The TrapStik® for Wasps catches paper wasps, carpenter bees and mud daubers. Catches queens and workers, from spring through fall. Can be placed near a nest to reduce populations.



Item #	Desc	UPC	Vendor	CS/UOS	Location
80220032	Wasp TrapStik	042853500016	TSW-BB6	6/6	National
80220095	Display 48-pk	042853500016	TSW-FD48	1/1	National

Carpenter Bee Trap

RESCUE!® Carpenter Bee TrapStik employs our exclusive VisiLure colors and patterns proven to attract carpenter bees. Our TrapStik works like nothing else on these pests.



Item #	Desc	UPC	Vendor	CS/UOS	Location
80220106	Carpenter Bee Trap	042853520007	CBTS-BB6	6/6	National

W-H-Y® Trap - Wasp • Hornet • Yellowjacket

Captures multiple species of stinging pest insects: Paper Wasps, Bald-faced Hornets, European hornets and Yellowjackets and more. The RESCUE!® team of scientists has spent years developing a combination of three attractants and a distinctive double chamber design for the W-H-Y Trap. Non toxic mode of action.



Item #	Desc	UPC	Vendor	CS/UOS	Location
80220011	Trap	042853801007	WHYTR-BB8	8/8	National
80220093	Refill	042853811006	WHYTA-DB6	6/6	National

Ant Bait Stations

A dual-bait formula that includes protein and carbohydrate in a form that is easy to ingest and transport. When placed where ant activity is seen, the foraging ants enter the bait station to find food and their colony. This will not only kill the workers but also will wipe out the queen and next generation of ants. Mess-free/won't spill. Child resistant. Visible results overnight. Ants find it fast.



Item #	Desc	UPC	Vendor	CS/UOS	Location
80220145	4 Pack Box	10042853640009	AB4-SF12	4/4	National



Disposable Yellowjacket Trap

Effective in targeting and trapping all of the major species of yellowjacket found in North America. Perfect for picnics and camping trips. No killing agents - Once trapped, yellowjackets simply drown in the liquid. Water-soluble attractant included - Just add water and hang.



Item #	Desc	UPC	Vendor	CS/UOS	Location
80220002	Trap	042853776039	YJTD-DB12-E	12/12	East
80220035	Trap	042853775032	YJTD-DB12-W	12/12	West



Reusable Yellow Jacket

Reusable Yellowjacket Trap features a durable dual-chamber design that holds up in sunlight for many seasons of use. Clear plastic walls give you the satisfaction of seeing the yellowjackets accumulate while knowing the insects can't escape.

Item #	Desc	UPC	Vendor	CS/UOS	Location
80220038	Trap	042853720179	YJTR-SF4	4/4	National
80220041	4-week Refill	042853740177	YJTA-DB12	12/12	National
80220141	10-week Refill	0428563742225	YJTC-BB72	72/72	National



Bird Bath & Fountain Maintenance

This safe but fast-acting enzyme-based formula reduces and eliminates muck, dead leaves, and odors. When applied to fresh water it will super charge naturally occurring bacteria.



Item #	Desc	UPC	Vendor	CS/UOS	Location
82430062	8oz.	768980880028	88002	12/12	East

Fountain Clarifier

This fountain enzyme clarifier product is designed to keep your fountain clean and clear by breaking down organic waste, debris and other contaminants. Simply add Fountain Clarifier to your fountain water, and let it work its magic.



Item #	Desc	UPC	Vendor	CS/UOS	Location
82430063	8oz.	768980880035	88003	12/12	East

Fountain Algaecide & Clarifier

Effectively eliminates green water algae, string and hair algae, blanketweed algae and others. Non-hazardous, non-staining, and non-foaming when used as directed. Controls green water to keep pond water clean and clear in ornamental ponds and water gardens. Treats up to 8,000 gallons.



Item #	Desc	UPC	Vendor	CS/UOS	Location
82430068	8oz.	768980880158	88015	12/12	East

Multi-Use 20% Vinegar

Natural and safe 20% industrial strength white vinegar. Multi-use and perfect for cleaning, laundry, automotive and gardening. Perfect replacement for harmful household chemicals.



Item #	Desc	UPC	Vendor	CS/UOS	Location
82430065	1 gal Conc.	768980880097	88009	4/4	East
82430067	1 qt Conc.	768980880110	88011	12/12	East



Year-Round® Horticultural Oil Spray – for Gardens

Premixed Year-Round® Spray Oil in a convenient quart spray bottle. Labeled specifically for outdoor use. For organic gardening.



Item #	Desc	UPC	Vendor	CS/UOS	Location
80530022	32 oz. RTU	018506001223	122	12/12	National

Year-Round® Horticultural Oil Spray House Plant

Labeled specifically for indoor use. For organic gardening. Ready-to-use for house plants.



Item #	Desc	UPC	Vendor	CS/UOS	Location
80530023	32oz RTU Houseplants	018506001230	123	12/12	National

Tick Take Tick Removal Spoons

The Summit Tick Take Tick Removal Spoons are a safe and easy way to remove ticks from people and pets. Comes in a handy pack of 3 – one for home, car, backpack, etc. Small, lightweight design lets you take a spoon along when gardening, hiking or doing other outdoor activities.



Item #	Desc	UPC	Vendor	CS/UOS	Location
80530093	3-count card	018506001537	153	12/12	National

Year-Round® Horticultural Oil Spray

Versatile plant protection without the use of synthetic toxins. Protects garden plants and ornamentals in and around the home; use on fruit trees and edibles up to the day of harvest. Controls aphids, spider mites, fungus gnats, scale, white fly and many other common plant pests. Odorless and non-irritating. Highly refined oil will not burn or brown plants even in direct sunlight. Approved for organic gardening.



Item #	Desc	UPC	Vendor	CS/UOS	Location
80530020	1 gal. Concentrate	018506001209	120-4	4/4	National
80530065	1 pt. Concentrate	018506000103	113-6	6/6	National
80530066	1 qt. Concentrate	018506000127	114-6	6/6	National
80530067	1 qt. RTS	018506001216	121-6	6/6	National

Sticky Trap Houseplant Insect Traps

Yellow sticky traps for indoor or outdoor use. Attracts and traps gnats, whiteflies, aphids, and other insects hiding in your potted plants. Non toxic and pesticide free.



Item #	Desc	UPC	Vendor	CS/UOS	Location
80530127	12 traps per pack	018506001858	185-24	24/24	National

Mosquito Bits®

Simply sprinkle in any standing water - including water gardens. Like the Mosquito Dunks®, this product kills mosquito larvae before they become adult (biting) mosquitoes. Quick Kill Bits™ will eliminate mosquito larvae within 24 hours. The Mosquito Bits® are now labeled to control Fungus Gnats in plant beds or pots!



Item #	Desc	UPC	Vendor	CS/UOS	Location
80530009	8 oz.	018506001162	116-12	12/12	National
80530011	30 oz.	018506001179	117-6	6/6	National

Deer Ban®

Unique Gel-tablet application provides effective year-round protection from wildlife damage. Uses predator urine triggering animal flight response. Natural and biodegradable. Drop capsules every 5-10 ft around coverage area or place in planters. Perfect around gardens and ornamentals. Easy-to-use and odorless to humans; effective up to 90 days.



Item #	Desc	UPC	Vendor	CS/UOS	Location
80530052	50 Pack	018506020019	2001	12/12	National

Mosquito Dunks®

Kills mosquitoes before they are old enough to bite. Made with BTI, a natural, soil borne bacteria. Approved for use around fish, birds, wildlife, people, pets and plants. Kills mosquito larvae for 30 days or longer. Simply place a floating Mosquito Dunk® in areas where water collects around your home. Each Dunk® will take care of up to 100 sq. ft. of water surface regardless of depth. Approved for organic production.



Item #	Desc	UPC	Vendor	CS/UOS	Location
80530001	2 Dunks	018506001025	102-12	12/12	National
80530003	6 Dunks	018506001100	110-12	12/12	National



Mosquito Dunk Chunks

Summit® Mosquito Dunk Chunks® kill mosquitoes before they're old enough to bite! Simple and safe to use around people, plants, pets, fish, and livestock.



Item #	Desc	UPC	Vendor	CS/UOS	Location
80530095	5 count	018506001759	175-12	12/12	National

Mosquito & Gnat Barrier

Mosquito and gnat barrier contains permethrin, a residual insecticide that provides up to four weeks of repellency for a wide variety of insect pests including mosquitoes, ants, fleas, ticks and more. Spraying your backyard can help to reduce suitable mosquito resting area (usually vertical vegetation) and therefore reduce your chances of being bitten. Spraying down wooded areas that your dog frequents can aid in reducing the risk of tick born illness for your pet and family.



Item #	Desc	UPC	Vendor	CS/UOS	Location
80530082	1qt RTS	018506000103	010-6	6/6	National



Insect Dust

Made from 100% Food-Grade Diatomaceous Earth, a fossilized hard shelled algae. Insect Dust is like crawling over broken glass to insects but is harmless to pets and humans. Use indoors or out, around the foundation of your home as a barrier, on vegetable plants, ornamentals, houseplants, on slugs, snails, ant mounds, earwigs, in cracks and crevices, sprinkle on mattresses to kill bed bugs, on carpet to kill fleas or anywhere else insects are found.



Item #	Desc	UPC	Vendor	CS/UOS	Location
80660021	4.4 lb.	699064500207	50020-7	6/6	East

Milky Spore Powder

A one time application using only one teaspoonful every 4 feet in a checker board pattern on your lawn. 10 oz. - will treat 2,500 sq. ft. Apply anytime the ground is not frozen. Ten year performance guarantee on the Japanese Beetle Grub (can last up to twenty years). Not harmful to humans, animals or the environment, safe to use around water ways. Kills the grub stage of the Japanese beetle.



Item #	Desc	UPC	Vendor	CS/UOS	Location
80660032	10 oz.	699064800109	80010-9	6/6	East



Gopher/Mole Repellent

Utilizing the powerful scent of essential oils, Wilco repellent products safely repel rodents and keep them away.



Item #	Desc	Vendor	CS/UOS	Location
82590049	4 Repellent Balls	10000	4/4	West

Squirrel Repellent

Utilizing the powerful scent of essential oils, Wilco repellent products safely repel rodents and keep them away.



Item #	Desc	Vendor	CS/UOS	Location
82590050	4 Repellent Balls	10001	4/4	West

Rodent Repellent

Utilizing the powerful scent of essential oils, Wilco repellent products safely repel rodents and keep them away.



Item #	Desc	Vendor	CS/UOS	Location
82590054	4 Repellent Balls	10004	4/4	West

Zinc Homeowner Bait

Containing the acute toxin Zinc Phosphide (2.0%), this single-feed formula is presented on wheat for use to control pocket gophers. Available in 1 lb. for homeowners. No permit and/or license is required. **Not for sale in AL, AK, CT, DE, FL, GA, HI, ID, IL, IN, KY, ME, MD, MA, MI, MS, NH, NJ, NY, NC, OH, PA, RI, SC, TN, VT, VA, WV, WI, WY, DC**



Item #	Desc	UPC	Vendor	CS/UOS	Location
82590001	1lb	091017600161	60016	12/12	West



Gopher Getter Type 2

Ideal for managing pocket gopher infestations. Containing .005% Diphacinone, this formula is a multiple-feed solution requiring the gopher to eat the bait 3-4 days continuously. An anise coating is adhered to milo grain, acting as an attractant and producing high palatability among pocket gophers. **Not for sale in AL, AR, CO, CT, DE, FL, GA, HI, ID, IL, IN, IA, KS, KY, ME, MD, MA, MI, MN, MS, MO, MT, NH, NJ, NM, NY, NC, ND, OH, PA, RI, SC, SD, TN, VT, VA, WV, WI, DC**



Item #	Desc	UPC	Vendor	CS/UOS	Location
82590002	1lb	091017210162	21016	12/12	West
82590003	5lb	091017210056	21005	6/6	West

Ground Squirrel Bait

Bait is pelletized to emulate their natural food source and encourage them to eat the bait, not to store it. It contains the anticoagulant Diphacinone (.005%) and is a multiple-feed solution requiring the rodent to consume 3-4 days of continuous feeding. Bait station required. **Not for sale in AL, AK, AR, CO, CT, DE, FL, GA, HI, IL, IN, IA, KS, KY, ME, MD, MA, MI, MN, MS, MO, MT, NE, NH, NJ, NY, NC, ND, OH, OK, PA, RI, SC, SD, TN, TX, VT, VA, WV, WI, WY, DC**



Item #	Desc	UPC	Vendor	CS/UOS	Location
82590006	4lb	091017310046	31004	6/6	West
82590007	20lb	091017310206	31020	1/1	West
82590019	Station	091017390000	39000	6/6	West

2025

Gopher Getter Midget with Bait Type 2

A safe and simple tool that gives the occasional user a reasonable method of controlling pocket gophers. Applicator tool dispenses bait subsoil, likely only allowing the gopher to come into contact with the bait and helps to prevent secondary exposure. **Not for sale in AL, AK, AR, CO, CT, DE, DC, FL, GA, ID, IA, IL, IN, HI, KS, KY, MA, ME, MD, MI, MN, MO, MS, MT, NC, ND, NH, NJ, NM, NY, OH, PA, PR, RI, SC, SD, TN, VA, VT, WV, WI**



Item #	Desc	UPC	Vendor	CS/UOS	Location
82590027	Midget w/ 1lb Bait	091017701004	70101	1/1	West

Rat & Mouse Bait Station

Molded of heavy-duty plastic to withstand any type of abuse, bait station is sized for rat and mouse control applications. Measuring at 10" x 6" x 3 1/4", it is ideal to place under work benches, cabinets, warehouse pallets, etc. Includes a child resistant cap for refilling and provisions to anchor it to the ground.



Item #	Desc	UPC	Vendor	CS/UOS	Location
82590020	Station	091017390017	39001	6/6	West

Gopher Getter Applicator with Bait Type 2

The Wilco Gopher Bait Applicator is recommended for anyone with several acres, or for commercial use requiring extensive gopher control. This tool is a hand operated probe that dispenses Wilco's gopher bait underground into the gopher's natural runway. This keeps the bait away from birds, pets and children. There is no danger of harming children or other animals when used as instructed. **Not for sale in AL, AK, AR, CO, CT, DE, DC, FL, GA, ID, IA, IL, IN, HI, KS, KY, MA, ME, MD, MI, MN, MO, MS, MT, NC, ND, NH, NJ, NM, NY, OH, PA, PR, RI, SC, SD, TN, VA, VT, WV, WI**



Item #	Desc	UPC	Vendor	CS/UOS	Location
82590022	Applicator w/ 1lb Bait	091017706009	70601	1/1	West



FAST-TRACK YOUR
**PLANT
SALES**

Cut crop time with quick finish liners or pre-finished plants from Griffin. Our young-plant network serves all major regions of the country with quality material and reliable fill rates. Contact your Griffin sales representative or browse current availability on griffins.com.



CROP SUPPORT



CHECK OUT OUR
CLEARANCE ITEMS!



Griffin Greenhouse Retail WAREHOUSE Shipping Map

We are now shipping nationwide!

NATIONAL

CROP SUPPORT

2025



Refer to location key:

National items are stocked nationally
 Select items are sold East or West only; no exceptions

8" Kaleidoscope Planter

Premium plastic modular planter can be displayed individually each planter has a removable saucer ideal for succulents or shallow rooted planted.

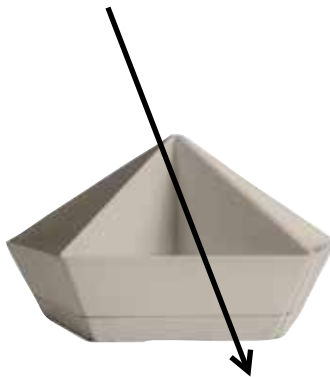

Item #	Desc	UPC	Vendor	CS/UOS	Location
80282643	Vanilla Bisque	770932844170	KDP08000A58	6/6	National

Where is the pricing?

1. Scan QR code on Chapter Pages to see pricing on Griffins.com
2. Contact your Griffin Sales Representative
3. Call into Griffin Customer Service 800.888.0054





Diamond Espalier Trellis

Heavy Duty Espalier Trellis with Diamond Accent can be used for freestanding or in-ground. Redwood construction resists decay when directly on the ground, enhances the beauty of your outdoor space, provides a natural wood solution for climbing plants and vines, creates filtered sunlight and shade for an outdoor space, and adds visual interest to fences or walls.



Item #	Desc	UPC	Vendor	CS/UOS	Location
82620004	3ft X 7ft	604280006372	37NDE	2/2	West



Fan Trellis

Light Duty Fan Trellis can be used for freestanding or on ground. Redwood construction resists decay when directly on the ground, enhances the beauty of your outdoor space, provides a natural wood solution for climbing plants and vines, creates filtered sunlight and shade for an outdoor space, and adds visual interest to fences or walls.

Item #	Desc	UPC	Vendor	CS/UOS	Location
82620001	2x4 ft	604280004040	24NTFAN	6/6	West
82620002	6 ft	604280004262	6NTFAN	6/6	West
82620003	8 ft	604280004989	8NTFAN	6/6	West
82620018	Red 6 ft	791167736009	6RGTFAN	6/6	West



Fan Espalier Trellis

Light Duty Trellis can be used for freestanding or in-ground. Redwood construction resists decay when directly on the ground, enhances the beauty of your outdoor space, provides a natural wood solution for climbing plants and vines, creates filtered sunlight and shade for an outdoor space, and adds visual interest to fences or walls.

Item #	Desc	UPC	Vendor	CS/UOS	Location
82620005	2x4 ft	604280004248	24NEFAN	6/6	West
82620006	2.5x7 ft	604280004224	2127NEFAN	6/6	West
82620007	3x4 ft	604280004033	34NEFAN	6/6	West
82620016	Green 3'x3'	604280005030	3GGEFLR	6/6	West

Heavy Duty Fan Trellis

Heavy Duty Espalier Trellis can be used for freestanding or in-ground. Redwood construction resists decay when directly on the ground, enhances the beauty of your outdoor space, provides a natural wood solution for climbing plants and vines, creates filtered sunlight and shade for an outdoor space, and adds visual interest to fences or walls.



Item #	Desc	UPC	Vendor	CS/UOS	Location
82620008	3.5ft x 6ft	604280006266	3126NEFANHD	2/2	West

House Plant Trellis

Light Duty Trellis can be used for freestanding or in-ground applications or attached to existing structures. Redwood construction resists decay when directly on the ground, enhances the beauty of your outdoor space, provides a natural wood solution for climbing plants and vines, creates filtered sunlight and shade for an outdoor space, and adds visual interest to fences or walls.



Item #	Desc	UPC	Vendor	CS/UOS	Location
82620009	1.5ft x 2ft	604280004019	1122NBEFLR	6/6	West

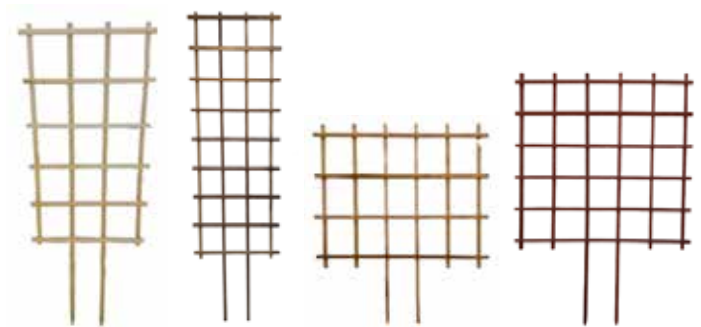

Espalier Trellis

Light Duty Espalier Trellis can be used for freestanding or in-ground. Redwood construction resists decay when directly on the ground, enhances the beauty of your outdoor space, provides a natural wood solution for climbing plants and vines, creates filtered sunlight and shade for an outdoor space, and adds visual interest to fences or walls.

Item #	Desc	UPC	Vendor	CS/UOS	Location
82620017	22"x40"	850044240067	2240NGE	6/6	West
82620010	2'X7'	604280004255	27NE	6/6	West
82620012	3'x3.5'	604280004217	3312NE	6/6	West
82620024	3.5'x5'	604280004095	3125NSE	6/6	West
82620013	5'x5'	604280005108	55NGE	6/6	West
82620011	Green 3'x3'	791167736504	33GGE	6/6	West
82620015	Green 5'x5'	604280005122	55GGE	6/6	West
82620014	Red 4'x4'	791167736702	44RGE	6/6	West



Majestic

Heavy Duty Fan Trellis can be used for freestanding or in-ground applications or attached to existing structures. Redwood construction resists decay when directly on the ground, enhances the beauty of your outdoor space, provides a natural wood solution for climbing plants and vines, creates filtered sunlight and shade for an outdoor space, and adds visual interest to fences or walls.



Item #	Desc	UPC	Vendor	CS/UOS	Location
82620022	2'x7'	604280006693	27NME	2/2	West



Heavy Duty Trellis

Made with 1"x2" pieces of wood. Light Duty Trellis can be used for freestanding or in-ground. Redwood construction resists decay when directly on the ground, enhances the beauty of your outdoor space, provides a natural wood solution for climbing plants and vines, creates filtered sunlight and shade for an outdoor space, and adds visual interest to fences or walls.

Item #	Desc	UPC	Vendor	CS/UOS	Location
82620019	1.5'x3.5'	604280006143	112312NEHD	6/6	West
82620020	2'x3.5'	604280006242	2312NEHD	6/6	West
82620021	3'x3.5'	604280006341	3312NEHD	6/6	West
82620029	2'x7.5'	604280006280	2712NLTHD	2/2	West
82620030	4'x6'	604280006464	46NLTHD	2/2	West
82620031	4'x7.5'	604280006488	4712NLTHD	2/2	West

2025

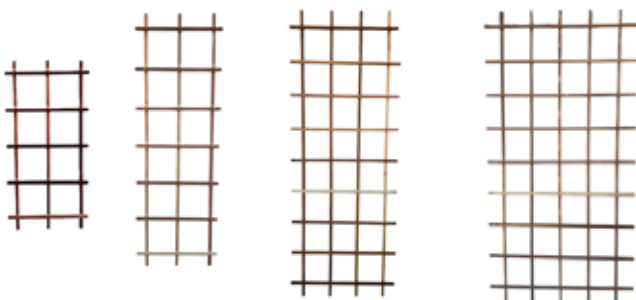

Ladder Trellis

Trellises are for vines, fruit trees, and other plants that need upward growth. Not for standing on.

Item #	Desc	UPC	Vendor	CS/UOS	Location
82620028	Red 2'x4'	850044240074	24RLT	6/6	West
82620025	2'x6'	604280004415	26NLT	6/6	West
82620026	3'x8'	604280004439	38NLT	6/6	West
82620027	4'x8'	604280004842	48NLT	6/6	West

Square Espalier

Light Duty Square Trellis can be used for freestanding or in-ground applications or attached to existing structures. Redwood construction resists decay when directly on the ground, enhances the beauty of your outdoor space, provides a natural wood solution for climbing plants and vines, creates filtered sunlight and shade for an outdoor space, and adds visual interest to fences or walls.



Item #	Desc	UPC	Vendor	CS/UOS	Location
82620023	3'	604280004026	3NSE	6/6	West

Simple Ties w/ Nails

Used to secure tree supports



Item #	Desc	UPC	Vendor	CS/UOS	Location
82620063	24" 12 bags of 6 pack	850044240005	24ST6PK	1/1	West
82620064	32" 12 bags of 6 pack	850044240012	32ST6PK	1/1	West
82620065	36" 12 bags of 6 pack	850044240029	36ST6PK	1/1	West

Redwood Planter

This smooth natural redwood planter from A&G Agricultural Supply features rounded formal corners. It is smooth, sturdy, and hand made. Beautiful for outdoor plants.



Item #	Desc	UPC	Vendor	CS/UOS	Location
82620050	8"x10"x24"	604280015022	81024FP	1/1	West
82620051	8"x10"x36"	604280015039	81036FP	1/1	West
82620052	8"x10"x48"	604280015046	81048FP	1/1	West



Redwood

These stakes are for tree support.

Item #	Desc	UPC	Vendor	CS/UOS	Location
82620032	1"x3'	604280560034	113R	25/25	West
82620033	1"x4'	604280030049	114R	25/25	West
82620034	1"x5'	604280030056	115R	25/25	West
82620035	1"x6'	604280030063	116R	25/25	West
82620036	1"x7'	604280030070	117R	25/25	West
82620037	1"x8'	604280030087	118R	25/25	West
82620038	1"x2"x7'	604280056179	127R	12/12	West
82620039	1"x2"x8'	604280056186	128R	12/12	West
82620040	2"x2"x6'	604280030223	226R	6/6	West
82620041	2"x2"x7'	604280030278	227R	6/6	West
82620042	2"x2"x8'	604280030278	228R	6/6	West

Pine Poles

Treated Pine Poles are essential, pre-treated wooden poles designed



for a range of agricultural and outdoor applications. These durable poles offer reliable support and structure for various needs such as fencing, construction, and landscaping. Resistance against decay and pests, makes them a practical choice for long-lasting projects in agriculture and outdoor settings. These stakes are for tree support.

Item #	Desc	UPC	Vendor	CS/UOS	Location
82620061	Treated 8' (3-pack)	850044240036	BYKT	1/1	West
82620062	Untreated 8' (3-pack)	850044240043	BYKU	1/1	West

Green

Great for use with shrubs, vines, tomatoes, and vegetables. Lightweight but durable.



Item #	Desc	UPC	Vendor	CS/UOS	Location
82620043	1"x3'	850044240142	113GR	25/25	West
82620044	1"x4'	604280031046	114GR	25/25	West
82620045	1"x5'	604280031046	115GR	25/25	West
82620046	1"x6'	604280031060	116GR	25/25	West
82620047	2"x2"x8'	604280031121	228GR	9/9	West

Lodge Pole

Pine Lodge Pole Treated-Brown. Ideal for supporting newly planted trees · Pencil pointed at one end for easy installation.

Item #	Desc	UPC	Vendor	CS/UOS	Location
82620048	8'	604280032081	2148TPP	1/1	West
82620049	10'	604280032104	210TLP	1/1	West



Coco Grow Pole

These poles are made with all-natural coconut coir that helps to retain moisture and nutrients that aid in overall plant health. Provides vertical support for climbing plants and vines, each pole includes a hollow PVC pipe that is stackable and allows for ample drainage.



Item #	Desc	UPC	Vendor	CS/UOS	Location
80690896	1.57 x 15.75"	849637006968	CP01	36/36	East
80690897	1.77 x 23.62"	849637006975	CP02	20/20	East
80690898	1.77 x 35.43"	849637006982	CP03	36/36	East

Bendable Coco Grow Pole

In addition to providing versatile support for climbing plants and vines, these bendable coco fiber poles aid in retaining moisture and nutrients for overall plant health. Each pole includes a flexible wire with the ability to create unique shapes and add visual appeal to your plants.



Item #	Desc	UPC	Vendor	CS/UOS	Location
80690964	1.5 x 24"	849637009037	CP07	20/20	East
80690965	1.5 x 36"	849637009044	CP08	36/36	East

Plastic Grow Pole

Our Plastic Grow Pole is crafted from toughened PET material, ensuring exceptional durability and long-lasting support for your plants. Fill with moss, coco coir, or other medium and watch your plants thrive with this high-quality pole.



Item #	Desc	UPC	Vendor	CS/UOS	Location
80691029	2.4x17"	849637009907	CP11	36/36	East

BOSMERE

Nutscene Twine Balls

A 164' spool of 3-ply twine in 10 colors: lime green, green, natural, dark blue, sky blue, orange, pink, black, red and purple.



Item #	Desc	UPC	Vendor	CS/UOS	Location
82010191	Assort.Colors 164' Ea Ball	5012519430150	K808	36/36	National



Wren Scroll Trellis

Perfect for popping into containers or in the garden to give blooms and foliage support. Heavy duty green plastic coated for long lasting durability.

Item #	Desc	UPC	Vendor	CS/UOS	Location
82010675	12" x 5"	721082125053	L505	12/12	National
82010677	24" x 10"	721082125152	L515	12/12	National
82010676	18" x 8"	600679001188	L510	12/12	National
82010570	36" x 16"	600679001362	L530	6/6	National

Ladder Pot Trellis

Great for popping into containers or in the garden to give blooms and foliage support. Heavy duty green plastic coated for long lasting durability 11.5" tall x 4" wide.

Item #	Desc	UPC	Vendor	CS/UOS	Location
82010144	Ladder style 11.5" x 4"	721082125039	L503	24/24	National

Wraparound Peony Support

This wrap around brace is the answer to a messy flower bed affected by wind and rain. Plastic coated to prevent rusting. The hoop of the wrap-around can be unhooked and wrapped around the grown plant or bush. Three legs provide strength and stability.

Item #	Desc	UPC	Vendor	CS/UOS	Location
82010705	15"x25"	721082056708	E670	24/24	National

Grid Support

This multiple bloom flower support suitable for many types of bushy flowers. Made of strong wire coated with dark green UV stabilized plastic. The grid construction of the frame gives individual bloom support.

Item #	Desc	UPC	Vendor	CS/UOS	Location
82010642	18"x25"	721082056302	E630	12/12	National

Net Grow Tunnel

The durable, green poly mesh net grow tunnel features drawstring ends and is wrapped over strong galvanized steel hoops. The mesh on this grow tunnel protects your young plants from strong sunlight while still allowing light and rain to filter through. The galvanized steel hoop frame and easy drawstring ends make this grown tunnel even more practical. Plus, it folds for easy storage.



Item #	Desc	UPC	Vendor	CS/UOS	Location
82010940	118"L x 17.75"W x 17.75"H	721082128436	L843	5/5	National



Wood Obelisk



Item #	Desc	Vendor	CS/UOS	Location
81790082	15"x15"x61"	9/802/1	1/1	East



Trellis Netting 7" Reach Through Nylon Mesh

Weatherproof nylon scrog netting proudly made in the USA with premium quality, heavy duty 7" mesh and not easy to tear.



Item #	Desc	UPC	Vendor	CS/UOS	Location
82170054	5' X 15'	016069000059	TP-15C	12/12	National
82170055	5' X 30'	016069000196	TP-30C	12/12	National
82170056	5' X 60'	016069001667	TP-60	12/12	National



Deer-X Protective Netting

Keep destructive deer away from your garden, vegetables, fruits, shrubs, trees or flowers with this high-quality garden fence animal barrier.



Item #	Desc	UPC	Vendor	CS/UOS	Location
82170026	Premium 7'X50'	016069006259	DXP-12	12/12	National
82170024	7' X 100' / Cut Case Display	016069000493	DX-7	6/6	National
82170025	14' X 75'	016069000509	DX-14	6/6	National



Mow-Over Tree Stake Kit

Protect trees for easy mowing without trimming around stakes.

Item #	Desc	UPC	Vendor	CS/UOS	Location
82170065	Tree Staking Kit	016069000721	TSD-12	12/12	National

Garden Staples Shelf Display

Secure landscape fabrics and films, garden netting, floating garden covers and burlap tightly to the ground. Constructed of durable steel, staples are easy to push into and pull out of the ground.

Item #	Desc	UPC	Vendor	CS/UOS	Location
82170013	4" 20-Pack	016069003937	GS-20	24/24	National
82170015	4" 40-Pack	016069004743	GS-40BW	24/24	National

Harvest-Guard Roll Display

All-season protection blanket against frost, insects, birds, and heavy rain.

Item #	Desc	UPC	Vendor	CS/UOS	Location
82170073	40"x50'	016069004019	GF-4050	28/28	National

Weed-Shield® Fabric Barrier

Use the grid pattern on this landscape fabric for easy garden layout and planting.

Item #	Desc	UPC	Vendor	CS/UOS	Location
82170202	3' x 50'	016069003067	WS3-50	20/20	National
82170201	3' x 100'	016069003074	WS3-100	12/12	National

Bird-X Protective Netting

Bird-X protects fruits and berries from thieving birds and other garden pests. The durable polypropylene mesh will protect your plants ensuring that birds and pests don't destroy them. The netting is easy to install and is available in multiple sizes.



Item #	Desc	UPC	Vendor	CS/UOS	Location
82170019	7' X 20' /Cut Case Display	016069000073	BN-1	12/12	National
82170020	14' X 14' /Cut Case Display	016069000080	BN-2	12/12	National
82170023	14' X 75'	016069000158	BN-5	6/6	National
82170022	14' X 45' /Cut Case Display	016069000141	BN-4	6/6	National
82170021	28' X 28'	016069000134	BN-3	6/6	National

Kwik Grips Plant Ties

Kwik Grips Plant Ties are an easy-to-use, multi-purpose solution for securing branches and plants across all seasons. The soft, flexible "hook and loop" design provides a simple method of securing plants, vines, branches, wraps, and covers. There are also multiple securing uses outside of the garden.



Item #	Desc	UPC	Vendor	CS/UOS	Location
82170048	25' Roll	016069005184	SG25-12	12/12	National

Twist Tie with Cutter

Easily and safely secure several plants to existing supports using these Gardeneer Twist Tie Plant Securers with Cutter. Using supports throughout your garden helps your favorite plants or crops grow upright, fostering healthy root systems. These rolls each include 100' of sturdy twist ties, made from lasting, plastic coated wire.



Item #	Desc	UPC	Vendor	CS/UOS	Location
82170047	100' Roll	016069004361	TWST-100	15/15	National

Stretch Tie

Secure your large plants to their stakes using the Gardeneer Stretch Tie Gardener's Wrap. This innovative material easily wraps around your plants to help keep them upright while growing. The wrap expands with the growth of your plant, preventing damage to the stem. The 0.5" width is perfect for keeping the ties unobtrusive, and the 150 foot length will yield several sturdy ties. Use the durable Stretch Tie Gardener's Wrap to help your plants grow tall and strong.



Item #	Desc	UPC	Vendor	CS/UOS	Location
82170196	1/2" x 150'	016069004354	ST-150	12/12	National



Harvest Guard

Harvest Guard Blanket is an easy-to-use blanket that floats over crops without support. When using Harvest Guard Blanket for seed germination, you will see up to 100% improved seed germination (versus straw) due to the protective cover trapping heat and moisture, in turn speeding up and increasing seed germination. Harvest Guard Blanket will also help protect against frost, insects and birds.



Item #	Desc	UPC	Vendor	CS/UOS	Location
82170072	10' x 15' Cut Case Display	016069000387	GF-1015	12/12	National

Harvest-Guard Frost Protection

The Harvest-Guard Plant Protection Bag provides fall and winter protection against harsh wind, frost, snow and ice damage for shrubs, small trees, and potted plants.



Item #	Desc	UPC	Vendor	CS/UOS	Location
82170078	8' x 6' Frost Protection Bag	016069005191	SPB5-6	12/12	National

Harvest-Guard Premium Blanket

During the winter, these protectors offer just the right air, light, and waterpermeability to promote a safer environment for your plants while helping trap heat and moisture to speed up germination to improve crop yield.



Item #	Desc	UPC	Vendor	CS/UOS	Location
82170076	10'x12'	016069004989	HGP-1012	6/6	National
82170077	10'x20'	016069004996	HGP-1020	4/4	National

Scorch Guard

Protect your garden from intense summer sun! Prevent your garden from getting burnt. Diffuse sunlight from plants while refracting white light.



Item #	Desc	UPC	Vendor	CS/UOS	Location
82170206	10'x15'	016069006938	SG-1015	12/12	National

Jute Trellis

Our heavy-duty Nylon trellis netting is ideal for growing tomatoes, peas, cucumbers and other vining plants. This trellis supports the vertical growth of plants which produces bigger, healthier harvests, reduces damage from insects, rodents and ground rot, increases harvests from small garden spaces and helps keep produce clean. Use of the product and harvesting are made easy with the tangle-free, 5 in. reach-through mesh design.



Item #	Desc	UPC	Vendor	CS/UOS	Location
82170190	5" Mesh 5' x 30'	016069007119	TNAT-30	12/12	National



Bird And Pond Netting

Bird netting is an environmentally safe mesh netting constructed of polypropylene strands and has a 3/4" hole opening. Bird netting is the humane way to prevent animals from feeding on and harming trees, bushes, flowers and other plants.



Item #	Desc	UPC	Vendor	CS/UOS	Location
80010192	7' X 10'	042579823369	BPN710	28/28	National
80010193	7' X 20'	042579823376	BPN720	14/14	National
80010189	14' X 14'	042579823383	BPN1414	11/11	National
80010190	14' X 45'	042579823390	BPN1445	7/7	National
80010191	28' X 28'	042579823406	BPN2828	7/7	National

Natural Burlap

Natural burlap is ideal for soil erosion control, plant protection, wind screen, and tree wraps. Medium-weave burlap is the biodegradable.



Item #	Desc	UPC	Vendor	CS/UOS	Location
80010004	3' x 12'	042579431205	NB312	30/30	National
80010005	3' x 24'	042579432400	NB324	20/20	National
80010007	3' x 48'	042579434800	NB348	12/12	National
80010006	3' x 250' Bulk	042579430031	NB3	1/1	National
80010085	6' x 250' Bulk	042579430062	NB6	1/1	West



LANDSCAPE FABRIC

Suppresses weed growth around plants | *Easy-to-use*

Basic Weed Barrier®

An entry-level 1 oz. garden fabric. Allows air, water and nutrients to pass through. It conserves soil moisture and promotes plant growth. UV treated fabric.



Item #	Desc	UPC	Vendor	CS/UOS	Location
80010821	1oz. 3' x 50'	042579824304	DWB10350	28/28	National
80010820	1oz. 3' x 100'	042579824311	DWB103100	15/15	National

Standard Weed Barrier®

Standard Weed Control 1.5 oz. pointbond landscape fabric is great for economical or light/medium duty landscape applications. DeWitt Standard Weed Control stops weeds without chemicals and lets air, water and nutrients pass through.



Item #	Desc	UPC	Vendor	CS/UOS	Location
80010824	3'x50'	042579824328	DWB15350	20/20	National
80010822	3'x100'	042579824335	DWB153100	12/12	National
80010827	4'x300'	042579824380	DWB154300	1/1	National
80010828	6'x300'	042579824397	DWB156300	1/1	National

Professional Weed Barrier®

DeWitt Professional Weed Control 3.0 oz. pointbond landscape fabric is great for heavy duty landscape applications. Professional Weed Control stops weeds without chemicals, resists tears and punctures, and lets air, water and nutrients pass through.



Item #	Desc	UPC	Vendor	CS/UOS	Location
80010848	3' x 50' Earthtone	042579824632	DWB30ET350	12/12	West
80010844	3' x 50'	042579824526	DWB30350	12/12	West
80010842	3' x 100'	042579824533	DWB303100	6/6	West
80010846	4' x 50'	042579824557	DWB30450	12/12	National
80010845	4' x 100'	042579824564	DWB304100	6/6	West

Weed Barrier® Pro Black

Designed specifically for professional landscapers, contractors and garden centers. Specifically made as a landscape and garden fabric, DeWitt Weed-BARRIER® Pro is UV and hydrophilic treated for water permeability. 3oz fabric.



Item #	Desc	UPC	Vendor	CS/UOS	Location
80010028	6' X 300'	042579816071	PRO BLK-6300	1/1	National
80010470	12' X 300'	042579823703	PRO BLK-12300F	1/1	National

Pro-5 Weed Barrier®

Pro-5 Weed Barrier One of the industry's best 5 oz. woven, needle punched, polypropylene fabric designed for professional and commercial use. Pro-5 has been approved by leading landscape architects and government agencies. Pro-5 conserves soil moisture, increases plant growth, and prevents unwanted weeds from germinating. Gold stripes located 12" apart make for easy plant alignment.



Item #	Desc	UPC	Vendor	CS/UOS	Location
80010063	3'x250'	042579132508	P3	1/1	National
80010064	4'x250'	042579142507	P4	1/1	National
80010067	5'x250'	042579152506	P5	1/1	National
80010065	6'x250'	042579162505	P6	1/1	National
80010066	8'x250'	042579182503	P8	1/1	National

Pro Max Weed Barrier®

DeWitt Professional Max Weed Control 4.1 oz. woven landscape fabric is great for heavy duty landscape applications. Professional Max Fabric stops weeds without chemicals, resists tears and punctures, and lets air, water and nutrients pass through.



Item #	Desc	UPC	Vendor	CS/UOS	Location
80010776	4.1oz. 3'x100'	042579824731	DWB413100	6/6	West

CROP SUPPORT

2025



11 Gauge Anchoring Pins

U-shaped steel pins that are angled at their ends for quicker and easier installation by piercing the fabric and penetrating the soil with hand pressure. 6" long x 1" wide.



Item #	Desc	UPC	Vendor	CS/UOS	Location
80010011	P/1000	042579816194	APB1	1000/1000	National
80010058	P/500	042579115006	APB5	500/500	National
80010010	P/48	042579123483	APRC	48/48	National

Contractor Select Plus

DeWitt Contractors Select Plus 2.5 oz. landscape fabric is a spunbond fabric that is 50% stronger than Contractors Select for under pavers and gravel. Allows air, water and nutrients to pass through for beautiful results. Available in grey & black.



Item #	Desc	UPC	Vendor	CS/UOS	Location
80010304	4'x50'	042579817481	CSP-450GREY	20/20	National

Typar Premium

TYPAR® Premium Landscape Fabric blocks weeds around plants; unlike plastic, lets moisture, nutrients and air pass through, and is guaranteed to last for 15 years with proper installation and maintenance.



Item #	Desc	UPC	Vendor	CS/UOS	Location
80010078	1.9oz 3'x25'	039526381775	3201C-501W	30/30	National
80010046	1.9oz 3'x50'	039526381690	3201C-502W	20/20	National

Knitted Shade

DeWitt's Knitted Shade is made from 100% UV stabilized polyethylene. Its unique lock stitch construction allows customers the ability to cut the fabric with scissors without further unraveling.

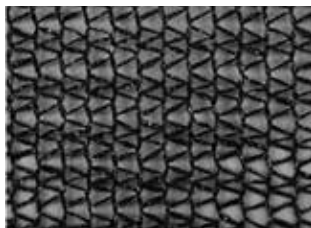

Item #	Desc	UPC	Vendor	CS/UOS	Location
80010422	6' X 100'	042579630417	KG6	1/1	West

Crop Protection Winter Fabric

This 1.5 oz. fabric is ideal for protecting flowering annuals, bedding plants and vegetables from severe cold and freezing. Temperatures underneath the fabric are warmer than outside conditions.

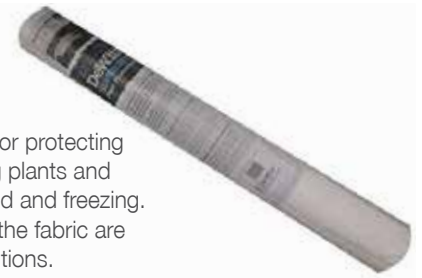

Item #	Desc	UPC	Vendor	CS/UOS	Location
80010234	6'x50'	042597822256	SUPREME650	12/12	National

Garden Edging Box

Garden Edging Box w/Stakes & Connectors embellish the look to your landscape. Edging coil works as a restraint to surround your lawn, deck and garden.



Item #	Desc	UPC	Vendor	CS/UOS	Location
80010697	20'	022401003015	THD-20	1/1	West

Royal Diamond Edge

Royal Diamond 60' edge is perfect for containing mulch soil and decorative stone.



Item #	Desc	UPC	Vendor	CS/UOS	Location
80010222	60'	022401007600	RD-60P	1/1	West

Dear Fence

DeWitt Deer Fence is a safe, humane alternative to wire fencing. It discourages deer and small animals from destroying gardens and other vegetation. Both are an environmentally safe mesh netting made from polypropylene strands bonded together.

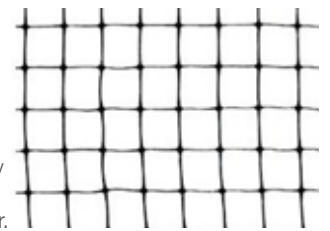

Item #	Desc	UPC	Vendor	CS/UOS	Location
80010022	7' X 100'	042579814299	DDF7100	22/22	National

Shade Tarp

Can be used for many applications including shading people, plants, pets, and greenhouse shading.

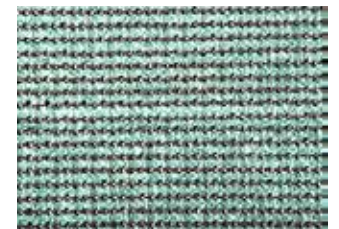

Item #	Desc	UPC	Vendor	CS/UOS	Location
80010602	10'x10'	042579819652	STK60G1010TG2	1/1	National
80010603	10'x20'	042579819669	STK60G1012TG2	1/1	National



Tree Stake Kit

DeWitt Tree Stake Kits are the professional choice for both commercial and residential applications. Each kit includes a unique non-girdling strap, rope, and (3) 15" plastic tree stakes.



Item #	Desc	UPC	Vendor	CS/UOS	Location
80010040	15" stakes	042579123490	RS15	14/14	National

Wooden Tree Stake Kit

This kit includes everything needed to support one newly transplanted tree, or any tree that needs protective support from winds and storms. Your tree grows straight and natural. Unique non-girdling strap with brass grommets. 3 easy to drive into ground, pencil-pointed hardwood 32" stakes. 33 ft of safe and easy-to-use professional tree rope.



Item #	Desc	UPC	Vendor	CS/UOS	Location
80010003	Tree Stake Kit	042579130009	PSS	12/12	National

Silt Fence

Silt Fence is commonly used fabric for erosion control in residential and commercial construction. Made of woven polypropylene yarns, it is designed to block the sediment while letting the water slowly flow through the fabric. Includes 11ea - 48" oak stakes.



Item #	Desc	UPC	Vendor	CS/UOS	Location
80010537	3'x100'	042579813735	SILTFENCE36	1/1	West

N-Sulate

DeWitt N-Sulate 1.5 oz is a permeable, UV-treated fabric designed to protect flowering annuals, bedding plants and vegetables from the severe cold and freezing temperatures. N-Sulate can lengthen your harvest time and extend your flowering season.



Item #	Desc	UPC	Vendor	CS/UOS	Location
80010033	12'x10'	042579123520	NS12	6/6	National



Super Steel Stakes

Green PE plastic coated plant stakes with a steel core. Pointed, ribbed, and rustproof with water tight closures on both ends, won't rot or split. Weatherproof and light weight for indoor or outdoor use. Spurs on stake provide easy tying and prevent vine slip down.



Item #	Desc	UPC	Vendor	CS/UOS	Location
82730072	2ft	760249614542	6131	20/20	National
82730073	3ft	760249614559	6132	20/20	National
82730074	4ft	760249614566	6133	20/20	National
82730075	5ft	760249614573	6134	20/20	National
82730076	6ft	760249614580	6135	20/20	National
82730077	6ft Heavy Duty	760249614597	6136	20/20	National
82730078	7ft Heavy Duty	760249614603	6137	10/10	National
82730079	8ft Heavy Duty	760249614610	6138	10/10	National

Hardwood Stakes

Kiln dried for straight stakes. Hardwood for extreme durability. Sharpened points.



Item #	Desc	UPC	Vendor	CS/UOS	Location
82730080	2 ft. x 1/2 in. x 1/2 in.	760249614627	6141	10/10	National
82730082	4 ft. x 3/4 in. x 3/4 in.	760249614641	6143	6/6	National
82730083	5 ft. x 3/4 in. x 3/4 in.	760249614658	6144	6/6	National
82730084	6 ft. x 3/4 in. x 3/4 in.	760249614665	6145	6/6	National

Green Bamboo Stakes

Green dyed to blend in with foliage. For use in gardens or containers. Lightweight and easy to stake in ground. 2ft-3ft-4ft (25-stakes per retail bag- 25 bags per case) 5ft-6ft (6-stakes per retail bag- 40 bags per case)



Item #	Desc	UPC	Vendor	CS/UOS	Location
82730085	2ft	760249614672	6161	25/25	National
82730086	3ft	760249614689	6162	25/25	National
82730087	4ft	760249614696	6163	25/25	National
82730089	5ft	760249614719	6165	40/40	National
82730090	6ft	760249614726	6166	40/40	National



Tree Stake Kit

Tree stake kit contains 3 notched, pointed hardwood stakes, 3 10" poly straps and 30' of galvanized wire. Everything you need to protect your younger tree from wind and storm damage.



Item #	Desc	UPC	Vendor	CS/UOS	Location
80470060	Tree Stake Kit	019263262100	2621	12/12	National

Aglok & Prolock Chain Ties

Designed for attaching support stakes to trees larger than 2 in. diameter. Chain ties are great for holding plants to trellises, arbors, lattice or other structures. Lightweight and strong, chain ties are made from durable high-density polyethylene and are easy to use over and over again.



Item #	Desc	UPC	Vendor	CS/UOS	Location
80470066	Prolock 1" X 100'	019263261905	2619	10/10	National
80470064	Aglok 1/2" X 150'	019263261707	2617	20/20	National

Jute Twine

Secure plants, designate rows in a garden or use for gift packages, scrapbooks, cards and more. Spool length is 219'.



Item #	Desc	UPC	Vendor	CS/UOS	Location
80470126	Natural 219 ft.	019263263008	2630	24/24	National
80470127	Green 219 ft.	019263263107	2631	24/24	National

Coated Paper Tree Wrap

Tree wrap protects from insects and heat scold. Easy to use coated paper that will not girdle tree bark.



Item #	Desc	UPC	Vendor	CS/UOS	Location
80470171	3"x50'	050699003035	300303	24/24	National

Garden Hardwood Stakes

Pencil pointed, high-quality 1"x1" stakes from North American hardwoods (Oak, Cherry and Maple) used to support and protect weaker plants or mark separate rows of plants. Banded into bundles for easy handling and retailing. Pricing is based on eaches



Item #	Desc	UPC	Vendor	CS/UOS	Location
80470112	3'x1"x1"	019263255102	2551	25/25	East
80470113	4'x1"x1"	019263255201	2552	25/25	East
80470114	5'x1"x1"	019263255300	2553	25/25	East
80470115	6'x1"x1"	019263255409	2554	25/25	East
80470116	7'x1"x1"	019263255508	2555	25/25	National

Weed Guard Woven Poly Landscape Fabric

9 pack retail ready rolls of weed barrier fabric 3' x 50'



Item #	Desc	UPC	Vendor	CS/UOS	Location
80470010	3'X 50'	019263252804	2528	9/9	National

Medium Weight Burlap Pac

The original packaged burlap in a colorful see-through package. First quality (selvaged both sides), medium-weave, 7 oz. burlap for decorating, crafts, gardening or any other odd jobs around the house. Especially useful for winter protection of valuable evergreen shrubs and bushes.



Item #	Desc	UPC	Vendor	CS/UOS	Location
80470001	3'x9'	019263257502	2575	16/16	National
80470002	3'x12'	019263257601	2576	12/12	National
80470003	3'x 24'	019263257700	2577	9/9	National
80470004	3'x48'	019263257809	2578	5/5	National



RapiClip® Tomato Plant Twine (A)

Natural 2-ply jute. Excellent for supporting tomato plants.

Item #	Desc	UPC	Vendor	CS/UOS	Location
80140018	800'	035307008756	875	12/12	National

RapiClip® Stretchy Nylon Tomato Ties (B)

These Tomato ties are soft, stretchy nylon ties for delicate plants.

Item #	Desc	UPC	Vendor	CS/UOS	Location
80140014	8 Pack	035307008296	829	12/12	National

Foam Wire Tie (C)

RapiClip Foam & Wire Twist Tie - Plant foam wire tie. Ideal for connecting plants and stems to supports. Features 1mm galvanized garden wire wrapped with 7mm foam.

Item #	Desc	UPC	Vendor	CS/UOS	Location
80140070	32.5'	035307008350	835	12/12	National

RapiClip® Vinyl Stretch Tie (D)

Plastic coated wire in holder with cutter.

Item #	Desc	UPC	Vendor	CS/UOS	Location
80140074	1/2" x 150'	035307008442	844	12/12	National
80140075	1" x 150'	035307008459	845	12/12	National

Twine in Dispenser Can

Perfect for dozens of uses around the house and garden. It is great for fastening, training and support in the yard and garden. Suitable for delicate tasks including securing clematis vines to a trellis, and rough tasks such as securing cords and hoses.



Item #	Desc	UPC	Vendor	CS/UOS	Location
80140085	Natural	035307004024	402	12/12	National
80140086	Green	035307004048	404	12/12	National

RapiClip® Plant Twist Ties (E)

0.4mm galvanized wire coated in plastic.

Item #	Desc	UPC	Vendor	CS/UOS	Location
80140077	8" - 100 pk	035307008480	848	12/12	National

RapiClip® Light Duty Garden Wire (F)

Green vinyl coated wire.

Item #	Desc	UPC	Vendor	CS/UOS	Location
80140072	164' Light Duty	035307008381	838	12/12	National

Heavy Duty Garden Wire (G)

Heavy duty garden wire for all yard and garden jobs. 50' roll and carded, with weather-resistant packing.

Item #	Desc	UPC	Vendor	CS/UOS	Location
80140069	50'	035307008343	834	12/12	National

RapiClip® 16' Soft Wire Tie (H)

Multi-purpose cushioned wire tie for countless home and garden uses. Great for supporting saplings and young or recently transplanted trees.

Item #	Desc	UPC	Vendor	CS/UOS	Location
80140163	Brown	035307008596	859	12/12	National
80140015	Green	035307008398	839	12/12	National
80140016	Green Heavy Duty	035307008572	857	12/12	National

RapiClip® Heavy Duty Garden Twine

Heavy duty, 3- ply jute twine for plant support. 200'



Item #	Desc	UPC	Vendor	CS/UOS	Location
80140017	Natural	035307008749	874	12/12	National
80140019	Green	035307008770	877	12/12	National



Rapiclip® Tomato Clips

Easily clip plants to stakes and wires.



Item #	Desc	UPC	Vendor	CS/UOS	Location
80140013	15 Pack	035307008190	819	12/12	National

Rapiclip® Plant Clips

These Twist and Clips will clip plants to canes and wires.



Item #	Desc	UPC	Vendor	CS/UOS	Location
80140067	15 Pack	035307008084	808	12/12	National

Rapiclip® Vine & Veggie Trellis Net

Green textile trellis net that provides support to vines and vegetable plants.



Item #	Desc	UPC	Vendor	CS/UOS	Location
80140080	5'x10'	035307008640	864	12/12	National

Rapiclip® Plant Twist Tie

Plastic coated wire in holder with cutter.



Item #	Desc	UPC	Vendor	CS/UOS	Location
80140073	100'	035307008411	841	12/12	National
80140076	164'	035307008466	846	12/12	National

Soft Wire Tie Strips

Light duty, 8" pre-cut soft wire ties. 20 per retail pack. 12 packs per case.



Item #	Desc	UPC	Vendor	CS/UOS	Location
80140081	Tie Strips	0353078657	865	12/12	National

Rapiclip® Plant Clips

Stretchy material expands with the growth of plant or tree. Convenient ball keeps product wound and secure. Each package contains 20 soft stretch ties 4MMX100'.



Item #	Desc	UPC	Vendor	CS/UOS	Location
80140200	4MMX100'	035307908681	868	10/10	National

Garden Twine

Jute Twine products from Rapiclip offer a natural, biodegradable and compostable option for tying up plants, or anything around the home.



Item #	Desc	UPC	Vendor	CS/UOS	Location
80140088	400' Green Twine	035307008787	878	12/12	National

Colored Plant Labels

Keep your garden organized with Rapiclip Colored Plant Labels 5 inch. This essential gardening tool ensures you never forget what you've planted. 5" labels - 30 labels per pack - ten of each color, yellow, green and blue.



Item #	Desc	UPC	Vendor	CS/UOS	Location
80140104	5"	035307908681	828	12/12	West





Double Flower Supports

This double peony flower support is perfect support for peonies and other flowering plants. Vinyl coated steel supports.



Item #	Desc	UPC	Vendor	CS/UOS	Location
80140135	18"x36"	035307009784	978	12/12	National

Single Flower Supports

This single flower support is perfect support for your plants. Three vinyl coated steel support legs.



Item #	Desc	UPC	Vendor	CS/UOS	Location
80140203	10"x18"	035307009678	967	12/12	National
80140134	14"x24"	00353079777	977	12/12	National
80140141	18"x30"	035307009876	987	12/12	National

Connecting Stakes

Plant Supports offer a full range of vinyl-coated items to keep almost any plant supported. 13"x30".



Item #	Desc	UPC	Vendor	CS/UOS	Location
80140121	3 Pack	035307009142	914	12/12	National

Link-Ups U-Support

For use with annuals or perennials. Helps protect from wind or rain damage. May be used season after season. Great for single stem or bushy plants.



Item #	Desc	UPC	Vendor	CS/UOS	Location
80140144	4"x15"	035307010209	1020	12/12	National
80140145	6"x17"	035307010254	1025	12/12	National
80140146	8"x22"	035307010308	1030	24/24	National
80140147	10"x30"	035307010353	1035	24/24	National
80140148	12"x34"	035307010407	1040	24/24	National
80140149	15"x30"	035307010452	1045	24/24	National
80140150	16"x40"	035307010506	1050	24/24	National

Rectangular Grow Through Grid

These supports allow you to contain your plants the way you want them, keeping your backyard neat, tidy and beautiful. Simply attach the legs, push into the ground and let the plant grow through. It is great for supporting beautiful heavy peony blooms, begonias, and tomatoes. They are sturdy and heavy enough to hold up for many years.



Item #	Desc	UPC	Vendor	CS/UOS	Location
80140127	24"x18"	035307009166	970	12/12	West

Gathering Rings

This gathering ring is easy to open and close to accept one or more taller stems. Vinyl coated steel.

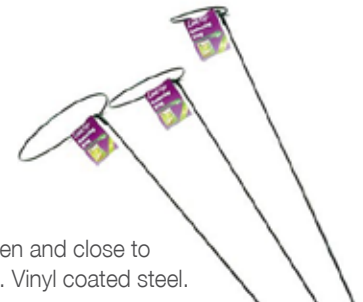

Item #	Desc	UPC	Vendor	CS/UOS	Location
80140123	6"x36"	035307009166	916	24/24	National

Round Grow Through Grids

Keep almost any plant protected and within bounds. Vinyl coated.



Item #	Desc	UPC	Vendor	CS/UOS	Location
80140128	12"x18"	035307009715	971	12/12	National
80140129	16"x24"	035307009722	972	12/12	National
80140130	20"x30"	035307009739	973	12/12	National

Flower Support & Plant Props

Help to support your flower garden stems with these vinyl coated steel plant stakes.



Item #	Desc	UPC	Vendor	CS/UOS	Location
80140136	2"x24"	035307009791	979	72/72	National
80140137	2"x36"	035307009807	980	48/48	National
80140140	3"x44"	035307009852	985	24/24	National

Mossify™

Bendable Coir Pole™

This unique plant support system is just what tropical plants have been craving for. Handcrafted with premium Manila rope, our Bendable Coir Pole™ is not only flexible and easy to use, but it's also perfect for all climbing, vining, and trailing plants. What sets our Bendable Coir Pole™ apart from the Bendable Moss Pole™ is that it's thinner and more pliable, making it the perfect support for a wide variety of plant sizes and shapes.



Item #	Desc	UPC	Vendor	CS/UOS	Location
82370004	16"	676307771082	BCP-0016	12/12	National
82370005	30"	676307771099	BCP-0030	12/12	National
82370006	42"	676307771105	BCP-0042	12/12	National

2025

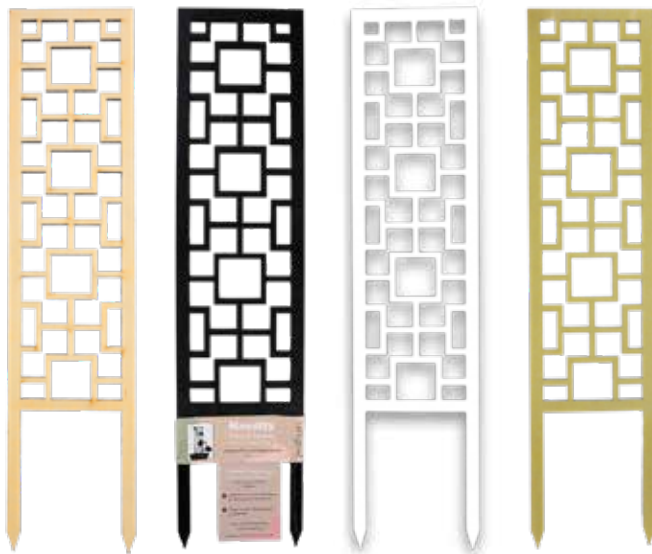

Tropical Squares Wooden Trellis

The Tropical Squares Wooden Trellis is crafted from high-quality Canadian Maple wood to ensure durability and longevity while maintaining a minimalist look. This fashionable trellis not only supports your plants but also adds a touch of sophistication to your indoor garden, enhancing the overall aesthetic of your space.
 Regular size: 17" high x 4" wide x 0.25" thick
 Mega size: 47.25" high x 10.25" wide x 0.47" thick

Item #	Desc	UPC	Vendor	CS/UOS	Location
82370012	Natural	639114714819	WTRLS-N-TS-0001	12/12	National
82370116	MEGA Natural	660111997837	WTRLS-N-TS-0002	1/1	National
82370013	Black	639114714826	WTRLS-B-TS-0001	12/12	National
82370118	MEGA Black	660111997868	WTRLS-B-TS-0002	1/1	National
82370014	White	639114714833	WTRLS-W-TS-0001	12/12	National
82370015	Gold	639114714840	WTRLS-G-TS-0001	12/12	National



The Bendable Moss Pole™

The Original Bendable Moss Pole™ by Mossify is a groundbreaking and award-winning moss pole that's revolutionizing the way customers support the growth of their tropical plants. Unlike traditional, rigid moss poles that dictate the direction of your plant's growth, Mossify's Bendable Moss Pole™ is designed to be flexible and adaptable, allowing plants to grow at their own natural pace and in any direction they please.

Item #	Desc	UPC	Vendor	CS/UOS	Location
82370057	3-pack 16" Thin	660111997318	BMPTN-3016	12/12	National
82370058	3-pack 30" Thin	660111997325	BMPTN-3030	12/12	National
82370002	30"	716252512269	BMP-0030	12/12	National
82370059	3-pack 42" Thin	660111997332	BMPTN-3042	12/12	National
82370003	42"	716252512276	BMP-0042	12/12	National

Mossify®



Heart Metal Trellis

Our "Give Love" Heart Metal Trellis is the perfect gift for the plant lover in your life. It's not just a functional piece for their favourite plants, but also a token of your love and affection. The delicate design makes it a beautiful display for any room. Use our metal trellis to add different levels to your plant! Perfect support for climbing plants, vining plants or trailing plants!

Item #	Desc	UPC	Vendor	CS/UOS	Location
82370044	11.75"x 18"	660111996977	MTRLS-B-HRT-001	12/12	National

Reusable Plant Tape

Mossify Plant Tape is the ideal solution for gently securing and training your plants as they grow with their Bendable Moss Poles or Bendable Coir Poles. This innovative and versatile plant tape is designed to blend seamlessly with your indoor garden, featuring a subtle green color that won't detract from the beauty of your plants.



Item #	Desc	UPC	Vendor	CS/UOS	Location
82370008	10'	639114714802	PLNTTP-0010	12/12	National



Totem Pole Plant Support

The ideal support for all indoor climbing plants. The frame is constructed of heavy gauge steel wire for ease in placing in existing potted plants with no damage to plant roots. Completely assembled; ready to use. The nylon sock is filled with long-fibered sphagnum moss allowing this unique pole to be moistened to encourage plants to cling to the pole. Seven fastening pins are included to assist fastening plants.

Item #	Desc	UPC	Vendor	CS/UOS	Location
80130056	24"	010367010109	ML1010	12/12	East
80130067	24" Display pack	010367010109	ML1010 12 DISPLAY	12/12	East
80130057	30"	010367010208	ML1020	12/12	East

PANACEA®

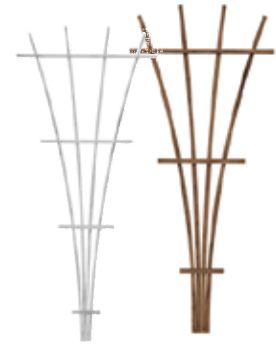

Wooden Fan Trellis

100% Wood. Available in brown and white. Two sizes.

Item #	Desc	UPC	Vendor	CS/UOS	Location
80161249	Brown 48"	093432837375	83737	6/6	East
80161245	Brown 72"	093432824252	82425	6/6	East
80161247	White 72"	093432837351	83735	6/6	East

Wooden Ladder Trellis

100% Wood. Available in brown and white.

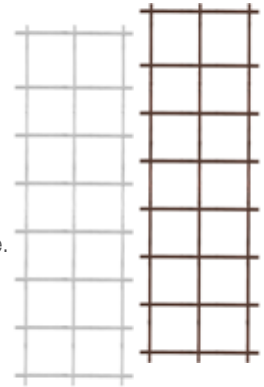

Item #	Desc	UPC	Vendor	CS/UOS	Location
80161246	Brown 72"	093432824269	82426	6/6	East
80161248	White 72"	093432837368	83736	6/6	East

Green Fan Pot Trellis

This trellis plant support spreads outward from a narrow base as it extends upward to a height of 36". Perfect for small climbing plants and use within a pot of 5" diameter or more.

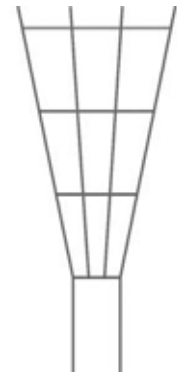

Item #	Desc	UPC	Vendor	CS/UOS	Location
80160444	36"	093432896358	89635	12/12	National

Plant Support

PVC coated Galvanized wire construction. Green - 2" ring, 36" Leg. Train the leaves or stem to twist around the stake for added effect and support.



Item #	Desc	UPC	Vendor	CS/UOS	Location
80160043	36"	093432893401	89340	24/24	National



42" Tomato Cages

Supports tomato plants, climbing vines, as well as bushy top heavy plants and flowers 42"x14" diameter 3 rings x 3 legs.

Item #	Desc	UPC	Vendor	CS/UOS	Location
80160513	Red	93432897713	89771	50/50	National
80160514	Green	93432897720	89772	50/50	National
80160515	Yellow	93432897737	89773	50/50	National
80160516	Blue	93432897744	89774	50/50	National

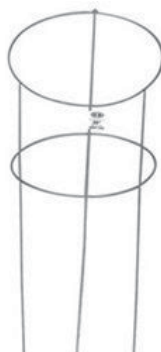

Double Peony Ring

Has 3 Legs, 2 Rings, 18" Top Ring x 30" High. Galvanized wire construction.

Item #	Desc	UPC	Vendor	CS/UOS	Location
80160063	18"	093432897201	89720	25/25	National



Metal Plant Stake

Plastic coated metal plant stake (11mm dia.) Green

Item #	Desc	UPC	Vendor	CS/UOS	Location
80160479	3'x11mm	093432897867	89786	50/50	National
80160480	5'x11mm	093432897874	89787	50/50	National
80160481	6'x11mm	093432897881	89788	50/50	National

Lightweight Triple Stalk Garden Edge

Protect your plants from foot traffic with this Panacea™ Lightweight Triple Stalk Garden Edge. Crafted of metal, this border is designed to be used for several seasons, and its black finish meshes with your setting. This fence section has three arches at the top, each with a vertical rod beneath it. 14" x 48" sections

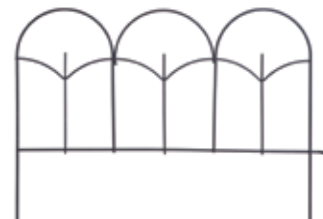

Item #	Desc	UPC	Vendor	CS/UOS	Location
80160387	14"X18"	093432893937	89393	24/24	West

Square Tomato Tower

Tomato plants and other tall top heavy plants will thrive on this durable plant support tower. Just unfold and create a square frame and push the four stabilizing legs into the ground. Cage can be installed after plant is mature.



Item #	Desc	UPC	Vendor	CS/UOS	Location
80160067	46"	093432897300	89730	25/25	National

Tomato Cages

Galvanized wire construction. Cages are PVC coated. Great for supporting peppers, eggplants and other tall garden and flowering plants too!



Item #	Desc	UPC	Vendor	CS/UOS	Location
80160064	33"x12"	093432897232	89723	25/25	National
80160065	42"x12"	093432897249	89724	25/25	National
80160066	54" 4 Leg	093432897263	89726	25/25	National
80160530	54" 4 Leg Heavy Duty	093432897393	89739	20/20	National
80160524	54" 3 Leg	093432897256	89725	25/25	National



Moss Poles

Moss Pole is a naturally absorbent support pole that helps aerial roots take hold and creates an ideal habitat for many climbing and upright plants. It's the next best thing to growing your plants in a forest! The SuperMoss Pole includes metal pins to easily secure the branches and foliage.



Item #	Desc	UPC	Vendor	CS/UOS	Location
80230831	24"	759834222101	22210	12/12	National
80230181	36"	759834222354	22235	12/12	National

Moss Stake

An elegant and natural way to support growing plants, especially orchids, these sustainable bamboo stakes are covered in the same high-quality green Mountain Moss as our other products. A great way to add natural elements to any potted plant or support top heavy blooms, these stakes come in a fresh green color and are available in a variety of sizes and quantities. Whether you're bringing new life to your living space, enriching your garden for spring, or designing a centerpiece for a special occasion, it all starts with heart.



Item #	Desc	UPC	Vendor	CS/UOS	Location
80230182	18" 6pk	759834220503	22050	12/12	National



Garden Stakes

Twenty coated steel garden stakes for building tomato cages, trellises, and other plant support structures.



Item #	Desc	UPC	Vendor	CS/UOS	Location
82110068	3ft		TDSS3	100/20	East
82110067	4ft		TDSS4	100/20	East
82110004	5ft	662578162650	TDSS5S	100/20	East
82110061	6ft	850033216165	TDSS6S	100/20	East



Hortonova Trellis Net

Tenax Hortonova Trellis Net is the most effective and economical way to support climbing vegetables and heavy crops. The net is a resistant but lightweight stretchable trellis between and over gardens, flower beds or hydroponic systems.



Item #	Desc	UPC	Vendor	CS/UOS	Location
81900105	79"x1500' white	010515403197	1A140319	1/1	National
81900089	79"x1000' white 5.9"x6.7" mesh	010515502838	1A150283	1/1	National
81900112	120"x1500' white 5.9"x6.7" mesh	010515703105	1A170310	1/1	National
81900113	120"x3280' white 5.9"x6.7" mesh	010515703112	1A170311	1/1	National
81900079	59"x3280' white 5.9"x6.7" mesh	010515125105	58012510US	1/1	National
81900090	79"x3280' white 5.9"x6.7" mesh	010515125136	58012513US	1/1	National
81900298	79"x3280' white 4"x4" mesh	010515200222	2A220022	1/1	National
81900065	36" x 3280' white 5.9"x5.9" mesh	010515366072	58036607US	1/1	National
81900076	48"x3280' white 5.9"x5.9" mesh	010515366096	58036609US	1/1	National
81900104	48"x1500' white 5.9"x5.9" mesh	010515403180	1A140318	1/1	National
81900081	67"x3280' white 5.9"x6.7" mesh	010515125112	58012511US	1/1	National
81900304	3"x3280' white 6"x6" mesh	010515400011	5A240001	1/1	National
81900305	60"x3280' white 3.5"x3.5" mesh	010515400035	1A240003	1/1	National



Green Tripod

Economically designed with flexible legs to easily insert into soil to form a growing pyramid for vining plants. As the plant grows, it naturally secures itself to small, fine protrusions on the three legs. Top of the tripod features a lug to clip on a label and is soft enough to prevent eye injury.



Item #	Desc	Vendor	CS/UOS	Location
82060092	18" Tripod	6900 7030 TR18	50/50	National
82060093	24" Tripod	6900 7130 TR24	50/50	National
82060094	32" Tripod	6900 7230 TR32	50/50	National

2025

Plastic Bamboo Trellis

This plastic trellis accents plants with its natural bamboo look. Designed to insert into potted soil. As the plant grows, roots grip onto the trellis base making it secure enough to be lifted by the top of the trellis for easy transport.



Item #	Desc	Vendor	CS/UOS	Location
82060088	28.75" TAN	6900 2720 PS16	50/50	National
82060089	21.5" TAN	6900 2727 PS17	50/50	National

Gro Triangle

Designed to hold three canes upright, creating a column. Sized for split or standard canes.



Item #	Desc	Vendor	CS/UOS	Location
82060081	Triangle Support	6900 3730 GRO-T2	100/100	East

Black Obelisk

Made to look like wrought iron. These obelisks have hook type grips on the bottom of their legs to achieve a secure hold in soil. Steps up the legs allow climbers to attach easily. Two pieces snap easily together.



Item #	Desc	Vendor	CS/UOS	Location
82060090	32"	3900 7480 OB2	25/25	National

In-Pot Cane Support

An economical way to reduce the mess and create more saleable items. Cane Supports are designed to grip and hold canes upright and steady in pots, helping to prevent damage to plants. Once the plant is rooted, the pot may be lifted by cane for transport.



Item #	Desc	Vendor	CS/UOS	Location
82060084	In-Pot Cane	6900 3180 CBS1	100/100	National

GGSPRO TECHNICAL TIPS!

Subscribe to our GGSPRO e-mail program and learn helpful tips and tricks to optimize your growing facility!

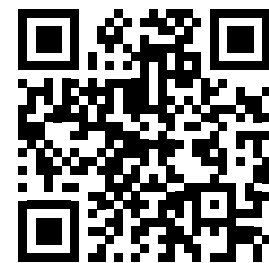

Visit www.griffins.com to subscribe!

POTS & PLANTERS

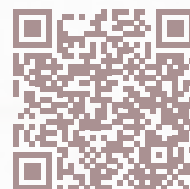

CHECK OUT OUR
CLEARANCE ITEMS!

DROP SHIP VENDORS

Classic Home & Garden

Contact your Griffin Sales Representative for a quote! FOB CT

Blue Sky Clayworks

\$300 min/\$100 re-order per shipping location
FOB Ontario, CA
Cannot mix product from different vendor catalogs to meet
min Offer free goods to help off set cost of freight

Jackson Pottery

\$2,500 min
Freight \$ 850.00 flat rate
Order at jacksonpottery.com



Griffin Greenhouse Retail WAREHOUSE Shipping Map

We are now shipping nationwide!

NATIONAL



2025

Refer to location key:

National items are stocked nationally
 Select items are sold East or West only; no exceptions

8" Kaleidoscope Planter

Premium plastic modular planter can be displayed individually each planter has a removable saucer ideal for succulents or shallow rooted planted.

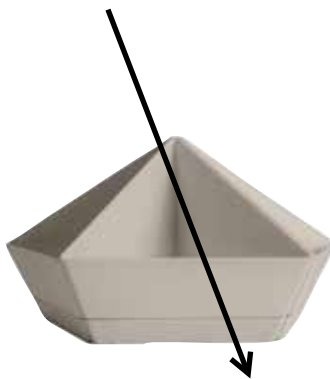

Item #	Desc	UPC	Vendor	CS/UOS	Location
80282643	Vanilla Bisque	770932844170	KDP08000A58	6/6	National

Where is the pricing?

1. Scan QR code on Chapter Pages to see pricing on Griffins.com
2. Contact your Griffin Sales Representative
3. Call into Griffin Customer Service 800.888.0054





Assorted Mini Air Planter

A unique and modern way to add foliage to any home or office, these planters are made from high quality ceramic and designed for ample air circulation. Great for both indoor and outdoor use. 2.5" x 2.5" *Air Plants not included*



Item #	Desc	UPC	Vendor	CS/UOS	Location
80690131	Black, White, Red	849637000379	AP07	15/15	East

Cone Air Planters

These cone-shaped hanging planters are a unique and stylish way to showcase your air plants, succulents, or cactus. Use the included metal wire to hang the planter from trees, brackets, or windows. They also make great bird feeders or can be used as tabletop décor. Designed using high-quality ceramic for indoor or outdoor use. 8.5"x5.25" *Succulents not included*



Item #	Desc	UPC	Vendor	CS/UOS	Location
80690870	Black	849637002946	AP05B	8/8	East
80690871	White	849637002953	AP05GW	8/8	East

Garden Bowl

Great for succulents, herbs, fairy gardens, and creative arrangements, these are attractive, eco-friendly containers made of recycled plastic, stone powder, and wood dust. Lightweight, durable, and weather resistant. Easy to drill for drainage. For indoor or outdoor use.



Item #	Desc	UPC	Vendor	CS/UOS	Location
80690368	8" Choc.	849637000560	M20C	12/12	East

Dragonfly Pot

The unique design of this dragonfly pot makes it a great decorative element. The durable, lightweight planter is made from a unique blend of recycled plastic, stone powder, and wood dust. Easy to drill for drainage. For indoor or outdoor use. Measures 13" x 11".



Item #	Desc	UPC	Vendor	CS/UOS	Location
80690420	Beige	897378002206	OF33B	6/6	East
80690422	Terra Cotta	813001010004	OF33TC	6/6	East

Solstice Round Hanging Basket

A part of our long-established Solstice Series collection for coconut planters, this hanging planter is a sure way to add style to your outdoor green space. The planter is weather-resistant and made from durable metal with a power-coated finish. It includes a secured coconut liner made from 100% natural coconut fibers. The liner helps retain moisture for promoting root growth while also providing sufficient drainage and air circulation.



Item #	Desc	UPC	Vendor	CS/UOS	Location
80690091	20"	813001015931	1593	5/5	East

Coco Liner

Made of natural coconut fiber, these liners retain moisture to promote root growth while providing sufficient drainage and air circulation.



Item #	Desc	UPC	Vendor	CS/UOS	Location
80690057	12" Round	813001015474	1547	15/15	East
80690611	12" Wall Manger	849637000966	CB51	10/10	East
80690058	14" Round	813001015481	1548	15/15	East
80690052	24" Trough	813001015405	1540	10/10	East
80690614	18" Round	849637000997	CB54	5/5	East
80690059	16" Round	813001015498	1549	15/15	East
80690060	20" Round	813001015542	1554	5/5	East



Plant Saucer

Made of recycled plastic, stone powder, and wood dust, position these attractive saucers under a planter or garden pot to catch excess water and protect your surfaces. For indoor or outdoor use.

Item #	Desc	UPC	Vendor	CS/UOS	Location
80690134	10" Chocolate	813001013074	AP25C	4/4	East
80690135	10" Dark Charcoal	813001013050	AP25DC	4/4	East
80690138	12" Chocolate	813001013036	AP30C	4/4	East
80690139	12" Dark Charcoal	813001013012	AP30DC	4/4	East
80690140	12" Terra Cotta	813001013005	AP30TC	4/4	East
80690143	14" Dark Charcoal	813001012978	AP35DC	4/4	East
80690144	14" Terra Cotta	813001012961	AP35TC	4/4	East



Deluxe Pedestal Urn

Arcadia Garden Products' Deluxe Pedestal Urns make a bold statement with a timeless, classic design. These plastic urns are an ideal statement piece for any entryway, living space, patio, or garden. Made of high-quality plastic material, the urns can compete against weather and UV-rays while still easy to relocate.



Item #	Desc	UPC	Vendor	CS/UOS	Location
80690838	10x17" Black	849637007064	PL50BK	2/2	East
80690839	10x17" White	846937007071	PL50WT	2/2	East
80690842	22x36" Black	846937007101	PL52BK	2/2	East

Traditional Whitewash Plastic Urn

Featuring a traditional design, these plastic urns are an ideal statement piece for any entrance way, living space, table centerpiece, or garden. The high-quality synthetic material creates a sturdy product that can compete against weather and UV-rays. The two-piece pedestal construction is a classic design that adds style to any décor.



Item #	Desc	UPC	Vendor	CS/UOS	Location
80690905	10x12"	849637006289	PL20WW	18/18	East
80690904	13x15"	849637006272	PL10WW	16/16	East
80690903	16x18"	849637006265	PL00WW	12/12	East

Bulb Pans

Ideal for daffodils, tulips, succulents, bonsai, and fairy gardens, these are attractive, eco-friendly containers made of recycled plastic, stone powder, and wood dust. Lightweight, durable, and weather resistant. Easy to drill for drainage. For indoor or outdoor use.



Item #	Desc	UPC	Vendor	CS/UOS	Location
80690720	A 10"x5" Taupe	849637004216	TD25TP	12/12	East
80690717	B 8"x3" Taupe	849637004278	TA20TP	12/12	East
80690718	B 10"x3.5" Taupe	849637004285	TA25TP	12/12	East
80690719	B 12"x5" Taupe	849637004292	TA30TP	12/12	East
80690466	8"x3" Dark Charcoal	813001010479	TA20DC	12/12	East
80690517	12"x5" Dark Charcoal	813001010530	TA30DC	12/12	East
80690467	8"x3" Terra Cotta	813001010486	TA20TC	12/12	East
80690518	12"x5" Terra Cotta	813001010547	TA30TC	12/12	East



Redwood Planter

This smooth natural redwood planter from A&G Agricultural Supply features rounded formal corners. It is smooth, sturdy, and hand made. Beautiful for outdoor plants.

Item #	Desc	UPC	Vendor	CS/UOS	Location
82620053	15"x14"x36"	604280015114	151436FP	1/1	West
82620054	15"x14"x48"	604280015121	151448FP	1/1	West
82620055	18"x18"x13"	604280015183	18181312FP	1/1	West

Redwood Window Box

This is perfect for any garden or landscape. Handmade from beautiful California redwood. Banded with stainless steel bands.



Item #	Desc	UPC	Vendor	CS/UOS	Location
82620056	2'	604280017026	2BWB	1/1	West
82620057	3'	604280017033	3BWB	1/1	West
82620058	4'	604280017040	4BWB	1/1	West



bloem



Ups-A-Daisy

Help your flowers and plants rise to the occasion. Ups-A-Daisy plant elevation platforms are uniquely designed to help reduce the amount of potting soil required to fill large, tapered pots. Ups-A-Daisy sets inside your planter approximately 1/2 to 2/3 of the way down into your container.

Item #	Desc	UPC	Vendor	CS/UOS	Location
80921849	10"	818573010001	T6320-6	6/6	National
80921247	12"	818573010025	T6322-6	6/6	National
80921249	14"	818573010049	T6324-6	6/6	National



BLOEM COLOR KEY



bloem

ARIANA PLANTER

Bell-shaped decorative planters |

With grid - For worry free watering

A self-watering insert built into the bottom of the planter traps excess water where the roots can access it, reducing the how often you need to water. It also helps prevent plant-killing root rot by allowing oxygen to access the plants roots. A range of traditional and vibrant color choices make it easy to coordinate with your home décor or add an eye-catching splash of color.

6" Ariana Planters

Item #	Desc	UPC	Vendor	CS/UOS	Location
80921362	6" Living Green	087404564062	20-56406	10/10	National
80921364	6" Chocolate	087404563065	20-56306CH	10/10	National
80921363	6" Terra Cotta	087404561061	20-56106	10/10	National
80921869	6" Charcoal	814174029602	AP06908	10/10	National
80922249	6" Merlot	087404004346	AP0657	10/10	National
80921866	6" Burnt Red	814174029305	AP0613	10/10	National
80922250	6" Pebble Stone	087404004384	AP0683	10/10	National
80922248	6" Muted Terra Cotta	087404004933	AP0647	10/10	National
80921354	6" Black	087404569067	20-56906	10/10	National
80922247	6" Misty Blue	087404004308	AP0637	10/10	National
80922441	6" Vanilla Bean	087404012464	AP0682	10/10	National
80922435	6" Daffodil	087404008658	AP0624	10/10	National
80922436	6" Dusty Rose	087404012433	AP0634	10/10	National
80922440	6" Navy	087404012457	AP0670	10/10	National
80922438	6" Charleston	087404012440	AP0653	10/10	National
80922437	6" Basil	087404008665	AP0641	10/10	National
80922439	6" Peppercorn	814174024737	AP0660	10/10	National

8" Ariana Planters

Item #	Desc	UPC	Vendor	CS/UOS	Location
80921374	8" Living Green	087404564086	20-56408	10/10	National
80921376	8" Chocolate	087404563089	20-56308CH	10/10	National
80921375	8" Terra Cotta	087404561085	20-56108	10/10	National
80921870	8" Burnt Red	814174029336	AP0813	10/10	National
80921873	8" Charcoal	814174029619	AP08908	10/10	National
80922253	8" Merlot	087404004353	AP0857	10/10	National
80922254	8" Pebble Stone	087404004391	AP0883	10/10	National
80922252	8" Muted Terra Cotta	087404004940	AP0847	10/10	National
80921366	8" Black	087404569081	20-56908	10/10	National
80922251	8" Misty Blue	087404004315	AP0837	10/10	National
80922444	8" Basil	087404008689	AP0841	10/10	National
80922446	8" Peppercorn	814174024775	AP0860	10/10	National
80922443	8" Dusty Rose	087404012471	AP0834	10/10	National

10" Ariana Planters

Item #	Desc	UPC	Vendor	CS/UOS	Location
80921386	10" Living Green	087404564109	20-56410	10/10	National
80921388	10" Chocolate	087404563102	20-56310CH	10/10	National
80921387	10" Terra Cotta	087404561108	20-56110	10/10	National
80921874	10" Burnt Red	814174029367	AP1013	10/10	National
80921877	10" Charcoal	814174029626	AP10908	10/10	National
80922257	10" Merlot	087404004360	AP1057	10/10	National
80922258	10" Pebble Stone	087404004407	AP1083	10/10	National
80922256	10" Muted Terra Cotta	087404004957	AP1047	10/10	National
80921378	10" Black	087404569104	20-56910	10/10	National
80922255	10" Misty Blue	087404004322	AP1037	10/10	National
80922451	10" Basil	087404008702	AP1041	10/10	National

12" Ariana Planters

Item #	Desc	UPC	Vendor	CS/UOS	Location
80921398	12" Living Green	087404564123	20-56412	10/10	National
80921400	12" Chocolate	087404563126	20-56312CH	10/10	National
80921399	12" Terra Cotta	087404561122	20-56112	10/10	National
80921878	12" Burnt Red	814174029398	AP1213	10/10	National
80922261	12" Merlot	087404004377	AP1257	10/10	National
80921881	12" Charcoal	814174029633	AP12908	10/10	National
80922262	12" Pebble Stone	087404004414	AP1283	10/10	National
80922260	12" Muted Terra Cotta	087404004964	AP1247	10/10	National
80921390	12" Black	087404569128	20-56912	10/10	National
80922458	12" Basil	087404008726	AP1241	10/10	National
80922460	12" Peppercorn	814174024850	AP1260	10/10	National

16" & 20" Ariana Planters

Item #	Desc	UPC	Vendor	CS/UOS	Location
80921410	16" Living Green	087404564161	20-56416	6/6	National
80921412	16" Chocolate	087404563164	20-56316CH	6/6	National
80921411	16" Terra Cotta	087404561160	20-56116	6/6	National
80921422	20" Living Green	087404564208	20-56420	6/6	National
80921424	20" Chocolate	087404563201	20-56320CH	6/6	National
80921423	20"-Terra Cotta	087404561207	20-56120	6/6	National





Terra Cotta



Pebble Stone



Charcoal



Black



Living Green



Muted Terra Cotta



Misty Blue



Casper White



Chocolate

bloem

Dura Cotta Window Box

Made from durable polypropylene. Plastic outdoor planters offer affordable beauty without heavy weight or risk of breakage.

Window box includes attached drainage tray and cross support piece.



Item #	Desc	UPC	Vendor	CS/UOS	Location
80920719	18" Terra Cotta	811214020087	DCBT18-46	12/12	National
80921932	18" Charcoal	087404000348	DCBT18-908	12/12	National
80920718	18" Living Green	811214020070	DCBT18-42	12/12	National
80921527	18" Chocolate	814174024355	DCBT18-45	12/12	National
80920724	18" Black	811214020131	DCBT18-00	12/12	East
80920725	24" Living Green	811214020148	DCBT24-42	12/12	National
80920726	24" Terra Cotta	811214020155	DCBT24-46	12/12	National
80921934	24" Charcoal	087404000362	DCBT24-908	12/12	National
80920732	30" Living Green	811214020216	DCBT30-42	12/12	National
80920733	30" Terra Cotta	811214020223	DCBT30-46	12/12	National
80921936	30" Charcoal	087404000386	DCBT30-908	12/12	National



Terrapot Planter & Bowl

Add a touch of color to your garden or home with this charming Bloem Terra Pot Planter. Inspired by the look of clay planters but constructed of a durable polypropylene material, enabling years of functionality and reliable use.

Item #	Desc	UPC	Vendor	CS/UOS	Location
PLANTER					
80921536	4" Terra Cotta	087404500046	20-50004C	20/20	National
80921535	4" Living Green	814174026373	TR0442	20/20	National
80921537	4" Chocolate	814174026380	TR0445	20/20	National
80922104	4" Charcoal	087404000935	TR04908	20/20	National
80921541	6" Terra Cotta	087404500060	50006C	20/20	National
80921540	6" Living Green	087404504068	50406	20/20	National
80921542	6" Chocolate	087404500657	450065-1001	20/20	National
80922107	6" Charcoal	087404000966	TR06908	20/20	National
80921546	8" Terra Cotta	087404500084	50008C	20/20	National
80921545	8" Living Green	087404504082	20-50408	20/20	National
80921547	8" Chocolate	087404500855	450085-1001	20/20	National
80922110	8" Charcoal	087404000997	TR08908	20/20	National
80921551	10" Terra Cotta	087404500107	50010C	20/20	National
80921552	10" Chocolate	087404501050	450105-1001	20/20	National
80922113	10" Charcoal	087404001024	TR10908	20/20	National
80921769	10" Living Green	087404504105	50410	20/20	National
80921556	12" Terra Cotta	087404500121	50012C	10/10	National
80921557	12" Chocolate	087404503122	50312CH	10/10	National
80922116	12" Charcoal	087404001055	TR12908	10/10	National
80922115	12" Pebble Stone	087404001048	TR1283	10/10	National
80921562	14" Chocolate	087404503146	20-50314CH	10/10	National
80921561	14" Terra Cotta	087404500145	50014C	10/10	National
80922118	14" Pebble Stone	087404001079	TR1483	10/10	National
80921566	16" Terra Cotta	087404500169	50016C	10/10	National
80921568	16" Chocolate	087404503160	50316CH	10/10	National
80921571	20" Terra Cotta	087404500206	50020C	10/10	National
BOWL					
80921828	14" Terra Cotta	087404540141	54014C	10/10	East

Mathers Planters

The Mathers planter was designed to be both simple and sophisticated. This planter is great for indoor and outdoor planting. Planters feature predrilled drainage holes and attached snap on saucer to protect surfaces. Great for foliage and flower drop ins!



Item #	Desc	UPC	Vendor	CS/UOS	Location
80922300	6" Muted Terra Cotta	087404005404	MAT0647	4/4	National
80922299	6" Misty Blue	087404005398	MAT0637	4/4	National
80922301	6" Pebble Stone	087404004483	MAT0683	4/4	National
80922304	8" Muted Terra Cotta	087404005428	MAT0847	4/4	National
80922303	8" Misty Blue	087404004704	MAT0837	4/4	National
80922305	8" Pebble Stone	087404004490	MAT0883	4/4	National
80922308	10" Muted Terra Cotta	087404005435	MAT1047	4/4	National
80922309	10" Pebble Stone	087404004735	MAT1083	4/4	National
80922307	10" Misty Blue	087404004728	MAT1037	4/4	National



Charcoal



Black



Bermuda Teal



Burnt Red



Earthy Yellow



Classic Blue



Royal Lilac



Fuchsia



Mango



Mint Green

bloem

SATURN PLANTER

Durable construction – won't fade, chip, or crack |

Includes matching saucer

Add a touch of modern elegance to your garden or home with this charming Bloem Saturn planter. It is crafted from polypropylene, so it is durable and can be used both inside or outside no matter the weather. The design features natural textures and decorative embellishments to add a beautiful accent to your home.

5" Saturn Planters

Item #	Desc	UPC	Vendor	CS/UOS	Location
80922060	5" Charcoal	814174029459	SP05908	12/12	National
80921306	5" Black	814174023051	SP0500	12/12	National
80922057	5" Bermuda Teal	087404000737	SP0526	12/12	National
80922055	5" Burnt Red	087404000713	SP0513	12/12	National
80922056	5" Earthy Yellow	087404000720	SP0523	12/12	National
80922218	5" Classic Blue	087404003486	SP0533	12/12	National
80922602	5" Royal Lilac	087404013379	SP05928	12/12	National
80922599	5" Fuchsia	087404013348	SP0515	12/12	National
80922600	5" Mango	087404013355	SP0519	12/12	National
80922601	5" Mint Green	087404013362	SP0536	12/12	National

7" Saturn Planters

Item #	Desc	UPC	Vendor	CS/UOS	Location
80922066	7" Charcoal	814174029480	SP07908	12/12	National
80921313	7" Black	814174023105	SP0700	12/12	National
80922063	7" Bermuda Teal	087404000768	SP0726	12/12	National
80922061	7" Burnt Red	087404000744	SP0713	12/12	National
80922062	7" Earthy Yellow	087404000751	SP0723	12/12	National
80922219	7" Classic Blue	087404003493	SP0733	12/12	National
80922606	7" Royal Lilac	087404013416	SP07928	12/12	National
80922603	7" Fuchsia	087404013386	SP0715	12/12	National
80922604	7" Mango	087404013393	SP0719	12/12	National
80922605	7" Mint Green	087404013409	SP0736	12/12	National



10" Saturn Planters

Item #	Desc	UPC	Vendor	CS/UOS	Location
80922072	10" Charcoal	814174029510	SP10908	6/6	National
80921320	10" Black	814174023150	SP1000	6/6	National
80922069	10" Bermuda Teal	087404000799	SP1026	6/6	National
80922067	10" Burnt Red	087404000775	SP1013	6/6	National
80922068	10" Earthy Yellow	087404000782	SP1023	6/6	National
80922220	10" Classic Blue	087404003509	SP1033	6/6	National
80922607	10" Fuchsia	087404013225	SP1015	6/6	National
80922608	10" Mango	087404013232	SP1019	6/6	National
0922609	10" Mint Green	087404013249	SP1036	6/6	National

12" Saturn Planters

Item #	Desc	UPC	Vendor	CS/UOS	Location
80922078	12" Charcoal	814174029541	SP12908	6/6	National
80921327	12" Black	814174023204	SP1200	6/6	National
80922075	12" Bermuda Teal	087404000829	SP1226	6/6	National
80922073	12" Burnt Red	087404000805	SP1213	6/6	National
80922074	12" Earthy Yellow	087404000812	SP1223	6/6	National
80922221	12" Classic Blue	087404003516	SP1233	6/6	National
80922611	12" Fuchsia	087404013263	SP1215	6/6	National
80922612	12" Mango	087404013270	SP1219	6/6	National
80922613	12" Mint Green	087404013287	SP1236	6/6	National



bloem

Deck Rail Planter

This planter is great for home and apartment use and helps you make the most of your porch or patio living space. Compression design ensures a secure fit on either a 4" or 6" wide rail with drainage holes. Features a tiered bottom design allowing dirt and roots to grow strong and deep.



Item #	Desc	UPC	Vendor	CS/UOS	Location
80921274	12" Terra Cotta	087404771217	477121-1001	10/10	National
80922273	12" Charcoal	087404005367	DR12908	10/10	National
80921276	24" Terra Cotta	087404477249	477241-1001	10/10	National
80921277	24" Chocolate	087404772450	477245-1001	10/10	National
80922242	24" Charcoal	087404003028	DR24908	10/10	National

Finley Rail Planter

Made of 100% recycled plastic. These planters feature punch out holes to allow water to drain freely. Deck rail fits a standard 2x4 or 2x6 railing. 9.5" H x 11.74" W x 23.99" D



Item #	Desc	UPC	Vendor	CS/UOS	Location
80922332	24" Black	087404006098	FDR2400	6/6	National
80922333	24" Casper White	087404006104	FDR2409	6/6	National
80922334	24" Charcoal	087404006111	FDR24909	6/6	East

Grecian Urn

A perfect transition from classic Greece to America's Garden Scene. The Grecian series combines the natural look of stone with the durability and economy of polypropylene. Perfect on a patio, porch or deck.



Item #	Desc	UPC	Vendor	CS/UOS	Location
80920755	12" Black	811214020445	GU12-00	12/12	National
80921956	12" Charcoal	814174029756	GU12-908	12/12	National
80920761	18" Black	811214020506	GU18-00	6/6	National
80921958	18" Casper White	814174029763	GU18-09	6/6	National
80921960	18" Charcoal	814174029770	GU18-908	6/6	National

Tuxton Planters

This unique geometric garden pot has a strong modern look. Designed to easily just drop-in plantings and works great with succulents and herbs. The pot is made of high-quality durable material which ensures that pot wont fade if placed in the sun. Very clean and resistant to extreme weather. No drainage



Item #	Desc	UPC	Vendor	CS/UOS	Location
80922314	6" Casper White	087404004995	TXT0609	6/6	East
80922315	6" Charcoal	087404005008	TXT06908	6/6	East
80922316	8" Casper White	087404005015	TXT0809	6/6	East
80922317	8" Charcoal	087404005022	TXT08908	6/6	East
80922318	10" Casper White	087404005039	TXT1009	6/6	East
80922319	10" Charcoal	087404005046	TXT10908	6/6	East

Finley Tall Square Planter

Made out of 100% recycled plastic, these planters feature punch out holes to allow water to drain freely and prevent root rot. From front door statements to back deck decor these impress.



Item #	Desc	UPC	Vendor	CS/UOS	Location
80922293	20" Casper White	087404005374	FPS2009-6	6/6	National
80922292	20" Black	087404004285	FPS2000-6	6/6	National
80922330	25" Casper White	087404006074	FPS2509-2	4/4	National
80922329	25" Black	087404006067	FPS2500-2	4/4	National

Finley Tall Round Planter

Made out of 100% recycled plastic, these planters feature punch out holes to allow water to drain freely and prevent root rot. From front door statements to back deck decor these modern and stylish planters are sure to impress.



Item #	Desc	UPC	Vendor	CS/UOS	Location
80922326	14" Black	087404006036	FPR1400	4/4	East
80922327	14" Casper White	087404006043	FPR1409	4/4	East



bloem

Grecian Pedestal Urn

Quality urn made of polypropylene. 100% UV stable and weather resistant. Safe to leave out all winter long and will hold up for many years in the strongest sun. Measures 32" tall and 18" diam.



Item #	Desc	UPC	Vendor	CS/UOS	Location
80920767	18" Black	811214020568	GU180-00	4/4	National
80921957	18" Casper White	814174029787	GU180-09	4/4	National
80921959	18" Charcoal	814174029794	GU180-908	4/4	National

Veranda Square Plastic Deck Box Planter

The Bloem Veranda Deck Box Planter offers a rolled lip wide opening and ample soil space to accommodate several grower pots. It will last season after season since it's fade-resistant and made from durable polyethylene plastic. This traditional looking and lightweight pot is ideal for decks, entryways, and outdoor living spaces due to its legs that prevent mold or mildew from collecting at the bottom.



Item #	Desc	UPC	Vendor	CS/UOS	Location
80922136	14" Charcoal	087404001437	VER14908	5/5	National

RailScapes

RailScapes is now available for wholesale! This floating clip provides a tool-free installation on various railings, including metal, wood, and vinyl, making it suitable for both indoor and outdoor spaces. To install simply hook and flex the anchors between spindles. The anti-slip/anti-scratch bumpers hold it in position without leaving a mark.



Item #	Desc	UPC	Vendor	CS/UOS	Location
80922431	12 Pack	087404001437	RST1-12	12/12	National

Terra Saucer

The Bloem Terra Saucer in Terra Cotta is a quintessential addition to your planting tools for both functionality and style. This meticulously crafted saucer seamlessly blends into any environment while offering essential protection for your plants and surfaces.



Item #	Desc	UPC	Vendor	CS/UOS	Location
80921784	12 Pack	087404510069	51006C	20/20	National

BRAUN

GARDEN PRODUCTS

Turquoise Oblong Planters

12" x 5.5" x 3.5"
14" x 6.5" x 4"
15.5" 7" x 4.5"

4 sets of 3 per case, each planter includes a plastic liner.



Item #	Desc	UPC	Vendor	CS/UOS	Location
801370861	Set of 3	619216230356	23035	4/4	East

Pottery Studio Dish Planters

Dimensions: 6" x 2"



Item #	Desc	UPC	Vendor	CS/UOS	Location
81370041	6"	619216004131	00413	24/24	East

Signature Cache Pots

Dimensions:
5" x 4", 6 1/2" x 5"



Item #	Desc	UPC	Vendor	CS/UOS	Location
81370054	Set of 2	619216004513	00451	6/6	East

Antique Mushroom

Galvanized Metal with floral fern prints bring a new edge of design to the mix. Small 6.75" x 6.5" | Medium 9.75" x 6.5" Large 13" x 7.5"
3 sets of 3 per case



Item #	Desc	UPC	Vendor	CS/UOS	Location
81370940	Set of 3	619216023811	2381	3/3	East

Cold Creek

Think of these rustic chic pieces as country with an edge. These galvanized metal planters are NEW!
Small 10" x 5.5" | Medium 12" x 6.5" | Large 15" x 7.5" 5 Sets of 3 per case



Item #	Desc	UPC	Vendor	CS/UOS	Location
81370942	Set of 3	619216023899	2389	5/5	East

BRAUN
GARDEN PRODUCTS



Seagrass Cone Hanging Basket (A)

Waves of tones and textures artlessly fall over these woven seagrass creations. Built on galvanized frames for enhanced durability. Hanging Basket includes stiff, swivel-chain hangers

Item #	Desc	UPC	Vendor	CS/UOS	Location
81370510	14"	619216262012	26201	20/20	East

Cone Leaf Hanging Basket Planter (B)

14" Nature inspired hanging basket made of natural leaves and rattan. Plastic insert and stiff, swivel-hanger included.

Item #	Desc	UPC	Vendor	CS/UOS	Location
81370553	14"	619216365126	36512	20/20	East

Evergreen Cone Hanging Basket (C)

Item #	Desc	UPC	Vendor	CS/UOS	Location
81370508	12"	619216261183	26118	20/20	East

Hanging Basket w/ Mossmat Liner

Growers Essential - anything but ordinary! Mossmat Hanging Basket with galvanized chain.



Item #	Desc	UPC	Vendor	CS/UOS	Location
801370936	12"	619216211133	21113	10/10	East

Oval Farm Containers

12.5" x 8" x 8.5"
14" x 9" x 9.5"
4 sets of 2 per case



Item #	Desc	UPC	Vendor	CS/UOS	Location
801371069	Set of 2	619216080784	8078	4/4	East

Hanging Basket w/ Moisture Liner

Galvanized Chain



Item #	Desc	UPC	Vendor	CS/UOS	Location
801370975	20"	619216611155	61115	10/10	East

Flat Bottom Planter w/ Stiff Swivel Chain Hanger



Item #	Desc	UPC	Vendor	CS/UOS	Location
81370875	Stiff Swivel Chain	61921664047	26404	20/20	East

Two Tone Rattan Flat Bottom Hanger



Item #	Desc	UPC	Vendor	CS/UOS	Location
81371002	14"		00959	20/20	East

Honeycomb Hanger

9" x 9 3/4" - 7 1/2" x 7 1/2"



Item #	Desc	UPC	Vendor	CS/UOS	Location
801371122	set of 2	619216041952	4195	1/1	East

BRAUN

GARDEN PRODUCTS

Boho Pot

Harking back to hand-thrown masterpieces, this artful array ups the interest with a mixed-media approach incorporating stone.



Item #	Desc	UPC	Vendor	CS/UOS	Location
81370956	Small 3 1/2" x 4"	619216004605	460	18/18	East
81370957	Medium 5 1/2" x 5"	619216004612	461	24/24	East

King Cup Cactus

Harking back to hand-thrown masterpieces, this artful array ups the interest with a mixed-media approach incorporating stone.



Item #	Desc	UPC	Vendor	CS/UOS	Location
81370958	5 1/4" x 4 3/4"	619216004599	459	18/18	East

Square Drawer Planter

Part of the Homestead Collection; traditional styling and rustic barn wood make these containers the classic accents every home and garden needs. Plastic lined. 8" x 8" x 4"



Item #	Desc	UPC	Vendor	CS/UOS	Location
81370747	Square	619216028175	02817	16/16	East

Triple Drawer Planter

Plastic lined 13" x 4 1/2" x 4"



Item #	Desc	UPC	Vendor	CS/UOS	Location
81370745	3 Drawers	619216028151	02815	16/16	East



Galvanized Trough Planters

LG- 23" x 6" x 6"

Item #	Desc	UPC	Vendor	CS/UOS	Location
801370889	Large	619216020612	02061	12/12	East



Tapestry Planter

Ceramic planters glazed with bright and bold patterns. All planters come with drainage holes. Round planters 4" x 3 3/4"
Cube planters 3" x 3"

Item #	Desc	UPC	Vendor	CS/UOS	Location
81370834	A Blazing Fire Cylinder	619216082054	8205	24/24	East
81370835	B Blue Sun Cylinder	629216082030	8203	24/24	East
81370838	C Blue Sun Cube	619216082061	8206	24/24	East
81370837	D Blazing Fire Cube	619216082078	8207	24/24	East
801371132	E Matte Mist Cylinder	619216082160	8216	24/24	East
801371126	F Blue Wing Cube	619216082115	8211	24/24	East
801371128	G Sea Green Forest Cylinder	619216082139	8213	24/24	East
801371130	H Longwood Cylinder	619216082146	8214	24/24	East
801371127	I Blue Sky Cube	619216082122	8212	24/24	East

Rectangle Box

Part of the Homestead Collection; traditional styling and rustic barn wood make these containers the classic accents every home and garden needs. Plastic lined.



Item #	Desc	UPC	Vendor	CS/UOS	Location
81370138	8 1/2"x5"x4"	619216028038	02803	16/16	East
81370139	7"x5"x4 1/2"	619216028045	02804	16/16	East

Square Box

Part of the Homestead Collection; traditional styling and rustic barn wood make these containers the classic accents every home and garden needs. Plastic lined.



Item #	Desc	UPC	Vendor	CS/UOS	Location
81370136	4 1/2"x4 1/2"x4"	619216028014	02801	16/16	East
81370137	6"x6"x6"	619216028021	02802	16/16	East

BRAUN

GARDEN PRODUCTS

Water Bucket

Part of the Homestead Collection; traditional styling and rustic barn wood make these containers the classic accents every home and garden needs. Plastic lined.



Item #	Desc	UPC	Vendor	CS/UOS	Location
81370140	8" x 7 1/2"	619216028052	02805	16/16	East

Honeycomb Tall Planters

Made of clays and other naturally-found materials. Frost proof and UV resistant.

9"x9"x18"
12"x12"x24 1/2"
16 1/2" x 16 1/2" x 30 1/2"
3 pieces per set



Item #	Desc	UPC	Vendor	CS/UOS	Location
801370862	3 pc.	619216041136	4113	1/1	East

2025



Medium Garden Bowl (A)

Part of the Boutique Collection, this bowl is old world charm meets new world elegance in a tres chic selection of subtly designed galvanized containers. Includes plastic liner.

Item #	Desc	UPC	Vendor	CS/UOS	Location
81370128	9"x4"	619216024627	02462	16/16	East

Oblong Garden Trough Set (B)

8 1/2" x 5" x 4 1/2", 10" x 5 1/2" x 5", 11" x 6" x 5".
6 sets of 3 per case, Includes plastic liner

Item #	Desc	UPC	Vendor	CS/UOS	Location
81370126	3 pc.	619216024603	02460	6/6	East

Medium Garden Pail (C)

6 1/2" x 5" includes plastic liner

Item #	Desc	UPC	Vendor	CS/UOS	Location
81370131	6 1/2"x5"	619216024658	02465	16/16	East

Lavender Garden Pails (D)

Includes plastic liner. Dimensions: 5" x 5".

Item #	Desc	UPC	Vendor	CS/UOS	Location
81370130	Set of 3	619216024641	02464	16/16	East

Square Wooden Box

Dimensions:
Large: 8"x4"
Medium 7"x4" and
includes plastic liner



Item #	Desc	UPC	Vendor	CS/UOS	Location
801371080	Large	619216026720	02672	16/16	East
801371079	Medium	619216026713	02671	16/16	East



Long Wooded Trough

Part of the Homestead Collection; traditional styling and rustic barn wood make these containers the classic accents every home and garden needs. Plastic lined. They measure 19" x 10" x 3 1/2", 16 1/2" x 8 1/2" x 3", 13 1/2" x 7 1/4" x 2 1/2". 4 sets of 3 per case

Item #	Desc	UPC	Vendor	CS/UOS	Location
81370145	3 pc.	619216028106	02810	4/4	East

Northshore Dish Planter

Lightweight, plastic-lined galvanized metal is long-lasting, while its weathered texture provides authenticity Dimensions: Small 6"x6"x2.5" Medium 8.5" x 3" | Large 11" x 3.5" and includes plastic liner



Item #	Desc	UPC	Vendor	CS/UOS	Location
81370158	Small	619216030246	03024	16/16	East
81370159	Medium	619216030253	03025	16/16	East
81370160	Large	619216030260	03026	16/16	East

Romeo Planters

Romeo 17.5" x 10" x 7" holds 5" pot
no drainage



Item #	Desc	UPC	Vendor	CS/UOS	Location
81370229	Romeo	619216070648	7064	2/2	East

Cleopatra Planter

As part of the Eclectic Garden Boutique Collection these high fashion home and garden planters seemliness meld in this collection of garden accessories, made for cross selling. Holds a 4" pot, no drainage.



Item #	Desc	UPC	Vendor	CS/UOS	Location
81370216	Cleopatra 10"x9"	619216070518	07051	6/6	East

Eclectic Garden Boutique Busts

Easter Island Head 5 1/4" x 4 3/4" x 8" with drainage hole
Greek Goddess 4 1/2"x 5 1/2"x 6 1/2" with drainage hole



Item #	Desc	UPC	Vendor	CS/UOS	Location
81370817	Easter Island Head	619216070693	07069	12/12	East
81370816	Greek Goddess	619216070709	07070	12/12	East



Eclectic Garden Collection Head Planters

Leon 7.5" x 4.5" - Stacy 6.5" x 5.5" - Ned 9" x 5"

Item #	Desc	UPC	Vendor	CS/UOS	Location
801371119	Leon	619216070716	7071	6/6	East
801371121	Stacy	619216070730	7073	6/6	East
801371120	Ned	619216070723	7072	6/6	East

Flat bottom Hanging Basket

14" Nature inspired twisted seagrass hanging basket. Complete with a stiff, swivel chain hanger.



Item #	Desc	UPC	Vendor	CS/UOS	Location
801370906	14"	619216263026	26302	20/20	East

Evergreen Moss Hanging Basket

Sphagnum moss is applied to the outside of a galvanized wire frame for strength and durability to these hanging baskets. Chain included.



Item #	Desc	UPC	Vendor	CS/UOS	Location
81370264	12"	619216211188	21118	20/20	East

Wicker Tear Drop Planter

Dimensions: 9" x 4" x 12"



Item #	Desc	UPC	Vendor	CS/UOS	Location
801370848	12"	619216024221	2422	12/12	East

Wicker Flower Basket

Wicker Flower Basket is ready to plant and features a plastic liner insert. 12" x 7" x 12"



Item #	Desc	UPC	Vendor	CS/UOS	Location
801370837	12"	619216024122	2412	12/12	East

CURTIS WAGNER

PLASTICS

Designer Centerpiece Heavy Plant Tray



Show off your plants without scratches or water damage to your tables. Great for window sill plants as well!

Item #	Desc	UPC	Vendor	CS/UOS	Location
81080089	12" Clear	759188128029	DWT-1200RRP30	30/30	National
81080090	14" Clear	759188014001	DWT-1400RRP30	30/30	National

Plastic and Wire Coco Hanging Basket Drip Pans

Designed to clip underneath either an 8", 10" or 12" dia. plastic hanging basket also available in a 12"/14" size that fits under a wire coco basket to catch water overflow protecting floors & decks. It will also work as a watering device by filling it full of water and letting it self water the hanging basket thru absorption. This is very effective in hot dry weather. Indoor and outdoor use.



Item #	Desc	UPC	Vendor	CS/UOS	Location
81080002	8"	759188000882	HB-8050	50/50	National
81080001	10"	759188510008	HB-1150-50	50/50	National
81080268	12"	759188520007	HB-1200S-50	50/50	National
81080271	12"/14"	759188121440	HB-1214S-50	50/50	National

Clear Vinyl Plant Saucers

The Clear Vinyl Plant Saucers are perfect for indoor and outdoor use to protect all types of floors and decks from water damage by the specially designed airflow bottom which allows air to flow beneath the saucer to prevent moisture build up. The plant saucer catches water overflow allowing the water to be absorbed back into the plant.



Item #	Desc	UPC	Vendor	CS/UOS	Location
81080025	4"	759188040000	CW-400N	1000/50	National
81080026	5"	759188050009	CW-500N	1000/50	National
81080027	6"	759188060008	CW-600N	1000/50	National
81080028	7"	759188070007	CW-700N	1000/50	National
81080029	8"	759188080006	CW-800N	600/50	National
81080030	9"	759188090005	CW-900N	400/50	National
81080031	10"	759188100001	CW-1000N	300/50	National
81080032	11"	759188110000	CW-1100N	200/50	National
81080033	12"	759188120009	CW-1200N	200/25	National
81080034	13"	759188130008	CW-1300N	100/25	National
81080035	14"	759188140007	CW-1400N	100/25	National
81080036	16"	759188160005	CW-1600N	100/10	National
81080037	17"	759188170004	CW-1700N	100/10	National
81080038	21"	759188210007	CW-2100N	25/5	National
81080039	25"	759188250003	CW-2500N	25/5	National



Clear Deep Vinyl Basket Liners

Designed to fit nearly any standard basket. Heavy gauge vinyl liners offer added flexibility and transparency to provide real support for candy and fruit baskets; our heavy-gauge plastic basket liners are best suited for floral arrangements and potted plants. By keeping potting soil and water safely inside the basket, our lineup of plant liners ensure optimal protection for table surfaces and flooring.

Item #	Desc	UPC	Vendor	CS/UOS	Location
81080098	4"	759188000417	L-0041	400/25	National
81080100	5"	759188000516	L-0051	400/25	National
81080099	5" shallow	759188000554	L-0055	25/25	National
81080102	6"	759188000615	L-0061	300/25	National
81080108	8"	759188000813	L-0081	200/25	National
81080110	9"	759188000912	L-0091	25/25	National
81080113	10"	759188010003	DL-10001	300/25	National
81080111	10"	759188001506	L-0015	25/25	National
81080114	11"	759188011000	DL-11001	100/25	National
81080115	12"	759188012007	DL-12001	100/25	National
81080117	14"	759188001407	DL-14001	100/25	National
81080119	16"	759188016005	DL-16001	100/10	National
81080120	17"	759188017002	DL-17001	100/10	National
81080122	Oval	759188755522	OV-750	25/25	National
81080123	Oval	759188934675	OV-970	25/25	National



Clear Designer Heavy Plant Saucer

Extra strong heavy gauge clear plastic footed saucers. Protects carpets and floors. These thick plant trays for indoors and outdoors are engineered with design features that are unique and durable to stand up to frequent and regular use. These will surely protect your terracota plant pots, clay, glassware and plastic plant pots for a long time.

Item #	Desc	UPC	Vendor	CS/UOS	Location
81080056	6"	759188000066	DS-600	25/25	National
81080057	8"	759188000080	DS-800	25/25	National
81080074	8" sq.	759188088514	SQDS-800	25/25	National
81080058	10"	759188000103	DS-1000	25/25	National
81080075	10" sq.	759188111014	SQDS-1000	25/25	National
81080059	12"	759188000127	DS-1200	25/25	National
81080076	12" sq.	759188125011	SQDS-1200	25/25	National
81080060	14"	759188000141	DS-1400	25/25	National
81080077	14" sq.	759188145309	SQDS-1400	25/25	National
81080061	16"	759188000165	DS-1600	25/25	National
81080078	16" sq.	759188165307	SQDS-1600	25/25	National

CURTIS WAGNER

PLASTICS

Vinyl Heavy Plant Saucer

Protects surfaces from water leaks and stains and is made from heavy gauge plastic. Interior ridges help to keep your plant from sitting in a pool of water. Keeps your plant roots healthy.



Item #	Desc	UPC	Vendor	CS/UOS	Location
81080040	4" Terracotta	759188804008	WT-804	25/25	National
81080042	6" Terracotta	759188806002	WT-806	25/25	National
81080044	8" Terracotta	759188808006	WT-808	25/25	National
81080051	10" Black	759188810115	BLK-810	25/25	National
81080052	12" Black	759188812119	BLK-812	25/25	National
81080053	14" Black	759188814113	BLK-814	10/25	National
81080223	16" Black	759188816223	BLK-816	25/25	National
81080054	21" Black	759188211004	BLK-2100	5/5	National
81080055	25" Black	759188251000	BLK-2500	5/5	National



Cork & Fabric Surface Protector Mat

Decorative mat protects furniture and floors, eliminates scratches, and prevents moisture build up by allowing air flow under the molded plastic base plant mat.

Item #	Desc	UPC	Vendor	CS/UOS	Location
81080012	6" Cork Mat	759188681180	MC-600	25/25	National
81080019	6"	759188600013	MA-600	25/25	National
81080013	8" Cork Mat	759188888183	MC-800	25/25	National
81080020	8"	759188800017	MA-800	25/25	National
81080014	10" Cork Mat	759188011185	MC-1000	15/15	National
81080021	10"	759188000011	MA-1000	15/15	National
81080015	12" Cork Mat	759188121181	MC-1200	15/15	National
81080022	12"	759188100025	MA-1200	15/15	National
81080016	14" Cork Mat	759188141189	MC-1400	15/15	National
81080017	16" Cork Mat	759188166182	MC-1600	15/15	National
81080289	4" Dark Cork Mat	759188043278	MCDK-400	25/25	National
81080290	6" Dark Cork Mat	759188683276	MCDK-600	25/25	National
81080291	8" Dark Cork Mat	759188883270	MCDK-800	25/25	National
81080005	6" Asst	759188680008	MC-600A	25/25	National
81080006	8" Asst	759188888008	MC-800A	25/25	National
81080007	10" Asst	759188010102	MC-1000A	15/15	National
81080008	12" Asst	759188120207	MC-1200A	15/15	National
81080009	14" Asst	759188144289	MC-1400A	15/15	National
81080010	16" Asst	759188166281	MC-1600A	15/15	National



Bear Planter

Heavy cement planter with removable drainage plug. TOD 7.08" | Height 5.82"



Item #	Desc	Vendor	CS/UOS	Location
81792431	Bear Planter	260082P-028	8/8	National

Cow Planter

Heavy cement planter with removable drainage plug, perfect for succulents or houseplants.



NATURAL BROWN



LIGHT EARTH

Item #	Desc	Vendor	CS/UOS	Location
81792433	Small - Natural Brown	260074P-700	12/12	National
81792434	Small - Light Earth	260074P-147	12/12	National
81792435	Large - Natural Brown	260073P-700	6/6	National
81792436	Large - Light Earth	260073P-147	6/6	National

Yellow Duck Planter w/ Drainage Plug

TOD 6.49" | Height 5.91"



Item #	Desc	Vendor	CS/UOS	Location
81792432	Yellow Duck	260083P-005	8/8	National

Moose Planter w/ Drainage Plug

TOD 6.89" | Height 5.51"



Item #	Desc	Vendor	CS/UOS	Location
81792430	Moose - Light Brown	260081P-455	8/8	National

Cam the Sloth Planter

No drainage, great for drop ins!



Item #	Desc	Vendor	CS/UOS	Location
81792364	Sloth Planter	260031	6/6	National

CEMENT BUDDIES

Forest animal planters | Adorable addition to any home or garden.



2025

Item #	Desc	Vendor	UOS/CS	Location	Item #	Desc	Vendor	UOS/CS	Location	Item #	Desc	Vendor	UOS/CS	Location				
Bird - S: 6.25" x 4" x 4.75" / L: 8.75" x 5.25" x 5.5"					Owl: 4.5" x 4.25" x 4.75" / L: 5.5" x 5" x 6"					Sleeping Cat - S: 7" x 4.75" x 4" / L: 8" x 5.75" x 4.5"								
81791016	Rust - S	9/3411R/1	12/12	National	81791573	Rust - S	260006P-433	12/12	National	81791575	Rust - S	260010P-433	12/12	National				
81791017	Nat - S	9/3411/1	12/12	National	81791565	Nat - S	260006P-396	12/12	National	81791567	Nat - S	260010P-396	12/12	National				
81791018	Rust - L	9/3412R/1	6/6	National	81791572	Rust - L	260005P-433	8/8	National	81791574	Rust - L	260009P-433	6/6	National				
81790079	Nat - L	9/3412/1	6/6	National	81791564	Nat - L	260005P-396	8/8	National	81791566	Nat - L	260009P-396	6/6	National				
Elephant - 7" x 5" x 6"					Piglet - S: 6" x 3.75" x 3.5" / L: 7.5" x 4.75" x 4"					Sleeping Dog: 7" x 6.25" x 3.25"								
81791571	Rust	260004P-433	8/8	National	81791578	Rust - S	260014P-433	12/12	National	81791576	Rust - S	260011P-433	6/6	National				
81791563	Natural	260004P-396	8/8	National	81791570	Nat - S	260014P-396	12/12	National	81791568	Nat - S	260011P-396	6/6	National				
Frog - S: 5.75" x 4.75" x 4" / L: 7.5" x 6" x 5.5"					Rabbit - S: 6" x 4.75" x 3.75" / L: 8" x 6" x 4.5"					Snail - S: 5.75" x 4.5" x 4.25" / L: 8" x 6" x 5.5"								
81791027	Rust - S	9/3431R/1	18/18	National	81791019	Rust - S	9/3441R/1	12/12	National	81791031	Rust - S	9/3471R/1	12/12	National				
81791028	Nat - S	9/3431/1	18/18	National	81790089	Nat - S	9/3441/1	12/12	National	81791032	Nat - S	9/3471/1	12/12	National				
81791029	Rust - L	9/3432R/1	8/8	National	81791020	Rust - L	9/3442R/1	6/6	National	81791033	Rust - L	9/3472R/1	4/4	National				
81791030	Nat - L	9/3432/1	8/8	National	81790088	Nat - L	9/3442/1	6/6	National	81790076	Nat - L	9/3472/1	4/4	National				
Hedgehog - S: 5" x 4.25" x 3" / L: 7.75" x 6" x 4.25"					Turtle - S: 6" x 4.75" x 3.5" / L: 7.75" x 6" x 4.5"													
81791021	Rust - S	9/3431R/1	18/18	National						81791024					Rust - S	9/3451R/1	12/12	National
81791022	Nat - S	9/3431/1	18/18	National						81791025					Nat - S	9/3451/1	12/12	National
81791023	Rust - L	9/3432R/1	8/8	National						81791026					Rust - L	9/3452R/1	6/6	National
81790078	Nat - L	9/3432/1	8/8	National						81790077					Nat - L	9/3452/1	6/6	National

All animals have removable drainage plugs!



Classic Coral Fish

Overall 6.5" long with removable drainage plug.

Item #	Desc	Vendor	CS/UOS	Location
81792196	3.5"	260032-579	16/16	National

Large Mouth Fish Planter

Cement planters opening diameter 3 1/2" - overall height 4 1/4" - Volume 0.34 gal Removable drainage plug



Item #	Desc	Vendor	CS/UOS	Location
81792119	Weathered Bronze	260023-C154	16/16	National
81792118	Light Earth	260023-C147	16/16	National

Rooster Planter

Cement rooster planter with removable drainage plug. Open diameter 5" Overall height 7" Volume 0.3 gal



Item #	Desc	Vendor	CS/UOS	Location
81792123	Rooster planter	260027-C148	8/8	National

Cement Shell Planter

Sea Shell planters made of cement feature a removable drainage plug. Opening diameter 5" - Overall height 2.5" Volume 0.15 gal



Item #	Desc	Vendor	CS/UOS	Location
81792222	Harbor Blue	260025-580	24/24	National

Maxwell Planters

Maxwell cement planters with removable drainage plug. Perfect for succulents, foliage or flowers! 4" x 4"



Item #	Desc	Vendor	CS/UOS	Location
81792191	Round Country Blue Weave	210055-580	12/12	West

Zinc and Black Cement Pot Assortments

Small:5.3x5.3x4.7
Large:7.5x7.5x6.1
*Comes with a removable drainage plug



Item #	Desc	Vendor	CS/UOS	Location
81791819	Small MOD Zinc & Black Assorted	31006	12/12	National
81791820	Large MOD Zinc & Black Assorted	31007	8/8	National

Kiawah Ceramic Planters

Ceramic containers are perfect additions to your planter selection. Drop in succulents or houseplants. Features removable drainage holes 4" (Case pack of 24) 6" (Case pack of 12)



Item #	Desc	Vendor	CS/UOS	Location
81792406	4" Sage & Denim	K90080-000	24/1	National
81792410	6" Sage & Denim	K90078-000	12/1	National

Artie Ceramic Planter

These detailed ceramic containers are perfect for houseplants. Features removable drainage plug. Case pack of 8. (4 each Quarry / Grey)



Item #	Desc	Vendor	CS/UOS	Location
81792411	6" Quarry & Gray 8 per case	K90079-000	1/1	National

Colchester Ceramic Planter

Ceramic containers are perfect additions to your planter selection. Drop in succulents or houseplants. Features removable drainage holes 4" - Case pack 8" -Case pack 24



Item #	Desc	Vendor	CS/UOS	Location
81792407	4" - Grey 24 per case	K90103-781	1/1	National
81792418	8" - Grey 6 per case	K90104-781	1/1	National

Wood Grain Ceramic Planter

White ceramic band complements wood grain, has removable drainage plug.



Item #	Desc	Vendor	CS/UOS	Location
81792355	White with Wood Grain 5.25"x5"	50022	12/12	West



Yellow Sun Cement Pot

Cement planter with removable drainage plug. Open diameter 4 1/3" Overall height 4" Volume 0.55 gal



Item #	Desc	Vendor	CS/UOS	Location
81792198	4.3" x 4"	210054P-396	16/16	National



Geometric Ceramix Planters

Colorful ceramic containers are perfect additions to your planter selection. Drop in succulents or houseplants. Features removable drainage holes

Item #	Desc	Vendor	CS/UOS	Location
81792401	4" Asst Pink Green Blue Purple 24 per case	K90073-000	1/1	National
81792402	4" Mix White & Black 24 per case	K90074-000	1/1	National
81792346	5.7" x 4.2" Black	50000-EB	16/16	National
81792412	6.5" White 6 per case	K90105-089	1/1	National
81792413	6.5" Dark Blue 6 per case	K90105-448	1/1	National
81792417	8" Dark Blue 4 per case	K90107-448	1/1	National
81792416	8" White 4 per case	K90107-089	1/1	National
81792347	8.27" x 5.35" White	50001-WH	6/6	National
81792348	8.27" x 5.35" Black	50001-EB	6/6	National

2025

Cement Heart Pots

Made of cement and featuring a removable drainage plug these containers are perfect for succulents or foliage plants.



Item #	Desc	Vendor	CS/UOS	Location
81791694	Red Heart 4.7X4.7x6.5	210027P-396	12/12	National
81791695	Red Heart 5.5X5.5x5.1	210028P-396	12/12	National
81791696	Red Heart 4.3X4.3x4	210029P-396	18/18	National
81791697	Red Heart Low Bowl 6.5X6.5x3.1	280000P-396	12/12	National
81791709	Red Wash White Heart 5.2X5.2x4.9	210019-131	12/12	National
81791710	Red Wash White Heart	210019P-328	12/12	National



Dotted Ceramix Planters

Colorful ceramic containers are perfect additions to your planter selection. Drop in succulents or houseplants. Features removable drainage holes.

Item #	Desc	Vendor	CS/UOS	Location
81792400	2.5" Mix Blue, Green, White & Pink 96 per case	K90072-000	1/1	National
81792405	4" - Black 24 per case	K90108-001	1/1	National
81792404	4" - White 24 per case	K90108-089	1/1	National
81792403	4" Mix Pink, Green, Blue & Purple 24 per case	K90075-000	1/1	National
81792350	5.7" x 4.2" Black	50002-EB	16/16	National
81792414	6.5" - White 6 per case	K90106-089	1/1	National
81792415	6.5" - Dark Blue 6 per case	K90106-448	1/1	National
81792352	8.27" x 5.35" Black	50003-EB	6/6	National

Bella Planter

At a height of 9.5" and a top outside diameter of 9.9", the Bella planters are fantastic for all your plantings requiring a deeper rooting solution. Made of plastic resin.



Item #	Desc	Vendor	CS/UOS	Location
81791040	7" Metallic Red	1258-098M	25/25	National
81791897	10" Metallic Frosted Pearl	1255-027M	1/20	National
81791042	10" Metallic Red	1255-098M	20/20	National



Lavastone Luzon Urn

14.25" W x 13.25" H
has drainage plug.



Item #	Desc	Vendor	CS/UOS	Location
81792184	14.25 X 13.25	LS7415	1/1	National

Chelsea Round Planter

Dura Fiber Antique Zinc
13.4" x 12.6"
16.5" x 16.1"
20.1" x 19.3"



Item #	Desc	Vendor	CS/UOS	Location
81792464	Chelsea Planter	10026-AZ	1/1	National

Ancient Cement Handled Planter

Comes with removable drainage plug



Item #	Desc	Vendor	CS/UOS	Location
81792152	6.5X5X4.3	45002	12/12	West

Dakota Trough

Cement planter with removable drainage plug.
8" x 3" x 3"



Item #	Desc	Vendor	CS/UOS	Location
81791532	Earth Moss	240001P-432	16/16	National
81791531	Rust	240001P-433	16/16	National

Jake Planter

14" Resin planter straw finish with drainage. Feels and looks real! Overall height 10" - Holds 4 gallon volume



Item #	Desc	Vendor	CS/UOS	Location
81792085	14" Jake planter	2014D-587R	12/12	National

Flora Trio

Cement planters with assorted white and green interiors. Perfect for any houseplant. Comes with a removable drainage plug.



Item #	Desc	Vendor	CS/UOS	Location
81791813	5.3x5.3x4.7	31000	12/12	National
81791814	7.5x7.5x6.1	31001	6/6	National

Tin Planter w/ Faux Hose



Item #	Desc	Vendor	CS/UOS	Location
81791418	12"x7"x11"	13069	4/4	National

License Plate Metal Planters

Rectangle Sizes: L: 11.6"x6.3"x5.9" S: 8.7"x4.7"x5.5"
Round Sizes: L: 8.9"x8.9"x6.9" S: 8.1"x8.1"x6.7"
Square Sizes: L: 6"x6"x6" S: 5"x5"x5.5"



Item #	Desc	Vendor	CS/UOS	Location
81791372	Rectangle	13013	2/2	National
81791373	Round	13014	2/2	National
81791398	Square	13048	2/2	National

Tin Planters

7.1" x 7.1" x 5.9" & 5.1" x 5.1" x 4.92"



Item #	Desc	Vendor	CS/UOS	Location
81791404	Set of 2	13055	2/2	National



Self-Watering Raised Garden Bed

Item #	Desc	Vendor	CS/UOS	Location
81792439	30"	740000P-101	4/4	National



Falmouth Planter

Item #	Desc	Vendor	CS/UOS	Location
81792427	11" square white	1071CP18B-340V	18/18	National
81792556	16" square white	HD1453CP20B-340V	20/20	National
81792428	24" Deck Rail Window Box	1074CP10B-340V	10/10	National
81792429	24" Window Box	1075CP16B-340V	16/16	National



Arc Bowl Planter

With Drainage plug
12.5"x8.5"x5.25"

Item #	Desc	Vendor	CS/UOS	Location
81791748	Stone	573D-120	20/20	National
81791749	Desert	573D-514	20/20	National
81792084	Concrete	573D-102	20/20	National
81792083	Georgia Clay	573D-093	20/20	National

Birch Oval Planter

Beautiful Birch oval resin planter, with no drainage. Choose from two sizes.
12" L x 6" W x 6.5" H (1.22gal)
16" L x 6.1" W x 6.5" H (1.8gal)



Item #	Desc	Vendor	CS/UOS	Location
81792374	12"	512D-516	24/24	National
81792382	16"	516D-516	20/20	National



North Star Pot

Mixed case pack of ceramic white, gold, red, and silver with north star raised prints. Features removable drainage plugs. Case pack of 24 - 6 of each color

Item #	Desc	Vendor	CS/UOS	Location
81792408	4" Case of 24 White, Gold, Red, Silver	K90076-000	1/1	National

Doherty 12" Pots

12" resin planters with drainage. Opening diameter 11.62" Overall height 9.12" Volume 2.75gal - Great for drop ins or to grow in!



Item #	Desc	Vendor	CS/UOS	Location
81792106	Grained Sky Blue	112D-555R	16/16	National

Penguin & Frosty Mix Planter

Heavy cement planters come in a mixed case pack with Penguin and Snowman. Fits a 4" pot and has a removable drainage plug. Case pack of 18 - 9 each Penguin/Snowman



Item #	Desc	Vendor	CS/UOS	Location
81792409	4" Penguin & Frosty Mix	K90077-396	1/1	National



Elle Planter w/ Plug

Resin planter with drainage plug, upgrade any houseplant!

Item #	Desc	Vendor	CS/UOS	Location
81792368	4.7" Gray	404CP24D-352	24/24	National
81792370	4.7" Sand	404CP24D-586	24/24	National
81792366	4.7" Cast	404CP24D-060	24/24	National



Tilden Self Watering Pots

6" self watering features a total of five pots (2 white 2 gray 1 teal). Pricing per set

Item #	Desc	Vendor	CS/UOS	Location
81792344	6" - 5 colors	10106CP5D-000V	1/1	National
81792342	8",10", & 12" - White	10111D-622V	1/1	National

Capello Planter

6" Capello resin hanging basket with saucer and hanger. Perfect for dropping in succulents or houseplants. Hanging basket opening diameter 6.69" x 4.53" high. Comes with 18" braided hanger and snap on saucer. Holds .48gal soil volume. Choose from Sandstone, Star White, Black or Antique Copper



Item #	Desc	Vendor	CS/UOS	Location
81792240	6" Star White	2001MS6D-340PHNG	50/50	National
81792262	6"-Antique Copper w/ black hanger	2001MS6D-174PHNG	50/50	National

Vogue Planter

A lightweight planter with striking finishes makes the Vogue a true gardener's solution. Indoor or outdoor use - weather resistant - UV coated finish protects color from fading. Delivered without drainage holes, if needed, holes are easily drilled in bottom of planter. Lightweight yet durable construction.



Item #	Desc	Vendor	CS/UOS	Location
81791510	8" Willow Green	807-187R	12/12	National
81792305	8" Stark White	807-405S	12/12	National



Corinthian Collection

Bowl: Drainage hole
Trough: Removable drainage plug
Round: Drainage holes

Item #	Desc	Vendor	CS/UOS	Location
BOWL				
81791047	12" Bowl Cast Iron	9478D-059	12/12	National
81791046	12" Bowl Cast Concrete	9478D-060	12/12	National
81791165	12" Bowl Oil Rubbed Copper	2/9478/1-097	12/12	National
ROUND				
81792017	8" Round Cast Concrete	9408CP28D-060	28/28	National
81792071	8" Round Oil Rubbed Copper	9408CP28D-238	28/28	National
81792019	8" Round Storm	9408CP28D-515	28/28	National
81792199	8" Round Slate Blue	9408CP28D-597	28/28	West
81792018	8" Round Desert	9408CP28D-514	28/28	West
81791727	10" Round Storm	9411D-515	28/28	National
81791724	10" Round Cast Concrete	9411CP28D-060	28/28	National
81792072	10" Round Oil Rubbed Copper	9411CP28D-238	28/28	National
81792210	10" Round Slate Blue	9411CP28D-597	28/28	West
81791725	10" Round Desert	9411CP28D-514	28/28	West
81791731	13" Round Storm	9413-515 CP	20/20	National
81791728	13" Round Cast Concrete	9413CP20D-060	20/20	National
81792073	13" Round Oil Rubbed Copper	9413CP20D-238	20/20	National
81791729	13" Round Desert	9413CP20D-514	20/20	West
TROUGH				
81791735	10" Trough Storm	9410-515 CP	36/36	National
81791732	10" Trough Cast Concrete	9410-060 CP	36/36	National
81792212	10" Trough Slate Blue	9410CP36D-597	36/36	West
81791733	10" Trough Desert	9410CP36D-514	36/36	West
81792076	18" Trough Storm	9418CP36D-515	36/36	National
81792074	18" Trough Cast Concrete	9418CP36D-060	36/36	National
81792077	18" Trough Oil Rubbed Copper	9418CP36D-238	36/36	National
81792075	18" Trough Desert	9418CP36D-514	36/36	West
81792223	18" Trough Slate Blue	9418CP36D-597	36/36	West



Terranova Cylinder

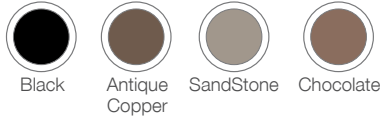

Item #	Desc	Vendor	CS/UOS	Location
81792586	8" Black	TN8CP24D-001P	24/24	National
81792587	8" Sand Stone	TN8CP24D-045P	24/24	National
81792568	10" Black	TN10CP20D-001P	20/20	National
81792570	10" Antique Copper	TN10CP20D-174PB	20/20	National
81792569	10" Sand Stone	TN10CP20D-045P	20/20	National
81792454	10" Black Bowl	TNB10HPD-001P	2300/2300	National
81792575	12" Black	TN12CP24D-001P	24/24	National
81791943	12" Chocolate	TN12D-002P CP	250/250	National
81792450	12" Antique Copper	TN12CP58D-174PB	58/58	East
81792577	12" Antique Copper	TN12CP24D-174PB	24/24	National
81792576	12" Sand Stone	TN12CP24D-045P	24/24	National
81791947	12" Antique Copper	TN12D-174PB CP	250/250	National
81791960	14" Black	TN14D-001P	1680/1680	National
81791954	14" Black	TN14D-001P CP	250/250	National
81791959	14" Antique Copper	TN14D-174PB CP	250/250	National
81791965	14" Antique Copper	TN14D-174PB	1680/1680	National
81791957	14" Sand Stone	TN14D-045P CP	250/250	National
81791963	14" Sand Stone	TN14D-045P	1680/1680	National



Alena Collection Weathered design

9": 8.9"x8.9"x6.25" | 12": 12"x12"x8.5"

Item #	Desc	Vendor	CS/UOS	Location
81791761	9" Enamel	10509D-532 CP	26/26	National
81791760	9" Galvanized	10509D-531 CP	26/26	National
81791861	9" Copper	10509D-377R CP	26/26	National

Greenwich Urn

Resin Urns - bottoms screw on and off for easy storage. Pre-drilled drainage hole with one inch water reservoir. 16"x16"x18" with drainage



Item #	Desc	Vendor	CS/UOS	Location
81792604	Textured Granite	39451D-922R	6/6	National
81792603	Fossil Matte	39451D-459R	6/6	National

Bellina Planter



Item #	Desc	Vendor	CS/UOS	Location
81791075	8" Fossil	50D-039T	50/50	National
81791038	12" Metallic Red	555D-098M	24/24	National



Honeysuckle Planters

Resin planters with drainage. 13" Opening diameter - 10 1/2" height Volume 3.6 gal
15" Opening diameter - 12 1/4" height 5.6 gal

Item #	Desc	Vendor	CS/UOS	Location
81791099	13" Fossil	554D-039T	48/48	National
81791104	13" Blue Jean	554D-252R	48/48	National
81791605	15" Fossil	553D-039T	20/20	East
81791091	15" Fossil	553D-039T	24/24	East
81791093	15" Stone	553D-120T	24/24	National
81791096	15" Blue Jean	553D-252R	24/24	National
81792115	15" Tequila Sunrise	553D-245R	24/24	National
81792117	15" Distressed Copper	553D-245R	24/24	National
81791630	15" Vanilla	553D-290S	24/24	National



Haverhill Planters

Item #	Desc	Vendor	CS/UOS	Location
PLANTER				
81791145	12" Antique Copper	FM1403CP30D-174PB	30/30	National
81792293	12" Hanging Basket w/18" Hanger- Antique Copper	FM1412CP42D-174PB	42/42	National
BOWL				
81791139	12" Soap Stone	FM1402CP30D	30/30	National

Verona Planters

Step up your plantings with these beautiful resin containers. 11" Hanging Basket comes with hanger and water disk, holds 1.8gal 11" Round with drainage holds 2.2gal 10" Square with drainage holds 2.4gal



Item #	Desc	Vendor	CS/UOS	Location
81792384	11" Hanging Basket Antique Copper	1420D-174PB	30/30	East

Nantucket Planter

Classic basket weave planter is made of durable resin construction and has drainage holes. Weather resistant, UV coated finish protects color from fading.



Item #	Desc	Vendor	CS/UOS	Location
81791352	8" Russet	34208D-408R	20/20	National
81791353	8" Harbor Gray	34208D-409R	20/20	National
81791354	10" Russet	34210D-408R	20/20	National
81791355	10" Harbor Gray	34210D-409R	20/20	National
81791356	12" Russet	34212D-408R	12/12	National
81791357	12" Harbor Gray	34212D-409R	12/12	National

Spartan Eco Cast Urn



Item #	Desc	Vendor	CS/UOS	Location
81791048	12" Cast Concrete	568D-060	10/10	National
81791049	12" Cast Iron	568D-059	10/10	National
81791050	12"-Oil Rubbed Bronze	568D-238	10/10	National



Shaina Planter 15"

Great for drop ins! No drainage

Item #	Desc	Vendor	CS/UOS	Location
81791445	Patina Copper	8005D-378R	12/12	National
81791443	Weathered Copper	8005D-377R	12/12	National
81791444	Indigo	8005D-375R	12/12	National
81791447	Earth	8005D-188T	12/12	National



Rosie Bowl with Saucer 10"

10" L x 10" W x 5" H

Item #	Desc	Vendor	CS/UOS	Location
81791439	Weathered Copper	9010D-377R	12/12	National
81791438	Indigo	9010D-375R	12/12	National
81791435	White	9010D-4055	12/12	National



Dorado Planters

Item #	Desc	Vendor	CS/UOS	Location
81792506	12" Shadow Grey	1612CP40D-653P	40/40	National
81792504	12" Antique Copper	1612CP40D-174PB	40/40	National
81792515	14" Shadow Grey	1620CP29D-653P	29/29	National
81792512	14" Antique Copper	1620CP29D-174PB	29/29	National
81792513	14" Antique Copper	1620CP29D-174PB	29/29	National
81792531	17" Shadow Grey	615D-653P	32/32	National

ROUND PLANTER



Cloud Grey

Aqua

Distressed Copper

HANGING PLANTER



Cloud Grey

Aqua

Distressed Copper

TALL PLANTER



Cloud Grey

Aqua

Distressed Copper

2025



Cachepot Hanging Tray

5" x 4.13"

Item #	Desc	Vendor	CS/UOS	Location
81792559	8 Count Mixed Tray	K90097P-396	8/8	National

Flair Planter

Item #	Desc	Vendor	CS/UOS	Location
--------	------	--------	--------	----------

ROUND PLANTER

81792485	13" Cloud Grey	1013CP18D-877R	18/18	National
81792484	13" Aqua	1013CP18D-735R	18/18	National
81792483	13" Distressed Copper	1013CP18D-183R	18/18	National
81792491	18" Cloud Grey	1018CP9D-877R	9/9	National
81792490	18" Aqua	1018CP9D-735R	9/9	National
81792489	18" Distressed Copper	1018CP9D-183R	9/9	National
81792554	22" Cloud Grey	HD11029CP5D-877R	5/5	National
81792553	22" Aqua	HD11029CP5D-735R	5/5	National
81792552	22" Distressed Copper	HD11029CP5D-183R	5/5	National

HANGING PLANTER

81792488	14" Cloud Grey with Hanger	1014CP24D-877R	24/24	National
81792487	14" Aqua with Hanger	1014CP24D-735R	24/24	National
81792486	14" Distressed Copper with Hanger	1014CP24D-183R	24/24	National

TALL PLANTER

81792494	16" Cloud Grey	1031CP7D-877R	7/7	National
81792493	16" Aqua	1031CP7D-735R	7/7	National
81792492	16" Distressed Copper	1031CP7D-183R	7/7	National



Happy Face Tray

6.5" x 5.71"

Item #	Desc	Vendor	CS/UOS	Location
81792560	6 Count Mixed Tray	K90099P-089	6/6	National



Animal Tray

4.13" x 3.74"

Item #	Desc	Vendor	CS/UOS	Location
81792561	12 Count Mixed Tray	K90100P-000	12/12	National

SUTTON PARK COLLECTION

Elegant design | Pre-drilled holes allow for drainage.



POTS & PLANTERS

2025

Item #	Desc	Vendor	CS/UOS	Location
--------	------	--------	--------	----------

WINDOW BOX

81791316	15" Oil Rubbed Copper	6004D-164PB	44/44	National
81791315	15" Slate	6004D-287PB	44/44	National

SQUARE

81791296	7" Oil Rubbed Copper	7010D-164PB	34/34	National
81791295	7" Slate	7010D-287PB	34/34	National
81791300	10" Oil Rubbed Copper	3006D-164PB	28/28	National
81791299	10" Slate	3006D-287PB	28/28	National

BOWL

81791312	11" Oil Rubbed Copper	6002D-164PB	64/64	National
81791311	11" Slate	6002D-287PB	64/64	National

HANGING BASKET - come with a water saving disc and hanger

81791288	11" Oil Rubbed Copper	6003D-164PB	38/38	National
81791287	11" Slate	6003D-287PB	38/38	National
81792361	13" Oil Rubbed Copper	6005CP54D-164PB	54/54	National
81792363	13" Slate	6005CP54D-287PB	54/54	National

ROUND

Item #	Desc	Vendor	CS/UOS	Location
81791292	7" Oil Rubbed Copper	90008D-164PB	34/34	National
81791291	7" Slate	90008D-287PB	34/34	National
81791324	8.5" Oil Rubbed Copper	90004D-164PB	40/40	National
81791323	8.5" Slate	90004D-287PB	40/40	National
81791303	11" Slate	3004D-287PB	38/38	National
81791304	11" Oil Rubbed Copper	3004CP38D-164PB	38/38	National
81791330	12" Chocolate w/cage	90005D-002P	38/38	National
81791332	12" Oil Rubbed Copper w/cage	90005D-164PB	38/38	National
81791331	12" Slate	90005CP38D-287PB	38/38	National
81791536	12" Verde Stone w/cage	90005CP38D-036PB	38/38	National
81791308	13" Oil Rubbed Copper	1403CP30D-164PB	30/30	National
81791307	13" Slate	1403D-287PB	30/30	National

Moroccan Bowl

Resin planter with drainage plug.

7" x 2 3/4"

10" x 4"



Item #	Desc	Vendor	CS/UOS	Location
81792078	7" Cast Concrete	577D-060	50/50	National
81792079	7" Oil Rubbed Bronze	577D-097	50/50	National
81792081	7" Storm	577D-515	50/50	National
81791740	10" Cast Concrete	572D-060 CP	20/20	National
81791741	10" Oil Rubbed Bronze	572D-097 CP	20/20	National
81791743	10" Storm	572D-515 CP	20/20	National



Devoncourt Planters

Resin planters with drainage 11" hanging basket comes with hanger and water disc - holds 1.8 gal volume.

11" round holds 2.2 gal, 10" square holds 2.4 gal

Item #	Desc	Vendor	CS/UOS	Location
81792128	11" HB Antique Copper	1400D-173PB	30/30	National
81792130	10" Sq Antique Pewter	1402D-173PB	20/20	National
81792242	20" Window Box Antique Copper	1405D-174PB	24/24	National
81791060	11" Round Antique Pewter	1404D-173PB	24/24	National



ACACIA WOOD COLLECTION



Item #	Desc	Vendor	CS/UOS	Location
81791711	Trellis Planter 13.8"x13.8"x15.3"x45.7"	160014	1/1	National
81791712	1/2 Barrel Planter 19.7"x13.8"x7.5" 15"x11.8"x6.7"	160015	1/1	National
81791713	Oval Planter 18.1"x10.2"x9.5" 15.4"x8.3"x8.3"	140011	1/1	National
81791009	Barrel Trio Sold As Set Of 3; SM: 11.38"x7"H; MED: 12.88"x8.38"H; L: 15.63"x9.63H	5/800/3	1/1	National
81791714	21" Barrel Planter 20.9"x20.9"x12.6"	110024	4/4	National
81791715	16" Barrel Planter 15.7"x15.7"x9.5"	110025	6/6	National



Jameson Deck Rail Planters

Item #	Desc	Vendor	CS/UOS	Location
81791361	15" Oak Round	1072D-265R	18/18	National
81791362	24" Oak Window Box	1073D-265R	12/12	National



Distressed Barrel Planters

Item #	Desc	Vendor	CS/UOS	Location
81791351	6" Chestnut	34906D-407R	120/120	National
81791888	8" Chestnut	34908D-407R	80/80	National
81790010	9" Oak	S74D-265R	30/30	National
81791902	9" Kentucky Walnut	S74D-037R	30/30	National
81790011	15" Oak	S72D-265R	18/18	National
81791892	15" Kentucky Walnut	S72D-037R	18/18	National
81790012	20.5" Oak	S1027D-265R	10/10	National
81792285	20.5" Kentucky Walnut	S1027D-037R	10/10	National

Square Plant Stands

8.3" x 19.7"
9.8" x 23.6"
11.4 x 27.6"



Item #	Desc	Vendor	CS/UOS	Location
81792526	Set of 3	42005-GY	1/1	National

Dotty Mini Vase Trio

The Dotty Mini Vase Trio from Burgon & Ball® features unique, dimpled patterns and hand-dipped glazes in complementary colors, making them the perfect statement pieces for displaying a few stems of fresh or dried flowers. Plus, they're pre-boxed for easy gifting. Aqua, blue and soft mushroom colors. Measures 4"x2.75." Four sets of 3 per case.



Item #	Desc	UPC	Vendor	CS/UOS	Location
81380733	3 Pack	810256018823	GIG/DOTVASETRIO	4/4	National

Hanging Baby Dotty Trio Pots

Baby Dotty is an adorably tiny hanging indoor pot, just perfect for those small-but-perfectly-formed baby succulents. It has a charming hand-crafted feel, with a slightly wavy edge to the rim. On the lower half of each pot there's a beautiful dip-glaze, which accentuates the interesting dimpled texture. No drainage, pot measures 2.5"x2.75"



Four sets of 3 per case.

Item #	Desc	UPC	Vendor	CS/UOS	Location
81380735	Set of 3	810256018588	GIG/HDOTTRIO	4/4	National

Hanging Baby Bombini Trio Vases

The Hanging Baby Bombini Trio Vases are perfect for displaying small plants to add a natural touch to your home and come finished with waxed cotton hanging cord for your convenience. Plus, they're pre-boxed for easy gifting. No drainage, aqua, blue and soft mushroom colors. Measures 3"x3.5"



Four sets of 3 per case.

Item #	Desc	UPC	Vendor	CS/UOS	Location
81380734	Set of 3	810256018830	GIG/HBOMTRIO	16/16	National



AZURA SERIES

Molded Plastic | *Textured surface offers distinctive natural material look*



Square Patio Planter (A)

Holds approximately 5.20 gallons 15.25" x 15.25" x 12.25".

Item #	Desc	UPC	Vendor	CS/UOS	Location
80930008	15" Cappuccino	069244145144	1415-14	6/6	East
80930009	15" Granite	069244145304	1415-30	6/6	East
80930010	15" Black	069244145366	1415-36	6/6	East

Urn Planter (B)

Embossed pattern, holds 4.53 gallons 15.25"x20.25".

Item #	Desc	UPC	Vendor	CS/UOS	Location
80930012	15" Cappuccino	069244142143	1420-14	6/6	East
80930013	15" Granite	069244142303	1420-30	6/6	East
80930015	15" Black	069244142365	1420-36	6/6	East

Rectangular Patio Planter (C)

Holds 5.76 gallons 27" x 11" x 8¾"

Item #	Desc	UPC	Vendor	CS/UOS	Location
80930019	Cappuccino	069244147148	1427-14	6/6	East
80930020	Granite	069244147308	1427-30	6/6	East
80930021	Black	069244147360	1427-36	6/6	East

Round Patio Planter (D)

This Azura round patio planter holds approximately 4.23 gallons 15.25" x 9.75".

Item #	Desc	UPC	Vendor	CS/UOS	Location
80930004	15" Cappuccino	069244140149	1410-14	6/6	East
80930005	15" Granite	069244140309	1410-30	6/6	East
80930006	15" Black	069244140361	1410-36	6/6	East



Futura Patio Planter

Classic design. Thick walled made of food safe materials. Drainage plug included. Recyclable UV treated to resist fading.



Item #	Desc	UPC	Vendor	CS/UOS	Location
80930428	18" Round Black	069244418361	4018-36	6/6	East

Harmony Rail Planter

Self-watering planter with a unique textured vertical finish. Features overflow protection. Ideal for growing vegetables and herbs. Unique notched base fits on either a 2" x 4" or 2" x 6" rail. 27" x 11³/₄" x 9¹/₂" holds 6.2 gal.



Item #	Desc	UPC	Vendor	CS/UOS	Location
80930306	Slate	069244357042	3527-04	6/6	East
80930104	Black	069244357363	3527-36	6/6	East

Bamboo Self-Watering Planter

Contemporary Design Planters with a unique textured horizontal finish, water reservoir and overflow protection.



Item #	Desc	UPC	Vendor	CS/UOS	Location
80930483	5" Red	069244885514	8805-51	6/6	East
80930484	5" Green	069244885804	8805-80	6/6	East

Harmony Tall Planter

Self-watering planter. Unique textured vertical finish. Overflow protection.



Item #	Desc	UPC	Vendor	CS/UOS	Location
80930094	12" Black	069244352368	3512-36	6/6	East
80930099	16" Black	069244356366	3516-36	4/4	East

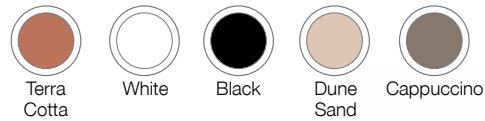

Distinction Window Box (E)

Both flexible and durable. Perfect for indoor and outdoor use. All planters from the Distinction line are UV protected. 24" x 7" x 7" 3.28 gal, 30" x 7" x 7" 4.11 gal.

Item #	Desc	UPC	Vendor	CS/UOS	Location
80930173	24" Black	069244224368	4224-36	6/6	East
80930174	24" Dune Sand	069244224580	4224-58	6/6	East
80930176	24" Terra Cotta	069244224719	4224-71	6/6	East
80930172	24" White	069244224092	4224-09	6/6	East
80930184	30" Dune Sand	069244231588	4230-58	6/6	East
80930185	30" Terra Cotta	069244231717	4230-71	6/6	East
80930183	30" Black	069244231366	4230-36	6/6	East
80930182	30" White	069244231090	4230-09	6/6	East

Futura Window Box (F)

Indoor/outdoor use. Product supplied with a plug for indoor use and perforated cap for outdoor use.

Item #	Desc	UPC	Vendor	CS/UOS	Location
80930071	18" Cappuccino	069244282146	2800/0-14	6/6	East
80930073	18" Terra Cotta	069244282719	2800/0-71	6/6	East
80930079	24" Cappuccino	069244291148	2900/0-14	6/6	East
80930085	24" Terra Cotta w/ brackets	069244296716	2900/6-71	6/6	East

Nova Balcony Planter (G)

Terra Cotta window box, includes plastic brackets and drainage plug. Measures. 30" x 8" x 5" and holds 3.30 gal.

Item #	Desc	UPC	Vendor	CS/UOS	Location
80930059	24" Terra Cotta	069244264715	2024/6-71	6/6	East
80930058	24" White	069244264098	2024/6-09	6/6	East
80930061	30" Terra Cotta	069244260717	2030/6-71	6/6	East

Plastic Bracket

9" X 4.5"



Item #	Desc	UPC	Vendor	CS/UOS	Location
80930233	2pc	069244230369	PB-2000	12/12	East



Self-Watering Planter

Self watering pot. The perfect balance of water, air and soil will insure healthy plants. Soluble fertilizer may be added to the water.



Item #	Desc	UPC	Vendor	CS/UOS	Location
80930563	6" Light Grey w/ Saucer	069244466201	4606-20	6/6	East
80930565	6" Mocha w/ Saucer	069244466546	4606-54	6/6	East
80930568	8" Light Grey w/ Saucer	069244468205	4608-20	6/6	East
80930567	8" Tall Mocha	069244358544	3508-54	6/6	East
80930545	10" Light Grey w/ Saucer	069244460209	4610-20	6/6	East
80930549	12" Light Grey w/ Saucer	069244462203	4612-20	6/6	East
80930548	12" Tall Mocha	069244352542	3512-54	6/6	East



Black Trivet

Item #	Desc	UPC	Vendor	CS/UOS	Location
81920198	8"	635483011146	RN114B	6/6	East
81920199	10"	635483011153	RN115B	6/6	National
81920200	12"	635483011160	RN116B	6/6	National

River North Caddy

Powder coated finish over steel that includes decorative tray and hidden wheels for easy moving of heavy house plants.



Item #	Desc	UPC	Vendor	CS/UOS	Location
81920196	14" Black	635483011122	RN112B	6/6	National
81920197	17" Black	635483011139	RN113B	6/6	National

Succulent Planter

Large Succulent Planter with weathered galvanized finish. 12" Diameter x 6" Height. Planting area: 12"x12"x3" deep



Item #	Desc	UPC	Vendor	CS/UOS	Location
81920337	Galvanized planter	702085411381	CD145L	4/4	East

French Hanging Basket With Coco Liner

Hanging Basket is 17" in diameter. Planting area is 12" diameter x 8" deep



Item #	Desc	UPC	Vendor	CS/UOS	Location
81920028	Natural Patina	702085400224	BA131	6/6	National
81920029	Black	702085405908	BA131-BLK	6/6	National

Imperial Hanging Basket with Coco Liner

16" diameter x 9" deep basket



Item #	Desc	UPC	Vendor	CS/UOS	Location
81920053	Black	702085405953	BA217-BLK	6/6	East

Solera Basket With Coco Liner

Handle on handled basket is removable for easy planting. Height with handle is 19" - Planting area 15" x 8" - Two colors to choose from: black or natural patina. Hanging basket planting area 15" x 8" available in one color, black



Item #	Desc	UPC	Vendor	CS/UOS	Location
81920037	Black Hanging Basket	702085405922	BA203-BLK	6/6	East
81920043	Black Handle Basket	702085405946	BA206-BLK	6/6	East
81920042	Patina Handle Basket	702085402068	BA206	6/6	East



Wall Planter Variety Pack

Contains 2 of each: Butterfly (WB146), Dragonfly (WB142), Floral (WB148).



Item #	Desc	UPC	Vendor	CS/UOS	Location
81920307	14" Natural Patina	702085408589	WBVP101	6/6	East
81920308	14" Black	702085408596	WBVP101-BLK	6/6	East

Mini Round Basket With Coco Liner



Item #	Desc	UPC	Vendor	CS/UOS	Location
81920021	Black	702085406066	BA120-BLK	8/8	National
81920020	Natural Patina	702085400132	BA120	8/8	National

2025

Peacock Wall Basket With Coco Liner

Planting area 15" x 8" x 8"
Basket size 18" x 8" x 19"



Item #	Desc	UPC	Vendor	CS/UOS	Location
81920257	Black	702085405991	WB107-BLK	6/6	East
81920256	Natural Patina	702085400187	WB107	6/6	East

Rectangular Twist Basket With Coco Liner

Planting area is 13" x 9" x 7" deep
13" height with handle



Item #	Desc	UPC	Vendor	CS/UOS	Location
81920026	Black	702085405892	BA127-BLK	6/6	East
81920025	Natural Patina	702085400149	BA127	6/6	East

Daisy Wall Basket with Coco Liner

Planting area: 13" x 8" x 7"
Basket size: 15" x 9" x 25"



Item #	Desc	UPC	Vendor	CS/UOS	Location
81920279	Black	702085406004	WB135-BLK	6/6	East
81920278	Natural Patina	702085400194	WB135	6/6	East



Hanging basket variety pack

Hanging basket variety pack in black finish features 2 each floral, daisy, arch style. Basket size 16" diameter x 9" deep

Item #	Desc	UPC	Vendor	CS/UOS	Location
81920070	2 each hanging	702085408558	BAVP101-BLK	6/6	East

Finial X Wall Basket with Coco Liner

Planting area: 15" x 8" x 11"
Basket size: 22" x 11" x 37"



Item #	Desc	UPC	Vendor	CS/UOS	Location
81920276	Black	702085405762	WB134-BLK	4/4	East
81920275	Natural Patina	702085400200	WB134	4/4	East

Handled Basket Variety pack

Handled Basket Variety pack in black finish features 2 each floral, daisy, and arch styles. Basket size 16" diameter x 9" deep - Height with handle attached 19"



Item #	Desc	UPC	Vendor	CS/UOS	Location
81920072	2 each handled	702085408572	BAVP102-BLK	6/6	East



Round Corrugated Tub Planters

Set of 3 planters with drainage holes
 Small: 14"W x 11"D
 Medium: 15"W x 12"D
 Large: 17"W x 14"D
 2 sets of 3 per case



Item #	Desc	UPC	Vendor	CS/UOS	Location
81920108	S:14" M:15" L: 17"	702085410216	CD123	2/2	East

Oval Corrugated Tub Planters

Set of 3 planters with drainage holes
 Small: 13"W x 10"D x 10"H
 Medium: 15"W x 12"D x 11"H
 Large: 17"W x 14"D x 12"H
 2 sets of 3 per case



Item #	Desc	UPC	Vendor	CS/UOS	Location
81920101	S:13" M:15" L:17"	702085407841	CD112	2/2	East



Venetian Planters

Item #	Desc	UPC	Vendor	CS/UOS	Location
81920331	A Wall	702085411367	CD129	6/6	National
81920104	B Round-Set of 3	702085408442	CD118	2/2	East
81920103	C S:12" M:17" L:21"	702085408435	CD117	2/2	East
81920105	D 20"x7"x6"	702085408459	CD119	6/6	East
81920113	E Sq:7" Ro:7" Ov:9"	702085410070	CD130	18/18	East

DECORATIVE METAL PLANTERS

Sturdy construction | Great for indoor and outdoor use.

Fancy Bicycle Planter

22" L x 10" W x 19" H - Holds 10" pot (pot not included) Natural Patina



Item #	Desc	UPC	Vendor	CS/UOS	Location
81920090	Bicycle	702085400279	BK101	4/4	East

Pitcher Planters

Corrugated Pitcher Planters with drainage holes. 11" diam. base x 12" H (Holds 10" pot, not included)



Item #	Desc	UPC	Vendor	CS/UOS	Location
81920102	Corrugated	702085408152	CD115	4/4	East
81920334	Silver/white	702085411329	CD142	4/4	East

All I Need Metal Planters

Small: 9" x 7"
 Medium: 10" x 8"
 Large: 12" x 9"
 2 sets of 3 per case with drainage holes



Item #	Desc	UPC	Vendor	CS/UOS	Location
81920111	S: 9" M: 10" L: 12"	702085409593	CD127	2/2	East

Dairy Jug Variety Pack

Rustic galvanized Dairy Jug Planters with drainage hole. Cream/Galvanized
 4 sets of 2 per case.
 Small: 9" diam. x 11" H (Holds 8" pot, not included)
 Large: 12" diam. x 14" H (Holds 10" pot, not included)



Item #	Desc	UPC	Vendor	CS/UOS	Location
81920332	Cream & Galv Set of 2	702085410117	CD131	4/4	East



Standard Terra Cotta Pot (A)

Features both traditional color and design. Functional hole in the bottom allows for bottom watering. Contributes to the health of your plant.

Item #	Desc	UPC	Vendor	CS/UOS	Location
80620948	2.8" - 7cm	726232010609	01070FZ	48/48	National
80620008	4.3" - 11cm	726232011002	01110PZ	24/24	National
80621088	5.1" - 13cm	726232011200	01130PZ	24/24	National
80620009	5.9" - 15cm	726232011408	M8090PZ	20/20	National
80620010	6.3" - 16cm	726232011507	M8700PZ	20/20	National
80620011	8.3" - 21cm	726232012009	M8300PZ	12/12	National
80620012	9.1" - 23cm	726232012207	01230PZ	6/6	National
80621089	9.9" - 25cm	726232012405	M9310PZ	8/8	National
80620847	10" - 26cm	726232012603	M9510PZ	6/6	National
80620848	12.2" - 31cm	726232013006	M9060PZ	3/3	National
80620849	13.8" - 35cm	726232013402	M9520PZ	2/2	National
80621077	16.9" - 43cm	726232260981	M8590YA	30/30	West
80621081	18.1" - 46cm	726232260998	M9150YZ	20/20	West

Standard Terra Cotta Saucer (B)

Item #	Desc	UPC	Vendor	CS/UOS	Location
80620758	2.8" - 7cm	726232240716	87071PZ	18/18	National
80620058	4.3" - 11cm	726232241010	M8190PZ	24/24	National
80621097	5.1"	726232241218	87130PZ	18/18	National
80620059	5.9" - 15cm	726232241416	M8210PZ	20/20	National
80620060	6.7" - 17cm	726232241614	M8220PZ	20/20	National
80620061	7.5" - 19cm	726232241812	M8230PZ	16/16	National
80620062	8.3" - 21cm	726232242017	M8240PZ	12/12	National
80620064	9.8" - 25cm	726232242413	87250PZ	12/12	National
80620065	11.4" - 29cm	726232242819	87290PZ	9/9	National
80620863	18.1" - 46cm	726232244516	87460PZ	3/3	National

Garden Bell Pot (C)

Item #	Desc	UPC	Vendor	CS/UOS	Retail
80620226	8.3" - 21cm	726232183730	2Q210PZ	12/12	National

Orchid Pot (D)

The pot features durable clay construction and has drainage holes that prevent the buildup of excess water.

Item #	Desc	UPC	Vendor	CS/UOS	Location
80620233	6.7" - 17cm	7262322761709	M8990PZ	24/24	National
80621090	5.3"	726232761303	76130PZ	24/24	National
80620234	8.3" - 21cm	726232762102	M9030PZ	12/12	National

Border Cylinder (E)

Item #	Desc	UPC	Vendor	CS/UOS	Location
80620756	3.1" - 8cm	726232110705	0P080PZ	24/24	National
80620034	4.7" - 12cm	726232005599	0P120PZ	16/16	National
80620035	5.5" - 14cm	726232111207	0P140PZ	20/20	National
80620036	7.1" - 18cm	726232005605	0P180PZ	8/8	National

Azalea Terra Cotta Pot (F)

Features both traditional color and design. Functional hole in the bottom allows for bottom watering. Contributes to the health of your plant.

Item #	Desc	UPC	Vendor	CS/UOS	Location
80620017	4.3" - 11cm	726232021001	M8130PZ	24/24	National
80620018	6.7" - 17cm	726232021605	M8140PZ	20/20	National
80620020	8.3" - 21cm	726232022008	M8370PZ	12/12	National
80620850	10" - 26cm	726232022602	02270PZ	5/5	National

Standard Pot Mini (G)

Item #	Desc	UPC	Vendor	CS/UOS	Location
80620498	1.6" - 4cm	726232010302	01040FZ	48/48	National
80620499	2.0" - 5cm	726232010401	01050FZ	48/48	National
80620504	3.5" - 9cm	726232013815	01090PZ	36/36	National



Graphite Standard Terra Cotta Pot (A)

Moka Chocolate Terra Cotta Clay Tapered Planter. Features both rich color and design. Functional hole in the bottom allows for bottom watering.

Item #	Desc	UPC	Vendor	CS/UOS	Location
80620074	4.3" - 11cm	726232924838	0111CPZ	24/24	National
80620075	5.9" - 15cm	726232922612	0115CPZ	24/24	National
80620076	8.3" - 21cm	726232966012	M830CPZ	12/12	National

Graphite Saucer (B)

Item #	Desc	UPC	Vendor	CS/UOS	Location
80620086	4.3" - 11cm	726232925583	8711CPZ	24/24	National
80620087	5.9" - 15cm	726232925668	8715CPZ	24/24	National
80620088	6.7" - 17cm	726232633853	8717CPZ	24/24	National
80620089	8.3" - 21cm	726232633884	8721CPZ	24/24	National
80620090	9.1" - 23cm	726232620976	8723CPZ	16/16	National

Graphite Cono (C)

Item #	Desc	UPC	Vendor	CS/UOS	Location
80620069	6.3" - 16cm	726232952527	M895CPZ	24/24	National
80620071	10.2" - 26cm box of 6	726232925194	3R26CFZ	6/6	National
80621178	10.2" - 26cm bundle of 3	726232925194	M953CPZ	3/3	National

Graphite Smooth Clay Bowl (D)

Item #	Desc	UPC	Vendor	CS/UOS	Location
80620083	9.06" - 23cm	726232925064	M910CFZ	6/6	National
80620084	10.6" - 27cm	726232925101	M911CFZ	3/3	National

Half Cone Cotto

All natural pot that is the gardeners choice



Item #	Desc	UPC	Vendor	CS/UOS	Location
80621072	4.3"	726232924838	70U40PZ	24/24	National
80621073	5.5"	726232922612	70U10PZ	10/10	National
80621074	7.5"	726232966012	70U20PZ	6/6	National

Cabo Planter



Item #	Desc	UPC	Vendor	CS/UOS	Location
80620227	4.7"	726232330936	4L120PZ	16/16	National
80620228	6.7"	726232330950	4L170PZ	12/12	National
80620229	7.5"	726232330974	4L190PZ	6/6	National
80620230	10.2"	726232330998	4L260PZ	4/4	National
80620231	11.8"	726232329602	4L300PZ	2/2	National

Heavy Rim Red Clay



Item #	Desc	UPC	Vendor	CS/UOS	Location
80621084	14.6"	726232313007	0Q370YZ	1/1	West
80621085	16.5"	726232313502	0Q420YZ	1/1	West
80621086	18.75"	726232314004	0Q470YZ	1/1	West
80621087	20.45"	726232314509	0Q520YZ	1/1	West

Vasum Duo



Item #	Desc	UPC	Vendor	CS/UOS	Location
80620526	6.7" Graphite	726232544753	5017JP98Z	16/16	National
80621102	6.7" Blush	726232543671	5017WP98Z	16/16	National
80620527	8.3" Graphite	726232544814	5021JP98Z	10/10	National
80621103	8.27" Blush	726232543787	5021WP98Z	10/10	National

Standard Grafite Pot



Item #	Desc	UPC	Vendor	CS/UOS	Location
80621112	3.5" - 9cm	191942014016	0109CPZ	36/36	National



Delisle Secchi-Ganau Mix Pallet

Item #	Desc	UPC	Vendor	CS/UOS	Location
80620945	48 pieces	191942025425	32M355	1/1	National



15.76"x15.76"x15.58"
13.2"x13.2"x12.61"
10.64"x10.64"x10.05"

Mixed Seed Planters

Item #	Desc	Vendor	CS/UOS	Location
80620820	54 pieces	32M405	1/1	East



Acampe Pallet

Item #	Desc	Vendor	CS/UOS	Location
80620817	8pc 18" 15" 13" Blue & Green	MIX4	1/1	East



Mix 4 Assortment

Item #	Desc	Vendor	CS/UOS	Location
80620823	36 pieces	MIX4	1/1	East



Succulent Planters Assortment

Item #	Desc	UPC	Vendor	CS/UOS	Location
80620966	48 pc 3.8"	191942056771	32M409F	1/1	East



Mix Dairy Planter Assortment

Item #	Desc	UPC	Vendor	CS/UOS	Location
80620999	54pcs 14.6" 11" 8.7"	191942056108	32M406	1/1	East



MORE OPTIONS TO

CONTAIN YOURSELF

Complete your retail offering with our full lineup of greenhouse and nursery containers. Griffin proudly represents top manufacturers including HC Companies (Dillen-ITML), T.O. Plastics, Nursery Supplies, Classic Home & Garden and many others.

Item	Size	Item #
Dillen 6" azalea pot, green	560/carton	48-7421
Kord 8" traditional bulb pan, green	96/case	50-1696
NSI 400C 1-gallon custom, black	92/stack	41PT400CN2
NSI 1200C 3-gallon custom, black	56/stack	41PT1200CN3

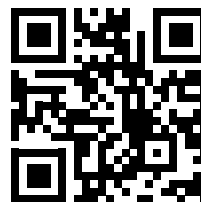



Round Plant Dolly

Move both small and large plants indoors and outdoors with ease. Rubber wheels and steel casters. (The 16" has 5 wheels)

Item #	Desc	UPC	Vendor	CS/UOS	Location
82420033	12" Black w/ no hole	837839003212	DEV3012B	8/8	National
82420034	12" Espresso w/ no hole	837839003335	DEV3012EX	8/8	National
82420035	12" Gray Mist w/ no hole	837839003304	DEV3012GM	8/8	National
82420032	12" Terra Cotta w/ no hole	837839003069	DEV3012	8/8	National
82420024	16" Black w/ no hole	837839003410	DEV3000BNH	8/8	National
82420029	16" Terra Cotta w/ no hole	837839003403	DEV3000PNH	8/8	National
82420023	16" Black	837839003229	DEV3000B	8/8	National
82420025	16" Espresso	837839009917	DEV3000EX	8/8	National
82420026	16" Gray Mist	837839003311	DEV3000GM	8/8	National
82420028	16" Terra Cotta	837839003007	DEV3000P	8/8	National
82420018	24" Black	837839003236	DEV2400B	4/4	West
82420017	24" Terra Cotta	837839001218	DEV2400	4/4	West

Plant Stand

Protect your floors and decks from stains with the Plant Stand. Constructed with quality materials, this weather resistant Plant Stand will not deteriorate in harsh weather conditions and will last for years to come.



Item #	Desc	UPC	Vendor	CS/UOS	Location
82420069	24" - Espresso	837839001287	DEV-PL-ST-ES-24	4/4	West

Square Plant Dolly with Handles

Easily move heavy plants with the DeVault Square Plant Dolly. Designed with steel swivel casters and rubber wheels, it allows large plants to be moved safely and with ease. Constructed with a polyethylene base, this weather resistant Plant Dolly will not deteriorate in harsh weather conditions and will last for years to come.



Item #	Desc	UPC	Vendor	CS/UOS	Location
82420048	16" - Black	837839008354	DEVSQH16BL	8/8	West



Oval Planter

These Oval Wooden Planters made from high quality wood, using tongue and groove construction techniques and reinforced with steel bands for extra stability. Featuring two steel handles, these wooden planters are also weather resistant. When you add dirt and plants or flowers then water, the planters will expand for a tight fit. Wooden Oval Planters 2 sets of 4 per case. 12"x7"x5" | 15"x9"x6" | 18"x11"x7" | 20"x12"x8"

Item #	Desc	UPC	Vendor	CS/UOS	Location
82420057	Small 12"x7"x5"	837839006053	DEVBP214.01	6/6	National
82420049	Set of 4	837839002147	DEVBP214	1/1	National



Whiskey Barrel Planter

Well-constructed planter with a stained finish. Planter tightens naturally when filled with dirt and water. DeVault Enterprises 6 Piece Wooden Whiskey Barrel Planter Set includes 6 different-sized planters to accommodate different-sized plants. Constructed of weatherproof fir, these planters will look great in your yard or on your deck. 10"x10"x8" | 12"x12"x10" | 15"x15"x12" | 17"x17"x14" | 20"x20"x15" | 23"x23"x17"

Item #	Desc	UPC	Vendor	CS/UOS	Location
82420071	Large 23"x23"x17"	837839007128	DEVBP213.01	5/5	National
82420058	Set of 6	837839002086	DEVBP208	1/1	National





Leader in Horticultural Containers

Tahoe Planter

Made from durable and unique proprietary blend of resins. The texture gives the illusion of aged wood without the fragility and weight. Features a removable drain plug. Great for indoor or outdoor use.



Item #	Desc	UPC	Vendor	CS/UOS	Location
80282163	15" Slate	770932836120	KTS15000A55	4/4	National

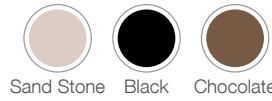

Venetian Flower Box

Add beauty to balconies, patios, walls, fences, and window sills with the durable, light-weight Venetian Window Box. Includes removable drain plugs.

Item #	Desc	UPC	Vendor	CS/UOS	Location
80280036	18" Clay	032903128185	VNP18000E35	6/6	National
80280043	24" Clay	032903128246	VNP24000E35	6/6	National
80280044	24" Sand Stone	032903453423	VNP24000A34	6/6	National
80282119	24" Black	032903913002	VNP24000G18	6/6	West
80290136	24" Chocolate	032903002874	VNP24000E21	6/6	West
80280051	30" Clay	032903128307	VNP30000E35	6/6	National
80282120	30" Black	032903913033	VNP30000G18	6/6	West
80280793	30" Chocolate	032903002904	VNP30000E21	6/6	West

2025

Terrazzo Saucer

Elegant and resilient, Terrazzo round planters combine the look of authentic Italian terra cotta with the benefits of resin. Unique bottom-channel design provides excellent drainage.



Black Granite

Item #	Desc	UPC	Vendor	CS/UOS	Location
80282000	42" Terra Cotta	770932835178	STZ42000E35	1/1	East
80282001	42" Black Granite	770932835185	STZ42000G21	1/1	East

Venetian Box Tray

Add beauty to your window box with this window box saucer.

Item #	Desc	UPC	Vendor	CS/UOS	Location
80280024	24" Clay	032903123241	SVN24000E35	6/6	National
80282122	24" Black	770932836939	SVN24000G18	6/6	West
80280797	24" Chocolate	032903002362	SVN24000E21	6/6	West
80282123	30" Black	770932836946	SVN30000G18	6/6	West
80280800	30" Chocolate	032903002430	SVN30000E21	6/6	West

Nursery Containers

These pots are mainstay in the lawn and garden industry. Great for all your potting needs. Strong rims for handling. Includes drainage holes.



Item #	Desc	UPC	Vendor	CS/UOS	Location
80282009	#2 Black	56554205057	NSB002G0G18	50/50	National
80282010	#3 Black	56554105050	NSR003G0G18	25/25	National

Deck Rail Planter

The deck rail box is designed with thick, durable plastic wall construction. Features easy to remove drain plugs for maximum drainage. Earth tone color choices perfect for outdoor spaces. 24" L x 12" W. Fits both 2" x 4" and 2" x 6" deck rails.



Item #	Desc	UPC	Vendor	CS/UOS	Location
80282114	24" - Sandstone	032903914856	SPX24DB0A34	5/5	National
80290131	24" - Chocolate	770932002693	SPX24DB0E21	5/5	National
80282116	24" - Clay	032903914849	SPX24DB0E35	5/5	National
80282117	24" - Black	770932836861	SPX24DB0G18	5/5	National

Olympia Urn

Inspired by ancient urns, the elegant rings and majestic contours of the Olympia Urn create the ideal planter to add to any outdoor setting. Works well on driveways, flanking a garage door, or an exterior door. Timeless design with long lasting plastic construction.



Item #	Desc	UPC	Vendor	CS/UOS	Location
80290210	16"	56554731051	RUA16000G18	8/8	National

Romana Deck Planter

Removable drain plugs for indoor and outdoor use. Raised feet allow for drainage and air circulation. Larger size perfect for landscaping, patios and pool side settings. Coordinates with Romana Deck Planter.



Item #	Desc	UPC	Vendor	CS/UOS	Location
80282113	28" - Black	770932836854	ROP28000G18	5/5	West
80280746	28" - Chocolate	032903224849	ROP28000E21	5/5	West



Leader in Horticultural Containers



Panterra Oval Pot

These distinctive oval shaped planters have a textured finish and are a popular choice for colorful flowering arrangements, herbs, annuals and tropical plants.

Item #	Desc	UPC	Vendor	CS/UOS	Location
80280785	20" Clay	770932702036	PAP20000E22	24/24	National
80280784	20" Green	770932702005	PAP20000B71	24/24	National

Charcoal Aspen Planters

Fiberglass construction is more rigid than plastic and less breakable than ceramic. Contemporary design with grooved texture and globe shape. Durable and weather resistant.



Item #	Desc	UPC	Vendor	CS/UOS	Location
80282394	15", 15", & 17.5" 3 pack	770932839794	ANP00001A39	3/3	National
80282383	12"	770932839107	ANP12000A39	1/1	National

Panterra Saucer

Made from plastic, these containers are very durable and lightweight. This makes them great for performing outdoor container gardening on your patio, porch, or deck. These trays will not crack nor color-fade over time.



Item #	Desc	UPC	Vendor	CS/UOS	Location
80280768	6"	770932786036	SPN06000E22	18/18	National
80280771	8"	770932788030	SPN08000E22	18/18	National

Avino Square Planter

These plastic containers are very durable and lightweight. This makes them great for performing outdoor gardening on your patio, porch, or deck. These containers will not crack nor color-fade over time.



Item #	Desc	UPC	Vendor	CS/UOS	Location
80290179	13" Oxidized Black	056554105807	AOS13000P29	6/6	National
80290219	16" Oxidized Black	056554105814	AOS16000P29	6/6	National

Green Grower Pot

An economical poly growing pot for new plants and cuttings. Ideal for a wide variety of planting applications. Durable and long lasting.



Item #	Desc	UPC	Vendor	CS/UOS	Location
80281515	4"	770932100009	STR04000B71	36/36	West
80281519	8"	770932099006	AZE08000B71	18/18	National
80281521	10"	770932010001	AZE10001B71	18/18	West
80281523	12"	770932011008	AZN12000B71	12/12	West

Jack O'Lantern Pot

Happy and scary face painted on either side, great for the fall season. Fiber Clay with drainage holes.



Item #	Desc	UPC	Vendor	CS/UOS	Location
80281501	10"	032903915167	PPF10001Y28C008	8/8	National

Green Grower Plastic Saucer



Item #	Desc	UPC	Vendor	CS/UOS	Location
80281525	4"	770932042002	SNA04000B71	24/24	West
80281527	6"	770932043009	SNA06000B71	36/36	West
80281529	8"	770932045003	SNA08000B71	18/18	West
80281531	10"	770932046000	SNA10000B71	24/24	West

Eclipse Square Planter

These square planters come in several sizes and are great for indoor houseplants, as well as outdoor gardening on your patio, porch or deck. Use them to grow vegetables, flowers, herbs, snake plants and more.



Item #	Desc	UPC	Vendor	CS/UOS	Location
80282957	10" Black	770932847560	ECP10050G18	20/20	National



Leader in Horticultural Containers



Clay



Euro Hanging Basket

Euro Hanging Basket has a basket rim for hooks to attach to, making it an effective way to display plants.

Item #	Desc	UPC	Vendor	CS/UOS	Location
80282273	12" White	770932839763	HSI12000A10	12/12	West
80282275	12" Clay	770932839787	HSI12000E24	12/12	West



Caribbean Pot

Capture the soul and style of the Caribbean with these light-weight, durable Caribbean Planters. Removable drain plugs for indoor or outdoor use. Planters can be partnered with Classic Saucers. Contoured base protects plants from excess water.

Item #	Desc	UPC	Vendor	CS/UOS	Location
80281832	12" Clay	032903123128	CNA12000E35	12/12	National

2025

Metallic Hanging Basket

The metallic hanging baskets are beautiful and functional, the perfect addition to any indoor/outdoor setting.



Item #	Desc	UPC	Vendor	CS/UOS	Location
80282518	12" Bronze	770932840325	HBM12000H22	10/10	West



Clay



Chocolate



Warm Gray

Garden Bowl

Perfect for shallow rooted plantings and colorful annuals. For maximum appeal, add this Garden Bowl to tables, ledges, stands, or any kind of posts. Removable drain plugs allow for indoor or outdoor use. Compatible with Classic Saucers.

Item #	Desc	UPC	Vendor	CS/UOS	Location
80280022	12" Clay	032903127126	GAB12000E35	12/12	National
80290085	12" Chocolate	032903001914	GAB12000E21	12/12	West
80282477	12" Warm Gray	770932840202	GAB12000A42	12/12	West
80280032	14" Clay	032903127140	GAB14000E35	12/12	National
80290111	18" Chocolate	032903003130	GAB18000E21	6/6	National
80282479	18" Warm Gray	770932839879	GAB18000A42	6/6	West



Capri Bowl

Get the look of ceramic and concrete, without the fragility, with these attractive and modern succulent planters made of durable plastic. The planters feature a drain hole for proper succulent care.

Item #	Desc	UPC	Vendor	CS/UOS	Location
80282501	6" Vanilla Bisque	770932840653	CSB06000A58	20/20	National
80282502	6" Artisan Taupe	770932840677	CSB06000E67	20/20	National
80282503	6" Faux Concrete	770932840691	CSB06000G28	20/20	National
80282504	8" Vanilla Bisque	770932840660	CSB08000A58	20/20	National
80282505	8" Artisan Taupe	770932840684	CSB08000E67	20/20	National
80282506	8" Faux Concrete	770932840707	CSB08000G28	20/20	National



Sprite Succulent Pot

Plastic succulent planter has the look of ceramic and concrete without the fragility. Features a drain hole for proper succulent drainage and care.

Item #	Desc	UPC	Vendor	CS/UOS	Location
80282495	2.5" Vanilla Bisque	770932840790	SSP02500A58	20/20	National
80282496	2.5" Artisan Taupe	770932840813	SSP02500E67	20/20	National
80282497	2.5" Faux Concrete	770932840837	SSP02500G28	20/20	National
80282851	2.5" Faux Turquoise	770932844149	SSP02500K22	20/20	National
80282850	2.5" Blush	770932844125	SSP02500K21	20/20	National
80282498	3" Vanilla Bisque	770932840806	SSP03000A58	20/20	National
80282499	3" Artisan Taupe	770932840820	SSP03000E67	20/20	National
80282500	3" Faux Concrete	770932840844	SSP03000G28	20/20	National
80282898	3" Faux Concrete/Copper	770932841360	SSP03000K-20C040LRCOY	40/40	National
80282855	5" Artisan Taupe	770932844026	SSP05000E67	12/12	West
80282858	5" Faux Turquoise	770932844101	SSP05000K22	12/12	West
80282859	7" Vanilla Bisque	770932844057	SSP07000A58	12/12	National



Leader in Horticultural Containers

Santa Fe Square Planter

Decorate the exterior of your home and bring your front/backyard to life with the help of The Santa Fe Square Self-Watering Planter. Perfect for succulents, vegetables, flowers, and anything in between, this portable house planter is excellent for any indoor or outdoor setting.



Item #	Desc	UPC	Vendor	CS/UOS	Location
80282350	12" Pebble Gray	770932839275	SKS12000A56	10/10	West
80282351	12" Cavern Clay	770932839251	SKS12000E66	10/10	West
80282352	12" Black	770932839237	SKS12000G27	10/10	West
80282382	16" Black	770932839244	SKS16000G27	8/8	West

Curio Planter w/ Geometric Stand

Contemporary, indoor, decorative planter that will brighten any room. The included reversable plastic stand painted with a metallic finish provides the ability to display this planter in multiple ways. Perfect for center pieces, book shelves, windows and counter tops. Recommended for succulents, herbs, tropical plants and other indoor varieties.



Item #	Desc	UPC	Vendor	CS/UOS	Location
80282603	4" Blush	770932844200	CUP04000K21	10/10	National
80282604	4" Lavender	770932844248	CUP04000K23	10/10	National
80282605	4" Cottage Stone	770932844224	CUP04000K25	10/10	National
80282606	4" Honey	770932844262	CUP04000K26	10/10	National
80282607	5" Artisan Taupe	770932844934	CUP05000E67	10/10	National
80282608	5" Blush	770932844965	CUP05000K21	10/10	National
80282609	5" Lavender	770932844651	CUP05000K23	10/10	National
80282610	5" Cottage Stone	770932844996	CUP05000K25	10/10	National
80282611	5" Honey	770932844644	CUP05000K26	10/10	National

8" Kaleidoscope Planter

Premium plastic modular planter can be displayed individually each planter has a removable saucer ideal for succulents or shallow rooted planted.



Item #	Desc	UPC	Vendor	CS/UOS	Location
80282643	Vanilla Bisque	770932844170	KDP08000A58	6/6	National



Orion Pot

Modern two-toned faux finish planter with contemporary raised base design. Self watering two-piece planter.

Item #	Desc	UPC	Vendor	CS/UOS	Location
80282900	6"-Sage	770932845931	ORP06000K29	16/16	National
80282899	6"-Greige	770932845900	ORP06000K28	16/16	National
80282901	6"-Clay	770932845962	ORP06000K30	16/16	National
80282903	8"-Sage	770932846020	ORP08000K29	12/12	National
80282902	8"-Greige	770932845993	ORP08000K28	12/12	National
80282904	8"-Clay	770932846051	ORP08000K30	12/12	National
80282906	10" -Sage	770932846112	ORP10000K29	12/12	National
80282905	10" -Greige	770932846082	ORP10000K28	12/12	National
80282907	10" -Clay	770932846143	ORP10000K30	12/12	National

8" Pixie Succulent Stacking Planter

Mini stacking planter includes three planting layers and a saucer to protect surfaces. Includes a drain hole in each cup on every level for proper succulent care. Holds a minimum of 10 planted succulents. Coordinates with our complete line of succulent planters sold separately.



Vanilla Bisque

Item #	Desc	UPC	Vendor	CS/UOS	Location
80282493	Vanilla Bisque	770932840776	SPP08000A58	4/4	National
80282494	Artisan Taupe	770932840783	SPP08000E67	4/4	National



Terrace Planter

Includes three planting layers and saucer for indoor and outdoor use. Each tier has a self-watering reservoir for even water distribution throughout each layer. Easy set-up, no hardware required. Plant annuals, perennials, herbs and more.



Warm Gray

Item #	Desc	UPC	Vendor	CS/UOS	Location
80282507	Warm Gray	770932840295	RZ.MT160A42	2/2	National
80282508	Iced Mocha	770932840301	RZ.MT160A57	2/2	National

PRIMA SERIES

These plastic containers are very durable and lightweight. This makes them great for performing outdoor gardening on your patio, porch, or deck. These containers will not crack nor color-fade over time.



Leader in Horticultural Containers

Honey



Cappuccino



8" Planters

Item #	Desc	UPC	Vendor	CS/UOS	Location
80282661	8"-Sand Stone	770932842497	PCP08005A34	24/24	National
80282665	8"-Dusty Teal	770932842091	PCP08005DE1	24/24	National
80282667	8"-Chocolate	770932841933	PCP08005E21	24/24	National
80282662	8"-Warm Gray	770932842572	PCP08005A42	24/24	National
80282664	8"-Honey	770932842251	PCP08005CXX	24/24	National
80282666	8"-Twilight Blue	770932842411	PCP08005DE6	24/24	National
80282663	8"-Evergreen	770932842176	PCP08005B91	24/24	National
80282668	8"-Cappuccino	770932841858	PCP08005E29	24/24	National
80282669	8"-Terra Cotta	770932842015	PCP08005E35	24/24	National
80282670	8"-Marsala	770932842336	PCP08005FD2	24/24	National
80282671	8"-Black	770932841773	PCP08005G18	24/24	National

8" Saucers

Item #	Desc	UPC	Vendor	CS/UOS	Location
80282749	8"-Sand Stone	770932843371	PCS08005A34	24/24	East
80282751	8"-Evergreen	770932843050	PCS08005B91	24/24	East
80282752	8"-Honey	770932843135	PCS08005CXX	24/24	East
80282754	8"-Twilight Blue	770932843296	PCS08005DE6	24/24	East
80282750	8"-Warm Gray	770932843456	PCS08005A42	24/24	East
80282757	8"-Terra Cotta	770932842893	PCS08005E35	24/24	East
80282753	8"-Dusty Teal	770932842978	PCS08005DE1	24/24	East
80282755	8"-Chocolate	770932842817	PCS08005E21	24/24	East
80282756	8"-Cappuccino	770932842732	PCS08005E29	24/24	East
80282758	8"-Marsala	770932843210	PCS08005FD2	24/24	East
80282759	8"-Black	770932842657	PCS08005G18	24/24	East

6" Planters

Item #	Desc	UPC	Vendor	CS/UOS	Location
80282654	6"-Dusty Teal	770932842084	PCP06005DE1	24/24	National
80282655	6"-Twilight Blue	770932842404	PCP06005DE6	24/24	National
80282650	6"-Sand Stone	770932842480	PCP06005A34	24/24	National
80282651	6"-Warm Gray	770932842565	PCP06005A42	24/24	National
80282653	6"-Honey	770932842244	PCP06005CXX	24/24	National
80282657	6"-Cappuccino	770932841841	PCP06005E29	24/24	National
80282659	6"-Marsala	770932842329	PCP06005FD2	24/24	National
80282660	6"-Black	770932841766	PCP06005G18	24/24	National
80282652	6"-Evergreen	770932842169	PCP06005B91	24/24	National
80282656	6"-Chocolate	770932841926	PCP06005E21	24/24	National
80282658	6"-Terra Cotta	770932842008	PCP06005E35	24/24	National

6" Saucers

Item #	Desc	UPC	Vendor	CS/UOS	Location
80282743	6"-Twilight Blue	770932843289	PCS06005DE6	24/24	East
80282742	6"-Dusty Teal	770932842961	PCS06005DE1	24/24	East
80282739	6"-Warm Gray	770932843449	PCS06005A42	24/24	National
80282741	6"-Honey	770932843128	PCS06005CXX	24/24	East
80282745	6"-Cappuccino	770932842725	PCS06005E29	24/24	National
80282746	6"-Terra Cotta	770932842886	PCS06005E35	24/24	National
80282748	6"-Black	770932842640	PCS06005G18	24/24	National
80282738	6"-Sand Stone	770932843364	PCS06005A34	24/24	East
80282740	6"-Evergreen	770932843043	PCS06005B91	24/24	East
80282744	6"-Chocolate	770932842800	PCS06005E21	24/24	National
80282747	6"-Marsala	770932843203	PCS06005FD2	24/24	East





Leader in
Horticultural
Containers



12" Planters

Item #	Desc	UPC	Vendor	CS/UOS	Location
80282688	12"-Twilight Blue	770932842435	PCP12005DE6	12/12	National
80282683	12"-Sand Stone	770932842510	PCP12005A34	12/12	National
80282685	12"-Evergreen	770932842190	PCP12005B91	12/12	National
80282686	12"-Honey	770932842275	PCP12005CXX	12/12	National
80282687	12"-Dusty Teal	770932842114	PCP12005DE1	12/12	National
80282690	12"-Cappuccino	770932841872	PCP12005E29	12/12	National
80282684	12"-Warm Gray	770932842596	PCP12005A42	12/12	National
80282689	12"-Chocolate	770932841957	PCP12005E21	12/12	National
80282693	12"-Black	770932841797	PCP12005G18	12/12	National
80282691	12"-Terra Cotta	770932842039	PCP12005E35	12/12	National
80282692	12"-Marsala	770932842350	PCP12005FD2	12/12	National

10" Planters

Item #	Desc	UPC	Vendor	CS/UOS	Location
80282675	10"-Honey	770932842268	PCP10005CXX	12/12	National
80282677	10"-Twilight Blue	770932842428	PCP10005DE6	12/12	National
80282673	10"-Warm Gray	770932842589	PCP10005A42	12/12	National
80282682	10"-Black	770932841780	PCP10005G18	12/12	National
80282672	10"-Sand Stone	770932842503	PCP10005A34	12/12	National
80282674	10"-Evergreen	770932842183	PCP10005B91	12/12	National
80282676	10"-Dusty Teal	770932842107	PCP10005DE1	12/12	National
80282678	10"-Chocolate	770932841940	PCP10005E21	12/12	National
80282679	10"-Cappuccino	770932841865	PCP10005E29	12/12	National
80282680	10"-Terra Cotta	770932842022	PCP10005E35	12/12	National
80282681	10"-Marsala	770932842343	PCP10005FD2	12/12	National

12" Saucers

Item #	Desc	UPC	Vendor	CS/UOS	Location
80282776	12"-Twilight Blue	770932843319	PCS12005DE6	12/12	East
80282778	12"-Cappuccino	770932842756	PCS12005E29	12/12	National
80282775	12"-Dusty Teal	770932842992	PCS12005DE1	12/12	East
80282779	12"-Terra Cotta	770932842916	PCS12005E35	12/12	National
80282781	12"-Black	770932842671	PCS12005G18	12/12	National
80282771	12"-Sand Stone	770932843395	PCS12005A34	12/12	East
80282772	12"-Warm Gray	770932843470	PCS12005A42	12/12	National
80282773	12"-Evergreen	770932843074	PCS12005B91	12/12	East
80282774	12"-Honey	770932843159	PCS12005CXX	12/12	East
80282777	12"-Chocolate	770932842831	PCS12005E21	12/12	National
80282780	12"-Marsala	770932843234	PCS12005FD2	12/12	East

10" Saucers

Item #	Desc	UPC	Vendor	CS/UOS	Location
80282763	10"-Honey	770932843142	PCS10005CXX	12/12	East
80282765	10"-Twilight Blue	770932843302	PCS10005DE6	12/12	East
80282761	10"-Warm Gray	770932843463	PCS10005A42	12/12	National
80282767	10"-Cappuccino	770932842749	PCS10005E29	12/12	National
80282770	10"-Black	770932842664	PCS10005G18	12/12	National
80282760	10"-Sand Stone	770932843388	PCS10005A34	12/12	East
80282762	10"-Evergreen	770932843067	PCS10005B91	12/12	East
80282764	10"-Dusty Teal	770932842985	PCS10005DE1	12/12	East
80282766	10"-Chocolate	770932842824	PCS10005E21	12/12	East
80282768	10"-Terra Cotta	770932842909	PCS10005E35	12/12	East
80282769	10"-Marsala	770932843227	PCS10005FD2	12/12	East





Leader in Horticultural Containers



2025



16" Planters

Item #	Desc	UPC	Vendor	CS/UOS	Location
80282705	16"-Sand Stone	770932842534	PCP16005A34	12/12	National
80282706	16"-Warm Gray	770932842619	PCP16005A42	12/12	National
80282707	16"-Evergreen	770932842213	PCP16005B91	12/12	National
80282708	16"-Honey	770932842299	PCP16005CXX	12/12	National
80282709	16"-Dusty Teal	770932842138	PCP16005DE1	12/12	National
80282710	16"-Twilight Blue	770932842459	PCP16005DE6	12/12	National
80282711	16"-Chocolate	770932841971	PCP16005E21	12/12	National
80282712	16"-Cappuccino	770932841896	PCP16005E29	12/12	National
80282713	16"-Terra Cotta	770932842053	PCP16005E35	12/12	National
80282714	16"-Marsala	770932842374	PCP16005FD2	12/12	National
80282715	16"-Black	770932841810	PCP16005G18	12/12	National

14" Planters

Item #	Desc	UPC	Vendor	CS/UOS	Location
80282694	14"-Sand Stone	770932842527	PCP14005A34	12/12	National
80282695	14"-Warm Gray	770932842602	PCP14005A42	12/12	National
80282696	14"-Evergreen	770932842206	PCP14005B91	12/12	National
80282698	14"-Dusty Teal	770932842121	PCP14005DE1	12/12	National
80282700	14"-Chocolate	770932841964	PCP14005E21	12/12	National
80282697	14"-Honey	770932842282	PCP14005CXX	12/12	National
80282699	14"-Twilight Blue	770932842442	PCP14005DE6	12/12	National
80282704	14"-Black	770932841803	PCP14005G18	12/12	National
80282701	14"-Cappuccino	770932841889	PCP14005E29	12/12	National
80282702	14"-Terra Cotta	770932842046	PCP14005E35	12/12	National
80282703	14"-Marsala	770932842367	PCP14005FD2	12/12	National

16" Saucers

Item #	Desc	UPC	Vendor	CS/UOS	Location
80282799	16"-Chocolate	770932842855	PCS16005E21	12/12	National
80282793	16"-Sand Stone	770932843418	PCS16005A34	12/12	East
80282794	16"-Warm Gray	770932843494	PCS16005A42	12/12	National
80282795	16"-Evergreen	770932843098	PCS16005B91	12/12	East
80282796	16"-Honey	770932843173	PCS16005CXX	12/12	East
80282797	16"-Dusty Teal	770932843012	PCS16005DE1	12/12	East
80282798	16"-Twilight Blue	770932843333	PCS16005DE6	12/12	East
80282800	16"-Cappuccino	770932842770	PCS16005E29	12/12	National
80282801	16"-Terra Cotta	770932842930	PCS16005E35	12/12	National
80282802	16"-Marsala	770932843258	PCS16005FD2	12/12	East
80282803	16"-Black	770932842695	PCS16005G18	12/12	National

14" Saucers

Item #	Desc	UPC	Vendor	CS/UOS	Location
80282792	14"-Black	770932842688	PCS14005G18	12/12	East
80282782	14"-Sand Stone	770932843401	PCS14005A34	12/12	East
80282783	14"-Warm Gray	770932843487	PCS14005A42	12/12	East
80282784	14"-Evergreen	770932843081	PCS14005B91	12/12	East
80282785	14"-Honey	770932843166	PCS14005CXX	12/12	East
80282786	14"-Dusty Teal	770932843005	PCS14005DE1	12/12	East
80282787	14"-Twilight Blue	770932843326	PCS14005DE6	12/12	East
80282788	14"-Chocolate	770932842848	PCS14005E21	12/12	East
80282789	14"-Cappuccino	770932842763	PCS14005E29	12/12	East
80282790	14"-Terra Cotta	770932842923	PCS14005E35	12/12	East
80282791	14"-Marsala	770932843241	PCS14005FD2	12/12	East





Leader in Horticultural Containers



20" Planters

Item #	Desc	UPC	Vendor	CS/UOS	Location
80282716	20"-Sand Stone	770932842541	PCP20005A34	6/6	National
80282717	20"-Warm Gray	770932842626	PCP20005A42	6/6	National
80282718	20"-Evergreen	770932842220	PCP20005B91	6/6	National
80282719	20"-Honey	770932842305	PCP20005CXX	6/6	National
80282720	20"-Dusty Teal	770932842145	PCP20005DE1	6/6	National
80282721	20"-Twilight Blue	770932842466	PCP20005DE6	6/6	National
80282722	20"-Chocolate	770932841988	PCP20005E21	6/6	National
80282723	20"-Cappuccino	770932841902	PCP20005E29	6/6	National
80282724	20"-Terra Cotta	770932842060	PCP20005E35	6/6	National
80282725	20"-Marsala	770932842381	PCP20005FD2	6/6	National
80282726	20"-Black	770932841827	PCP20005G18	6/6	National

20" Saucers

Item #	Desc	UPC	Vendor	CS/UOS	Location
80282804	20"-Sand Stone	770932843425	PCS20005A34	6/6	East
80282805	20"-Warm Gray	770932843500	PCS20005A42	6/6	East
80282806	20"-Evergreen	770932843104	PCS20005B91	6/6	East
80282807	20"-Honey	770932843180	PCS20005CXX	6/6	East
80282808	20"-Dusty Teal	770932843029	PCS20005DE1	6/6	East
80282809	20"-Twilight Blue	770932843340	PCS20005DE6	6/6	East
80282810	20"-Chocolate	770932842862	PCS20005E21	6/6	East
80282811	20"-Cappuccino	770932842787	PCS20005E29	6/6	East
80282812	20"-Terra Cotta	770932842947	PCS20005E35	6/6	East
80282813	20"-Marsala	770932843265	PCS20005FD2	6/6	East
80282814	20"-Black	770932842701	PCS20005G18	6/6	East



24" Planters

Item #	Desc	UPC	Vendor	CS/UOS	Location
80282733	24"-Chocolate	770932841995	PCP24005E21	6/6	National
80282734	24"-Cappuccino	770932841919	PCP24005E29	6/6	National
80282727	24"-Sand Stone	770932842558	PCP24005A34	6/6	National
80282728	24"-Warm Gray	770932842633	PCP24005A42	6/6	National
80282729	24"-Evergreen	770932842237	PCP24005B91	6/6	National
80282730	24"-Honey	770932842312	PCP24005CXX	6/6	National
80282731	24"-Dusty Teal	770932842152	PCP24005DE1	6/6	National
80282732	24"-Twilight Blue	770932842473	PCP24005DE6	6/6	National
80282735	24"-Terra Cotta	770932842077	PCP24005E35	6/6	National
80282736	24"-Marsala	770932842398	PCP24005FD2	6/6	National
80282737	24"-Black	770932841834	PCP24005G18	6/6	National

24" Saucers

Item #	Desc	UPC	Vendor	CS/UOS	Location
80282815	24"-Sand Stone	770932843432	PCS24005A34	6/6	East
80282816	24"-Warm Gray	770932843517	PCS24005A42	6/6	East
80282817	24"-Evergreen	770932843111	PCS24005B91	6/6	East
80282818	24"-Honey	770932843197	PCS24005CXX	6/6	East
80282819	24"-Dusty Teal	770932843036	PCS24005DE1	6/6	East
80282820	24"-Twilight Blue	770932843357	PCS24005DE6	6/6	East
80282821	24"-Chocolate	770932842879	PCS24005E21	6/6	East
80282822	24"-Cappuccino	770932842794	PCS24005E29	6/6	East
80282823	24"-Terra Cotta	770932842954	PCS24005E35	6/6	East
80282824	24"-Marsala	770932843272	PCS24005FD2	6/6	East
80282825	24"-Black	770932842718	PCS24005G18	6/6	East





Deco Faceted Bowl

Get the look of ceramic and concrete, without the fragility, with these uniquely designed succulent planters made of durable plastic. The planters feature a drain hole for proper succulent care. The Deco Faceted Bowls come in 6" or 8" - perfect for multi-plantings. The planters coordinate with our complete line of succulent planters.

Item #	Desc	UPC	Vendor	CS/UOS	Location
80282488	6" Artisan Taupe	770932840738	DFB06000E67	24/24	National
80282489	6" Faux Concrete	770932840752	DFB06000G28	24/24	National
80282491	8" Artisan Taupe	770932840745	DFB08000E67	24/24	National
80282492	8" Faux Concrete	770932840769	DFB08000G28	24/24	National
80282490	8" Vanilla Bisque	770932840721	DFB08000A58	24/24	National

JACKSON POTTERY



New Direction Collection

Item #	Desc	Vendor	CS/UOS	Location
82220001	24 Pcs 8 sets	DG-PP-127	1/1	East



Coastal Designs Collection

Item #	Desc	Vendor	CS/UOS	Location
82220003	24 Pcs 8 sets	DG-PP-050	1/1	East



ArtStone Cache Pot Display

Comes with 24 pots, 6 of each color in Black, Grey, Terra Cotta and Taupe. A simple, practical drop in for growers and retailers.

Item #	Desc	UPC	Vendor	CS/UOS	Location
80250375	Neutral 5"	10026978708028	70802	1/1	East

Artstone Mini Planter

Great for herbs, succulents or small plants. Does not come with the Water-Minder feature. Comes in a case of 24 with an assortment of colors that include grey, white, mint and taupe (6 of each color). Dimensions: 3.12" dia x 3.5"h



Item #	Desc	UPC	Vendor	CS/UOS	Location
80250719	3" (24pieces)	10026978708103	70810	1/1	East

Artstone Napa Planter

A sleek series in a variety of colors featuring Artstone resin and stone composite with a Water-Minder reservoir. Lightweight, durable, UV and frost resistant.



Item #	Desc	UPC	Vendor	CS/UOS	Location
80250736	6" Rust	026978080622	08062	10/10	East
80250738	8" Rust	026978080822	08082	10/10	East
80250737	8" Grey	026978080806	08080	10/10	East
80250735	6" Grey	026978080608	08060	10/10	East



ArtStone Napa Bowl

Napa bowls in 10" and 12" sizes make for stunning add-ons to the ArtStone line. Succulents, fairy gardens and small herbs fare well in these round planters. Think outside the box and use Napa bowls for fruits and veggies or a unique, great gift idea!

Item #	Desc	UPC	Vendor	CS/UOS	Location
80250745	10" Grey	026978311009	31100	5/5	East
80250331	10" Black	026978311085	31108	5/5	East
80250746	10" Rust	026978311092	31109	5/5	East
80250837	10" White	026978311023	31102	5/5	East
80250117	12" Black	026978311283	31128	5/5	East
80250747	12" Grey	026978311207	31120	5/5	East



ArtStone Ella Tall Planter

This Ella Tall Planter brings beauty to every doorway, patio, deck, backyard scene, the possibilities are endless. A deeper vessel allows for larger plants, trees and shrubbery to live in a healthier planted environment. All beautiful, all durable, all practical, both indoors and out.



Item #	Desc	UPC	Vendor	CS/UOS	Location
80250056	19.5" Black	026978351982	35198	2/2	East
80250761	19.5" Rust	026978351999	35199	2/2	East
80250656	19.5" Grey	026978351906	35190	2/2	East
80250348	27.5" Black	026978352781	35278	2/2	East

ArtStone Ella Square Planter

Best selling Ella planters offer a sleek profile with clean lines and neutral tones that accentuate any space, lending a modern look to all settings.



Item #	Desc	UPC	Vendor	CS/UOS	Location
80250767	10" Low Grey	026978361004	36100	5/5	East
80250353	10" Low Black	026978361080	36108	5/5	East
80250768	12" Low Grey	026978361202	36120	5/5	East
80250356	12" Low Black	026978361288	36128	5/5	East
80250651	6" Grey	026978350602	35060	10/10	East
80250034	6" Black	026978350688	35068	10/10	East
80250753	6" Rust	026978350695	35069	10/10	East
80250713	6" Mint	026978350664	35066	10/10	East
80250038	8" Black	026978350886	35088	10/10	East
80250652	8" Grey	026978350800	35080	10/10	East
80250843	8" White	026978350824	35082	10/10	East
80250714	8" Mint	026978350862	35086	10/10	East
80250653	10" Grey	026978351005	35100	5/5	East
80250755	10" Rust	026978351098	35109	5/5	East
80250715	10" Mint	026978351067	35106	5/5	East
80250042	10" Black	026978351081	35108	5/5	East
80250654	12" Grey	026978351203	35120	5/5	East
80250756	12" Rust	026978351296	35129	5/5	East
80250048	12" Black	026978351289	35128	5/5	East
80250716	12" Mint	026978351265	35126	5/5	East



ArtStone Hanging Bowl

Unique hanging bowl for indoor or outdoor plants. Resin planters made with Artstone a superior blend of stone and resin. Self-watering reservoir conserves water

Item #	Desc	UPC	Vendor	CS/UOS	Location
80250750	10" Rust	026978321091	32109	5/5	East
80250749	10" Black	026978321084	32108	5/5	East
80250809	10" Grey	026978321008	32100	5/5	East
80250839	10" White	026978321022	32102	5/5	East





Countryside Square Tub Planter

Countryside Tubs are designed with classic lines in a variety of shapes and sizes. Each planter features a deep root zone, helping plants stay vibrant and healthy. Drain holes and plugs included.



Item #	Desc	UPC	Vendor	CS/UOS	Location
80250100	14" White	026978261427	26142	10/10	East
80250862	14" Black	026978261489	26148	10/10	East
80250438	14" Brown	026978261434	26143	10/10	East
80250102	18" Terra Cotta	026978261854	26185	10/10	East
80250103	18" White	026978261823	26182	10/10	East



Polypro Plastic Planters & Liners

This polypro plastic flower box planter is made of a superior tough plastic blend with distinctive raised panel design. Sturdy planters for use alone, inside wooden box or inside wire hangers. Lightweight, durable, fade resistant plastic, coded for recycling. Knockout plugs for optional drainage.

Item #	Desc	UPC	Vendor	CS/UOS	Location
80250061	18" Green	026978021816	02181	10/10	East
80250065	18" White	026978021823	02182	10/10	East
80250121	18" Black	026978021885	02188	10/10	East
80250122	24" Black	026978022486	02248	10/10	East
80250062	24" Green	026978022417	02241	10/10	East
80250066	24" White	026978022424	02242	10/10	East
80250123	30" Black	026978023087	02308	10/10	East
80250063	30" Green	026978023018	02301	10/10	East
80250067	30" White	026978023025	02302	10/10	East
80250064	36" Green	026978023612	02361	10/10	East
80250068	36" White	026978023629	02362	10/10	East
80250124	36" Black	026978023681	02368	10/10	East

2025

Classic Urn

The classic urn is the harbinger of modern day flower pots and still to this day, stands tall in heritage. It brings beauty to our plants and surroundings. Two-piece construction with optional punch-out drain holes and UV stable resin.



Item #	Desc	UPC	Vendor	CS/UOS	Location
80250107	14" Black	026978381484	38148	12/12	East
80250120	14" White	026978381422	38142	12/12	East
80250106	14" Stone	026978381460	38146	12/12	East
80250110	19" Black	026978381989	38198	6/6	East
80250108	19" White	026978381927	38192	6/6	East
80250109	19" Stone	026978381965	38196	6/6	East



Plastic Flower Box Tray

This plastic flower box tray is the perfect match for polypro and countryside flower boxes. Protects decks, patios and indoor areas.

Item #	Desc	UPC	Vendor	CS/UOS	Location
80250225	18" Terra Cotta	026978101853	10185	10/10	East
80250224	18" White	026978101822	10182	10/10	East
80250421	18" Sage	026978101808	10180	10/10	East
80250854	18" Black	026978101884	10188	10/10	East
80250423	24" Sage	026978102409	10240	10/10	East
80250229	24" Terra Cotta	026978102454	10245	10/10	East
80250228	24" White	026978102423	10242	10/10	East
80250855	24" Black	026978102485	10248	10/10	East
80250233	30" Terra Cotta	026978103055	10305	10/10	East
80250232	30" White	026978103024	10302	10/10	East
80250856	30" Black	026978103086	10308	10/10	East
80250425	30" Sage	026978103000	10300	10/10	East

Grecian Urn

Novelty's Grecian urns have a neoclassic style, always durable, fashionable and a must-have for deck, patio, pool-side and entry. Two-piece construction with optional punch-out drain holes and UV stable resin.



Item #	Desc	UPC	Vendor	CS/UOS	Location
80250058	12" Black	026978391285	39128	12/12	East
80250023	12" White	026978391223	39122	12/12	East
80250057	12" Stone	026978391261	39126	12/12	East
80250060	18" Black	026978391889	39188	6/6	East
80250024	18" White	026978391827	39182	6/6	East
80250059	18" Stone	026978391865	39186	6/6	East



Countryside Rail Planter

Classic look with deep planting area, drain plugs. Fits 2x4" and 2x6" railings.

Item #	Desc	UPC	Vendor	CS/UOS	Location
80250798	16" White	026978261625	26162	4/4	East
80250863	16" Black	026978261687	26168	4/4	East
80250797	16" Sage	026978261601	26160	4/4	East
80250799	16" Brown	026978261632	26163	4/4	East
80250800	16" Terra Cotta	026978261656	26165	4/4	East
80250801	24" - Sage	026978262400	26240	4/4	East
80250802	24" - White	026978262424	26242	4/4	East
80250803	24" - Brown	026978262431	26243	4/4	East
80250804	24" - Terra Cotta	026978262455	26245	4/4	East

Countryside Flower Box Planter

Choose Countryside Flower Box Planters for a showy display under windows, on porches and decks, and along walkways. Drain holes and plugs included.



Item #	Desc	UPC	Vendor	CS/UOS	Location
80250430	18" Brown	026978161932	16193	10/10	East
80250429	18" Sage	026978161901	16190	10/10	East
80250252	18" Terra Cotta	026978161956	16195	10/10	East
80250251	18" White	026978161925	16192	10/10	East
80250858	18" Black	026978161987	16198	10/10	East
80250432	24" Brown	026978162434	16243	10/10	East
80250431	24" Sage	026978162403	16240	10/10	East
80250256	24" Terra Cotta	026978162458	16245	10/10	East
80250255	24" White	026978162427	16242	10/10	East
80250859	24" Black	026978162489	16248	10/10	East
80250424	24" Brown	026978102430	10243	10/10	East
80250433	30" Sage	026978163004	16300	10/10	East
80250260	30" Terra Cotta	026978163059	16305	10/10	East
80250259	30" White	026978163028	16302	10/10	East
80250434	30" Brown	026978163035	16303	10/10	East
80250264	36" Terra Cotta	026978163653	16365	10/10	East
80250263	36" White	026978163622	16362	10/10	East
80250861	36" Black	026978163684	16368	10/10	East

Flat Bottom Plastic Vase

Honor your loved one's gravesite by adding a bouquet of live or artificial arrangements to a beautiful memorial vase. Each cemetery vase comes with a stake for easy, secure placement. These long-lasting, versatile vases are available in a variety of styles and primarily made in USA with durable, UV-protected, quality plastic. In addition to the placing them at the cemetery, use Memorial Vases in garden beds or gatherings, celebrations, and other social festivities.



Item #	Desc	UPC	Vendor	CS/UOS	Location
80250146	4" x 6.6"	026978051219	05121	36/36	East
80250147	5" x 6.6"	026978051318	05131	36/36	East

Cone Cemetery Vase

These cone cemetery vases are guaranteed leak proof. The stem locks so the vase comes out of the ground with stem.



Item #	Desc	UPC	Vendor	CS/UOS	Location
80250142	4" Plastic	026978050717	5071	36/36	East
80250144	5" Plastic	026978050816	5081	36/36	East
80250141	5" Metal	026978050410	5041	36/36	East

Round Bottom Plastic Vase

Round Bottom plastic cemetery vase has fluted sides, and a rounded bottom. 3"x6.75" with a 3" removable stem.



Item #	Desc	UPC	Vendor	CS/UOS	Location
80250140	3" - White	026978050168	5016	36/36	East
80250139	3" - Green	026978050113	05011	36/36	East

Antique Kettle

Durable, weather-resistant black plastic kettles with hammered finish. Complete with black handle and three balancing legs. Ideal for outdoor patio and entry use. Optional punch-out holes allow for drainage.



Item #	Desc	UPC	Vendor	CS/UOS	Location
80250025	9" Black	026978480983	48098	6/6	East
80250026	12" Black	026978481283	48128	6/6	East
80250027	15" Black	026978481580	48158	6/6	East



EarthBox® Garden Kit

This maintenance-free growing system controls soil conditions, eliminates guesswork, and more than doubles the yield of a conventional garden - with less fertilizer, less water, and virtually no effort. Just add plants, water, and sunlight for an easy garden that requires no digging, no weeding, and no guesswork! Grow tomatoes and other robust vegetables and aromatic herbs in any small space - a balcony, patio, or even rooftops!

Item #	Desc	UPC	Vendor	CS/UOS	Location
80250589	Green	026978801517	80151	4/4	National
80250581	Terra Cotta	026978801050	80105	4/4	National

2025

EarthBox® Junior™ Organic Garden Kit

This compact-sized EarthBox® Junior™ is just like the original EarthBox® gardening system, with the same smart technology, but approximately half the size and specifically designed for smaller spaces. EarthBox® Junior™ is the perfect size for growing a kitchen herb garden and is ideal as a pretty window box with flowers.



Item #	Desc	UPC	Vendor	CS/UOS	Location
80250629	JR Green	026978806512	80651	6/6	National
80250630	JR Terra Cotta	026978806550	80655	6/6	National

EarthBox® Replant Kit

Allows you to re-use your EarthBox® gardening system (not included) year after year. Replaces essential nutrients.



Includes: 1lb 7-7-7 Fertilizer, 1lb Organic Dolomite and two black/white mulch covers

EarthBox® Organic Replant Kit

Includes: 1lb Organic Fertilizer, 1lb Organic Dolomite and two black/white mulch covers

Item #	Desc	UPC	Vendor	CS/UOS	Location
80250607	Replant Kit Standard	026978811004	81100	12/12	National
80250608	Replant Kit Organic	026978811011	81101	12/12	National

Herb Trio Planter With Attached Tray

Suitable for use with any herbs, including basil, rosemary, parsley or chives. Indoor/outdoor use. Weather resistant.



Item #	Desc	UPC	Vendor	CS/UOS	Location
80250790	4" Grey	026978100108	10010	6/6	East
80250791	4" White	026978100122	10012	6/6	East

Earthbox Garden Kit

This set of 12 Earthboxes is sold as a unit. There is nodisplay rack but the set includes 4 each of colors Sage, Dark Green, and TerraCotta for a total of 12 Earthbox kits (planting box,wheels, fertilizers, covers).



Item #	Desc	UPC	Vendor	CS/UOS	Location
80250586	Assorted colors	026978801074	80107.12	12/12	National

EarthBox® Staking System

The EarthBox® gardening system wouldn't be complete without a staking system. The staking system allows tall or vining crops to grow without falling over. Each staking system contains: 5 aluminum tubes, 2 "T" connectors, 2 straight connectors, 2 rim clamps with stainless steel hardware, 2 outrigger feet, 2 casters, 1 trellis net.



Item #	Desc	UPC	Vendor	CS/UOS	Location
80250600	Green	026978810113	81011	4/4	National
80250603	Terra Cotta	026978810151	81015	4/4	National

EarthBox® Root and Veg™ Garden Kit

This gardening system can grow larger and longer root crops such as carrots, rutabagas and parsnips, or just a single tomato plant. Includes: 4 pc. gardening system, 1 lb. Fertilizer and 1 lb. Organic Dolomite.



Item #	Desc	UPC	Vendor	CS/UOS	Location
80250626	Organic Green	026978817518	81751	4/4	National
80250627	Organic Terra cotta	026978817556	81755	4/4	National
80250820	Sage	026978817006	81700	4/4	National



Round Coco Fiber Liners

Formed liner fits inside hanging baskets. Great replacement liner that provides continued use of planters over and over.

Item #	Desc	UPC	Vendor	CS/UOS	Location
80160889	10"	093432841662	84166	24/24	National
80160009	12"	093432885918	88591	24/24	National
80160010	14"	093432885925	88592	24/24	National
80160011	16"	093432885932	88593	12/12	National
80160012	18"	093432885949	88594	12/12	National
80160987	20"	093432878231	87823	6/6	National

Trough Coco Liner

100% Coco fiber liner & adhesive glue components. Excellent water retention, keeps plants saturated & promotes healthy growth.

Item #	Desc	UPC	Vendor	CS/UOS	Location
80160917	24"	093432841693	84169	12/12	National
80160016	30"	093432885987	88598	12/12	National
80160017	36"	093432885994	88599	12/12	National
80160013	48"	093432885956	88595	12/12	National

Half Round Coco Liner

Simply remove all the potting soil and plants from your planter, remove the old liner, replace it with the new liner, and add the soil and plants back to the basket. Extend the life of your wall baskets with this half round coco fiber liner.

Item #	Desc	UPC	Vendor	CS/UOS	Location
80160014	16"	093432885963	88596	12/12	National

Bulk Coco Liner

Bulk coco liner is pre-formed for easy installation. Long lasting coco fibers. Convenient cut to your own size. Keeps moisture in to help plants thrive.

Item #	Desc	UPC	Vendor	CS/UOS	Location
80160189	24"x33'	093432885888	88588	1/1	National
80160190	36"x33'	093432885895	88589	1/1	National

2025

Milkhouse Vintage Planter

Has a vintage white enamel-ware look to it making it suitable for indoor and outdoor living. Animals include a rooster, pig, sheep, horse and cow (2 of each)



Item #	Desc	UPC	Vendor	CS/UOS	Location
80161566	7.5"	093432826157	82615	10/10	National

Half Bucket Galvanized Planter

Vertical wall half bucket rustic planter with wooden handle.



Item #	Desc	UPC	Vendor	CS/UOS	Location
80161085	Silver Aged	093432832202	83220	12/12	National
80161086	Assorted Blue, Yellow, Green, Purple	093432832219	83221	12/12	National

Square Herb Planters

These tin herb planters have retro graphics and a galvanized finish. A folding handle stays upright or folds back for shelf display. Holds four standard 3" plastic herb containers. 2 of each color per case



Item #	Desc	UPC	Vendor	CS/UOS	Location
80161224	10"	093432832554	83255	6/6	National

Lantern Planter w/ Hammered Copper Finish

Upgrade your space with this stylish short lantern planter. Small 13" lantern features a hammered copper finish



Item #	Desc	UPC	Vendor	CS/UOS	Location
80161928	13"	093432821961	82196	6/6	East



Retro Metal Chair Planters

These 19" metal chair planters take rustic & industrial chic garden décor to a fun and whimsical era. Assorted colors.

Item #	Desc	UPC	Vendor	CS/UOS	Location
80161211	19"	093432866252	86625	6/6	National

Farmers Market Oval Planter

This rustic Farmers Market Oval Planter features retro graphics and comes in a trendy aged galvanized finish. It holds three standard 3" plastic herb containers.



Item #	Desc	UPC	Vendor	CS/UOS	Location
80161225	16"	093432832653	83265	6/6	National

Galvanized Steel Oval Planters

These planters feature a trendy aged galvanized finish with convenient handles for carrying.



Item #	Desc	UPC	Vendor	CS/UOS	Location
80161227	10"	093432832516	83251	6/6	National
80161228	16"	093432832523	83252	6/6	National

Washtub Planter

Round washtub planter. Features steel construction with galvanized finish. Includes 2 sturdy handles for easy handling.



Item #	Desc	UPC	Vendor	CS/UOS	Location
80161226	8"	93432832509	83250	6/6	National

Woven Wire Herb Basket Planter

100% steel herb basket. Burlap liner included. Holds three standard three inch plastic herb containers.



Item #	Desc	UPC	Vendor	CS/UOS	Location
80161221	14"	093432832721	83272	6/6	National

Rustic Woven Wire Baskets

Rustic Farmhouse outdoor basket with rust finish speaks to the highly popular rustic trend; long-lasting burlap liner included. These planters are designed for both high volume growers, as well as garden center retailers.



Item #	Desc	UPC	Vendor	CS/UOS	Location
80160919	14"	093432842706	84270-6	6/6	National

Round Hanging Planter

Sturdy round metal plant hanger withstands the elements while providing secure support. Holds an 8" pot



Item #	Desc	UPC	Vendor	CS/UOS	Location
80161994	17" circle	093432810170	81017	6/6	National

Washtub Planter w/ Copper Handles

Modern Farmhouse designs are on-trend, classic looking garden accessories to decorate outdoor living spaces. Decorate your table with this smart, matte black bucket planter. The sturdy riveted copper plated handles add modern appeal and make it easy to move the piece.



Item #	Desc	UPC	Vendor	CS/UOS	Location
80161905	14"	093432814284	81428	6/6	National



Coco Pole

This coconut fiber pole for plants is ideal for indoor climbing plants. Offers support while maintaining moisture for aerial roots absorption. Additional poles can be stacked on top of each other to accommodate the new height.



Item #	Desc	Vendor	CS/UOS	Location
81621714	24"	CP24	48/48	East



Rope & Fern Hanging Basket (A)

Naturally beautiful and functional. Poly liner minimizes water leakage. Powder coated steel for added rust resistance.

Item #	Desc	UPC	Vendor	CS/UOS	Location
80160196	12" Cone	093432886366	88636	10/10	National

Growers Hanging Baskets (B)

Growers series hanging basket. Use multiple baskets and plants hung at different levels to create your own unique decorative effect. The durable, weather resistant finish of this planter will maintain its attractive dark green color and quality season after season. Includes coco fiber liner.

Item #	Desc	UPC	Vendor	CS/UOS	Location
80160006	12" Green	093432885000	88500	12/12	National
80160007	14" White	093432885048	88504	12/12	National

Black Rattan Hanging Basket (C)

Knots and curves on the twig construction add a rustic look to the basket, for a truly individual item. A metal framework helps hold the shape, and a plastic liner inside the basket keeps it water tight.

Item #	Desc	UPC	Vendor	CS/UOS	Location
80160199	12"	093432886403	88640	10/10	National
80160200	14"	093432886410	88641	10/10	National

Rustic Hanging Grower Basket (D)

This 12" hanging basket includes burlap liner and easy-clip on wire painted hanger. Constructed of fashionable rust-finish chicken wire with burlap liners, these planters are designed for both high volume growers, as well as garden center retailers. Includes burlap liner and easy clip-on wire painted hanger.

Item #	Desc	UPC	Vendor	CS/UOS	Location
80160925	12"	093432842805	84280	25/25	National



Coco Critter Planters

Made from genuine coco fiber woven onto a steel frame, these adorable critters make perfect rustic planters, fully lined for safe indoor use. Fits 4 inch plants for drop ins!

Item #	Desc	Vendor	CS/UOS	Location
81621701	Cow 11.4"x5.1"x6.3"	69063	12/12	East
81621699	Pig 11"x5.1"x6.3"	69062	12/12	East
81621702	Elephant 11.4"x7"x6.7"	69059	12/12	East
81621703	Cat 11"x6.3"x9"	69071	12/12	East
81621700	Bear 12.6"x5.1"x9.4"	69057	12/12	East

SUCCULENTS ARE BIG BUSINESS

They're quick to turn with minimal cost, and their niche status commands premium prices. Griffin represents 20+ succulent producers with quality plants in product forms to meet your needs. Contact your Griffin sales representative or log on to griffins.com to get started!





Macramé Plant Hangers (A)

Simple, sleek version of macramé plant hanger. UV coated so that it can be used both indoors and out. This plant hanger has an authentic hand-made look about it that's sure to add a nostalgic touch to your home. All you have to do is choose your favorite potter plant to go inside. Assorted cases include 3 each of Jute/tan, Brown, Black, Rust, Sage, Forest Green, Navy and White.

Item #	Desc	UPC	Vendor	CS/UOS	Location
80780042	30" Jute	855354002084	2084	12/12	National
80780048	30" Asst.	855354002169	2169	24/24	National
80780051	36" Jute	855354002091	2091	12/12	National
80780057	36" Asst.	855354002176	2176	24/24	National
80780210	36" Neutral	855354002374	2374	20/20	National

All Natural Plant Hanger (B)

Can be used both indoor and outdoor. Holds a variety of sizes of planters weighing up to 20LB.

Item #	Desc	UPC	Vendor	CS/UOS	Location
80780145	36"	855254002855	2855	12/12	National

All Natural Knotted Rope Hanger (C)

Perfect to hold glassware, bowls, candle holders, etc.

Item #	Desc	UPC	Vendor	CS/UOS	Location
80780171	30"	894120001425	1425	12/12	National
80780172	36"	894120001432	1432	12/12	National

Mini Hangers (D)

Item #	Desc	UPC	Vendor	CS/UOS	Location
80780188	18" Twine	894120001654	1654	12/12	National
80780209	18" Macrame	855354002398	2398	12/12	National
80780219	18" Cotton	850007839185	9185	12/12	National



Beaded Cotton Hanger

Item #	Desc	UPC	Vendor	CS/UOS	Location
80780225	42"	850007839062	9062	6/6	National



Wooden Shelf Hanger

This gorgeous 12" pecan wooden table can be used as a night stand or coffee table. 36" hanger made of woven cotton.

Item #	Desc	UPC	Vendor	CS/UOS	Location
80780260	36"	850007839307	9307	5/5	National



Wall Planter

Decorative macramé wall hanger in Antique White, designed to perfectly hold a variety of sizes of pots.

Item #	Desc	UPC	Vendor	CS/UOS	Location
80780200	Large	855354002060	2060	6/6	National
80780201	Small	855354002077	2077	6/6	National



Wall Planter

Item #	Desc	UPC	Vendor	CS/UOS	Location
80780269	Small V Design	850007839420	9420	6/6	National
80780267	Small Diamond Design	850007839406	9406	6/6	National
80780268	Large V Design	850007839413	9413	6/6	National

PLANT HANGERS



Tassel Woven Plant Hanger (A)

Item #	Desc	UPC	Vendor	CS/UOS	Location
80780256	42" No Tassel	850007839529	9529	6/6	National

Brown Beaded Cotton Woven Hanger (B)

Item #	Desc	UPC	Vendor	CS/UOS	Location
80780254	42" Brown Beaded	850007839352	9352	6/6	National

Woven Plant Pouch (C)

Item #	Desc	UPC	Vendor	CS/UOS	Location
80780324	Small Plant Pouch	850007839741	9741	6/6	East
80780325	Large Plant Pouch	850007839888	9888	6/6	National

Woven Twisted Cord Hanger (D)

Item #	Desc	UPC	Vendor	CS/UOS	Location
80780223	42" Twisted Cord	850007839055	9055	6/6	National

Mini Woven ZigZag Hanger (E)

Item #	Desc	UPC	Vendor	CS/UOS	Location
80780250	17" Mini ZigZag	850007839345	9345	12/12	National

Square Table Hanger (F)

Item #	Desc	UPC	Vendor	CS/UOS	Location
80780364	9" Table	850052957179	7179	6/6	National

Woven Plain Cord Hanger (G)

Item #	Desc	UPC	Vendor	CS/UOS	Location
80780224	42" Plain Cord	850007839079	9079	6/6	East

2-Tier Woven Hanger (H)

Item #	Desc	UPC	Vendor	CS/UOS	Location
80780222	60" 2-Tier	850007839123	9123	6/6	East

2-Tier Hanging Utility Basket (I)

Item #	Desc	UPC	Vendor	CS/UOS	Location
80780328	Double Tier	850007839819	9819	6/6	East

Hanger Plant Hooks

White ceiling hanger hooks. Each retail ready pack contains three pieces.



Item #	Desc	UPC	Vendor	CS/UOS	Location
80780244	3 Pack	894120001852	1852	12/12	East

Hanger Plant S-Hooks

S-hooks - 3 pieces per retail ready package



Item #	Desc	UPC	Vendor	CS/UOS	Location
80780245	3 Pack	894120001869	1869	12/12	East



Mini Green Jute Hanger



Item #	Desc	UPC	Vendor	CS/UOS	Location
80780213	18"	894120001845	1845	12/12	National

Hang Planter

A stylish woven cotton planter in off-white. Customers can add their favorite plant to this popular planter.



Item #	Desc	UPC	Vendor	CS/UOS	Location
80780357	Off White	850052957087	7087	6/6	East

Macrame Plant Hammock Assorted



Item #	Desc	UPC	Vendor	CS/UOS	Location
80780258	48"	850007839260	9260	10/10	National

Beaded Plant Hanger

This gorgeous new Beaded Plant Hanger Nest holds up to a 6in pot. Includes decorative beads and a wooden O-Ring at the top.



Item #	Desc	UPC	Vendor	CS/UOS	Location
80780347	40"	850007839918	9918	6/6	East

Macrame USA Flag

A bohemian yet patriotic wall display of the American flag in woven macrame details. Complements well with coordinating designs for an artisanal home decor collection.



Item #	Desc	UPC	Vendor	CS/UOS	Location
80780345	17" x 22"	850007839703	9703	6/6	National



A



B



Item #	Desc	UPC	Vendor	CS/UOS	Location
80780182	A Terra Cotta Mini Pot W/ Hanger	894120001456	1456	12/12	National
80780181	B Terrarium W/ Hanger	894120001449	1449	12/12	National

Best Buds Boxed Pot W/ Hanger

Cannabis themed hanging planter.



Item #	Desc	UPC	Vendor	CS/UOS	Location
80780283	Lucy	850007839598	9598	12/12	National
80780282	Bud	850007839581	9581	12/12	National



Mini Hanger

Woven Cotton Plant Hanger / Car Accessories / Rear View Mirror Charm / Cute Hanging Rearview Car Decor Boho Hanger. Pop in your favorite mini succulent. (plant is not included in this)



Item #	Desc	UPC	Vendor	CS/UOS	Location
80780354	Mini Car Hanger	850052957056	7056	12/12	East



Assorted Plant Hangers

Item #	Desc	UPC	Vendor	CS/UOS	Location
80780211	A 30" Neutral Macramé	855354002381	2381	20/20	National
80780246	18" Jute Colored	894120001883	1883	12/12	East
80780177	B 36" Jute Colored	894120001524	1524	24/24	National
80780221	C 18" Mini Cotton	850007839208	9208	28/28	National
80780033	D 30" Neutral Fabric	855354002206	2206	24/24	National



Flex Garden & Storage Set

Built-in drip tray. Sturdy construction good for herbs vegetables and flower great for small spaces adjust to any area each planter is 20" x 13" x 12". Kit includes 3 planters and 2 legs.



Item #	Desc	UPC	Vendor	CS/UOS	Location
81250843	Grey	684143081319	HDR-081319	8/8	East



Bushel Basket

Item #	Desc	Vendor	CS/UOS	Location
81250851	8" Brown w/ Tan Wash	CF-078814	12/12	East
81250852	8" Tan w/ Brown Wash	CF-078821	12/12	East
81250756	8" Tan w/ Brown Wash	CF-078821	1000/1000	East
81250755	8" Tan w/ Brown Wash	CF-078814	1000/1000	East
81250853	13" Brown w/ Tan Wash	CF-078838	12/12	East
81250758	13" Tan w/ Brown Wash	CF-078845	500/500	East
81250854	13" Tan w/ Brown Wash	CF-079378	12/12	East
81250757	13" Tan w/ Brown Wash	CF-078838	500/500	East



Westlake Rustic Galvanized Planters

Item #	Desc	UPC	Vendor	CS/UOS	Location
81250363	12" Hanging Basket	684143054801	HDR-054801	12/12	East
81250364	24" Deck Rail	684143054818	HDR-054818	3/3	East
81250277	16" Square	684143046851	HDR-046851	4/4	East
81250362	15" Round	684143054795	HDR-054795	8/8	East
81250683	10" Round	684143064787	HDR-064787	12/12	East
81250841	79pc Mix	684143064053	HDR-064053G	1/1	East

SOUTHERN PATIO

Vado Planter

This planter is easy to clean with its sleek, glossy finish. A plastic composite construction provides a lightweight planter that is easy to move and durable.



Item #	Desc	UPC	Vendor	CS/UOS	Location
81250892	8" Sea Blue	684143086130	CRM-086130	2/2	East

Oakland Planter

The Oakland planter is a modern rendition on the classic farmhouse crock-style planter. It can compliment both traditional and modern decorating preferences with its subtle blue tone and shape.



Item #	Desc	UPC	Vendor	CS/UOS	Location
81250874	8" Blue	684143085959	CRM-085959	2/2	East

Jasper Planter

This line of authentic ceramic planters is heavy duty and one of a kind. Features an attached saucer making it ideal for indoor gardening. Teal finish with durable ceramic construction.



Item #	Desc	UPC	Vendor	CS/UOS	Location
81250878	6" Teal	684143085997	CRM-085997	4/4	East

French Rustic Planter

Create an escape to a countryside chateau with the French Rustic Planter. The intricate dark rust colored pattern against a milky white glaze helps create a cozy ambience. Made from traditional ceramic, this planter provides superior quality.



Item #	Desc	UPC	Vendor	CS/UOS	Location
81250881	6" White	684143086024	CRM-086024	4/4	East
81250882	8" White	684143086031	CRM-086031	2/2	East

Emma Round Planter

The Emma planter is the right touch of elegance for any room decorated in a traditional style. The detailed pattern intricately sweeps throughout the planter against a dark gray background with highlights of black perfectly blended to create the right accent piece.



Item #	Desc	UPC	Vendor	CS/UOS	Location
81250893	6" Gray	684143086147	CRM-086147	4/4	East

Annandale Planter

The Annandale planter offers a touch of fun and elegance with a classic bell-shaped design and a detailed eye-catching pattern. The celadon green glaze is subtle yet provides a light pop of color to brighten up any room.



Item #	Desc	UPC	Vendor	CS/UOS	Location
81250889	6" Celadon	684143086109	CRM-086109	4/4	East
81250890	8" Celadon	684143086116	CRM-086116	2/2	East

Ava Planter

Ceramic planters combine opulent appearance of their traditional ceramic or stone planter counterparts with affordability and durability. Handmade clay pottery offers an authentic and unique planter for your garden.



Item #	Desc	UPC	Vendor	CS/UOS	Location
81250875	6" Brown	684143085966	CRM-085966	4/4	East
81250876	8" Brown	684143085973	CRM-085973	2/2	East
81250877	12" Brown	684143085980	CRM-085980	1/1	East

Ana Planter

Handmade clay pottery offers an authentic and unique planter for your garden. Gloss finish and styling provide an elegant appearance. Protective rubber pads to prevent scratching.



Item #	Desc	UPC	Vendor	CS/UOS	Location
81250693	6"	684143064817	CRM-064817	4/4	East
81250694	8"	684143064824	CRM-064824	2/2	East
81250695	12"	684143064831	CRM-064831	1/1	East

Copper & Silver Barnett Pallet

These attractive poly resin planters are great for any deck or indoor planting 15" Planters 54 Piece Mix Pallet



Item #	Desc	Vendor	CS/UOS	Location
81250923	54 pieces (27 Copper / 27 Silver)	HDR-094562G	1/1	East

Gloss Planter



*Resin

Item #	Desc	Vendor	CS/UOS	Location
81250868	16" Chocolate Cloud	HDR-087120	8/8	East
81250869	18" Chocolate Cloud	HDR-087199	6/6	East

Anthony Planter

12" Matte white ceramic pot with cork bottom.



Item #	Desc	Vendor	CS/UOS	Location
81250866	12"	HDR-087793	12/12	East

Reactive Red & Navy Mixed Pallet

Assorted sizes, made of resin plastic.
 (9each) 12" Navy / 12" Red
 (7each) 18" Navy / 18" Red



Item #	Desc	UPC	Vendor	CS/UOS	Location
81250920	32 pieces	40684143094576	HDR-094579G	1/1	East

Alice Planter

The elegant Alice ceramic pot features a glossy light brown finish with a dark base. A built-in drainage hole prevents over-watering and an attached saucer protects surfaces.



Item #	Desc	UPC	Vendor	CS/UOS	Location
81250687	6"	684143064794	CRM-064794	4/4	East
81250688	8"	684143064800	CRM-064800	2/2	East

Brentwood Planter

The Brentwood square ceramic pot features a white finish with a floral design that can accent any gardening space. A built-in drainage hole prevents over-watering and an attached saucer protects surfaces.



Item #	Desc	UPC	Vendor	CS/UOS	Location
81250689	6"	684143064879	CRM-064879	4/4	East
81250690	8"	684143064886	CRM-064886	2/2	East

12" Tampa Hanging Basket

12" Plastic resin hanging basket planters. Comes with hanger and cap dish.



Item #	Desc	Vendor	CS/UOS	Location
81250917	Eggnog	HDR-086574	12/12	East
81250918	Gray Flannel	HDR-086581	12/12	East
81250919	Caribou	HDR-086598	12/12	East



15" Tampa Urn

Item #	Desc	Vendor	CS/UOS	Location
81250863	Eggnog	HDR-086642	6/6	East
81250864	Grey Flannel	HDR-086659	6/6	East
81250865	Caribou	HDR-086666	6/6	East

Collins Planter

This planter is easy to clean with its sleek, glossy finish. A plastic composite construction provides a lightweight planter that is easy to move and durable.



Item #	Desc	UPC	Vendor	CS/UOS	Location
81250886	6" Blue	684143086079	CRM-086079	4/4	East
81250883	6" Oxblood	684143086048	CRM-086048	4/4	East
81250884	8" Oxblood	684143086055	CRM-086055	2/2	East

2025



*Made of HDR Plastic



Jocelyn Pallet (A)

Item #	Desc	UPC	Vendor	CS/UOS	Location
81250870	48pc	684143086413	CRM-086413G	1/1	East

Panarea & Vivara Pallet (B)

Item #	Desc	UPC	Vendor	CS/UOS	Location
81250924	24pc	40684143091835	CRM-091837G	1/1	East

Beehive Pallet (C)

18" Plastic Planters with Attached saucers. 8 of each color, Red splatter, Navy, White, and Gray

Item #	Desc	UPC	Vendor	CS/UOS	Location
81250682	32pc assortment (4 colors)	684143064107	HDR-064107G	1/1	East

Jori Pallet (D)

Item #	Desc	UPC	Vendor	CS/UOS	Location
81250698	32pc	684143064299	CRM-064299G	1/1	East

Cathedral Pallet (E)

Item #	Desc	UPC	Vendor	CS/UOS	Location
81250700	27pc	684143064398	CRM-064398G	1/1	East

Natalie & Baku Pallet (F)

Item #	Desc	UPC	Vendor	CS/UOS	Location
81250846	27pc	684143078388	CRM-078388G	1/1	East



Heritage 12" & 16" Mixed Pallet

620 pieces | 12" - 320 | 16" - 300

Item #	Desc	UPC	Vendor	CS/UOS	Location
81250922	620 pieces	40684143094613	HDR-094616G	1/1	East



12" Kay Planter

Item #	Desc	UPC	Vendor	CS/UOS	Location
81250567	3 gal Blue	684143068440	CF-068440	12/12	East
81250569	3 gal White	684143068464	CF-068464	12/12	East
81250570	3 gal Red	684143068471	CF-068471	12/12	East

Barndoor 15" Square Mixed Pallet

108 pieces
(54) Brown Barn Door
(54) Gray Barn Door



Item #	Desc	UPC	Vendor	CS/UOS	Location
81250921	15"	40684143094607	HDR-094609G	1/1	East

Whiskey Barrel Planters

Features a 3-band whiskey barrel design. This resin planter has UV protectors to resist fading and cracking. Material has more endurance than wood.



Item #	Desc	UPC	Vendor	CS/UOS	Location
81250432	Mix Pallet 57 pieces	40684143055509	HDR-055501G	1/1	East



Pinot Barrels Planters

The Pinot Barrels are available in wood-look finishes of Natural Oak, Weathered Teak, and Kentucky Walnut.

Item #	Desc	UPC	Vendor	CS/UOS	Location
81250958	15.5" Oak	684143101994	10000-03313	12/12	East
81250960	15.5" Walnut	684143102014	10000-03315	12/12	East
81250959	15.5" Teak	684143102007	10000-03314	12/12	East
81250961	22.25" Oak	684143102021	10000-03316	8/8	East
81250963	22.25" Walnut	684143102045	10000-03318	8/8	East
81250962	22.25" Teak	684143102038	10000-03317	8/8	East

HDR® Wine Barrel

With a down-home, country-style feel, our HDR® wine barrel creates the perfect combination of elegance and simplicity to your outdoor or indoor living space. UV protectors increase resistance to cracking and fading. Your vibrant colored flower or vegetable arrangements will provide a pleasing pop of color in these dark, faux-wood planters.



Item #	Desc	UPC	Vendor	CS/UOS	Location
81250005	15" KY Walnut	684143007227	HDR-007227	10/10	East

Whiskey Basket Planter



Item #	Desc	Vendor	CS/UOS	Location
81250752	22" Basswood	CF-070245	6/6	East

Utopian Urn

The utopia urn is a long time classic. It's height and fluted lines on the side give it a regal appearance and it is perfect for fuller plants and shrubs. The poly-resin construction of the dynamic design planter series provides a sturdy product that is light weight and UV protected.



Item #	Desc	UPC	Vendor	CS/UOS	Location
81250133	14" Black	038776003079	UU1412BK	12/12	East
81250135	19" Black	038776002072	UU1906BK	6/6	East
81250136	19" Stone	038776002133	UU1906ST	6/6	East

Grecian Urn

Resin based urn is lighter weight and more durable than traditional materials. UV coated finish provides a weather resistant, long-resistant, long lasting color.



Item #	Desc	UPC	Vendor	CS/UOS	Location
81250130	18" Black	049206030602	UR1810BK	10/10	East

River Rock Planter

15" Plastic resin planter.



Item #	Desc	UPC	Vendor	CS/UOS	Location
81250867	15"Grey	684143086680	HDR-086680	4/4	East

Standard Clay Pot & Saucer



Item #	Desc	UPC	Vendor	CS/UOS	Location
81250703	10" Pot	684143043259	TC1006SPT	6/6	East
81250716	6" Saucer	684143055358	TC0612SRT	12/12	East

Lacis Trellis Planter

Utilized cutting edge techniques to produce a resin planter of superior quality with precise coloration, texture and finish. Crafted from durable high-density resins



Item #	Desc	UPC	Vendor	CS/UOS	Location
81250375	15" Round Trellis	684143054863	HDR-054863	12/12	East
81250373	15" Round	684143054849	HDR-054849	6/6	East
81250374	16" Square	684143054856	HDR-054856	6/6	East

2025

Quilted Bell Planter

13" Plastic resin quilted bell



Item #	Desc	UPC	Vendor	CS/UOS	Location
81250280	13"	684143046813	CF-046813	6/6	East

Plantable Birdhouse

The SuperMoss Amber Plantable Birdhouse is a cute way to plant everything from succulents to mosses to grasses. It has a small container on top with a plastic liner to keep the soil and water out of the birdhouse. Includes a mixed set of 3 Amber Plantable Birdhouses.



Item #	Desc	UPC	Vendor	CS/UOS	Location
80231353	3 Color Set	759834568001	56800	2/2	National



Cone Hanging Basket

Item #	Desc	UPC	Vendor	CS/UOS	Location
80230811	12" Diamond Hill	759834296683	29668	8/8	National
80230807	12" Mammoth	759834296607	29660	8/8	National
80230696	12" Wintergreen	759834296669	29666	8/8	National



Wood Woven 14" Pyramid Basket



Item #	Desc	UPC	Vendor	CS/UOS	Location
80230805	June	759834296317	29631	8/8	National
80230804	Stratton	759834296300	29630	8/8	National

Vineyard Basket Set

Small - 4¾" x 4¼"
Medium - 5½" x 4¾"
Large - 6¾" x 5"



Item #	Desc	UPC	Vendor	CS/UOS	Location
80230104	Set of 3	759834551508	55150	6/6	National

Woodbury Round 14" Hanging Basket



Item #	Desc	UPC	Vendor	CS/UOS	Location
80230815	14"	759834297048	29704	8/8	National

Ventura Deco Basket Set

Small - 4.7" x 4.7" x 3.9"
Medium - 5.1" x 5.1" x 4.3"
Large - 5.9" x 5.9" x 4.3"
XLarge - 7¼" x 7¼" x 4¾"



Item #	Desc	UPC	Vendor	CS/UOS	Location
80230100	Set of 4	759834550709	55070	6/6	National



Deco Basket Vista Round

Unique moss covered basket with a protective liner. Vista style features a tall handle. Small 4.5"x5.5"x8" | Medium 6.7"x3.2"x9.5" Large 8.3"x3.7"x11"

Item #	Desc	UPC	Vendor	CS/UOS	Location
80230107	Set of 3	759834555902	55590	6/6	National



Deco Basket Arroyo

Made from the same high-quality green Mountain Moss as the rest of our creative line. Arroyo style features a larger handle. Small 9.9"x4.1"x12.6" | Medium 11.2"x4.7"x13.8" | Large 12.6"x5.5"x15"

Item #	Desc	UPC	Vendor	CS/UOS	Location
80230059	Set of 3	759834555209	55520	6/6	National



Miramonte Basket Set

Deco round handle basket that's longer lasting, has a vibrant color, is cleaner to use and is more pliable. Comes in pack of 3. Set of 3 - Small (5" Diam x 2.5" Deep x 8.25" H with Handle), Medium (6.75" Diam x 3" Deep x 9.5" H with Handle), Large (8.25" Diam x 3.75" Deep x 11" H with Handle).

Item #	Desc	UPC	Vendor	CS/UOS	Location
80230080	Set of 3	759834555100	55510	6/6	National

Beaumont Deco Purse Set

Wicker handles,
Small - 8" x 3½" x 5½"
Medium - 10" x 3½" x 5¾"
Large - 12" x 4" x 6"



Item #	Desc	UPC	Vendor	CS/UOS	Location
80230067	Set of 3	759834555049	55504	6/6	National

Beaumont Deco Baskets

Small: 7.9" x 3.7" x 5.1"
Medium: 5.91" x 5.914" x 4.33"
Set of Three:
Small - 7" x 3¾" x 9¾"
Medium - 8½" x 3" x 5"
Large - 10½" x 3¾" x 9¾"



Item #	Desc	UPC	Vendor	CS/UOS	Location
80230066	Small	759834555018	55501	12/12	National
80230064	Medium	759834555025	55502	12/12	National
80230020	Set of 3	759834555001	55500	6/6	National



Beaumont Lavender Purse

Lavender - Set of 3 / Small (7.9" L x 3.7" W x 5.1" H), Medium (8.5" L x 3" W x 5" H), Large (10.5" L x 3.75" W x 9.75" H). Unique fresh green colored moss covered basket with a protective liner. Recommended for indoor use as well as for covered outdoor environments such as patios and porches.

Item #	Desc	UPC	Vendor	CS/UOS	Location
80230627	Set of 3	759834557005	55700	6/6	National

Deco Purse Wicker Side

Small (7.9in L x 3.7in W x 5.1in H)
Medium (8.5in L x 3in W x 5in H)
Large (10.5in L x 3.75in W x 9.75in H)



Item #	Desc	UPC	Vendor	CS/UOS	Location
80230021	Set of 3	759834555056	55505	6/6	National



Ball Planter

12" x 12" x 12" x 20" Black metal chain included

Item #	Desc	UPC	Vendor	CS/UOS	Location
80230364	12"	759834293422	29342	4/4	National



Coffee Cup Deco Baskets

Deco Collection: 4" & 6" decorative coffee cups.

Item #	Desc	UPC	Vendor	CS/UOS	Location
80230123	4"	759834552543	55254	12/12	National
80230124	6"	759834552567	55256	12/12	National



Watering Can

Rustic Deco collection

Item #	Desc	UPC	Vendor	CS/UOS	Location
80230429	5" Small	759834552598	55259	12/12	National
80230141	7" Medium	759834552604	55260	12/12	National
80230430	9" Large	759834552611	55261	12/12	National



Paula Pumps

Deco Moss shoe basket
10" x 5½"

Item #	Desc	UPC	Vendor	CS/UOS	Location
80230022	Pumps	759834555732	55573	12/12	National

Plantable Birdhouse Gazebo

Woven Birdhouses are made the same way as our MossWeave Baskets, and are extremely durable and meant for outdoor and garden use. The nests maintain their shape through the elements and will not deteriorate for multiple years. Each house comes with an elegant chain to easily hang from a tree branch or hook.



Item #	Desc	UPC	Vendor	CS/UOS	Location
80230936	Plantable House	759834567011	56701	6/6	National



Shasta Deco Basket

9.9" x 6.3" x 4.3"

Item #	Desc	UPC	Vendor	CS/UOS	Location
80230094	Shasta Basket	759834550235	55023	12/12	National



Peace Sign Planter

Express yourself with our Modern Planters. A clean matte white finish complements a variety of 2" drop in plants.

Item #	Desc	UPC	Vendor	CS/UOS	Location
81510404	Peace	038858606433	7450-04-222	4/4	National



Hang Loose Planter

Express yourself with our Modern Planters. A clean matte white finish complements a variety of 2" drop in plants.

Item #	Desc	UPC	Vendor	CS/UOS	Location
81510405	Hang Loose	038858606457	7451-04-222	4/4	West

4 Pc. Terrarium Tool Kit

Includes rake, shovel, brush and tweezers. Wooden handles and metal tips. Use when making a terrarium.

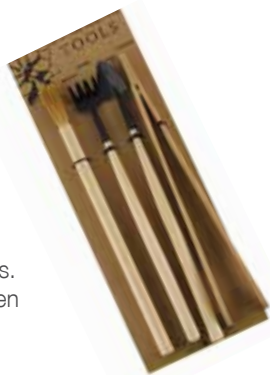

Item #	Desc	UPC	Vendor	CS/UOS	Location
81510045	4pc	38858069368	9680-12-00	12/12	National

Pebble Planter



Item #	Desc	UPC	Vendor	CS/UOS	Location
81510359	4.5"	038858120069	750-06-437	6/6	East

Never Dry Plant Pal Singles

Soaking device helps water your plants. Clay base releases water when soil needs it. Waters your plants by diffusion. Best used with a long neck bottle.



Item #	Desc	UPC	Vendor	CS/UOS	Location
81510056	Plant Pal	038858077929	6715-24-00	24/24	National

Olivia Bowl



Item #	Desc	UPC	Vendor	CS/UOS	Location
81510323	6"	038858050106	3361-06-09	6/6	West
81510322	9 3/4" x 4 3/4"	038858050090	3360-06-09	6/6	National

Terrarium Cloche

Fun, modernized take on terrariums. Built-in holes on cloche limit fogginess. Remove cloche to water accordingly.



Item #	Desc	UPC	Vendor	CS/UOS	Location
81510017	7" x 8.25"	038858067708	3776-04-09	4/4	National
81510018	10" x 11.38"	038858067715	3777-04-09	4/4	West

Stoneware Tapered Pot



Item #	Desc	UPC	Vendor	CS/UOS	Location
81510455	2" Charcoal	038858619730	7943-24-1235	24/24	National
81510456	4" Charcoal	038858619754	7944-06-1235	24/24	East
81510450	4" White	038858619631	7944-06-22	24/24	East
81510451	4.5" White	038858619655	7945-06-22	6/6	National
81510457	4.5" Charcoal	038858619778	7945-06-1235	6/6	National



Stoneware Trio Assortment

Show off three of your favorite succulents or small plants in this modern tapered trio assortment planter. Each planter has a glazed interior and a drainage hole and all three planters fit nicely in a drainage tray. 14.1X4.1/2w X 3.3/4h 3" opening

Item #	Desc	UPC	Vendor	CS/UOS	Location
81510454	Trio Tray	038858619716	7948-02-22	2/2	East

Propagation Kit w/ Wood Base

Propagate plant cuttings with a stylish four tube kit. Tubes sit within a wooden base and provide plenty of space for expansive root development in cuttings. Use with rooting hormone to encourage quick root growth. Plants sold separately.



Item #	Desc	UPC	Vendor	CS/UOS	Location
81510461	6"	038858619877	3094-06-920	6/6	West

Farmhouse Essential Vase

The 4in Essential Vessel is a modern cylinder shape in a farm fresh neutral. The matte clay body is complemented by a satin glaze finish.



Item #	Desc	UPC	Vendor	CS/UOS	Location
81510410	4" White	038858098177	9331-06-1184	6/6	East

Round Hanging Terrarium

These sleek, sculptural vessels make a contemporary statement at any special event. Suspend in multiples to add drama. Plant with micro-greens, small succulents, or air plants. Pair with our Terrarium Tool Kit to create the perfect design!



Item #	Desc	UPC	Vendor	CS/UOS	Location
81510006	7"	038858056511	3753-06-09	6/6	West

Vase w/ Light

Your plants will thrive in this modern glass terrarium vase! The bamboo lid has a built-in battery-operated LED light to keep your plants thriving and shining bright.



Item #	Desc	UPC	Vendor	CS/UOS	Location
81510748	6"	038858639677	5416-06-9194	6/6	West

Bubble Ball

The 8" glass Bubble Ball Vase will add a unique touch to any room. Use as a terrarium or fill with water and let your petals float. The seamless design delivers both excellent quality and an elegant look.



Item #	Desc	UPC	Vendor	CS/UOS	Location
81510028	8"	038858020970	5408-06-09	6/6	West
81510747	8" Lid w/ Light	038858639653	5415-04-9194	4/4	West

Pyramid Vase

Strong, durable glass makes for light weight transporting. The Gathering vase is perfect for a dozen stems or candles- truly a multi-use vase. Crafted from recycled materials. 4" opening.



Item #	Desc	UPC	Vendor	CS/UOS	Location
81510131	7 3/8"	038858547095	4123-09-09U	9/9	West

Artisan Terrarium

A planter with presence, this Artisan Terrarium has a large, fluid like shape that adds an artistic touch to the typical terrarium. The wide-mouth opening provides plenty of room to arrange and maintain custom creations.



Item #	Desc	UPC	Vendor	CS/UOS	Location
81510137	14"	038858135674	3550-02-09	2/2	West

Rosie Posie Bulb Planter

6" glass rosie posie bulb planter, opening is 3.5."



Item #	Desc	UPC	Vendor	CS/UOS	Location
81510751	6"	038858639615	3043-06-9193	6/6	West

Bubble Ball Bulb Planter

8" glass bubble ball bulb planter, opening is 3.5."



Item #	Desc	UPC	Vendor	CS/UOS	Location
81510752	8"	038858639592	5413-04-9193	4/4	West

Cylinder Bulb Planter

9.5" glass cylinder bulb planter, opening is 3.5."



Item #	Desc	UPC	Vendor	CS/UOS	Location
81510750	9.5"	038858639578	3042-06-9193	6/6	West

Wooden Trellis Planter

Characterized by the distinct natural markings of the Acacia wood construction, the trellis will age to a golden brown due the natural oil applied & will withstand the elements for many years of service.



Item #	Desc	UPC	Vendor	CS/UOS	Location
81510683	7"	810028671416	AWP520140KD	1/1	West
81510684	24"	815899022756	AWP520460	1/1	West

Mini Hanging Animals

3" Mini Hanging Animals. Hang on the side of your favorite planter! Assorted PDQ displays easily on shelves or counter tops. Ceramic turtle, frog and hedgehog.



Item #	Desc	UPC	Vendor	CS/UOS	Location
81510430	Hanging Asst Animals	038858606662	7898-12-1315	12/12	National



Mini Terracotta Animal Planters

Assorted PDQ displays easily on shelves or counter tops. Terracotta llama, turtle, elephant and hedgehog. Height range: 2½"-3" (elephant & llama heads up to 6"). Opening: 2"-2½".

Item #	Desc	UPC	Vendor	CS/UOS	Location
81510428	Terracotta Asst Planters	038858606624	7896-12-1295	12/12	National



Mini Ceramic Animal Planters

Assorted PDQ displays easily on shelves or counter tops. Ceramic llama, turtle, elephant and hedgehog. Height range: 2½"-3½". Opening: 2"-2½".

Item #	Desc	UPC	Vendor	CS/UOS	Location
81510429	Ceramic Asst Planters	038858606648	7897-12-1305	12/12	National

Founded in 2007 Tusco Products is a leading manufacturer of rotational molded planters and accessories both traditional and modern styling. We offer our customers light weight, extremely durable planters with a 10-year warranty and all our products are manufactured in the USA.

Modern Colonial Garden Planter

Long-lasting beauty, durability, and quality. Built-in water reservoir encourages healthy plant growth by allowing plants to practically water themselves. Beautiful Modern Colonial design adds a charming touch to any patio or deck.



Item #	Desc	UPC	Vendor	CS/UOS	Location
80520403	16" Black	810738031111	MC16BK	1/1	East
80520402	16" White	810738031173	MC16WH	1/1	East
80520406	20" Black	810738032118	MC20BK	1/1	East
80520405	20" White	810738032170	MC20WH	1/1	East



Shiplap Planter

Long-lasting beauty, durability, and quality. Built-in water reservoir encourages healthy plant growth by allowing plants to practically water themselves. Beautiful Shiplap design adds a charming touch to any patio or deck.

Item #	Desc	UPC	Vendor	CS/UOS	Location
80520418	14" Black	810738029415	SL14BK	1/1	National
80520419	14" Safari	810738029439	SL14SF	1/1	National
80520420	14" White	810738029422	SL14WH	1/1	National
80520421	24" Black	810738029446	SL24BK	1/1	National
80520422	24" Safari	810738029460	SL24SF	1/1	National
80520423	24" White	810738029453	SL24WH	1/1	National



Modern Tall Square Planter

This fresh design of the modern planter provides a great touch to your outdoor space with a textured all-over finish.



Item #	Desc	UPC	Vendor	CS/UOS	Location
80520264	19" Black	810738025219	MSGT19BK	2/2	National
80520265	19" Espresso	810738025226	MSGT19ES	2/2	National
80520266	19" Slate	810738025202	MSGT19SL	2/2	National
80520260	23" Black	810738025110	MSGT23BK	2/2	National
80520261	23" Espresso	810738025127	MSGT23ES	2/2	National
80520262	23" Slate	810738025103	MSGT23SL	2/2	National

Modern Square Planter

This fresh design of the modern planter provides a great touch to your outdoor space with a textured all-over finish.



Item #	Desc	UPC	Vendor	CS/UOS	Location
80520272	16" Black	810738025417	MSQ16BK	4/4	National
80520273	16" Espresso	810738025424	MSQ16ES	4/4	National
80520274	16" Slate	810738025400	MSQ16SL	4/4	National
80520269	20" Espresso	810738025325	MSQ20ES	4/4	National
80520270	20" Slate	810738025301	MSQ20SL	4/4	National
80520268	20" Black	810738025318	MSQ20BK	4/4	National

Black Cosmo Planters

Quality planter with the classic look of clay and natural stone but without the expense, cracking, and heavy weight. Planter is rotation molded to achieve a natural look that is durable and weatherproof. Undrilled.



Item #	Desc	UPC	Vendor	CS/UOS	Location
80520093	26" Square Black	810738022911	CTU26BK	2/2	National
80520089	32" Square Black	810738022812	CUT32BK	2/2	National
80520064	26" Round Black	810738022218	CTR26BK	2/2	National

Urn Planter

Urn Planter - Rotation molded, lightweight planter. Weatherproof; resistant to heat and cold. Undrilled. Rock fill line in each pot. 10-year manufacturer's warranty. Contains 100% recycled materials.



Item #	Desc	UPC	Vendor	CS/UOS	Location
80520120	17" Black	810738023314	UR01BK	2/2	National

Garland Urn Planter

These urns are weatherproof. They are resistant to heat and cold. Each pot has drain plugs that are undrilled and a rock fill line.



Item #	Desc	UPC	Vendor	CS/UOS	Location
80520053	14"	810738021662	GU14WTC	6/6	National



Rolled Rim Pot

Made of lightweight, rotation molded plastic. Weatherproof so you can use it indoors or outdoors all summer and winter without worrying about fading or cracking.

Item #	Desc	UPC	Vendor	CS/UOS	Location
80520002	13 1/2" Sandstone	810738020146	RR135SS	6/6	National
80520001	13 1/2" Terra Cotta	810738020153	RR135TC	6/6	National
80520006	15 1/2" Terra Cotta	810738020252	RR155TC	6/6	National
80520017	24 1/2" Sandstone	810738020443	RR245SS	4/4	National
80520016	24 1/2" Terra Cotta	810738020450	RR245TC	4/4	National
80520021	30" Terra Cotta	810738020559	RR30TC	1/1	National
80520023	30" Espresso	810738020528	RR30ES	1/1	National
80520024	30" Black	810738020511	RR30BK	1/1	National
80520027	36" Sandstone	810738020641	RR36SS	1/1	National
80520026	36" Terra Cotta	810738020658	RR36TC	1/1	National
80520032	42" Sandstone	810738020740	RR42SS	1/1	National
80520031	42" Terra Cotta	810738020757	RR42TC	1/1	National

Lamb Planter

18" Plastic Blow-Mold Lamb Planter with pink accents. Has a 5" diameter opening.



Item #	Desc	UPC	Vendor	CS/UOS	Location
81320011	18"	078304516909	51690	6/6	East

Pig Planter

18 1/2" Plastic Blow-Mold Pig Planter. Has a 6" diameter opening.



Item #	Desc	UPC	Vendor	CS/UOS	Location
81320091	18 1/2"	078304533609	53360	6/6	East

Cow Planter

18 1/2" Plastic Blow-Mold Cow Planter with black spots. Has a 5" diameter opening.



Item #	Desc	UPC	Vendor	CS/UOS	Location
81320014	18 1/2"	078304533500	53350	6/6	East



Swan Planters

Plastic Blow-Mold Swan Planter with a yellow bill. Large swan stands about 16" tall, medium swan is 11" tall and small swan is 8" tall.

Item #	Desc	UPC	Vendor	CS/UOS	Location
81320008	8"	078304518200	51820	12/12	East
81320009	11"	078304518309	51830	12/12	East
81320007	16"	078304516800	51680	6/6	East
81320010	3 pieces	078304518606	51860	5/5	East

Round Grecian Urn Planter

Plastic blow-mold Grecian urn planter. Measures 16 1/2" tall x 15 1/4" in diameter. Urn has 12 1/2" opening on top for planting.



Item #	Desc	UPC	Vendor	CS/UOS	Location
81320039	Concrete	78304533005	53300	6/6	East
81320040	Black	78304533043	53304	6/6	East

Aztec Strawberry Jar

Plastic resin strawberry jar. Great for strawberries, flowers, hen-and-chicks, or herbs. 8" (4- 2" holes) 14" (12-2" holes)



Item #	Desc	UPC	Vendor	CS/UOS	Location
81320035	8"	078304528803	52880	12/12	East
81320036	14"	078304529008	52900	8/8	East

Black Cauldrons

This blow molded cauldron has a wider rim style that's a versatile favorite. No drainage.



Item #	Desc	UPC	Vendor	CS/UOS	Location
81320058	8" & 12" (4-sets)	078304553300	55330	4/4	East
81320059	12" & 16" (2-sets)	078304553508	55350	2/2	East
81320063	8" w/handle	078304552808	55280	12/12	East
81320034	8"	078304550804	55080	12/12	East

Dutch Kettle Planter

Styled like a cast iron classic, this black dutch kettle planter is crafted of heavy-duty plastic with 3 raised feet and handle.



Item #	Desc	UPC	Vendor	CS/UOS	Location
81320046	14"	078304552402	55240	6/6	East



All planters feature drain holes.

10" Hanging Watering Can Planter



4 assorted finishes, easy to assemble. All planters feature drainage holes. Watercolor; goldenrod, fuchsia, tangerine, and teal. Vintage; Assorted finishes

Item #	Desc	UPC	Vendor	CS/UOS	Location
80730445	Watercolor	727744800672	KDHWCWC	12/12	National
80731067	Vintage	727744801181	KDHWCVI	12/12	East

KD Watering Can Planter - Embossed Collection



10" Embossed Metallic Collection in Silver, Red, Purple, Teal with drainage holes.

Item #	Desc	UPC	Vendor	CS/UOS	Location
80730444	10"	727744800665	KDWC10EM	12/12	National



Hand Painted Floral KD Watering Can Planter

Metal planters, 4 assorted styles. All planters feature drainage holes.

Item #	Desc	UPC	Vendor	CS/UOS	Location
80731263	10"	727744803642	KDWC10HF	12/12	East



Bug Watering Can Planter

Metal bug watering can planters. 4 colors assorted, no assembly required! 10.5" x 4.75" x 4.5"

Item #	Desc	UPC	Vendor	CS/UOS	Location
80731303	4.5"	727744904059	FBWC4	24/24	East

KD Watering Can Planter - Vintage Collection



10" Vintage Collection in assorted finishes with drainage, easy to assemble.

Item #	Desc	UPC	Vendor	CS/UOS	Location
80730657	10"	727744801198	KDWC10VI	12/12	National

Vintage Oval Watering Can Planter



13" Oval KD Watering Can Planters in assorted finishes with drainage holes.

Item #	Desc	UPC	Vendor	CS/UOS	Location
80730553	13"	727744800979	KDWC13V	8/8	East



KD Watering Can Planter - Watercolor Collection

Metal planters, 4 assorted colors: fuchsia, goldenrod, tangerine, and teal. All planters feature drainage holes.

Item #	Desc	UPC	Vendor	CS/UOS	Location
80730128	7"	727744800436	KDWC7WC	12/12	National
80730120	10"	727744800368	KDWC10WC	12/12	National



Americana Watering Can Planters

4 assorted colors, easy to assemble. All planters feature drainage holes.

Item #	Desc	UPC	Vendor	CS/UOS	Location
80730113	10"	727744800351	KDWC10A	12/12	National



KD Watering Can Planters Polka Dot

10" KD Polka Dot Watering Can Planters. All planters feature drainage holes.

Item #	Desc	UPC	Vendor	CS/UOS	Location
80731336	10" Planter	727744904028	KDWC10PD	12/12	East



All planters feature drain holes.



Polka Dot Watering Can Planter

Metal Planters, two styles, no assembly required 6.5" x 6.5" x 6.3." All planters feature drainage holes.

Item #	Desc	UPC	Vendor	CS/UOS	Location
80730998	6.5"	727744802744	FPDWC6	12/12	East



Vintage Flower Shower Planter

Assorted Finishes - Embossed Design. Easy to assemble. All planters feature drainage holes. Round 10.5" x 10.5" x 8.25" Oval 17.25" x 9.25" x 6.75"

Item #	Desc	UPC	Vendor	CS/UOS	Location
80730888	10"-Round	727744801716	FSP10VI	12/12	East
80730887	17"-Oval	727744801723	FSO17VI	12/12	East



Key West Collection

Turquoise, Coral, Lilac, Lime. Easy to assemble.

Item #	Desc	UPC	Vendor	CS/UOS	Location
80730125	7" Planter	727744800504	KDWC7KW	12/12	East
80730117	10" Planter	727744800474	KDWC10KW	12/12	East
80730446	10" Hanging	727744800689	KDHWCKW	12/12	East

Galvanized Umbrella Planters

13" Galvanized Umbrella Hanging Planter with drainage holes.
18" Galvanized Umbrella Planter with drainage holes.



Item #	Desc	UPC	Vendor	CS/UOS	Location
80730879	13" Hanging	727744801884	FHUMB13	8/8	East
80730623	18" In-Ground Planter	727744801686	FUMB18	6/6	East



Bright Flower Shower Planter

17" Flower Shower Oval Planter water color collection teal, tangerine, goldenrod, fuchsia colors with drainage holes. 3 of each color per case pack.

10" Flower Shower Oval Planter water color collection teal, tangerine, goldenrod, fuchsia colors with drainage holes. 3 of each color per case pack.

Item #	Desc	UPC	Vendor	CS/UOS	Location
80730368	17" Key West- Oval	727744800603	FSO17KW	12/12	East
80730369	17" Watercolor- Oval	727744800597	FSO17WC	12/12	East
80730371	10" Watercolor-Round	727744800610	FSP10WC	12/12	East

Vintage Embossed Planters

These planters bring a rustic, farmhouse charm. Assorted finishes with rope handles. All planters feature drain holes.



Item #	Desc	UPC	Vendor	CS/UOS	Location
80731004	9"	727744802690	FVE9	12/12	East

Elegant Flowers & Garden Metal Planters

11" Elegant Flowers and Garden Metal Planter with metal handles and drainage holes. 3 of each color per case pack.



Item #	Desc	UPC	Vendor	CS/UOS	Location
80730508	11"	727744800856	FGPOT11	12/12	East



All planters feature drain holes.

Embossed Planter with White Rub

Metal planters in 4 colors: coral, blue, yellow, gray. All planters come with drainage holes.



Item #	Desc	UPC	Vendor	CS/UOS	Location
80731117	10" Assorted	727744803130	FEPR10	12/12	East



Oval Planters W/ Rope Handle

Metal Oval Daisy Planters with rope handles and drainage holes. Assorted colors, 3 of each color per case pack. 11.75" x 5.5" x 5"

Item #	Desc	UPC	Vendor	CS/UOS	Location
80731210	Oval Planters	727744803765	FOPRH12	12/12	East



Sun & Compass Planters

Metal Sun and Compass Planters in two colors with rope handles and drainage holes. 11" x 8.25" x 7"

Item #	Desc	UPC	Vendor	CS/UOS	Location
80731225	11"	727744803727	FSCP11	12/12	East



Metal Flowers & Garden Planters

Metal Flowers and Garden Planter with rope handles and drainage holes. Assorted colors. 10" x 10" x 7.75"

Item #	Desc	UPC	Vendor	CS/UOS	Location
80730946	10"	727744801730	MP109C	12/12	East

Beautiful Blooms Planters

"Beautiful Blooms" planters in 4 assorted finishes with drainage holes. 11.25" x 10.5" x 11."



Item #	Desc	UPC	Vendor	CS/UOS	Location
80730609	Beautiful Blooms Planters	727744801167	FBBA10	12/12	East

Flower Garden Metallic Planters

"Flowers & Garden" embossed planters in 4 assorted finishes with drainage 11" x 10" x 15.75."



Item #	Desc	UPC	Vendor	CS/UOS	Location
80730435	Flower Garden Planters	727744800641	FGMP	12/12	East



Vintage Paint Pail Planter

This planter can hang from the handle or sit on the porch.

Item #	Desc	UPC	Vendor	CS/UOS	Location
80730894	10" Assorted	727744801709	FVPP10	12/12	East



Zinc Colorful Mini Planter

Zinc Mini Colorful Flowers and Garden Planter with rope handles and drainage holes. 3 assorted colors. 6.25" x 3.75" x 4"

Item #	Desc	UPC	Vendor	CS/UOS	Location
80731008	6"	727744802799	FZMP6	24/24	East



Geometric Embossed Planter

Metal planters in 4 finishes, galvanized, fuchsia, teal, and rose gold with a white rub. All planters come with drainage holes. 11.25" x 8.75" x 7"

Item #	Desc	UPC	Vendor	CS/UOS	Location
80731308	11"	727744904110	FGEOP11	12/12	East



All planters feature drain holes.

Dotted Planter

Stylish metal planters are perfect accents for dropping in plants. 4 colors: white, teal, orange, and yellow. All planters feature drainage holes.



Item #	Desc	UPC	Vendor	CS/UOS	Location
80731304	7"	727744904066	FDOT7	24/24	East



Flowers Planters

Metal planters with rope handles feature drainage holes. Matte finish with an embossed pattern. 11" x 8.25" x 6.25." Four assorted colors, three each.

Item #	Desc	UPC	Vendor	CS/UOS	Location
80730996	11"	727744802706	FP11	12/12	East



Handpainted Floral Oval Planter

Handpainted floral oval metal planters in 4 colors: yellow, black, rose, and white. All planters come with drainage holes.

Item #	Desc	UPC	Vendor	CS/UOS	Location
80731310	17"	727744904042	FHPO17	12/12	East



Farmhouse Planter w/ Handle

Metal planters in 4 colors copper, black, white and galvanized. All planters come with drainage holes.

Item #	Desc	UPC	Vendor	CS/UOS	Location
80731307	7"	727744904080	FFPW7	24/24	East

Pail Planters

Metal pail planters in four assorted finishes. 10.75" x 7" x 8.5"



Item #	Desc	UPC	Vendor	CS/UOS	Location
80731219	10"	727744803680	FPPR10	12/12	East

Planter with Gold Bee

Stylish metal planters with honeycomb and a bee. All planters come with drainage holes. 2 assorted finishes



Item #	Desc	UPC	Vendor	CS/UOS	Location
80731312	Black/ Gold Bee Planters	727744904127	FPGB12	8/8	East

Round Vintage Planters

These planters bring a rustic, farmhouse charm. All planters feature drain holes. Two assorted finishes, 15.75" x 11.75" x 7.75"



Item #	Desc	UPC	Vendor	CS/UOS	Location
80731001	15"	727744802720	FRVP15	12/12	East

Barrel & Leaf Planters

Plastic resin planters upgrade any plant.



Item #	Desc	UPC	Vendor	CS/UOS	Location
80731212	10"	727744803468	FPLBL10	24/24	East



Pail Planter W/ Striped Paint

10" Metal Pail Planter in assorted colors with drainage. You can even display this planter by hanging it! 10.75" x 8" x 9"

Item #	Desc	UPC	Vendor	CS/UOS	Location
80731222	Pail Planter	727744803666	FPSP10	12/12	East



All planters feature drain holes.

Bug Pail Planters

8" Metal Pail Bug Planters in assorted colors with drainage holes 8" x 6" x 6.25"



Item #	Desc	UPC	Vendor	CS/UOS	Location
80730982	8"	727744802737	FBUG8	24/24	East



Wish Metal Planters

Metal planters in 4 accent colors pink, yellow, grey, and blue. All planters come with drainage holes.

Item #	Desc	UPC	Vendor	CS/UOS	Location
80731130	8" Assorted	727744803222	FWISH8	24/24	East

Ceramic Vines Planters

Purple and blue ceramic planters with drain holes 4.75" x 4.75" x 3.75"



Item #	Desc	UPC	Vendor	CS/UOS	Location
80731203	Vines Planter	727744803819	FCVP5	12/12	East

Metal Purse Planter

Charming galvanized purse planter with embossed dragonfly design. Able to hang as well! 10" x 5.51" x 7.87"



Item #	Desc	UPC	Vendor	CS/UOS	Location
80731311	10"	727744904097	FMPP10	6/6	East

Cement Planter w/ White Rub

Cement Planters with white rub 3"x3"x4"



Item #	Desc	UPC	Vendor	CS/UOS	Location
80731201	3"	727744803635	FCPWR3	12/12	East



Ceramic Insect Mug Planter

3 assorted styles; ladybug, dragonfly and butterfly.

Item #	Desc	UPC	Vendor	CS/UOS	Location
80730505	5"	727744801082	FCDMI5	12/12	East

Polka Dot Metal Teacup Planters

Bring the whimsical tea time experience to your garden or patio with these planters. Great teacher or Mother's Day gift items. All planters feature drain holes.



Item #	Desc	UPC	Vendor	CS/UOS	Location
80730997	5"	727744802751	FPDTC5	12/12	East

Antiqued Copper Pail

10" Antiqued Copper Pail.



Item #	Desc	UPC	Vendor	CS/UOS	Location
80731353	10"	727744904271	FACP10	12/12	National

Planter w/ Chalkboard Stand

Planter with Chalkboard Stand Planter is 10" Long x 9.5" Wide. Entire Piece is 18" Tall These unique galvanized planters bring a rustic, farmhouse charm. All planters feature drain holes.



Item #	Desc	UPC	Vendor	CS/UOS	Location
80730984	Chalkboard Planter	727744802645	FCHALK10	3/3	East



All planters feature drain holes.



Stars and Stripes Planters

Item #	Desc	UPC	Vendor	CS/UOS	Location
80730554	7" Watering Can	727744801105	KDWC7SS	12/12	National
80730551	10" Watering Can	727744801051	KDWC10SS	12/12	East
80730548	10" Hanging Watering Can	727744800993	KDHCWSS	12/12	National
80731006	12" Wide Wall Planter	727744802447	FWPSS	12/12	National
80730552	13" Oval Watering Can	727744800986	KDWC13SS	8/8	National
80730890	17" Oval	727744801747	FSSP17	12/12	National

Antiqued Stone Face Planter

Durable resin planter. All planters feature drain holes.



Item #	Desc	UPC	Vendor	CS/UOS	Location
80730978	4"	727744802812	FACE4	12/12	East

Branch & Trunk Planters

Trunk: 2.5" Opening, 4.5" Diam. x 7" Tall

Branch: 5.5" x 2" Opening, 8.25" Wide x 4" Long x 4" Tall



Item #	Desc	UPC	Vendor	CS/UOS	Location
80731302	Branch & Trunk Planters	727744904158	FBTP2	12/12	East

Turtle & Snail Planter

Resin turtle and snail planter 6" opening, 13" tall x 9" wide x 9" wide.



Item #	Desc	UPC	Vendor	CS/UOS	Location
80731316	6" Planters	727744904141	FTS6	4/4	East

12" Hanging Planter

12" Metal hanging planters with drain holes.



Item #	Desc	UPC	Vendor	CS/UOS	Location
80730517	A 12" Copper	727744801150	FZHP12C	12/12	East
80730763	B 12" Zinc	727744800702	FZHP12	12/12	East

Hedgehog, Owl, & Frog Planters

Resin planters. Two of each frog, owl, hedgehog.

Hedgehog: 5.75" Planter, 7.5" Wide x 11.5" Long x 6.5" Tall

Owl: 4.25" Planter, 9" Wide x 8" Long x 8.5" Tall

Frog: 5" Planter, 8.5" Wide x 12" Long x 6.5" Tall



Item #	Desc	UPC	Vendor	CS/UOS	Location
80731309	Animal Planter	727744904165	FHOF5	6/6	East



Hanging Colander Planter with Coco Liner

11" comes in 4 assorted colors, 8" comes in 2 assorted colors. Hanger and coco liner included.

Item #	Desc	UPC	Vendor	CS/UOS	Location
80730973	11" HB	727744802386	FCLHC11	12/12	East
80730985	8" HB	727744802775	FCLHC8	12/12	East



Ombre & Stripe Blue Red Planters

8" Plastic planters in assorted colors with drainage holes. Beautiful glossy finishes. Six of each color per case.

Item #	Desc	UPC	Vendor	CS/UOS	Location
80731215	8"	727744803444	FPLOS8	24/24	East



All planters feature drain holes.



Ceramic Shine Bright Planters

Ceramic shine bright planters come in two styles - pink drip gold dots and gold dots. Planters feature drainage holes. 4 x 4 x 3.5 in

Item #	Desc	UPC	Vendor	CS/UOS	Location
80731202	Shine Bright	727744803802	FCSBP4	24/24	East



Butterfly & Dragonfly Pail Planters

10" Butterfly and Dragonfly Pail Planters

Item #	Desc	UPC	Vendor	CS/UOS	Location
80731355	10"	727744904226	FBDPP10	12/12	East



Reclaimed Wood Planters

This is a set of 6 planters, pack 2 sets of 6 per case.

Item #	Desc	UPC	Vendor	CS/UOS	Location
80730884	Wood Planter Assortment	727744801822	FRWS6	2/2	East

Wood Crate Assortment

Planters in 4 colors. 2 of each color in each style. 2 styles – Assorted fluted and rectangular styles with drain holes. 22.5" Long x 10" Wide x 7" Tall. Made in USA



Item #	Desc	UPC	Vendor	CS/UOS	Location
80731053	22.5"	727744802881	PAWCA2	16/16	East

Hand Painted Floral Hanging Watering Can Planter

These easy to assemble watering can planters are great for additional sales by simply dropping in your potted plants. Features drain holes. Solid color special orders available.



Item #	Desc	UPC	Vendor	CS/UOS	Location
80731409	10"	727744904240	KDHWCHF	12/12	East



White & Black Planters

Set of 3 White and Black Planters.

Dimensions: Large: 11.5" Diameter x 9" Tall; Medium: 9.5" Diameter x 8" Tall; Small: 8.5" Diameter x 7" Tall

Item #	Desc	UPC	Vendor	CS/UOS	Location
80731390	Set of 3	727744904479	FWBPS3	4/4	East



People Planters

27" People Planters

Item #	Desc	UPC	Vendor	CS/UOS	Location
80731381	27"	727744904417	FPP27	8/8	East

Swinging Face Planter

5" Swinging Face Planter



Item #	Desc	UPC	Vendor	CS/UOS	Location
80731385	5"	727744904707	FSFP5	6/6	East

Wooden Rectangular Planter

*With Drain Holes



Item #	Desc	Vendor	CS/UOS	Location
82720003	Rectangular Planter Set of 3 (11"x8.5" 16"x10" 20"x12")	AMC 415	1/1	National

Potato Tub

Reusable potato planting container. Collapsible potato planting garden with drainage holes. Tough, heavy-duty polypropylene with strong stitched carry handles. 20"x16"



Item #	Desc	UPC	Vendor	CS/UOS	Location
81730061	Pack of 2	745487075058	7505	18/18	East

Wooden Square Planter

*With Drain Holes



Item #	Desc	Vendor	CS/UOS	Location
82720002	Square Wooden Planter Set of 3 (11.5", 14", 17")	AMC 336B	1/1	National



Standard Italians With Saucer

pricing per set - 12 or 6 per set depending on size - sold as 1/1

Item #	Desc	UPC	Vendor	CS/UOS	Location
81730982	4" Cobalt Blue 12pc	811421030602	W22 66300	1/1	East
81730983	4" Tropical Green 12pc	811421030626	W22 66500	1/1	East
81730984	4" Graphite 12pc	811421030633	W22 66600	1/1	East
81730985	6" Cobalt Blue 6pc	811421030657	W22 66800	1/1	East
81730986	6" Tropical Green 6pc	811421030671	W22 67000	1/1	East
81730987	6" Graphite 6pc	811421030688	W22 67100	1/1	East

Wooden Barrel Planter

*With Drain Holes



Item #	Desc	Vendor	CS/UOS	Location
82720001	Wooden Barrel Planter Set of 3 (13", 16", 18")	AMC 307	1/1	National

Wooden Acacia Round Trolley



Item #	Desc	Vendor	CS/UOS	Location
82720004	Acacia Round Trolley 12" w/ wheels	AMC 490R/30	12/12	National

Square Planter w/ Dragonflies

Square planter embossed with a beautiful dragonfly motif. Made of durable galvanized steel. Set of 3: small – 7.48" x 6.89" x 6.89" medium – 8.66" x 8.26" x 8.26" | large – 9.45" x 9.84" x 9.84" Case contains 4 sets of 3.



Item #	Desc	UPC	Vendor	CS/UOS	Location
81730646	Set of 3	814567028304	H16A1171	4/4	East

2025



Coco Liner Bulk Roll

Made from long lasting coco fibers with latex coating. Cut to shape for a perfect fit in all shapes of baskets or wall troughs.



Item #	Desc	UPC	Vendor	CS/UOS	Location
81730196	33' X 36"	745487009909	R990	1/1	East

Blacksmith Wall Trough With Coco Liner

Made from natural coco fiber and latex.



Item #	Desc	UPC	Vendor	CS/UOS	Location
81730184	30" Replacement liners	745487008797	R879	5/5	East
81730183	36" Replacement liners	745487008780	R878	10/10	East

Forge Wall Trough With Coco Liner

Old English styling and flat back for wall mounting.

Thicker, rust-resistant metal used throughout. This wall trough planter has a wider, deeper trough for additional soil to provide for stronger growth and reduce the frequency of watering.



Item #	Desc	UPC	Vendor	CS/UOS	Location
81730138	24" Trough & Coco	745487009428	R942	5/5	East
81730136	30" Trough & Coco	745487009398	R939	5/5	East
81730182	24" Replacement liners	745487008773	R877	10/10	East

Coco Basket Liners

Long lasting coco fibers, pre-formed for easy installation. The popular choice among consumers and growers.



Item #	Desc	UPC	Vendor	CS/UOS	Location
81730175	12" Round	745487005833	R583	25/25	East
81730176	14" Round	745487005840	R584	25/25	East
81730177	16" Round	745487005857	R585	25/25	East
81730189	20" Long	745487008919	R891	5/5	East

Traditional Hanging Basket w/ Coco Basket

Gardman traditional black metal banded hanging basket complete with coco liner.



Item #	Desc	UPC	Vendor	CS/UOS	Location
81730147	12"	745487004072	R407	15/15	East
81730148	14"	745487004089	R408	15/15	East
81730149	16"	745487004096	R409	15/15	East

Wire Grow Basket

16" coco basket with 4 leg heavy gauge hanger. Each basket has a pre-formed coco liner with a plastic dish to cover the base and creates a reservoir of water.



Item #	Desc	UPC	Vendor	CS/UOS	Location
81730027	16" - Black	745487004225	R422	25/25	East

Rustic Rattan Hanging Basket

Galvanized steel frames add strength and ensure long life. Plastic liner allows planter to be used indoors or out. When used outdoors it is recommended that drainage holes be made in the plastic liner.



Item #	Desc	UPC	Vendor	CS/UOS	Location
81730204	14" Hive Hanging Basket	745487002986	R298	10/10	East
81730215	16" Rattan Wall Basket	745487004966	R496	10/10	East
81730205	14" Rattan Half Hive Wall Basket	745487002993	R299	10/10	East

14" Forge Hanging Basket

Basket comes with pre-formed coco liner and heavy grade chain.



Item #	Desc	UPC	Vendor	CS/UOS	Location
81730142	14"	745487009466	R946	5/5	East

BIRDING SUPPLIES



CHECK OUT OUR
CLEARANCE ITEMS!



Griffin Greenhouse Retail WAREHOUSE Shipping Map

We are now shipping nationwide!

NATIONAL



2025

Refer to location key:

National items are stocked nationally
 Select items are sold East or West only; no exceptions

8" Kaleidoscope Planter

Premium plastic modular planter can be displayed individually each planter has a removable saucer ideal for succulents or shallow rooted planted.

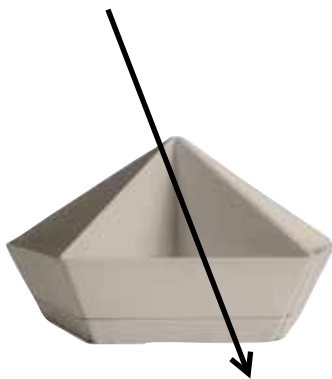

Item #	Desc	UPC	Vendor	CS/UOS	Location
80282643	Vanilla Bisque	770932844170	KDP08000A58	6/6	National

Where is the pricing?

1. Scan QR code on Chapter Pages to see pricing on Griffins.com
2. Contact your Griffin Sales Representative
3. Call into Griffin Customer Service 800.888.0054





Fiber Clay Bird Baths

Lightweight for easy transportation. Breaks down into three pieces for easy storage. Can be filled with sand for more stability. Measures 20" diam. x 20½" H.



Item #	Desc	UPC	Vendor	CS/UOS	Location
80690290	Stone	849637000294	BB05	4/4	East
80690289	Green	813001016464	BB04	4/4	East

Plastic Bird Bath

Resin plastic bird bath includes support stakes for extra stability. Lightweight for easy transportation. Breaks down into four pieces for easy storage.

Measures 19.5"x30".



Item #	Desc	UPC	Vendor	CS/UOS	Location
80690650	Bronze	849637003646	BB06	4/4	East



Copper Bird Feeder

This attractive copper feeder with stainless steel wire mesh will help attract finches to your yard.

Finch feeder 4"L x 4"W x 11.5"H - holds 1.5lbs of thistle seed

Sunflower feeder 4"L x 4"W x 11.5"H
Mesh openings are .25" x .25" - holds 1lbs of black oil sunflower seed



Item #	Desc	UPC	Vendor	CS/UOS	Location
82780004	Mesh Finch Feeder	789453010155	BC1000	6/6	National
82780006	Sunflower Bird Feeder	789453010148	BC400	6/6	National

Cotton Nest Ball

Help your birds by offering this ready-to-hang ball made of natural cotton. The gold finches love to pull on the cotton and use it to build their nests. Hang in a tree closest to your windows for the optimum bird-watching experience! (Raw cotton, not processed)



Item #	Desc	UPC	Vendor	CS/UOS	Location
82780041	Cotton Nest Ball	789453200204	CNB	12/12	National

Plastic Fly Thru

This attractive Birds Choice Recycled Plastic Fly-Thru Bird Feeder is a maintenance-free durable bird feeder constructed with recycled poly lumber material.



Item #	Desc	UPC	Vendor	CS/UOS	Location
82780009	Bristol Black	789453010193	BCFTBB	2/2	National
82780010	Navy Peony	789453009920	BCFTNP	2/2	National
82780012	Sage Green	789453009944	BCFTSG	2/2	National

Plastic Hanging Tray

This attractive, made in the USA, hanging platform bird feeder is a maintenance-free durable bird feeder constructed with recycled poly lumber material. Expanded mesh stainless steel screen provides excellent drainage to keep seed dry. Stainless steel hanging rods, 9.75"L x 9.75"W x 2" H



Item #	Desc	UPC	Vendor	CS/UOS	Location
82780023	Sage Green	789453009821	BCHTSG	6/6	National

Recycled Plastic Bird House

This attractive, made in the USA, wren house is constructed with recycled poly lumber material.

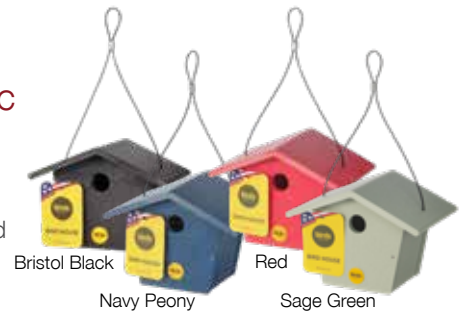

Item #	Desc	UPC	Vendor	CS/UOS	Location
82780033	Bristol Black	789453010230	BCWHBB	2/2	National
82780034	Navy Peony	789453009968	BCWHNP	2/2	National
82780035	Red	789453009975	BCWHRD	2/2	National
82780036	Sage Green	789453009982	BCWHSG	2/2	National

Port Tube Bird Feeder

This economy tube feeder features feeding ports and a green metal top and bottom.

2 port- 8" Tube, w/hanger 13"H- holds 2 cups of seed.

4 port- 11" Tube, w/hanger 16"H - holds 3 cups of seed.



Item #	Desc	UPC	Vendor	CS/UOS	Location
82780052	2 Port	789453962034	LCTUBE	12/12	National
82780049	4 Port	789453962041	LCLGTUBE	12/12	National



Butterfly Feeder

This feeder offers two ways to attract butterflies with its 12 oz. nectar capacity and fruit trays. Made of plastic. 9"L x 9"W x 9.5"H w/rod



Item #	Desc	UPC	Vendor	CS/UOS	Location
82780053	12oz Butterfly Feeder	789453300072	NP1001	12/12	National

Hummingbird & Oriole Nectar

This 8 oz. resealable pouch of hummingbird and oriole nectar is 100% sucrose. Makes 4 cups of hummingbird nectar or 6 cups of oriole nectar.



Item #	Desc	UPC	Vendor	CS/UOS	Location
82780055	8oz Concentrate	789453300126	NP1003	12/12	National

Butterfly Nectar

This 7.5 oz resealable pouch of butterfly nectar is specifically formulated for butterflies. Makes 6 cups of nectar.



Item #	Desc	UPC	Vendor	CS/UOS	Location
82780056	7.5oz Concentrate	789453300119	NP1005	12/12	National

Squirrel Proof Feeder Inc pole/baffle

This squirrel proof classic bird feeder with pole and squirrel baffle features a large seed reservoir made from UV resistant polycarbonate. Total height is 5 ft. 8 in. Polycarbonate tube is 6" in diameter and 12" in length. Holds approximately 5lbs of seed.



Item #	Desc	UPC	Vendor	CS/UOS	Location
82780063	Squirrel Proof	789453300010	NP431	4/4	National



Squirrel Buster® Series

Truly Squirrel-proof™



Classic (A)

Clinging and perching birds have easy access to the food ports that are aligned with the wire shroud. Dismantles for easy cleaning

Item #	Desc	UPC	Vendor	CS/UOS	Location
80430002	1.5 qt.	628209010158	1015	2/2	East

Plus (B)

Guaranteed effective against grey squirrels. The six bottom seed ports close from the weight of the squirrel that forces the shroud over the seed ports. Top selling cardinal friendly feeder! 6.5W x 6.5L x 23.75H.

Item #	Desc	UPC	Vendor	CS/UOS	Location
80430001	3 qt.	628209010240	1024	2/2	East

Mini (C)

Compact design is easy to fill, chew proof, and features 4 seed ports. 4.13"L x 4.13"W x 12.38"H

Item #	Desc	UPC	Vendor	CS/UOS	Location
80430005	3/4 qt.	628209010554	1055	4/4	East

Standard (D)

The patented squirrel proof design has chew-proof components. The weight adjustable closing mechanism, patented Seed Tube Ventilation system, and proven Seed Saver Technology, with stainless steel perches are award winning features. 5"W x 5"L x 13.25/H.

Item #	Desc	UPC	Vendor	CS/UOS	Location
80430006	3/4 qt.	628209010578	1057	4/4	East

Legacy (E)

Openings in the shroud align with seed ports, providing birds access to the food. When a squirrel climbs onto the feeder, its weight automatically forces the shroud down, closing access to the seed. 5.5"L x 5.5"W x 16"H

Item #	Desc	UPC	Vendor	CS/UOS	Location
80430010	1 1/2 qt.	628209010820	1082	2/2	East

Weather Guard For Squirrel Buster Plus Feeder

Give your songbirds shelter and keep the rain out of your Brome Squirrel Buster Plus bird feeder with this weather guard accessory! UV protected polycarbonate. Feeder not included.



Item #	Desc	UPC	Vendor	CS/UOS	Location
80430008	13"	628209010264	1026	4/4	East

Squirrel Buster Finch

Openings in the shroud align with the feeding ports, providing birds access to the food. When a squirrel climbs onto the feeder, its weight automatically forces the shroud down, closing access to the ports. 4 Perches and 8 Feed Ports



Item #	Desc	UPC	Vendor	CS/UOS	Location
80430003	1.5 Quart	628209010165	1016	2/2	East

Pole Adaptor For Squirrel Buster Plus Feeder

Mount your Squirrel Buster Plus feeder anywhere in your yard using the new pole adaptor. The powder coated die cast pole adaptor fits any 1" pole and comes with a stainless steel mid ring to thwart squirrels.



Item #	Desc	UPC	Vendor	CS/UOS	Location
80430007	Mount Kit	628209010257	1025-V01	4/4	East

CENTURION®

Quality, Value & Innovation

Wild Triple Bird Feeder

3 in 1 multi-feeder! Use the clear tube for your average seed, the small mesh section for thistle seed for your finches, and the large mesh section for peanuts or suet balls. 8.27" x 14.17" powder coated metal+PC. Seed capacity 4.5lbs, features 4 perches.



Item #	Desc	UPC	Vendor	CS/UOS	Location
82760090	Wild Triple Bird Feeder	845049016359	1635	2/2	National

Traditional Wren House

Fully assembled and easy to hang with attached cable from small branches or hooks. The hole size is specific to wrens and prevents larger birds from entering. Features a heavy cable from hanging with screwed together construction.



Item #	Desc	UPC	Vendor	CS/UOS	Location
82760191	7.28"x7.48"x6.3"	845049016892	1689	8/8	National

Wren & Chickadee House

Air vents allow for proper air ventilation through wall and floor openings. Clean-out door allows easy access to clean between broods. Grooves on the inside of the house just below the entry hole enable the young to climb up to feed and peer out at the world around them. An added predator guard extends over the entrance hole to help protect young birds against predators



Item #	Desc	UPC	Vendor	CS/UOS	Location
82760190	5.5"x7.1"x11"	845049022145	2214	8/8	National

Hexagon Shape Bird Feeder

This Hexagon Shape Bird Feeder has 2.3 lbs large capacity, is constructed of durable plastic, features an inclined roof to shade birds from sun and rain. Tray style feeding port allows birds to feed from all angles. Feeder equipped with a twist lock cover to keep the lid safely closed. Steel hanging string comes fully assembled.



Item #	Desc	UPC	Vendor	CS/UOS	Location
82760094	2.3 lb	845049016519	1651	2/2	National

Metal Bird Feeder

Durable, all metal feeder with swing-proof hook and easy twist off design, built-in drainage holes and seed diverter. Designed to attract all backyard finch varieties.

0.5lb Feeder- 4.75" x 4.75" x9"
1.6lb Feeder- 6" x 6" x 13.5"



Item #	Desc	UPC	Vendor	CS/UOS	Location
82760115	0.5 lb	845049023098	2309	6/6	National
82760114	1.6 lb	845049023081	2308	3/3	National

Capacity Sunflower & Wild Bird Feeder

Built-in seed diverter. Drainage holes help seeds stay dry. Twist-off top and base for easy fill and clean. Weather resistant powder-coated metal construction.



Item #	Desc	UPC	Vendor	CS/UOS	Location
82760118	4 lb.	845049023203	2320	6/6	National

Squirrel Resistant Globe Cage Tube Bird Feeder

All-steel globe cage, deters squirrels. 4 Feed ports & perches attracts birds from all sides. Transparent feed tube to monitor supply at a glance. Weather resistant powder-coated metal construction. 9" X 9" x 9.5"



Item #	Desc	UPC	Vendor	CS/UOS	Location
82760120	2 lb.	845049023227	2322	4/4	National

Antique Copper Finch Feeder

Brushed copper vintage finish. Easy-clean design. 2 Feeding ports, 4 perches, measures 7.48" X 7.45" X 12.2"



Item #	Desc	UPC	Vendor	CS/UOS	Location
82760121	3 lb.	845049023234	2323	6/6	National

Metal 2-in-1 Bird Feeder

Heavy duty, all-steel construction. 360° Perch attracts birds from all directions. Clear-view tube and mesh feeders. Holds two types of seeds. Attracts more birds in a small space. Measures 8.27" X 8.27" X 10.43"



Item #	Desc	UPC	Vendor	CS/UOS	Location
82760123	3 lb.	845049023258	2325	6/6	National

Metal Suet Cage

Cage grid design optimized for clinging birds. Durable all-steel construction. Fits standard suet cakes up to 5 inch x 6 inch.



Item #	Desc	UPC	Vendor	CS/UOS	Location
82760117	1 cake	845049023173	2317	20/20	National

Heavy-Duty Bird Feeder

Durable all-steel construction. 6 Mesh feed ports with perches. Designed to hold peanuts or seed. Convenient lift up roof for easy access. Measures 4.13" X 4.13" X 13.78"



Item #	Desc	UPC	Vendor	CS/UOS	Location
82760124	6 feeding stations	845049023265	2326	6/6	National

Large Clear-View Tube Bird Feeder

6 Ports & perches attracts birds to all sides. Raise up roof for easy filling. Clear-view tube to check feed level at a glance. Steel hanger securely holds cover in place. Measures 2.76" X 2.7" X 17.3"



Item #	Desc	UPC	Vendor	CS/UOS	Location
82760126	6 port	845049024118	2411	6/6	National

Mega Tube Feeder

Ergonomic perches design. 6 Feed ports with perches. Scratch resistant clear-view feed tube. Versatile installation options include top hanging loop or pole socket in base. Measures 6.3" X 6.3" X 17.72"



Item #	Desc	UPC	Vendor	CS/UOS	Location
82760127	6 Port	845049024132	2413	6/6	National

Vintage Glass Hummingbird Feeder

Attract hummingbirds with this vintage-looking feeder with an easy-to-fill glass bottle that's simple to clean. With a decorative hanging hook and copper base, this feeder is sure to add more beauty to your garden.



Item #	Desc	UPC	Vendor	CS/UOS	Location
82760091	10oz	845049016427	1642	6/6	National
82760107	20 oz	845049018308	1830	6/6	National

Hummingbird Feeder

Attract hummingbirds with the red cover as they drink from one of three feeding ports. With a generous 16.5-ounce capacity, sturdy construction, and a suction-cup mounted bracket, you will find this feeder is a great addition to your existing feeding setup. Easy cleaning and filling also makes this a great feeder for hummingbird beginners! The attractive design attracts hummingbirds right to the window for easy viewing. Measures 8.66" x 6.49" x 1.77"



Item #	Desc	UPC	Vendor	CS/UOS	Location
82760109	16.5 oz	845049018391	1839	6/6	National

Plastic Hummingbird Feeder

Centurion's plastic Hummingbird Feeder is made from heavy-duty plastic with anti-corrosion and anti-aging properties for durable, long-time use. With four perches and four ports, your hummingbirds can stay longer and feed as long as they please. Measures 9" x 5.9" x 9.84"



Item #	Desc	UPC	Vendor	CS/UOS	Location
82760093	32oz	845049016496	1649	12/12	National



Glass Hummingbird Feeder (A)

The Centurion Clear Glass 10oz Hummingbird Feeder is designed to bring the beauty of hummingbirds to your garden with ease. Its sturdy construction, combined with user-friendly features, ensures a delightful experience for both you and the birds. The feeder's clear glass reservoir allows you to monitor nectar levels, while its bright red and yellow accents attract hummingbirds effortlessly. Measures 6.3" x 6.3" x 8.9"

Item #	Desc	UPC	Vendor	CS/UOS	Location
82760007	10oz	845049000983	98	6/6	National

Hummingbird Feeder (B)

Built-in Perches. 24.5oz Capacity With 4 Feeding Stations. No melt all-season suet cake. Measures 6.1" x 6.1" x 9.25"

Item #	Desc	UPC	Vendor	CS/UOS	Location
82760105	24.5 oz	845049018216	1821	2/2	National

Clear Hummingbird Feeder (C)

Centurion's 32 oz. Hummingbird Feeder has 4 feeding ports with bright yellow flower to attract bird. Clear, shatter proof reservoir makes it easy to monitor nectar levels for refilling, and unscrews easily from the feeder base for quick cleaning. Measures 4.53" x 4.53" x 9.45"

Item #	Desc	UPC	Vendor	CS/UOS	Location
82760092	32oz	845049016465	1646	12/12	National

Hummingbird Feeder (D)

31.5 Oz capacity with 4 feeding stations. Measures 6.1" X 6.1" X 9.25"

Item #	Desc	UPC	Vendor	CS/UOS	Location
82760108	31.5 oz	845049018384	1838	6/6	National

Glass Bottle Hummingbird Feeder

Wide opening for easy filling & cleaning. Sturdy 20 oz. glass nectar reservoir. 5 bright white flower feeding ports. Base comes apart for easy cleaning. Built-in water moat keeps ants away. Measures 6.1" x 6.1" x 9.25"



Item #	Desc	UPC	Vendor	CS/UOS	Location
82760184	20oz	845049025016	2501	6/6	National

Glass Bottle Hummingbird Feeder

Built-in perches. 5 bright white flower ports. Base comes apart for easy cleaning. Sturdy 20 oz. glass nectar reservoir.



Item #	Desc	UPC	Vendor	CS/UOS	Location
82760193	20oz	845049025023	2502	6/6	National



Niger Seed

Often mistakenly called Thistle seed, is a favorite of beautiful wild finches like the American Goldfinch. It is best used in a specifically designed tubular feeder with small holes where it can be economically dispensed.

Item #	Desc	UPC	Vendor	CS/UOS	Location
80370024	5 lb.	751478100739	NI05	6/6	East
80370025	10 lb.	751478100746	NI10	4/4	East

Oil Sunflower

Over 99% pure and cleaned four times to ensure that you get more seed and fewer sticks. Plus it's positively chock full of oil. You want as much oil in your sunflower as you can get because that's what attracts the birds. High-grade, high-oil sunflower means more birds at your bird feeder.

Item #	Desc	UPC	Vendor	CS/UOS	Location
80370021	8 lb.	751478100616	OS08	4/4	East
80370022	16 lb.	751478100661	OS16	2/2	East

Raw Peanuts

Higher in essential fat and protein than peanut hearts and pieces, Raw Peanuts are a great attraction for titmice, nuthatches, wrens, and woodpeckers.

Item #	Desc	UPC	Vendor	CS/UOS	Location
80370030	5 lb.	751478100937	RP05	6/6	East
80370031	10 lb.	751478100944	RP10	4/4	East

Safflower Seed

Safflower is a lifesaver for those of you having trouble with squirrels. Most squirrels and blackbirds don't like it, while cardinals, nuthatches, and chickadees can't resist it. So if you're tired of feeding more squirrels than birds, Safflower is definitely for you.

Item #	Desc	UPC	Vendor	CS/UOS	Location
80370009	5 lb.	751478100432	SA05	6/6	East
80370010	10 lb.	751478100449	SA10	4/4	East
80370011	20 lb.	751478100456	SA20	2/2	East

Sunflower Meats

This is pure sunflower and the birds' number one choice. With almost no shell, you get more feed per pound and no messy hulls to clean up. It's perfect if you want to feed from balconies and decks without the mess of leftover shells.

Item #	Desc	UPC	Vendor	CS/UOS	Location
80370013	5 lb.	751478100531	SM05	6/6	East
80370014	10 lb.	751478100548	SM10	4/4	East
80370015	20 lb.	751478100555	SM20	2/2	East

Hot Meats®

Nutritious sunflower meats infused with fiery hot habanero chilies, Hot Meats® are a great no waste, no mess feed. Bluebirds and cardinals are especially fond of the hot Cajun flavor. With Cole's Hot Meats® you'll get more bird visits than ever before.

Item #	Desc	UPC	Vendor	CS/UOS	Location
80370017	5 lb.	751478101439	HM05	6/6	East
80370018	10 lb.	751478101446	HM10	4/4	East
80370019	20 lb.	751478101453	HM20	2/2	East

Special Feeder®

This unique mix is a high energy treat for many birds. Cole's most popular blend because it attracts the greatest number of wild birds than any other mix out there. Plus woodpeckers absolutely love the pecans.

Item #	Desc	UPC	Vendor	CS/UOS	Location
80370005	5 lb.	751478100333	SF05	6/6	East
80370006	10 lb.	751478100340	SF10	4/4	East
80370007	20 lb.	751478100357	SF20	2/2	East



Finch Friends®

Developed for use in a regular tubular feeder, no thistle feeder needed. Just fill up your everyday feeder with Finch Friends® and soon beautiful goldfinches, purple finches, and pine siskins will be dining at your door. Contains sunflower meats & niger seeds.

Item #	Desc	UPC	Vendor	CS/UOS	Location
80370027	5 lb.	751478101231	FF05	6/6	East

Nutberry Suet Blend®

Combines all of nature's best in one delicious blend. Attract fruit and insect loving songbirds to your feeder with this unique mix of premium fruits, preferred nuts, nutritious insect Suet Kibbles®, and whole kernel sunflower meats. Bluebirds, warblers, robins, woodpeckers and more absolutely love this special treat. This is the ultimate trail mix for your wild birds.

Item #	Desc	UPC	Vendor	CS/UOS	Location
80370043	5 lb.	751478100234	NB05	6/6	East
80370044	10 lb.	751478100241	NB10	4/4	East
80370045	20 lb.	751478100258	NB20	2/2	East

Blazing Hot Blend®

100% all natural, chemical free way to increase the number of birds visiting your feeder. It combines habanero chili oil formula with the most preferred seeds of backyard songbirds. Woodpeckers, grosbeaks, buntings, cardinals, chickadees, bluebirds, goldfinches, and more find this mix irresistible.

Item #	Desc	UPC	Vendor	CS/UOS	Location
80370051	5 lb.	751478102535	BH05	6/6	East
80370052	10 lb.	751478102542	BH10	4/4	East
80370053	20 lb.	751478102559	BH20	2/2	East

Blue Ribbon Blend®

A traditional mix done right, Cole's guarantees you'll get the best combination of perching and ground feeding birds with this one. So, just fill up your feeder and stand back.

Item #	Desc	UPC	Vendor	CS/UOS	Location
80370001	5 lb.	751478100135	BR05	6/6	East
80370002	10 lb.	751478100142	BR10	4/4	East
80370003	20 lb.	751478100159	BR20	2/2	East

Critter Munchies®

Critter Munchies® works well in a platform feeder or scattered on the ground. Either way squirrels, chipmunks, and rabbits can't get enough. Contains whole yellow corn, striped sunflower, peanuts in the shell, black oil sunflower, and raw peanuts.

Item #	Desc	UPC	Vendor	CS/UOS	Location
80370039	5 lb.	751478101132	CM05	6/6	East

Cajun Cardinal®

Even wild birds like a little Cajun spice now and then, so we've combined the fiery hot chilies of Hot Meats® with Safflower (a favorite of cardinals) to create a sure-fire winner for all your chickadees, titmice, woodpeckers, bluebirds, and of course – cardinals.

Item #	Desc	UPC	Vendor	CS/UOS	Location
80370047	5 lb.	751478101538	CB05	6/6	East
80370048	10 lb.	751478101545	CB10	4/4	East

Cracked Corn

Cracked Corn is an inexpensive feed that appeals to a wide range of ground feeding birds such as cardinals, white-throated sparrows, towhees, ducks, and doves.

Item #	Desc	UPC	Vendor	CS/UOS	Location
80370036	5 lb.	751478100838	CC05	6/6	East



Special Feeder® Suet Cake

Chock full of pecans and peanuts, it's a shoe-in to be your woodpecker's favorite suet. It is best served during the cooler months of fall and winter.



Item #	Desc	UPC	Vendor	CS/UOS	Location
80370056	11 oz.	751478100326	SFSU	12/12	East

Natural Peanut Suet Cake

This special no melt formula wins taste tests hands down. With the peanut butter base that birds prefer, it's two steps above your average peanut suet.



Item #	Desc	UPC	Vendor	CS/UOS	Location
80370058	12 oz.	751478101927	NPSU	12/12	East

Blue Ribbon Blend® Suet Cake

A "Better" all-purpose soft suet that attracts the largest variety of songbirds. Full of much needed calories and fiber, Blue Ribbon Blend™ suet cakes are a great substitute for insects during the fall and winter months.



Item #	Desc	UPC	Vendor	CS/UOS	Location
80370055	11 oz.	751478100128	BRSU	12/12	East

Hot Meats® Suet Cake

Our famous best seller presented in a No Melt, No Mess suet cake. Made with nutritional sunflower meats and fiery hot chillies, your favorite birds will go crazy for the hot Cajun flavor!



Item #	Desc	UPC	Vendor	CS/UOS	Location
80370057	12 oz.	751478101422	HMSU	12/12	East

Flaming Squirrel® Seed Sauce

A nutritional birdseed supplement that contains all natural, 100% food grade ingredients with a super hot and spicy flavor. Birds love the taste of this liquid chili pepper formula exploding with tons of Cajun spice. When mixed with your favorite birdseed, it's guaranteed to increase bird visits at your feeder.



Item #	Desc	UPC	Vendor	CS/UOS	Location
80370065	8 oz.	751478102429	FS08	12/12	East

Dried Mealworms

Easier to feed and less messy than live mealworms, these energy packed morsels are Mother Nature's perfect treat for all your insect loving songbirds.



Item #	Desc	UPC	Vendor	CS/UOS	Location
80370063	3 1/2 oz.	751478102313	DRMW	6/6	East
80370064	28 oz.	751478102320	DMLG	4/4	East



Hummingbird Feeder

4 feeding ports. Full perch ring. Easy to clean and refill. Wire hanger included.

Item #	Desc	UPC	Vendor	CS/UOS	Location
80400195	18 oz	085199221412	HUM141	6/6	National

Mini Feeder

Heath Hummingbird Feeder Mini (Holds 3 oz) in Counter Display. Bringing nature closer. Easy to clean. Display can fit on peg hooks or be placed on shelf.



Item #	Desc	UPC	Vendor	CS/UOS	Location
80400107	3 oz.	85199223126	HUMF23	28/28	National

Ant Moat Hummingbird Feeder Flower

The Heath Flower Ant Moat hangs conveniently above your hummingbird or oriole feeder to prevent crawling insects from contaminating the nectar. Simply fill the cup with water and insects will be unable to climb down.



Item #	Desc	UPC	Vendor	CS/UOS	Location
80400321	Yellow Ant Moat	085199114011	AM-1	12/12	National

High Energy Suet Cake

No melt all-season suet cake. High energy blend perfect for year round feeding.

Attracts these colorful songbirds: Cardinals, Chickadees, Goldfinches, Juncos, Kinglets, Nuthatches, Purple Finches, Siskins, Tanagers, Thrushes, Titmice, Warblers, Woodpeckers and Wrens.



Item #	Desc	UPC	Vendor	CS/UOS	Location
80400199	9.5 oz	085199042086	DD412A	16/16	National

Berry Blast Suet Cake

Heath Berry Blast Suet is produced by blending the highest quality natural ingredients available. Suet cakes are ideal for attracting colorful songbirds. Place suet cake in suet cage and hang approximately 6ft off ground. Refill cage when empty.



Item #	Desc	UPC	Vendor	CS/UOS	Location
80400119	11.25 oz.	085199050159	DD-15	12/12	National

Peanut Crunch Suet Cake

Attract a variety of backyard birds with Heath's Peanut Crunch Suet Cake. The cake features a blend of suet, seeds and peanut pieces that will attract birds year round.



Item #	Desc	UPC	Vendor	CS/UOS	Location
80400120	11.25 oz.	085199050180	DD-18	12/12	National

Classic Double Suet Basket

Feeds twice as much as a standard suet cage. Holds two standard-sized suet cakes. Vinyl-coated weather-resistant metal cage. Front panel opens for quick and easy refilling. Attached hanging chain



Item #	Desc	UPC	Vendor	CS/UOS	Location
80400022	Suet Basket	085199080026	S-2	8/8	National

Green Metal Suet Feeders

Holds standard-sized suet or seed cake. Vinyl-coated metal cage is weather-resistant. Front panel opens for easy filling. Birds are able to feed from all surfaces. Hanging chain attached.



Item #	Desc	UPC	Vendor	CS/UOS	Location
80400021	Single	085199080019	S-1-8	24/24	National

Citrus Grove Suet Cake

Citrus Grove suet cakes are blended with sunflower seeds, safflower, grains and orange flavoring to attract a variety of colorful songbirds. Suet cakes are a great treat during migration and winter-months and our cakes are perfect for-year-round feeding with our no-melt formula. Guaranteed fresh.



Item #	Desc	UPC	Vendor	CS/UOS	Location
80400134	9.25 oz	085199050234	DD-23	16/16	National

Multi-Grain Suet Cake

Multi-grain suet to attract colorful songbirds. Mixed sunflower seeds, grains and peanut flavoring.



Item #	Desc	UPC	Vendor	CS/UOS	Location
80400132	9.25 oz	085199050210	DD-21	16/16	National

Very Berry Suet Cake

Very Berry suet cake is a of mixed with corn, sunflower seeds, seeds, berry flavoring and oats.



Item #	Desc	UPC	Vendor	CS/UOS	Location
80400133	9.25 oz	085199050227	DD-22	16/16	National

Fancy Blend Suet Cake

Fancy Blend suet is a of mixed sunflower seeds, grains and blueberry flavoring.



Item #	Desc	UPC	Vendor	CS/UOS	Location
80400131	9.25 oz	085199050203	DD-20	16/16	National

Bird's Blend Suet Cake

High energy blend perfect for year round feeding. Attracts these colorful songbirds: Cardinals, Chickadees, Goldfinches, Juncos, Kinglets, Nuthatches, Purple Finches, Siskins, Tanagers, Thrushes, Titmice, Warblers, Woodpeckers and Wrens. Guaranteed fresh.



Item #	Desc	UPC	Vendor	CS/UOS	Location
80400117	9.25 oz	085199042000	DD4-12	12/12	National



The Butterfly Bird Feeder

Holds 3 pounds of mixed seed. 4 feeding ports. Durable steel and plastic construction. Hammered silver color finish. Top unscrews for refilling and cleaning.



Item #	Desc	UPC	Vendor	CS/UOS	Location
80400181	Butterfly Feeder	085199212397	21239	4/4	National

Parkview Bird Feeder

Holds up to 1 pound of mixed seed. Durable steel and plastic construction for year-round feeding. 4 feeding ports around the base. Drainage holes help prevent water build-up and wasted seed. Top unscrews for refilling and cleaning.



Item #	Desc	UPC	Vendor	CS/UOS	Location
80400266	Antique White	085199215343	21534	4/4	National

Clementine Oriole Feeder

Feeds 2 orange halves, grape jelly, nectar or mealworms. Resembles an orange half. Durable UV-resistant powder-coated steel. Simplistic design offers a clear view of orioles as they feed. Glass cup removes for cleaning. Attached hanging chain.



Item #	Desc	UPC	Vendor	CS/UOS	Location
80400188	Oriole Feeder	085199131339	CF-133	6/6	National



Suet 'n Seed Animal Feeders

These whimsical animal designs hold 2 standard suet cakes in the cage or a single. Ideal for filling with Black Oil sunflower seeds, sunflower seed hearts, chopped nuts, and larger seed mixes.

Item #	Desc	UPC	Vendor	CS/UOS	Location
80400278	Owl	085199217033	21703	5/5	National
80400284	Frog	085199218030	21803	5/5	National
80400283	Penguin	085199218023	21802	5/5	National

Tube Seed Bird Feeders

Tube-style feeder. 6 feeding ports and holds up to 2 pounds of seed. Easy to clean and refill. Wire hanger included.



Item #	Desc	UPC	Vendor	CS/UOS	Location
80400040	Tube Feeder	085199003926	392	6/6	National

Giddy-Up Bird Feeder

Decorative tube feeder. Hammered copper finish. Holds 2 pounds of mixed seed. 4 feeding ports with perches. Top overhangs to help protect birds. Durable steel and plastic construction. Top unscrews for refilling and cleaning.



Item #	Desc	UPC	Vendor	CS/UOS	Location
80400038	Feeder	085199212304	21230	6/6	National

Grand Palace Bird Feeder

Feed the birds, not the squirrels. Intricate cage design helps protect against squirrels. Holds up to 1 pound of mixed seed. Durable steel and plastic construction for year-round feeding. 4 feeding ports within the safety of the cage. Top unscrews for refilling and cleaning.



Item #	Desc	UPC	Vendor	CS/UOS	Location
80400268	Grand Palace Feeder	085199215367	21536	2/2	National

Cotton Candy Bird Feeder

Made of durable steel and plastic for year-round use, it can hold up to 1 pound of mixed seed and has 4 feeding ports with perches and rain guards. Interior seed deflectors help seed flow smoothly. Top lifts for easy cleaning and refilling.



Item #	Desc	UPC	Vendor	CS/UOS	Location
80400243	Blue	085199395007	395	3/3	National
80400245	Pink	085199396004	396-2	2/2	National

Bat House Display Pack

The Heath Outdoor Product Single Bat House can be mounted on a pole, or under the eaves of a house, garage or barn approximately 12-15 feet above the ground. Made in the USA from weather-resistant cedar. Brown bats can consume 600 mosquitos in an hour, helping to naturally control insects.



Item #	Desc	UPC	Vendor	CS/UOS	Location
80400100	Bat House	085199101028	BAT-1	4/4	National

Hummer's Galore

Ant Moat

Keep pesky ants and insects out of your feeder. Attractive red tulip design enhances the feeder and larger hook openings on top and bottom fit most shepherds hooks and are provided for easy hanging. 5 oz capacity.



Item #	Desc	UPC	Vendor	CS/UOS	Location
82400010	Ant Moat	075792114204	MOAT	12/12	National

Bee Guard Replacement Base

Simply attach the screw on base to the bottle on your Hummers Galore Hummingbird Feeders. Pops apart for easy cleaning



Item #	Desc	UPC	Vendor	CS/UOS	Location
82400011	Bee Guard	075792440051	BEE	6/6	National

Nectar

Make Bird Watching the best by using the enticing Hummingbird nectar, all natural, no preservatives or artificial color. Concentrate makes 64 ounces of Nectar.



Item #	Desc	UPC	Vendor	CS/UOS	Location
82400009	4 pack 16 oz.	075792100160	NEC	12/12	National



HUMMINGBIRD FEEDER

Glass bottle feeders screw into plastic base. Flowers are laser printed on plastic base.

Item #	Desc	UPC	Vendor	CS/UOS	Location
82400004	All American 16 oz.	075792220165	AA16	12/12	National
82400002	Vine 16 oz.	075792110169	VINE16	12/12	National
82400005	Blue Sky 16 oz.	075792330161	SKY16	12/12	National
82400008	Hibiscus 16 oz.	075792440167	HIB16	12/12	National
82400003	All American 32 oz.	075792220325	AA32	12/12	National
82400001	Vine 32 oz.	075792110329	VINE32	12/12	National
82400006	Blue Sky 32 oz.	075792330161	SKY32	12/12	National
82400007	Hibiscus 32 oz.	075792330321	HIB32	12/12	National



MILITARY HUMMINGBIRD FEEDERS

Glass bottle feeders screw into plastic base. Flowers are laser printed on plastic base.

Item #	Desc	UPC	Vendor	CS/UOS	Location
82400040	Army 32 oz.	075792460072	ARMY32	12/12	National
82400039	Navy 32 oz.	075792460059	NAVY32	12/12	National
82400037	Air Force 32 oz.	075792460011	USAF32	12/12	National
82400038	Marines 32 oz.	075792460035	USMC32	12/12	National

Cleaning Brush

A tool to clean the inside of the Hummers Galore glass bottle hummingbird feeder (sold separately). Highly durable with 5" bristles that are curved at the bottom to clean hard to reach areas.



Item #	Desc	UPC	Vendor	CS/UOS	Location
82400042	Cleaning Brush	075792218216	BRUSH	6/6	National

Farmhouse Vertical Feeder

Made with naturally insect and rot resistant premium cedar. Extra spacing to accommodate larger birds like Cardinals and Jays.
14"H x 7"W x 8.25"D



Item #	Desc	UPC	Vendor	CS/UOS	Location
82250098	2lb / 1.5qt	857505008648	WWLF1-DECO	4/4	National

Farmhouse Wren House

Made with naturally insect and rot-resistant premium cedar. Air vents allow for maximum air ventilation through wall and floor openings.
8.25"H x 7.25"W x 7.25"D



Item #	Desc	UPC	Vendor	CS/UOS	Location
82250096	Wren House	857505008662	WWLH2-DECO	4/4	National

Farmhouse Bluebird House

The elegant feel and innovative design of this Farmhouse Bluebird House are sure to make it a quick favorite! Clean-out doors provide easy access for cleaning. An added predator guard extends the entrance hole to protect young birds against predators. Made with naturally insect and rot resistant premium Cedar. 11"H x 6.75"W x 6"D



Item #	Desc	UPC	Vendor	CS/UOS	Location
82250097	Bluebird house	857505008679	WWLH3-DECO	4/4	National

Squirrel Shield Choice Metal Feeder

Keep squirrels off your feeder! Collapsing seed cover keeps squirrels from getting to your seed. 4 feeding seed ports, ideal for Mixed seed/Sunflower. Holds 3qts 20.25"H x 7.83"W x 7.83"D



Item #	Desc	UPC	Vendor	CS/UOS	Location
82250006	Mixed Seed/Sunflower 3 qt	850028089330	SPTUB-1	4/4	National

Farmhouse Hopper Bird Feeder

Holds 3qt Sunflower/Mixed seed and two suet bars 11"Hx12.5"Wx6"D



Item #	Desc	UPC	Vendor	CS/UOS	Location
82250099	2 Suet Cages	857505008655	WWLF2-DECO	4/4	National

Squirrel Shield Hopper Feeder

Add a splash of farmhouse charm to your backyard birding experience while keeping the squirrels at bay! Collapsing perches under the weight of a squirrel. 10.75"H x 10.63"W x 10.50"D



Item #	Desc	UPC	Vendor	CS/UOS	Location
82250011	Holds 5.8qt	850028089002	SPHOP-1	1/1	National

Farmhouse Tube Feeder

Unique hanger design connects to outside of tube, for the easiest filling and less seed spilling. Holds 2.8qt 17"H x 7"W x 7"D



Item #	Desc	UPC	Vendor	CS/UOS	Location
82250100	Brown	857505008952	WWWPRB-DECO	6/6	National
82250101	Silver	857505008723	WWW-MRS-DECO	4/4	National

Contemporary Lantern Metal Gazebo

Add a touch of elegance to your yard with this contemporary metal lantern gazebo bird feeder! This feeder features a channeled and perforated base for better water drainage, keeping your seed fresh longer. The seed diverter base directs seed to the feeding area, while four fold-out perches provide ample space for small and large birds.



Item #	Desc	UPC	Vendor	CS/UOS	Location
82250122	1.56 qt	850028089699	GAZ-12	4/4	National

Cedar Bat House

Made with insect and rot resistant premium cedar. Landing kerfs for easy grip landing. Removable inserts for cleaning.



Item #	Desc	UPC	Vendor	CS/UOS	Location
82250082	Singe Chamber	850023007902	CWH10	2/2	National

Bluebird Box House

Cedar Bluebird Box House with easy clean out doors, and fledgling kerfs inside making it easy for young to climb out. 12" H x 5.5" W x 8" D



Item #	Desc	UPC	Vendor	CS/UOS	Location
82250079	Bluebird Box House	857907005597	CWH3	4/4	National

Cedar Wren Hanging Bird House

Wren house made of durable cedar material. Constructed with rust-free hardware. 8" x 9" x 8"



Item #	Desc	UPC	Vendor	CS/UOS	Location
82250078	Hanging Wren house	857907005580	CWH1	4/4	National

Box Wren House

Wild Wings Cedar Box Wren House is made with naturally insect and rot resistant premium Cedar for a durable house that will last multiple seasons. Air vents allow for proper air ventilation through wall and floor openings to promote bird health. A clean-out door provides easy access for cleaning. 8"H x 5"W x 7"D



Item #	Desc	UPC	Vendor	CS/UOS	Location
82250077	Wren house	857505008778	WWTH4	4/4	National

Cedar Bluebird Viewing House

Cedar bird house with clear viewing window. Elevated rust free wire mesh floor aids in the management of blowfly infestation. Easy clean out doors, and fledgling kerfs inside making it easy for young to climb out. 12" H x 7.5" W x 8" D



Item #	Desc	UPC	Vendor	CS/UOS	Location
82250080	Cedar viewing house	857907005603	CWH4	4/4	National



A



B



C

My First™ Bird House w/ Viewing Window (A)

Have more fun with this hands-on learning experience when you build and decorate My First Bird House together! Perfect for workshops, this Kit comes with easy to follow directions, 6 acrylic paints, 2 paintbrushes, coloring sheet, stickers, all wood pieces, and nails. Bird house is 9.75"H x 5.75"W x 6.75"D

Item #	Desc	UPC	Vendor	CS/UOS	Location
82250001	Bird house kit	857505008976	DIY-BIRD	8/8	National

My First™ Wren House (B)

Kit comes with easy to follow directions, 6 acrylic paints, 2 paintbrushes, coloring sheet, stickers, all wood pieces, and nails. Size kit box is 10.04"H x 5.2"W x 2.4" D

Item #	Desc	UPC	Vendor	CS/UOS	Location
82250002	Wren kit	857505008969	DIY-WREN	8/8	National

My First™ Pollinator House (C)

Have more fun with this hands-on learning experiences with your child when you build and decorate My First Pollinator House together! Perfect for pollinator workshops or pollinator week promotions! Kit comes with easy to follow directions, 6 acrylic paints, 2 paintbrushes, coloring sheet, stickers, nails, all wood and bamboo pieces. 10.12"H x 6"W x 2.4"D

Item #	Desc	UPC	Vendor	CS/UOS	Location
82250003	Pollinator kit	857505008983	DIY-BEE	8/8	National



Decorative Suet Cage Bird Feeder - Single Cake

Add a touch of rustic floral charm to your birding experience with this decorative single suet cage bird feeder! 6.5"H x 6.69"W x 6.0"D



Item #	Desc	UPC	Vendor	CS/UOS	Location
82250128	1 Cake Cage	850028089729	WWSUET-2	6/6	National

Basic Suet Cage Bird Feeder - Single Cake

The simple design and durable construction of this single suet cage bird feeder will provide you with hours of birding enjoyment! 5"H x 4.75"W x 1.75"D



Item #	Desc	UPC	Vendor	CS/UOS	Location
82250127	1 Cake Cage	850028089712	WWSUET-1	6/6	National

Country Cottage Gazebo Bird Feeder

Country Cottage Gazebo bird feeder is perfect for accommodating larger birds like cardinals and jays. Bottom tray has drainage feature, that allows air to flow and water to drain. Great for sunflower and mixed seed. Has seed diverter to feeding tray for even distribution. 9.8"H x 6.25"W x 6.25"D Holds 1.56 quarts



Item #	Desc	UPC	Vendor	CS/UOS	Location
82250103	Cottage Sunflower Feeder	850028089262	GAZ-H1	4/4	National

Paisley Sky Gazebo Bird Feeder

Paisley print Gazebo style bird feeder that's perfect for accommodating larger birds like cardinals and jays. Bottom tray has drainage feature that allows air to flow and water to drain. Great for sunflower and mixed seed. Has seed diverter to feeding tray for even distribution. 11.3"H x 7.5"W x 7.5"D Holds 3.7 quarts



Item #	Desc	UPC	Vendor	CS/UOS	Location
82250104	Paisley Gazebo	850028089255	GAZ-D2	4/4	National

Better Gardens Farmhouse Bee Barn

Bring a unique farmhouse look to your garden and increase plant health naturally with beneficial insect houses. 11"H x 6.9"W x 4.21"D



Item #	Desc	UPC	Vendor	CS/UOS	Location
82250055	Pollinator Barn	857505008952	PWH17	6/6	National

Better Gardens Farmhouse Bee Home

Naturally maintain and improve the health of the plants in your yard, landscape, or garden by attracting beneficial insects! Bamboo shoots offer a natural nesting location. 8.5"H x 5"W x 4.5"D



Item #	Desc	UPC	Vendor	CS/UOS	Location
82250051	Farmhouse Bee House	857505008907	PWH8	6/6	National

Fantasy Floral Easy Clean Tube Feeder

Plastic Fantasy Floral Easy-Clean tube feeder features easily removable ports for cleaning. The wide tube and unique hanger attachment enable easy refilling. Thistle seed inserts included too! Accommodates large birds like cardinals. Holds 2.8qts. 16.5"H x 7"W x 7"D



Item #	Desc	UPC	Vendor	CS/UOS	Location
82250064	Fantasy Floral Easy Clean Tube Feeder	850028089316	WWWP3-S	6/6	National

Red Seed Plastic Tube Feeder

This feeder's wide opening and unique hanger design make for easy filling with less spill! Easy Clean feeder base is easily removable for thorough cleaning and proper feeder care. Adequate port spacing allows for both large and small birds to feed comfortably, attracting a wider variety of birds. 6 feeding ports for maximum bird viewing. 18.5"H x 6.75"W x 6.75"D



Item #	Desc	UPC	Vendor	CS/UOS	Location
82250160	Large Red Seed Plastic Tube Feeder	850049312288	PS35186	4/4	National

Vintage Blossom Decorative Glass Hummingbird Feeder

Easy fill and clean hummingbird feeder with two part base and removable flower feeding ports. Built in ant moat on top of feeder deters unwanted pests from reaching feed. Built in perches. Holds up to 20oz 10.5"H x 6.5"W x 6.5"D



Item #	Desc	UPC	Vendor	CS/UOS	Location
82250023	Red Blossom HB Feeder	085002808071	DGHF3	6/6	National

Charming Peony Decorative Glass Hummingbird Feeder

Easy fill and clean hummingbird feeder with two part base and removable flower feeding ports. Built in ant moat on top of feeder deters unwanted pests from reaching feed. Built in perches. Holds up to 20oz 10.5"H x 6.5"W x 6.5"D



Item #	Desc	UPC	Vendor	CS/UOS	Location
82250022	Peony HB Feeder	850028089064	DGHF2	6/6	National



*Display pack pictured

Mason Jar Hummingbird Feeder

Easy-Fill and Clean™ Mason Jar Hummingbird Feeder. Dishwasher safe for even easier cleaning. Holds up to 6oz. 2.5"H x 4"W x 4"D

Item #	Desc	UPC	Vendor	CS/UOS	Location
82250024	Case pack of 6	857505008280	MJF1	6/6	National
82250025	Display pack of 9	857505008280	MJF1-TRAY	9/9	National

Traditional Window Hummingbird Feeder

Easy-Fill and Clean™ Window Hummingbird Feeder with suction cup mounting system. Three feeding stations with perches. Bee resistant dome shape of feeder lid creates space between nectar and deters bees and wasps. Holds up to 8oz 9"H x 8"W x 2.5"D



Item #	Desc	UPC	Vendor	CS/UOS	Location
82250028	Window HB Feeder	857505008259	TWF1	6/6	National

Decorative Top-Fill Glass Hummingbird Feeder

Easy fill and clean glass hummingbird feeder with floral perch space. All parts are easily removable and are dishwasher safe. Holds 13oz. Comes in giftable packaging. 9.8"H x 7"W x 5.25"D



Item #	Desc	UPC	Vendor	CS/UOS	Location
82250031	13oz Green	850028089217	DTHF2	4/4	National



Artisan Gravity Hummingbird Feeder

Artisan hummingbird feeders have a two part base and removable flower feeding ports to allow complete disassembly for the most thorough cleaning. Hummingbird feeder has perches and life like flower ports

Item #	Desc	UPC	Vendor	CS/UOS	Location
82250037	A Blush Crackle	857505008792	AGF1	4/4	National
82250039	B Sunny Day	857505008815	AGF3	4/4	National
82250038	C Spring Rain	857505008808	AGF2	4/4	National

Ribbed Rose Gravity Hummingbird Feeder

Unique design creates an easy-to-use hummingbird feeder combined with a one-of-a-kind look that will be a favorite for both you and the hummingbirds! Glass reservoir with 7 feeding ports, plastic base



Item #	Desc	UPC	Vendor	CS/UOS	Location
82250113	28 oz	850028089781	TGF5	6/6	National

Scarlet Swirl Gravity Hummingbird Feeder

Built-in hummingbird perches allow for more hummingbird perching space to maximize hummingbird viewing. Five flexible lifelike flower ports with leak free fit for maximum feeding comfort. 7.5"H x 6.5"W x 6.5"D Glass reservoir with plastic base



Item #	Desc	UPC	Vendor	CS/UOS	Location
82250112	20 oz	850028089774	TGF4	6/6	National



Ruby Visions Antique Glass Gravity Hummingbird Feeder

Attract more hummingbirds to your yard with this antique textured glass hummingbird feeder! Built-in continuous hummingbird perch ring allows more hummingbird perching space to maximize hummingbird viewing. 10"H x 5.5"W x 5.5"D



Item #	Desc	UPC	Vendor	CS/UOS	Location
82250116	25 oz	850028089873	ANTGHF6	6/6	National

Antique Glass Gravity Hummingbird Feeder

Easy-Fill and Clean™ Antique glass hummingbird feeder has a two part base and removable flower feeding ports to allow complete disassembly for the most thorough cleaning. Hummingbird feeder has perches, and bee resistant dome shaped feeder ports that deter bees and wasps. Holds 28oz. 9.77"H x 6.35"W x 6.35"D



Item #	Desc	UPC	Vendor	CS/UOS	Location
82250036	Antique HB Feeder	850028089309	ANTGHF2	6/6	National

Lilac Dreams Antique Glass Gravity Hummingbird Feeder

Attract more hummingbirds to your yard with this antique textured glass hummingbird feeder! Built-in continuous hummingbird perch ring allows more hummingbird perching space to maximize hummingbird viewing. 9.5"H x 5.5"W x 5.5"D



Item #	Desc	UPC	Vendor	CS/UOS	Location
82250115	29 oz	850028089866	ANTGHF5	6/6	National

Crimson Carnation Antique Glass Gravity Hummingbird Feeder

Attract more hummingbirds to your yard with this antique textured glass hummingbird feeder! Built-in continuous hummingbird perch ring allows more hummingbird perching space to maximize hummingbird viewing. 9"H x 5.5"W x 5.5"D



Item #	Desc	UPC	Vendor	CS/UOS	Location
82250118	22 oz	850049312066	ANTGHF12	6/6	National

Replacement Flowers

Nature's Way Hummingbird Feeder Replacement Flowers can be used to replace damaged or missing ports or customize the look of your hummingbird feeder! Compatible with all current models of Nature's Way hummingbird feeders and any alternative hummingbird feeder with a 1/4" port opening!



Item #	Desc	UPC	Vendor	CS/UOS	Location
82250153	16 pieces per pack	850049312332	IMPTRED16	10/10	National

Cherry Glass Hummingbird Feeder

Unique design creates an easy-to-use hummingbird feeder combined with a one-of-a-kind look that will be a favorite for both you and the hummingbirds! Built-in hummingbird perches allow for more hummingbird perching space to maximize hummingbird viewing. Two-part base system and removable flower ports allow feeder to be completely disassembled for thorough cleaning. 7"H x 5.5"W x 5.5"D



Item #	Desc	UPC	Vendor	CS/UOS	Location
82250111	13 oz	850028089767	TGF3	6/6	National

PANACEA®

Strawberry Hummingbird Feeder

Plastic strawberry shaped hummingbird feeder, with a removable base, easy to clean and fill, 4 feeding ports.



Item #	Desc	UPC	Vendor	CS/UOS	Location
80440253	40 oz.	047977009407	24126	4/4	National

Aqua Glass Hummingbird Feeder

Hummingbird Feeder hangs from hooks or tree branches near a colorful flower bed. Recycled glass feeder holds 8 oz. of nectar. Three bright red feeding flower feeding ports. Clean by hand with soft foam brush between filling.



Item #	Desc	UPC	Vendor	CS/UOS	Location
80440459	Aqua Hummingbird Feeder	093432249734	24973	4/4	National

Rustic Wren Farmhouse

Rustic bird and butterfly birdhouses with tin and barnboard accents.



Item #	Desc	UPC	Vendor	CS/UOS	Location
80440294	Wren House 7.25"x7.25"x6.5"	093432287101	28710	4/4	National

Rustic Farmhouse Silos

Our Rustic Farmhouse brand is on-trend and incorporates popular materials like galvanized, roofs and bases. This thistle feeder is made with a durable steel mesh and an easy open top for filling with .5 lb. of seed. Attract the smaller perching birds that enjoy thistle like chickadees, finches, goldfinches, redpolls, and siskins. Hunter green tops and bottoms. Drain holes in seed tray.



Item #	Desc	UPC	Vendor	CS/UOS	Location
80440300	Nyjer	093432287163	28716	6/6	National

National Audubon™ Traditional Wren House

Made of natural cedar and fir. Ventilated and easy to clean design. Built to Audubon specifications. Has a 1 1/8" hole. 6.8"D x 7.1"W x 6 1/4"H



Item #	Desc	UPC	Vendor	CS/UOS	Location
80440224	Wren	715038306580	24305	4/4	National

National Audubon™ Bluebird House

Made of natural cedar. Ventilated and easy to clean design. Built to Audubon specifications. Has a 1 9/16" hole. 6.4"D x 6.4"W x 11 3/4"H



Item #	Desc	UPC	Vendor	CS/UOS	Location
80440083	Bluebird	715038302025	24225	3/3	National

Squirrel-Resistant Bird Feeder

Firm locking lid opens easy for surrounding cage keeps out squirrels and larger birds. Bottom tray with drain holes provide perching space for multiple birds. Two of each color, blue, orange, green, and red.



Item #	Desc	UPC	Vendor	CS/UOS	Location
80440666	2.5lb Seed 7" X 10"	093432246429	24642	8/8	National

Round Mesh Feeders

Easy to fill with any type of seed. Holds approximately 1 cup of small birdseed blend, may vary depending on the type of seed you use. Birds can eat from the rim or hop inside during bad weather. Metal mesh gridwork attracts clinging birds like finches and nuthatches.



Item #	Desc	UPC	Vendor	CS/UOS	Location
80440438	Mesh Feeder	093432245835	24583	8/8	National

Nantucket White Copper Ranch Feeder

Nantucket styling ranch feeder is a fusion of coastal weathered white wood with the refinement of a copper roof. This hopper style ranch feeder has a 5-lb mixed seed capacity and the clear plastic hopper lets you monitor seed levels. Easy open hinged roof creates ease in filling and heavy cable is included for hanging. Decorative and functional, a beautiful addition to any backyard or garden!



Item #	Desc	UPC	Vendor	CS/UOS	Location
80161817	Ranch Feeder	093432254387	25438	2/2	National

Nantucket White Copper Wren House

Protect smaller cavity nesting wrens. Ornithologically correct birdhouse with a coppertop roof to deflect heat in warm weather. Your nestlings stay cool and comfortable until they fledge. Includes hanging cable with built-in ventilation and drainage. Decorative whitewashed finish. Made from cedar and naturally weather-resistant. 8 x 6-3/4 x 9-1/2 inches tall.



Item #	Desc	UPC	Vendor	CS/UOS	Location
80161818	Wren House	093432254394	25439	2/2	National

Yard Hanger

Ideal for hanging larger bird feeders, hummingbird feeders, flower baskets, wind chimes, or garden ornaments. Holds up to 25 lbs.

Item #	Desc	UPC	Vendor	CS/UOS	Location
80440163	88"	715038302216	24288	3/3	National

Metal Deck Railing Bird Bath

An elegant deck mounted birdbath with a distinctive textured hammered copper finish.



Item #	Desc	UPC	Vendor	CS/UOS	Location
80440430	14" Dia.	093432238165	23816	3/3	National



Birdhouses

A chain and hook come included for easy installation and easy move in for your feathered friends.

Item #	Desc	UPC	Vendor	CS/UOS	Location
80230434	A Deco Birdhouse Bungalow 6/cs	759834560197	56019	6/6	National
80230431	B Deco Birdhouse Raindrop 6/cs	759834560265	56026	6/6	National
80231405	C Birdhouse Log House 6/cs	759834560142	56014	6/6	National
80230555	D Birdhouse Woven Maison Med. 6/cs	759834560524	56052	6/6	National
80230121	E Birdhouse Woven Raindrop 6/cs	759834560104	56010	6/6	National
80230594	F Woven Raindrop Med. Wicker 6/cs	759834560500	56050	6/6	National
80231201	G Woven Raindrop Med. 6/cs	759834560517	56051	6/6	National
80230120	H Birdhouse Woven Maison 6/cs	759834560128	56012	6/6	National
80230422	I Birdhouse Woven Bungalow Large 6/cs	759834560135	56013	6/6	National
80230556	J Birdhouse Woven Bungalow Med. 6/cs	759834560609	56053	6/6	National
80230686	K Birdhouse Woven Gazebo 6/cs	759834560012	56001	6/6	National
80230432	L Deco Birdhouse Shack 6/cs	759834560159	56015	6/6	National
80230781	M Birdhouse Plantable Maison 6/cs	759834560029	56002	6/6	National

Dove Woven Bird Feeder

SuperMoss Woven Bird Feeders are extremely durable and meant for outdoor and garden use. Wild birds are naturally attracted to the materials and the feeders maintain their shape through weather and will last multiple years.



Item #	Desc	UPC	Vendor	CS/UOS	Location
80230689	Bird Feeder Dove 7" Small 6/cs	759834569008	56900	6/6	East
80230690	Bird Feeder Dove 9.5" Large 6/cs	759834569015	56901	6/6	East

Sparrow Woven Bird Feeder

SuperMoss Woven Bird Feeders are extremely durable and meant for outdoor and garden use. Wild birds are naturally attracted to the materials and the feeders maintain their shape through weather and will last for multiple years.



Item #	Desc	UPC	Vendor	CS/UOS	Location
80230691	Bird Feeder Sparrow 7" Small 6/cs	759834569022	56902	6/6	National
80230692	Bird Feeder Sparrow 9.5" Large 6/cs	759834569039	56903	6/6	National



Butterfly Ready-To-Use Nectar

All-natural, dye-free, citrus and wildflower-infused ready-to-use butterfly nectar. Made with pure cane sugar, dye-free, clear formula.



Item #	Desc	UPC	Vendor	CS/UOS	Location
82180018	250 ml	632726256173	B-BRTU-250	12/12	National
82180006	750ml Glass Bottle	712038079698	N-BRTU	12/12	National

Hummingbird Nectar Concentrate

All-natural, dye-free, wild flowerinfused hummingbird nectar concentrate (makes 3X). Fortified with calcium to promote healthy egg development and electrolytes to aid in the prevention of dehydration. No unnecessary food coloring or harmful preservatives.



Item #	Desc	UPC	Vendor	CS/UOS	Location
82180001	750ml Glass Bottle	661799213745	N-HCON	12/12	National
82180007	Bag 1.5L	712038079612	B-HCON-M	4/4	National



Hummingbird Nectar Powder Concentrate

All-natural, dye-free powder hummingbird nectar concentrate (makes over 1 liter). Fortified with calcium to promote healthy egg development and electrolytes to aid in the prevention of dehydration. No unnecessary food coloring or harmful preservatives.



Item #	Desc	UPC	Vendor	CS/UOS	Location
82180021	8 oz	632726256371	P-HCON-8	12/12	National



Hummingbird Ready-To-Use Nectar

All-natural, dye-free, wildflower-infused ready-to-use hummingbird nectar. Fortified with calcium to promote healthy egg development and electrolytes to aid in the prevention of dehydration. No unnecessary food coloring or harmful preservatives.

Item #	Desc	UPC	Vendor	CS/UOS	Location
82180012	250 ml Pouch	712038203741	B-HRTU-250	12/12	National
82180002	750ml Glass Bottle	045635922730	N-HRTU	12/12	National
82180011	Bag 1.5L	712038079636	B-HRTU-M	4/4	National
82180010	Bag 3L	632726256357	B-HRTU-L	6/6	National



Oriole Ready-To-Use Nectar

All-natural, dye-free, citrus-infused ready-to-use oriole nectar. Fortified with calcium to promote healthy egg development and electrolytes to aid in the prevention of dehydration. No unnecessary food coloring or harmful preservatives.

Item #	Desc	UPC	Vendor	CS/UOS	Location
82180015	250 ml Pouch	632726256296	B-ORTU-250	12/12	National
82180004	750ml Glass Bottle	712038079711	N-ORTU	12/12	National
82180014	Bag 1.5L	632726256234	B-ORTU-M	4/4	National

Oriole Concentrate Nectar

Clear oriole nectar concentrate infused with citrus. Sweet-Nectar™ ready-to-use oriole nectar is infused with all-natural citrus extracts that your orioles will love. Added calcium promotes healthy egg development and electrolytes aid in the prevention of dehydration. No unnecessary food coloring or corn syrup here! Made with pure cane sugar, dye-free, clear formula.



Item #	Desc	UPC	Vendor	CS/UOS	Location
82180003	750ml Glass Bottle	661799213714	N-OCN	12/12	National

Butterfly Concentrate Nectar

Create your very own backyard butterfly sanctuary by offering up feeders filled with Sweet-Nectar all natural butterfly nectar. Our blend is infused with a proprietary blend of the all natural fruit and flower extract most loved by a wide variety of butterflies.



Item #	Desc	UPC	Vendor	CS/UOS	Location
82180005	750ml Glass Bottle	045635082427	N-BCON	12/12	National



Round Bird Bath

White resin birdbath. 22" x 17" x 31". Made of durable weather resistant plastic. Top needs to be assembled to base with 3 provided screws.

Item #	Desc	UPC	Vendor	CS/UOS	Location
81320048	White	78304610102	61010	6/6	East



Striped Sunflower Seeds

A premium striped sunflower seed selected for high oil and nutrient content. Striped sunflowers contain less oil than black oil sunflowers, but provide variety for seed-eating birds.



Item #	Desc	UPC	Vendor	CS/UOS	Location
82100076	15 lb	719195363158	363150	1/1	National

Shelled Peanuts

An all-natural food source for all wild birds and wildlife, Wild Delight® shelled peanuts are premium grade, unprocessed, uncooked and not salted. Woodpeckers, Jays, Doves, Songbirds, Squirrels, Chipmunks, Ducks and other outdoor pets



Item #	Desc	UPC	Vendor	CS/UOS	Location
82100054	10 lb	719195380056	380050	4/4	National

Nyjer Seed

A cleaned, premium-grade thistle that has been sterilized to prevent germination. American Goldfinches, Purple Finches, House Finches, Cassin's Finches, Pine Siskins and Redpolls.



Item #	Desc	UPC	Vendor	CS/UOS	Location
82100068	5 lb	719195383057	383050	6/6	National

Black Oil Sunflower Seeds

A premium black oil sunflower seed selected for high oil and nutrient content for all seed-eating birds.



Item #	Desc	UPC	Vendor	CS/UOS	Location
82100072	5 lb	719195596051	361050	6/6	National
82100074	20 lb	719195361208	361200	1/1	National

Feast for Wild Birds

A wholesome, natural wild bird food containing millet, safflower and black oil sunflower seeds.



Item #	Desc	UPC	Vendor	CS/UOS	Location
82100056	5 lb	719195371054	371050	8/8	National

Safflower Seed

This premium-select, high-oil seed is preferred by cardinals. Normally, squirrels, jays, starlings and grackles will not eat safflower seed due to its bitter taste.



Item #	Desc	UPC	Vendor	CS/UOS	Location
82100077	8 lb	719195386089	386080	4/4	National

Buffet Wild Bird Food

A wholesome, natural wild bird food for all seed-eating birds.



Item #	Desc	UPC	Vendor	CS/UOS	Location
82100059	10 lb	719195391106	391100	4/4	National
82100060	20 lb	719195391205	391200	1/1	National

Corn On The Cob

A premium corn on the cob. Squirrels, ducks, geese, raccoons and other wildlife. Squirrels, ducks, geese, raccoons and other wildlife.



Item #	Desc	UPC	Vendor	CS/UOS	Location
82100050	7 lb	719195388076	388070	4/4	National

Pink Finch Sock

The Wild Delight® Finch Sock Feeder is an all-in-one feed and feeder that contains only the finest premium grade Nyjer® Seed*, an oil seed preferred by finches and other birds.



Item #	Desc	UPC	Vendor	CS/UOS	Location
82100065	13 oz	719195383040	383040	12/12	National

Outdoor Finch Food

A special blend of premium ingredients for finches. American goldfinches, house finches, purple finches, chickadees, song sparrows, indigo buntings, exotic parakeets and more.



Item #	Desc	UPC	Vendor	CS/UOS	Location
82100062	5 lb	719195375052	375050	6/6	National

Golden Finch Food

A premium outdoor bird food blended to attract finches and buntings, filled with ingredients these birds love and touched with hues of harvest gold. Attracts and feeds American goldfinches, house finches, purple finches, buntings, chickadees, nuthatches and other outdoor birds

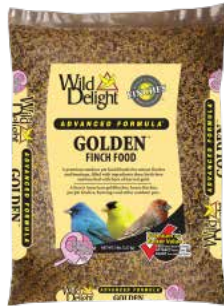

Item #	Desc	UPC	Vendor	CS/UOS	Location
82100013	5 lb	719195373058	373050	6/6	National

Sizzle N' Heat

A premium hot blend designed for BIRDS ONLY. Cardinals, finches, nuthatches, jays, chickadees, titmice, grosbeaks and other outdoor birds.



Item #	Desc	UPC	Vendor	CS/UOS	Location
82100034	11.8oz Suet	719195372174	372175	12/12	National
82100011	5 lb	719195372051	372050	6/6	National
82100012	14 lb	719195372143	372140	3/3	National

Mealworms

Feed alone or mix with your favorite wild bird food. Attracts and feeds bluebirds, nuthatches, chickadees, grosbeaks, woodpeckers, titmice and other insect-eating outdoor birds.



Item #	Desc	UPC	Vendor	CS/UOS	Location
82100008	16 oz	719195367811	367816	6/6	National

Songbird Food

A premium wild bird food blended to attract and feed the most desirable outdoor birds. Grosbeaks, finches, cardinals, doves, nuthatches, thrushes, songbirds and other outdoor birds.



Item #	Desc	UPC	Vendor	CS/UOS	Location
82100021	8 lb	719195377087	377080	4/4	National

Special Finch Food

A premium Finch food blended with the seeds that America's favorite Finches love. American goldfinches, purple finches, house finches, chickadees, nuthatches, titmice, and other outdoor birds.



Item #	Desc	UPC	Vendor	CS/UOS	Location
82100032	5 lb	719195381053	381050	6/6	National

Woodpecker Nuthatch N' Chickadee

A premium wild bird food blended to attract and feed the most desirable outdoor birds. Woodpeckers, wild parrots, parakeets, nuthatches, chickadees, jays and other outdoor birds.



Item #	Desc	UPC	Vendor	CS/UOS	Location
82100016	5 lb	719195364056	364050	6/6	National



Cardinal Food

A premium wild bird food blended to attract and feed the most desirable outdoor birds. Cardinals, songbirds, titmice, grosbeaks, thrushes, jays and other outdoor birds.



Item #	Desc	UPC	Vendor	CS/UOS	Location
82100018	7 lb	719195376073	376070	4/4	National
82100019	15 lb	719195376158	376150	1/1	National

Crunch N' Nut Squirrel Food

A special blend of premium ingredients for squirrels and other backyard wildlife. Squirrels, chipmunks, rabbits, raccoons, ducks, geese, elk, moose, antelope and other outdoor wildlife.



Item #	Desc	UPC	Vendor	CS/UOS	Location
82100045	8 lb	719195362083	362080	4/4	National
82100046	20 lb	719195362205	362200	1/1	National

Deck Porch N' Patio

An elite, zero-waste wild bird food blended to attract the most desired outdoor birds and give you the cleanest feeding experience available for your outdoor living areas. Attracts all feeder songbirds, including cardinals, grosbeaks, finches, jays, nuthatches and other outdoor birds.



Item #	Desc	UPC	Vendor	CS/UOS	Location
82100014	5 lb	719195374055	374050	6/6	National
82100015	20 lb	719195374208	374200	1/1	National

Gourmet Outdoor Food

A premium wild bird food blended to attract and feed the most desirable outdoor birds. Buntings, juncos, cardinals, nuthatches, chickadees, finches, jays, titmice, grosbeaks, doves and other outdoor birds.



Item #	Desc	UPC	Vendor	CS/UOS	Location
82100023	8 lb	719195368085	368080	4/4	National

Fruit N' Berry

A premium 5 fruit blend wild bird food blended to attract and feed the most desirable outdoor birds. Songbirds, cardinals, grosbeaks, finches, jays, thrushes, buntings and other outdoor birds.



Item #	Desc	UPC	Vendor	CS/UOS	Location
82100026	5 lb	719195365053	365050	6/6	National
82100027	20 lb	719195365206	365200	1/1	National

Nut N' Berry

Wild Delight's number 1 selling blend! It contains everything a bird can want – Sunflower Kernels, Peanuts, Sunflower Seed, Safflower Seed, Pistachios, Pistachios, Dried Raisins, Dried Cranberries, and of course, all the vitamins, minerals and electrolytes Wild Delight Premium Feeds are known for. Treat your birds to something special!



Item #	Desc	UPC	Vendor	CS/UOS	Location
82100030	5 lb	719195366050	366050	6/6	National
82100031	20 lb	719195366203	366200	1/1	National

Zero Waste Fruit Blend

An elite, zero-waste wild bird food blended with fruit to attract the most desired outdoor birds and give you the cleanest feeding experience.



Item #	Desc	UPC	Vendor	CS/UOS	Location
82100028	5 lb	719195360058	360050	6/6	National

Bugs N' Berries

A premium wild bird food containing our unique three-bug blend and berries. Bluebirds, Grosbeaks, Finches, Titmice and other insect-eating outdoor pets.



Item #	Desc	UPC	Vendor	CS/UOS	Location
82100010	4.5 lb	719195367842	367845	6/6	National

Squirrel Away Food

Bird food formula designed to keep squirrels away, while giving your wild birds the food they will love. Ingredients include Capsaicin, which is derived from hot peppers and acts as a squirrel deterrent.



Item #	Desc	UPC	Vendor	CS/UOS	Location
82100081	5 lb.	719195632550	632550	6/6	National

Zero Waste Food

Better Bird Better Blends contain only the ingredients that desired backyard birds love. This helps to ensure they eat more seed at your feeder instead of tossing it on the ground. You save money by not paying for wasted product. A shell-free blend that attracts the most desirable wild birds while helping to keep yards free of leftover waste



Item #	Desc	UPC	Vendor	CS/UOS	Location
82100082	5 lb.	719195642550	642550	6/6	National

Beautiful Bird Food

Better Bird provides maximum nutrition for a variety of wild birds and caged birds. Each product is uniquely cleaned and virtually dust-free. We use premium ingredients to formulate each blend. Wild bird products are packed in special packaging and provide superior nutrition for all types of Songbirds, Finches and other outdoor pets.



Item #	Desc	UPC	Vendor	CS/UOS	Location
82100005	5 lb.	719195640051	640050	6/6	National
82100006	17 lb.	719195640174	640170	1/1	National

Songbird Food

Bird food formulated to attract a wide assortment of desired songbirds. High energy blend made from premium ingredients designed to provide maximum nutrition for a variety of wild birds.



Item #	Desc	UPC	Vendor	CS/UOS	Location
82100003	5 lb.	719195630052	630050	6/6	National
82100004	17 lb.	719195630175	630170	1/1	National

Finch Food

Finch Wild Bird Food is a better way to feed your birds. It is a blend of Nyjer Seed (Guizotia Abyssinica), Sunflower Kernels, Millet & Canary Grass Seed. It attracts goldfinches, purple finches, house finches, buntings and other outdoor birds.



Item #	Desc	UPC	Vendor	CS/UOS	Location
82100002	4 lb.	719195650043	650040	6/6	National

Nut & Fruit Bird Food

Bird food formulated to attract a wide assortment of desired fruit loving birds including songbirds, woodpeckers, cardinals, finches, titmice, jays, grosbeaks, nuthatches, buntings, and chickadees. High energy blend made from premium ingredients designed to provide maximum nutrition for a variety of wild birds.



Item #	Desc	UPC	Vendor	CS/UOS	Location
82100007	4 lb.	719195656045	656040	6/6	National

Cardinal Bird Food

Features a hearty blend with real nuts and berries. Features added electrolytes for additional health benefits. Specifically designed to attract songbirds including cardinals, grosbeaks, finches, jays and nuthatches.



Item #	Desc	UPC	Vendor	CS/UOS	Location
82100088	4 lb.	719195659046	659040	6/6	National

WORLD SOURCE PARTNERS



Woven Rope Roosting Pockets

These roosting pockets provide cozy roosting and resting places for all small birds. Woven natural grass-rope and natural hangers. Dimensions: A - 6"x6"x9" B - 6"x6"x11" C - 6"x6"x8"

Item #	Desc	UPC	Vendor	CS/UOS	Location
81730396	A Pocket w/ Roof	745487052011	BA05201	25/25	National
81730398	B Acorn w/ Roof	745487052035	BA05203	25/25	National
81730399	C Hive	745487052042	BA05204	25/25	National

SHOW MORE, SELL MORE!

Make it easier for your customers to buy more. Tier benching provides a clean and attractive display and allows you to double your display area.

SAVES WORK, TIME AND MONEY

Enhance Indoor and Outdoor Merchandise

- Benchmaster holds up to 50% more plant material than conventional wood displays
- Creates a clean and professional look

Strong, Durable and Long Lasting

- Molded from tough, high-density, UV stabilized, post consumer recycled plastic
- Will not rot, rust or corrode
- Stains and liquids will not absorb like wood
- Non-porous surface cleans up by hosing it off

Easy Setup and Teardown

- Snap-together design will save time and money
- No tools required
- Change an entire floor plan in minutes

People Friendly

- No splinters, no sharp edges
- Stable and safe to shop and work

Item #	Description
36-2035	2' x 8' BenchMaster Bench
36-2040	3' x 8' BenchMaster Bench
36-2030	16" x 8' BenchMaster Bench
36-2140	1/2 of 36" Round Bench
36-2150	1/2 of 48" Round Bench
36-2160	1/2 of 60" Round Bench

Item #	Description
36-2045	12" Plastic Leg
36-2046	18" Plastic Leg
36-2050	24" Plastic Leg
36-2060	30" Plastic Leg
36-2065	36" Plastic Leg
36-2058	Plastic Collar*

Unlimited configuration & sizes

- Make it any size or shape and move it anywhere
- Season to season, department to department



Caster Bars

*Use plastic collars for stability for multi-tier displays.

Call today to customize your retail display!



KIDS GARDENING



CHECK OUT OUR
CLEARANCE ITEMS!



Griffin Greenhouse Retail WAREHOUSE Shipping Map

We are now shipping nationwide!

NATIONAL



2025

Refer to location key:

National items are stocked nationally
 Select items are sold East or West only; no exceptions

8" Kaleidoscope Planter

Premium plastic modular planter can be displayed individually each planter has a removable saucer ideal for succulents or shallow rooted planted.

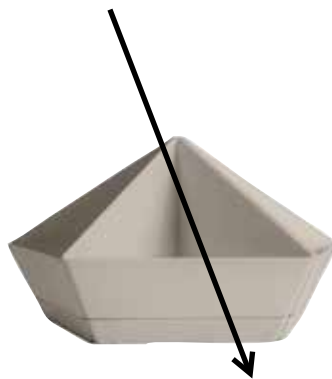

Item #	Desc	UPC	Vendor	CS/UOS	Location
80282643	Vanilla Bisque	770932844170	KDP08000A58	6/6	National

Where is the pricing?

1. Scan QR code on Chapter Pages to see pricing on Griffins.com
2. Contact your Griffin Sales Representative
3. Call into Griffin Customer Service 800.888.0054





FAIRY GARDEN KITS

Easily design a miniature garden scene and step into a world of fantasy. Fairy gardens are miniature gardens complete with structures and living plants limited only by the imagination. These kits include multiple handcrafted pieces and make it easy for children and adults to design unique and delightful gardens.



Charming Forest Fairy Garden Kit contains:

- (1) Owl
- (1) Enchanted Door
- (1) Fairy with Dove
- (1) Welcome Sign
- (3) Wayward Fences
- (1) Vine-Covered Arch
- (3) Stepping Stones

Item #	Desc	UPC	Vendor	CS/UOS	Location
80690703	Charming Forest	849637004759	FG33	12/12	East



Tea Party Fairy Garden Kit contains:

- (1) Tea Pot Cottage
- (1) Fairy with Tea
- (1) Tree Trunk Table
- (2) Tree Trunk Chairs
- (3) Lattice Fences
- (1) Welcome Sign
- (1) Tea Set
- (1) Pair Hedgehogs

Item #	Desc	UPC	Vendor	CS/UOS	Location
80690701	Tea Party	849637004735	FG31	12/12	East



Adoring Acorns Fairy Garden Kit contains:

- (1) Acorn House
- (1) Fairy with Acorn Hat
- (1) Acorn Bench
- (3) Log Fences
- (3) Birdhouse Stakes
- (1) Squirrel
- (1) Tree Slab Pathway

Item #	Desc	UPC	Vendor	CS/UOS	Location
80690702	Adoring Acorns	849637004742	FG32	12/12	East



Face of the Forest Planter

Adding elements of fantasy and wonder to an area is easy with this durable planter for trees, walls, or fences. Whether using the whimsical face-shaped planter as a decorative container for growing and displaying live plants, or as a tree spirit embellishment to enrich the imaginative tone of your outdoor space, this functional planter brings a sprinkle of merriment and a hint of tranquility.

Item #	Desc	UPC	Vendor	CS/UOS	Location
80691011	Willow 8" x 10.5"	849637009402	TF01	4/4	East
80691012	Elderberry 8" x 11.8"	849637009419	TF02	4/4	East
80691013	Hawthorn 7.5" x 11.8"	849637009426	TF03	4/4	East



bloem



Pink Flamingos

Colorful, fade resistant with galvanized steel legs that will not rust. Two classic poses - head up (25"x20") and head down (22"x20"). Features fun googly, moving eyes.

Item #	Desc	UPC	Vendor	CS/UOS	Location
80920770	2 pc.	811214020599	G2	6/6	National

Saturn Planter

Add a touch of modern elegance to your garden or home with this charming Bloem Saturn planter. It is crafted from polypropylene, so it is durable and can be used both inside or outside no matter the weather. The design features natural textures and decorative embellishments to add a beautiful accent to your home.



Item #	Desc	UPC	Vendor	CS/UOS	Location
80922599	5" Fuchsia	087404013348	SP0515	12/12	National
80922602	5" Royal Lilac	087404013379	SP05928	12/12	National
80922603	7" Fuchsia	087404013386	SP0715	12/12	National
80922606	7" Royal Lilac	087404013416	SP07928	12/12	National



Ducky Glove for Kids

This glove is already making a splash. Bright yellow nylon knit with bright orange nitrile 3/4 dip coating. Kids can use it as a puppet, too. Durable, washable, and lots of fun!



Item #	Desc	UPC	Vendor	CS/UOS	Location
80090032	Kids	639751105254	C1052T	12/12	National

Wonder GRIP for Kids!

Textured nitrile palm coating on an ultra-lightweight seamless nylon knitted glove in a size for children. Three assorted colors.



Item #	Desc	UPC	Vendor	CS/UOS	Location
80090215	XS	639751239652	KWG515ACXS	12/12	National

Kid Tuff Too™

These colorful, washable gloves will be instant winners with kids and the adults who like to buy things for them! Nylon knit with textured rubber palm, three assorted characters for each size.



Item #	Desc	UPC	Vendor	CS/UOS	Location
80090214	XS	639751237054	KT440ACXS	12/12	National
80090811	Toddler	639751237108	KT440ACT	12/12	National
80090812	XXS	639751237184	KT440ACXXS	12/12	National



Tub Trugs

The flex buckets are great for carrying needs like job-site tools, landscaping, catering, yard clean up, laundry basket, livestock feeder, trunk organizer, concrete mixing and much more. 3 of each color per case pack. Colors are red, green, blue, and pistachio.



Item #	Desc	UPC	Vendor	CS/UOS	Location
82010656	3.7 gal	721082074047	G404	12/12	National



We collect food waste from our local communities and recycle it into plant food. The Project was developed to provide job skills training and opportunities for individuals with disabilities, as well as repurposing food waste into a usable product.

Item #	Desc	Size	CS/UOS	Location
82190003	5-0-6 All Purpose	2 lb	12/12	East
82190001	4-0-4 Hydrangea	2 lb	12/12	East
82190002	5-0-6 Tomato	2 lb	12/12	East

**Available for sale in CT, MA, ME, NH, NY, RI, NJ, PA, & VT*





Coast of Maine

Bar Harbor Blend™ Premium Potting Soil



Our great all-purpose potting soil is made with natural and organic ingredients such as lobster, kelp, compost, perlite, and sphagnum peat. It is designed for potting indoor and outdoor container plants. Water and fertilize less with this nutrient rich, compost based potting soil. OMRI Listed.



Item #	Desc	UPC	Vendor	CS/UOS	Location
81600011	8 qt.	609853000948	BH4501	200/6	East
81600008	1cf.	609853000481	BH1000	80/8	East
81600007	2cf.	609853000467	BH2000	48/4	East

Indoor Houseplant Mix

Specially formulated for indoor houseplants and flowers using coarse coconut coir, perlite, sphagnum peat moss, and aged bark to optimize drainage and aeration for robust root development. Whether you are growing peace lilies, spider plants, philodendrons, monstera, or other popular or exotic houseplants, this unique compost-free blend provides the optimum structure and benefits for nurturing strong, beautiful indoor plants and flowers.



Item #	Desc	UPC	Vendor	CS/UOS	Location
81600208	8 qt.	609853002096	HP4501	200/6	East
81600209	16 qt.	609853002102	HP4502	120/4	East



Happy Face Tray

6.5" x 5.71"



Item #	Desc	Vendor	CS/UOS	Location
81792560	6 Count Mixed Tray	K90099P-089	6/6	National

Animal Tray

4.13" x 3.74"



Item #	Desc	Vendor	CS/UOS	Location
81792561	12 Count Mixed Tray	K90100P-000	12/12	National

Yellow Duck Planter w/ Drainage Plug

TOD 6.49" | Height 5.91"



Item #	Desc	Vendor	CS/UOS	Location
81792432	Yellow Duck	260083P-005	8/8	National

Cam the Sloth Planter

The cutest plant pot ever. Hand-painted ceramic construction. Comes with a removable drain plug. Perfect for succulents or small flowering plants. Outside size 12.7 cm x 12.7 cm - inner pot diameter 10.8 cm x 10.8 cm - height 11.4 cm



Item #	Desc	Vendor	CS/UOS	Location
81792364	Sloth Planter	260031	6/6	National

CEMENT BUDDIES

Forest animal planters | Adorable addition to any home or garden.



Item #	Desc	Vendor	CS/UOS	Location	Item #	Desc	Vendor	CS/UOS	Location	Item #	Desc	Vendor	CS/UOS	Location
Bird - S: 6.25" x 4" x 4.75" / L: 8.75" x 5.25" x 5.5"					Owl: 4.5" x 4.25" x 4.75" / L: 5.5" x 5" x 6"					Sleeping Cat - S: 7" x 4.75" x 4" / L: 8" x 5.75" x 4.5"				
81791016	Rust - S	9/3411R/1	12/12	National	81791573	Rust - S	260006P-433	12/12	National	81791575	Rust - S	260010P-433	12/12	National
81791017	Nat - S	9/3411/1	12/12	National	81791565	Nat - S	260006P-396	12/12	National	81791567	Nat - S	260010P-396	12/12	National
81791018	Rust - L	9/3412R/1	6/6	National	81791572	Rust - L	260005P-433	8/8	National	81791574	Rust - L	260009P-433	6/6	National
81790079	Nat - L	9/3412/1	6/6	National	81791564	Nat - L	260005P-396	8/8	National	81791566	Nat - L	260009P-396	6/6	National
Elephant - 7" x 5" x 6"					Piglet - S: 6" x 3.75" x 3.5" / L: 7.5" x 4.75" x 4"					Sleeping Dog: 7" x 6.25" x 3.25"				
81791571	Rust	260004P-433	8/8	National	81791578	Rust - S	260014P-433	12/12	National	81791576	Rust - S	260011P-433	6/6	National
81791563	Natural	260004P-396	8/8	National	81791570	Nat - S	260014P-396	12/12	National	81791568	Nat - S	260011P-396	6/6	National
Frog - S: 5.75" x 4.75" x 4" / L: 7.5" x 6" x 5.5"					Rabbit - S: 6" x 4.75" x 3.75" / L: 8" x 6" x 4.5"					Snail - S: 5.75" x 4.5" x 4.25" / L: 8" x 6" x 5.5"				
81791027	Rust - S	9/3431R/1	18/18	National	81791019	Rust - S	9/3441R/1	12/12	National	81791031	Rust - S	9/3471R/1	12/12	National
81791028	Nat - S	9/3431/1	18/18	National	81790089	Nat - S	9/3441/1	12/12	National	81791032	Nat - S	9/3471/1	12/12	National
81791029	Rust - L	9/3432R/1	8/8	National	81791020	Rust - L	9/3442R/1	6/6	National	81791033	Rust - L	9/3472R/1	4/4	National
81791030	Nat - L	9/3432/1	8/8	National	81790088	Nat - L	9/3442/1	6/6	National	81790076	Nat - L	9/3472/1	4/4	National
Hedgehog - S: 5" x 4.25" x 3" / L: 7.75" x 6" x 4.25"					Turtle - S: 6" x 4.75" x 3.5" / L: 7.75" x 6" x 4.5"									
81791021	Rust - S	9/3431R/1	18/18	National										
81791022	Nat - S	9/3431/1	18/18	National										
81791023	Rust - L	9/3432R/1	8/8	National										
81790078	Nat - L	9/3432/1	8/8	National										

All animals have removable drainage plugs!

Kids Garden Tool Set

Kids can work right along side their Parents and experience the thrills of gardening 3pc tools set Shovel, Rake, Hoe in Red.



Item #	Desc	UPC	Vendor	CS/UOS	Location
81380708	3 Piece	038313913014	KD 1001	18/18	National

Kids Wheelbarrow

Kids Poly Wheelbarrow Red Perfect for kids to outdoor yard work.



Item #	Desc	UPC	Vendor	CS/UOS	Location
81380709	Kids Wheelbarrow	038313110024	KD 1002	4/4	National

D&D GARDEN



Kids Tool Display

1 Display box, 15 shovels, 15 rakes, and 6 hoes. Carbon steel head with powder coated. 70CM Light weight steel handle.

Item #	Desc	UPC	Vendor	CS/UOS	Location
82730161	Kids Tool Display	662652731420	5861D	1/1	National



Poly Tools

Durable poly construction. Easy handling and ultra-durable.

Item #	Desc	UPC	Vendor	CS/UOS	Location
82730043	Transplanter	760249614191	2402	12/12	National
82730045	Scoop	760249614214	2404	12/12	National

4" WindyWings™ Mixed Assorted Shelf Display

Each stake is 13" tall. 24 piece mixed assortment in a plastic pot display. Includes (6 each): 4" butterflies, 4" dragonflies, 4" hummingbirds and 4" song birds. Comes fully assembled. Already positioned in a plastic pot. 95% plastic and 10% metal. 6" x 4.5" x 16"



Item #	Desc	UPC	Vendor	CS/UOS	Location
80870001	24pc assortment	093335050352	5035	24/24	National

7" WindyWings Assorted Wind Chimes

The vivid bright hues, the lovely sounds of the soothing chimes through the gentle breeze, and the "springed" wings that add whimsical motion, make this beautiful piece of garden art a delightful decorative accent to any home or yard! Hand painted with a special lacquer coating to protect the colors and provide a high-gloss shine. 4"x 8"x 21".



Item #	Desc	UPC	Vendor	CS/UOS	Location
80870436	24pc assortment	093335401048	40104	24/24	National

HC Leader in Horticultural Containers



Sprite Succulent Pot

Plastic succulent planter has the look of ceramic and concrete without the fragility. Features a drain hole for proper succulent drainage and care.

Item #	Desc	UPC	Vendor	CS/UOS	Location
80282495	2.5" Vanilla Bisque	770932840790	SSP02500A58	20/20	National
80282496	2.5" Artisan Taupe	770932840813	SSP02500E67	20/20	National
80282497	2.5" Faux Concrete	770932840837	SSP02500G28	20/20	National
80282851	2.5" Faux Turquoise	770932844149	SSP02500K22	20/20	National
80282850	2.5" Blush	770932844125	SSP02500K21	20/20	National
80282498	3" Vanilla Bisque	770932840806	SSP03000A58	20/20	National
80282499	3" Artisan Taupe	770932840820	SSP03000E67	20/20	National
80282500	3" Faux Concrete	770932840844	SSP03000G28	20/20	National
80282898	3" Faux Concrete/Copper	770932841360	SSP03000K-20C040LR0Y	40/40	National
80282855	5" Artisan Taupe	770932844026	SSP05000E67	12/12	West
80282858	5" Faux Turquoise	770932844101	SSP05000K22	12/12	West
80282859	7" Vanilla Bisque	770932844057	SSP07000A58	12/12	National



A



B



C

My First™ Bird House w/ Viewing Window (A)

Have more fun with this hands-on learning experience when you build and decorate My First Bird House together! Perfect for workshops, this Kit comes with easy to follow directions, 6 acrylic paints, 2 paintbrushes, coloring sheet, stickers, all wood pieces, and nails. Bird house is 9.75"H x 5.75"W x 6.75"D

Item #	Desc	UPC	Vendor	CS/UOS	Location
82250001	Bird house kit	857505008976	DIY-BIRD	8/8	National

My First™ Wren House (B)

Kit comes with easy to follow directions, 6 acrylic paints, 2 paintbrushes, coloring sheet, stickers, all wood pieces, and nails. Size kit box is 10.04"H x 5.2"W x 2.4" D

Item #	Desc	UPC	Vendor	CS/UOS	Location
82250002	Wren kit	857505008969	DIY-WREN	8/8	National

My First™ Pollinator House (C)

Have more fun with this hands-on learning experiences with your child when you build and decorate My First Pollinator House together! Perfect for pollinator workshops or pollinator week promotions! Kit comes with easy to follow directions, 6 acrylic paints, 2 paintbrushes, coloring sheet, stickers, nails, all wood and bamboo pieces. 10.12"H x 6"W x 2.4"D

Item #	Desc	UPC	Vendor	CS/UOS	Location
82250003	Pollinator kit	857505008983	DIY-BEE	8/8	National



Gnome Watering Can

"Gnute the Gnome" Novelty's gnome watering can stands tall as a sentry over the garden. This 1.5-gallon can is sure to be a classic piece of garden art. 100% recyclable.



Item #	Desc	UPC	Vendor	CS/UOS	Location
80250488	1.5 gal.	026978309013	30901	10/10	National



Babs - Pig Watering Can

Babs, Novelty's affable pig watering can, holds 1¾ gal. of water. Kids and pig lovers alike adore this fine swine watering vessel.

Item #	Desc	UPC	Vendor	CS/UOS	Location
80250029	Pink 1¾ gal.	026978305008	30500	10/10	National

Lucky Duck Watering Can

With a comfortable handle and easy pouring features, this one gallon darling is a winner.

Item #	Desc	UPC	Vendor	CS/UOS	Location
80250486	Yellow 1 gal.	026978301048	30104	6/6	National

Squirt - Fish Watering Can

The fish are flying at Novelty. Making a big splash at the pool, beach or in the garden, Squirt, watering can, appeals to "kids" of all ages. Keeping our earth and waters eco-friendly, Novelty watering cans are recyclable.

Item #	Desc	UPC	Vendor	CS/UOS	Location
80250030	Orange ¾ gal	026978308061	30806	6/6	National



EarthBox® Junior™ Organic Garden Kit

This compact-sized EarthBox® Junior™ is just like the original EarthBox® gardening system, with the same smart technology, but approximately half the size and specifically designed for smaller spaces. EarthBox® Junior™ is the perfect size for growing a kitchen herb garden and is ideal as a pretty window box with flowers.



Item #	Desc	UPC	Vendor	CS/UOS	Location
80250629	JR Green	026978806512	80651	6/6	National
80250630	JR Terra Cotta	026978806550	80655	6/6	National



Coco Critter Planters

Made from genuine coco fiber woven onto a steel frame, these adorable critters make perfect rustic planters, fully lined for safe indoor use.

Item #	Desc	UPC	Vendor	CS/UOS	Location
81621701	Cow		69063	12/12	East
81621699	Pig		69062	12/12	East
81621702	Elephant		69059	12/12	East
81621703	Cat		69071	12/12	East
81621700	Bear		69057	12/12	East



Mini Hanging Animals

3" Mini hanging animals. Hang on the side of your favorite planter! Assorted PDQ displays easily on shelves or counter tops. Ceramic turtle, frog and hedgehog.



Item #	Desc	UPC	Vendor	CS/UOS	Location
81510430	Hanging Asst Animals	038858606662	7898-12-1315	12/12	National



Mini Terracotta Animal Planters

Assorted PDQ displays easily on shelves or counter tops. Terracotta llama, turtle, elephant and hedgehog. Height range: 2½"-3" (elephant & llama heads up to 6"). Opening: 2"-2½".

Item #	Desc	UPC	Vendor	CS/UOS	Location
81510428	Terracotta Asst Planters	038858606624	7896-12-1295	12/12	National



Mini Ceramic Animal Planters

Assorted PDQ displays easily on shelves or counter tops. Ceramic llama, turtle, elephant and hedgehog. Height range: 2½"-3½". Opening: 2"-2½".

Item #	Desc	UPC	Vendor	CS/UOS	Location
81510429	Ceramic Asst Planters	038858606648	7897-12-1305	12/12	National



1 pt. Mini Plastic Watering Can

Kids can easily water plants. Great for indoor plants too. 10"W x 2.75"D x 5.5"H

Item #	Desc	UPC	Vendor	CS/UOS	Location
81550538	1pt. Blue	400278950015	5001B	25/25	National
81552204	1pt. Pink	4027371121246	5001P	25/25	National
81550539	1pt. Green	400278950017	5001G	25/25	National

Kids Watering Can

Kids can water plants like grown ups with these brightly colored watering cans. 16 piece assorted case pack, four of each color: pink, green, blue, and orange. 9"W x 3.5"D x 6"H



Item #	Desc	UPC	Vendor	CS/UOS	Location
81550084	Kids Metal Watering Cans	017783050702	5070	16/16	National

Small Hand Tools

These colorful garden tools are perfect for the youngest gardeners ages 3-10! These tools are great for the garden or sandbox. (36 piece assorted case pack contains 12ea-square, round, and fork hand tools.)



Item #	Desc	UPC	Vendor	CS/UOS	Location
81550823	Square Trowel	692815212856	G340	12/12	National
81550824	Round Trowel	692815212855	G350	12/12	National
81550825	Fork	692815212857	G360	12/12	National
81551163	36-Piece Assorted	017783651039	G330	1/1	National

Kids Pails

Children can easily make sand castles, carry water, and toys. 16 piece assorted case pack, four of each color: pink, green, blue, and orange. 7.25"W x 7.25"D x 6"H



Item #	Desc	UPC	Vendor	CS/UOS	Location
81550085	Kids Metal Pails	017783050801	5080	16/16	National

Little Pals Bug Watching Activity Kit

Embark on a bug-watching journey! The kit contains a tool bag a bug net a bug viewer plastic tweezers a bug catcher binoculars and a comprehensive bug checklist with a pen.



Item #	Desc	UPC	Vendor	CS/UOS	Location
81552576	Activity Kit	813269018293	7-LP730	4/4	National



Little Pals Tool Pouch Kit

Includes green tool pouch, hand trowel, hand fork and children's garden gloves. Gloves have a wide cuff and extra fabric over the knuckles to help protect little hands. Glove design may vary.

Item #	Desc	UPC	Vendor	CS/UOS	Location
81550787	Pink	501355612463	7-LP463	6/6	National
81550785	Blue	501355612441	7-LP441	6/6	National



Elephant Watering Can

Stands about 8" tall, 15" long and holds 2 quarts--the perfect size for your window box flowers or house plants.



Item #	Desc	UPC	Vendor	CS/UOS	Location
81320029	Grey	078304631824	63182	12/12	East

Swan Planter

16" Plastic Blow-Mold Swan Planter with a yellow bill. Has a 6 1/2" x 8 1/2" opening.



Item #	Desc	UPC	Vendor	CS/UOS	Location
81320008	8"	078304518200	51820	12/12	East
81320009	11"	078304518309	51830	12/12	East
81320007	16"	078304516800	51680	6/6	East

Cow Planter

18 1/2" Plastic Blow-Mold Cow Planter with black spots. Has a 5" diameter opening.



Item #	Desc	UPC	Vendor	CS/UOS	Location
81320014	18 1/2"	078304533500	53350	6/6	East

Lamb Planter

18" Plastic Blow-Mold Lamb Planter with pink accents. Has a 5" diameter opening.



Item #	Desc	UPC	Vendor	CS/UOS	Location
81320011	18"	078304516909	51690	6/6	East

Pig Planter

18 1/2" Plastic Blow-Mold Pig Planter. Has a 6" diameter opening.



Item #	Desc	UPC	Vendor	CS/UOS	Location
81320091	18 1/2"	078304533609	53360	6/6	East



Union Featherstone Realmingo

52" original Featherstone feeding flamingo statue. Body is weather & fade-resistant plastic and the leg is painted weather resistant wood.

Item #	Desc	UPC	Vendor	CS/UOS	Location
81320003	Garden Flamingo	078304625656	62565	1/1	East



All planters feature drain holes.



Turtle & Snail Planter

6" Opening, 13" Tall x 9" Wide x 9" Long. Whimsical resin planters in 2 assorted designs

Item #	Desc	UPC	Vendor	CS/UOS	Location
80731316	6" Planters	727744904141	FTS6	4/4	East



Hedgehog, Owl, & Frog Planters

Hedgehog: 5.75" Planter, 7.5" Wide x 11.5" Long x 6.5" Tall
 Owl: 4.25" Planter, 9" Wide x 8" Long x 8.5" Tall
 Frog: 5" Planter, 8.5" Wide x 12" Long x 6.5" Tall

Item #	Desc	UPC	Vendor	CS/UOS	Location
80731309	Animal Planter	727744904165	FHOF5	6/6	East



Colorful Garden Insects

Colorful Garden Insects. 7.5" x 6" x 6"

Item #	Desc	UPC	Vendor	CS/UOS	Location
80731105	Garden Insects	727744280184	DSGI4	16/16	National

Bug Pail Planters

8" Metal Pail Bug Planters in assorted colors with drainage holes 8" x 6" x 6.25"



Item #	Desc	UPC	Vendor	CS/UOS	Location
80730982	8"	727744802737	FBUG8	24/24	East



Butterfly & Dragonfly Pail Planters

10" Butterfly and Dragonfly Pail Planters

Item #	Desc	UPC	Vendor	CS/UOS	Location
80731355	10"	727744904226	FBDPP10	12/12	East



Bug Watering Can Planter

4 colors assorted, no assembly required!

Item #	Desc	UPC	Vendor	CS/UOS	Location
80731303	4.5"	727744904059	FBWC4	24/24	East



KD Watering Can Planters Polka Dot

10" Metal polka dot watering can planters

Item #	Desc	UPC	Vendor	CS/UOS	Location
80731336	10"	727744904028	KDWC10PD	12/12	East



All planters feature drain holes.

Polka Dot Teacup Planters

Bring the whimsical tea time experience to your garden or patio with these planters. Great teacher or Mother's Day gift items. All planters feature drain holes.



Item #	Desc	UPC	Vendor	CS/UOS	Location
80730997	5"	727744802751	FPDTC5	12/12	East



Ceramic Insect Mug Planter

3 assorted styles

Item #	Desc	UPC	Vendor	CS/UOS	Location
80730505	5"	727744801082	FCDMI5	12/12	East



L'il Buggers

100% cotton. Snug-fitting knit wrist.



Item #	Desc	UPC	Vendor	CS/UOS	Location
82290059	XX-Small	065537071466	6165	12/12	East

Baby Baa Baa Mitt

These Watson Gloves XXS Polyester Baby Baa Baa Mitt Cream Cold Weather Gloves are the perfect addition to your baby's winter wardrobe. They are made of ultra-soft polyester for maximum comfort and warmth. Designed to fit snugly around your baby's hands, they are ideal for keeping your little one's hands warm and safe in cold weather. Their vibrant cream color is sure to add a touch of style to any winter outfit.



Item #	Desc	UPC	Vendor	CS/UOS	Location
82290052	XXSMALL	065537904504	9383-XXS	6/6	East

Oh, Snap! (Kids)

15gg WasteNot™ polyester knit made from 23.5% (+/- 2%) recycled post consumer PET bottles. Sandy latex palm coating. Ergonomically formed. Snug-fitting seamless knit wrist.



Item #	Desc	UPC	Vendor	CS/UOS	Location
82290042	XX-Small	065537866277	6171-XXS	6/6	East
82290041	X-Small	065537866284	6171-XS	6/6	East

Spish & Splash (Kids)

6163 Spish & Splash Gloves are the perfect size for your children! At a very small Kids Size XXS these nylon seamless knit gloves have a rubber crinkle latex coating to keep your kids hands safe while they play in the yard with mom and dad. These gloves have a snug fit wrist cuff to prevent dirt and grime from getting into the glove keeping your hands clean.



Item #	Desc	UPC	Vendor	CS/UOS	Location
82290058	X-Small	065537829197	6163	6/6	East

L'il Sprout (Kids)

These Watson Gloves Homegrown XXS Polyester Knit L'il Sprout Green Gardening Gloves are perfect for all your little green fingers. They are lightweight and comfortable, and the snug fit makes them easy to wear while tending your garden. These gloves are made of high quality material, which makes them durable and long-lasting. They will be the perfect companion for your little one's gardening adventures.



Item #	Desc	UPC	Vendor	CS/UOS	Location
82290127	XX-Small	065537866253	6170-XXS	6/6	East



Terms and Conditions

UPS / FED EX

We generally recommend UPS / Fed Ex deliveries as the best method for shipping, providing these requirements can be met: all UPS / Fed Ex shipments require a street address and a zip code. Please do not ask us to ship UPS / Fed Ex unless these requirements are met.

Hazardous materials can not be shipped UPS / FEDEX / USPS

There is a \$26.00 charge per package for all C.O.D deliveries by UPS / Fed Ex. We suggest paying by credit card to alleviate this. UPS / Fed Ex has a fuel surcharge into their freight rates that will fluctuate monthly based on current fuel cost. All orders will have a \$15.00 charge for packaging and handling. There is an additional handling fee of \$25.00 for all packages not in a box or 48 inches along it's longest side, and 30 inches along its second longest side, or has an actual weight of 70 pounds or greater. **Any refused C.O.D deliveries will incur a 25% restocking charge.**

UPS / FED Ex- Damaged Shipments

If you see that a shipment is damaged upon receipt from UPS / Fed Ex, refuse shipment. UPS / Fed Ex will return the shipment to us, and we will file the claim and send a new shipment to you. If after opening the package you find concealed damage, call us at once. We will instruct UPS / Fed Ex to pick up the package and return it to us for a claim. We will reship your order.

C.O.D. Shipment

Will be made to all accounts with a balance over 60 days.

Payments

We accept Cash, Check, or the following major Credit Cards: American Express, Visa, MasterCard, and Discover. No additional discounts allowed on credit card payments. Credit cards taken after the initial purchase will require a signed form stating that purchaser agrees to a 2% processing fee, charged by Griffin Greenhouse Supplies, Inc. and will be charged with the balance being paid.

Offerings

Listed are made subject to being available. We will not be held responsible for delays in shipment caused by conditions beyond our control. Applicable substitutes will be made when necessary.

Terms

Are net 30 days unless otherwise stated. A 1½% per month service charge is added on all overdue accounts. This is an 18% annual charge. Terms are COD where credit has not been established. Returned checks will be assessed a \$20.00 fee. Delayed Payment Plan (dating) will only be extended to accounts with a satisfactory payment record.

Direct Shipment Deposits

All material that is shipped Direct from the manufacturer to the customer will require a 30% deposit before the order can be placed with the manufacturer. Depending on the size or complexity of the order you will be required to sign off on a bill of lading to ensure the accuracy and condition of the order.

Returns

No merchandise may be returned without authorization from our office. Merchandise must be returned within 60 days of purchase. Invoice number and date of purchase is required for any/all returns. A restocking charge of 20% is charged on all returns unless merchandise is defective. **ITEMS THAT ARE SPECIAL ORDERED, MADE TO CUSTOMER SPECIFICATIONS, NON-INVENTORY OR NON-STOCK ITEMS, CANNOT BE RETURNED FOR ANY CREDIT DUE TO THEIR SPECIAL NATURE.**

Chemical Shipping

No chemicals will be left without a customer signature. All restricted use products must be accepted and signed for by the license holder only, which is enforced by state law.

Sales Tax

Appropriate state tax will be charged based on location of delivery. All items will be charged sales tax unless we have your tax exempt number on file. In compliance with the law, we must charge the tax on all items, which the state designates as taxable even though you have provided us with your sales tax number. If any items purchased are for company use please notify us so the appropriate tax can be charged.

Recommendations

Made by us are compiled from recognized horticultural sources. We are not responsible for damage or failure due to recommendations given by Griffin Greenhouse Supplies, Inc.

Notice to Purchaser

The following is made in lieu of all warranties expressed or implied. Seller's and manufacturer's only obligation shall be to replace such quantity of the product proved to be defective. Neither seller nor manufacturer shall be liable for any injury, loss or damage, direct or consequential, arising out of the use or the inability to use the product. Before using, user shall determine the suitability of the product for his intended use, and user assumes all risk and liability whatsoever in connection therewith. The foregoing may not be changed except by an agreement signed by officers of seller and manufacturer. All terms and conditions listed are subject to change.

Motor Freight Shipments

In order to provide you with the best service possible all deliveries made must be signed for, which will ensure the right product and quantities are received. All pallets are wrapped with black wrap and taped to ensure your order arrives complete. If your pallet is tampered with, please sign the bill of lading **"1 pallet received, tape and wrap has been broken."** Any shortages or missed shipments must be noted upon receipt of your delivery, so please try to be available on delivery date.

All orders for delivery must be placed 24 hours, or 2 working days, prior to your delivery day.

The original Bill of Lading attached to our invoice indicates that material shipped has now become your property and is an acknowledgment by the transportation company of the receipt of the property in good condition. Safe delivery of this shipment is now the responsibility of the carrier. Please examine your shipment carefully before signing the freight bill. We will be glad to assist in tracing or recovery of lost merchandise.

Motor Freight - Damage or Shortage

If any damage is noted, or if the number of pieces received does not agree with the number on the bill of lading, **DO NOT** accept the shipment without shortage or damage notated on your freight bill and signed by the carrier's agent (driver). Failure to do so may jeopardize your recovery. If any concealed damage or shortage is discovered when unpacking, leave the material and the packing as is and notify the carrier for a concealed damage or shortage inspection. Consult the carrier for the necessary claim papers and disposition of damaged articles. When checking shipments, compare what was received with packing list or invoice. If there is a shortage or damage, **YOU MUST CONTACT US WITHIN 24 to 48 HOURS** and provide us with full details and pictures.

Claims with motor freight companies must be made promptly. The freight company will not consider a claim unless it is presented within nine months from the date of shipment. The carrier's agent will assist you in making that claim. Claims for loss or damaged material and transportation charges **MUST NOT** be deducted from the invoice and the payment of invoices **MUST NOT** be withheld awaiting adjustment of such claims, since it is the function of the carrier to guarantee safe delivery.

Prices and terms are subject to change without notice.

Prices at time of shipment will prevail. For current quotations, please call us. Prices quoted are FOB Denver, CO; Cheshire, CT; Canton, GA; Tewksbury, MA; Gray, ME; Bridgeton, NJ; Auburn, NY; Brookhaven, NY; Schenectady, NY; Perrysburg, OH; Gresham, OR; Morgantown, PA; Richmond, VA; and Woodridge, IL. or FOB the factory unless otherwise stated.

A

3-1 Garden Spray	230, 233, 239, 241
A & G Agricultural Supply	277-279, 298
Acacia Wood Collection	320
AccelaROOT jump Start.....	19
Acid Loving Plants Mix	37
Acid Special Fertilizer	37, 39, 43, 159, 165, 172, 184
Active Air 3-Way Meter	19
Adjustable Nozzles	120-123, 128, 139-142
Advanced Mix #4	28
African Violet Food	14, 15, 26, 174, 183
African Violet Soil	41, 43, 48, 59
Aglok & Prolock Chain Ties	286
Air Planters	297, 357-358
Alabaster Blend Stone.....	49
Alena Collection.....	316
Alfalfa Meal.....	156, 163, 169
Alice Planter	351
All Natural Plant Food ...	155-161, 166-170, 182, 194
All Natural Plant Hangers	346-349
All Purpose Plant Food... 38,	154-155, 158, 162, 164-165, 171-174, 178, 180-184, 190-192, 247
All Purpose Potting Soil/Mix	38, 45, 46, 51, 56, 60, 61
All Season Lawn Food	71-73, 77-78
All Seasons Spray Oil	233, 248, 262, 272
All Weather Hose.....	148
Aluminum Hand Tools	85-86, 88, 90-91, 99, 103-107
Aluminum Hose Hanger	133, 137, 147
Aluminum Shut Off Valve	125, 131
Aluminum Sulphate	49
Aluminum Water Breaker Nozzle	121
Amer Deer Proofing (Everguard).....	244
American Garden Works	198-199
American Lawn Mower	85
Amturf.....	67
Ana Planter	350
Anchoring Pins	284
Angled Planter.....	338
Animal Planters	309-311, 318, 345, 359, 361, 401-402, 405-407
Animal Repellents	235-236, 242, 244-245, 251, 257, 259, 272-273
Animal Trap	251-254
Annual Bloom Flower Garden Pansy Fertilizer.	162
Annual Grub Beater.....	68
Annual Tree & Shrub.....	231
Ant Bait	230, 270
Ant Control	69, 72, 74-75, 78-79, 230, 234, 239, 241, 249, 250,256, 261
Ant, Flea and Tick Granules	69, 72, 74-75, 78-79, 230-233, 241, 261
Ant, Roach, Spider Control	69, 72, 74-75, 78-79, 234, 241, 255, 256, 262
Ant Moat	380, 383, 387-388
Anti Fatigue Mat	209
Antique Hummingbird Feeder	377, 387-388
Antique Kettle	341, 361
Antiqued Stone Faced Planter.....	367
Anvil Lopper	94
Anvil Pruner	88, 90
Arber.....	153, 227
Arber Bio.....	227
Arber Plant Food	153
Arber Spray Bottle	227
Arc Bowl Planter	314
Arcadia	197-198, 279, 297-298, 373, 399
Ariana Planter	299
Artie Planter	311
Aspen Planter	331
Atlas.....	227
Aurora Roots Soil	18
Auto Mix Hose End Sprayer ...	116-117, 130, 248

Avino Square Planter.....	331
Azalea Fertilizer.....	159, 165, 167, 173, 176, 178-179, 192
Azalea Pot	331
Azalea-tone	167
Azomite Powder	158
Aztec Strawberry Jar.....	361
Azura Series.....	321

B

Babs Pig Watering Can	146, 404
Backpack Sprayer	110, 117
Backyard Nature Products	373-374
Balcony Window Box.....	322, 341-342
Bamboo Gloves	200
Bamboo Self Watering Planter	322
Bamboo Stakes	285
Bamboo Torches	204
Bamboo Trellis Palstic	294
Bar Harbor Blend	36, 401
Barrel Planter	320, 329, 353, 365
Barrier Netting, Deer	281
Basket Hanger	217
Basket Planters	297, 304, 307, 315, 318, 323-324, 332, 345, 351, 354, 368, 370
Bat Guano	156, 172
Bat House/Shelter	383, 385
Bat Magic	236
Battery Powered Sprayer	110
Bear Planter.....	309
Beastie Bloomz	170-171
Bed Bug	234, 239
Bee Barn.....	386
Beetle Bagger Trap.....	238
Beetle Control	68-69, 82, 238
Bee Safe insect killer.....	268

- Bellina Planter 316
 Bembe Nutrients..... 172
 Benchmaster/SPC Retail..... 396
 Bendable Coco Grow Pole 279, 290
 Berry-tone 166
 Better-Gro/Dynamite 13, 35, 154
 Big Bloom 170-171
 Bigload Leaf Rake 89
 BioAdvanced 68-70, 239-241
 Biotics Repot Recovery 58
 Bio-tone Starter 168, 170
 Birch Planter 314, 353
 Bird B Gone 243
 Bird gel 243
 Bird Flash Tape Visual 234
 Bird Spikes 234
 Bird & Pond Netting 282
 Bird Bath Cleaner 271
 Bird Bath Fountain Maintenance 271
 Bird Baths 223, 373, 389, 391
 Bird Cotton Nest Ball 373
 Bird Feeders ..373-376, 381-382, 384, 386, 389
 Bird Food 378-381, 392-395
 Bird Houses373, 375, 383-385, 389-390, 395, 404
 Bird Seed378-379, 392-395
 BirdBlock Mesh..... 281
 Biting Insect Repellent 268
 Black Beauty Grass Seed..... 76-80
 Black Beauty Grass Seed..... 78
 Black Cauldron Planter 361
 Black Gold 27
 Bloem 115-116, 202, 298-303, 399
 Blood Meal 157, 163, 168, 175, 182
 Bloom Nutrient 154-155, 158-160, 162-165, 169-171, 173-174, 176, 178-179, 181-184, 186, 190-193
 Bloom! 1-3-1 169
 Blossom Booster 184
 Blossom Set 237
 Bluebird House 384-385, 389
 Bobbex 243
 Boho Pot 305
 Bond 204
 Bone Meal 154, 156, 161, 163, 167-168, 172, 175, 182
 Bonide 14, 68, 116, 153, 227-238
 Bon-Neem 233
 Bonsai Mix/Soil 41, 49, 57
 Bonsai Shears 18, 19
 Bonsai Fertilizer 177
 Bontone 14
 Boomerang..... 170, 172
 Boost 21
 Border Cylinder, Clay 326
 Bosmere 13, 85, 116, 203-204, 280, 400
 Boss Glove (Westchester)..... 222-223
 Bow Rake 87, 89, 97
 Bow Saw 92
 Bowl Planter 297, 300, 303, 306, 312, 315, 317-319, 332, 338
 Brass Hose Swivel..... 121
 Brass Nozzle 121, 126, 128, 140
 Brass Quick Connectors 121, 125-126, 129-131, 145
 Brass Shut Off Valve 115, 130-131
 Braun..... 303-307
 Breaker Nozzles 121
 Brentwood Planter 351
 British Meadow 118
 Broadleaf Weed Control 68, 70, 73-75, 81, 227, 250, 264, 265
 Brome 374-375
 Bromeliad Food 13, 180
 Broom..... 96
 Brush Killer 70, 81, 228, 240, 241, 249, 264
 Bubbler Sprinkler 133
 Bug & Slug Killer 232, 249, 251
 Bug Buster 251, 260, 262
 Bug Mugs Planter..... 367, 408
 Bugs For Birds..... 380, 394
 Bug Pail Planters..... 407
 Bulb Food 38, 156-157, 160, 163, 167-168, 174-175
 Bulb Pan..... 298
 Bulb Planter..... 105
 Bulb-tone 167
 Bulk Coco Liner 343, 370
 Bulk Hardwood Stakes 279, 286
 Bulk Landscape Fabric Pins 283
 Bulk Coco Liner 343, 370
 Bulk Peat Pellets 22, 25
 Bulk Spikes..... 185
 Bulk Steel Stakes 285, 292
 Burlap 286
 Bush Doctor..... 172
 Bust Planter 307
 Butterfly Clips 62
 Butterfly Feeder..... 374
 Butterfly Nectar..... 374, 390-391
 Butterfly Plant Stakes 215
 Bypass Lopper..... 88, 94, 98-99
 Bypass Pruner..... 88, 90-91, 99, 103-107
- C**
- Cache Pots 318, 338
 Cactus Food 14, 15, 154, 160, 164, 174, 192
 Cactus Mix/Soil..... 37, 38, 43, 44, 48, 52, 57, 60
 Cado-Union 150, 220, 361
 Cage, Suet 376, 381-382, 386

- Cages, Tomato 292, 319
- Cakes, Suet..... 380-381, 393
- Calcium Supplement 21, 154-157, 159, 161, 166, 168, 175, 177, 180, 189
- Cape Cod Challenger 155, 400
- Capello Planter 315
- Capri Bowl 332
- Captain Jack Deadweed Brew 228
- Captain Jack Lawnweed Brew 228
- Captain Jack's Deadbug Brew 153, 231, 289
- Captain Jack's Neem-Max 153, 289
- Caribbean Pot 332
- Carpenter Ant Control..... 241, 270
- Carpenter Bee Killer 241
- Carpet Saver Saucer..... 308-309, 329
- Cast Iron Plant Caddy 323
- Castine Blend Raised Bed 36
- Catch & release Humane Trap 254
- Cat Repellent..... 246, 259
- Caterpillar Killer 153, 231
- Ceiling Hook 218
- Cement Buddies 310, 402
- Cement Heart Planter 312
- Cement Pots 307, 309-314, 318, 367
- Cemetery Vase Planters 341
- Centurion 86-88, 375-377
- Ceramic Planters 305, 311-312, 321, 328, 338, 359, 367, 369, 408
- Ceramic Tea Cup Planter 367, 408
- Cha Ching 171
- Chapin 71, 117
- Charcoal 43, 49, 52
- Chemically Resistant Sprayer 111-112, 117
- Chicken Manure 162, 182
- Chickweed Killer 81, 228
- Chipmunk Repellent 235
- Christmas Planters 314, 316
- Christmas Tree Watering Aid..... 165
- Citrus FeED 184
- Citrus Fertilizer 159, 162, 167, 172-174, 177-178, 184, 186
- Citrus Food ... 159, 162, 167, 172-174, 177-178, 184, 186
- Citrus Leafminer Trap 266
- Citrus-tone 169
- CJ NeemMAX RTU 289
- Classic Home & Garden.. 204-205, 280, 309-320, 401-402
- Classic Urn 340
- ClassiCote Fertilizer 183
- Clay 326-327, 353
- Clay Pebbles 18
- Clear Dome 19, 25
- Clear Saucers (Vinyl) 308
- Cleaning Brush 383
- Cleopatra Bust..... 307
- Clinch Couplers 144
- Clonex 16
- Clover Control 70, 81, 228
- Coast of Maine 15, 35-37, 154-155, 401
- Coated Paper Tree Wrap..... 206, 286
- Cobstock Blend Garden Soil 36, 42
- Coco Critters 345, 405
- Coco Fiber Liner 297, 323-324, 345, 370
- Coco Loco Potting Mix..... 46
- Coco Moss Liners..... 297, 343, 370
- Coco Moss Planters .. 297, 323-324, 343, 345, 370
- Coco Peat Buff Mini Bale 62
- Cocoa Shell Mulch..... 46
- Coconut Coir 18, 24, 25
- Coffee Cup 356
- Coir Blocks/Bricks 18, 25
- Coir, Bagged 18, 59
- Cool Power Herbicide..... 267
- Colander Planter..... 368
- Colchester Planter 311
- Coles 378-380
- Colorado Beetle Killer 232
- Combo Pruning Set 104
- Compact Pruners 105-106
- Compact Shears..... 105-106
- Complete Disease Control 263
- Complete Grow Light Systems 18, 24, 28-30
- Compost Aerator 108
- Compost Blend 35, 36, 37, 42, 61
- Compost Starter 163, 169
- Compost Tea Bags 194
- Compost Thermometer..... 187
- Composted Cow Manure 37, 44
- Compound Action Hedge Shears 98
- Compound Action Tree Pruner 92
- Cone Planter 304, 345, 354, 369
- Connecting Stakes 289
- Contractor Hose 148
- Coop Poop 182
- Copper Fungicide 237, 247
- Copper Plant Label 23, 203
- Copper Stopper Slug Snail Tape 252
- Corinthian Planter 315
- Cork Mat Saucer..... 309
- Cork Saucer..... 309
- Core Aerator 108
- Corn Gluten 258
- Corn on the Cob 392
- Corona..... 89-103, 118, 321, 403
- Cottonseed Meal 156, 176
- Countryside Planter 340-341
- Cow Manure 49

- Cow Planter 309, 343, 345, 361, 406
 Crab Meal 190
 Crab Shell 190
 Crabgrass & Weed Preventer .. 68, 70, 182, 227
 Crabgrass Control 68, 70, 182, 227
 Cracked Corn 379
 Crawling Insect Control ..69, 72, 74-75, 78-79, 244, 250, 251, 254
 Culti-Hoe..... 87, 91, 92, 104
 Cultivation Nation Fertilizers..... 171
 Cultivation Nation Growing Mix 46
 Cultivator 86, 87, 91, 92, 96, 102, 104, 105
 Curio Planter 333
 Curtis Wagner 308-309
 Cushion Grip Tools 90-94, 96, 98
 Cut-N-Hold Pruner..... 101
- D**
- D&D Garden 103-105, 285, 403
 Daconil 238
 Dakota Trough 313
 Dalen 71, 165, 206, 245, 280-282
 Dark Harbor Blend Org. Mulch 36
 DCN 321-323
 Deck Hanger..... 212, 214
 Deck Railing Bracket 216, 217, 322
 Deck Railing Planters 302, 314, 320, 322
 Deco Faceted Bowl 338
 Decorated Pumpkin 220
 Decorative Glass Gems 39, 41, 53
 Decorative Moss Baskets 304, 354-356
 Decorative Plant Stakes 199, 204, 215
 Decorative Sand 50, 54, 62
 Decorative Stones 40, 49, 53, 54, 59
 Decorative Trellis 197, 199, 277, 278, 280, 290, 291
 Decorative Watering Cans..... 116, 118, 146, 149-150, 407
 Deep Root Irrigator 104
 Deep Saucers..... 308
 Deer Ban 272
 Deer Netting 281
 Deer Park Ironworks 206-208, 323-325
 Deer Repellent..... 235, 243, 245, 259
 Deer Scram 246
 Dehydrated Cow Manure..... 50
 Deluxe Pedestal Urn..... 298
 Dense Shade Grass Seed..... 76
 Deroma 326-328
 Desert Sand 50, 54
 Devault 329
 Devoncourt Planter..... 319
 Dew Right Water Bag 116
 Dewitt 106, 118, 208, 282-285
 Dial Nozzles..... 117-118, 120, 123, 128
 Diatomaceous Earth 231, 248, 257, 273
 Digging Bar..... 101
 Digging Fork 88, 92, 96
 Digital Heat Mat Controller 17
 Digital Moisture Meter 19
 Dipel Dust..... 248
 Dirt Pot..... 17
 Disease Control ..68-69, 73, 78, 80-81, 241, 263
 Disease Control, Lawns..... 68
 Disease Control, Nat & Organ ..237, 238, 242, 244
 Disease Control, Roses 240, 241, 242
 Dish Garden 303, 305-306, 315, 317, 319, 332-333, 338, 343, 355-356
 Distinction Planters 322
 Distressed Oak Keg Planter 320, 353
 Dog Repellent 246, 259
 Doherty Pots..... 314
 Dome 19, 22, 25, 28
 Dorado Planter 318
 Dotted Ceramix Planters 312
 Double Peony Ring..... 289, 292
 Double Thick 1020 Tray..... 29
 Down to Earth..... 155-161
 Down Under Plant Caddie 203, 204
 Dr. Earth 38-39, 162-165, 244
 Dr. Iron 266
 Dragonfly Pot..... 297, 367, 369
 Drain Spade 83, 88, 93
 Damm 15, 105-106, 118-126
 Dried Blood.... 157, 163, 168, 175-176, 178, 182
 Dried Mealworms 380, 393
 Drippy Caterpillar..... 219
 Drop Forged Pruner set..... 104
 Duck Planter 309
 Dura Cotta Planter..... 300
 Dust, Disease Control 237-238, 250
 Dust, Insect Control..... 153, 248, 273
 Dutch Kettle Planter 341, 361
 Dynamite/Better Gro 13, 154
- E**
- Earthbox 342
 Earth Edge 208-209
 Earthshine Biochar 47
 Earthworm Castings.. 36, 41, 47, 60, 154, 181-182
 Easel Stand 215
 Eaton 165, 209, 286
 Eclipse Planter..... 331
 Eco Pond Clear 179
 Edger 93
 Edging 208, 284, 292
 Eight 231, 233

- Electronic Mister 145
 Electronic Soil Tester 188
 Electronic Timer ..117, 119, 135, 137, 142-143, 257
 Elephant Planter 310, 345, 402, 405
 Elephant Watering Can 150, 406
 Ella Planters 339
 Elle Planter 314
 Epic..... 245
 Epsom Salts 21, 262
 Espoma15, 41-43, 71-72, 166-170
 Espalier Trellis 277
 Essential Vase..... 357
 Evergreen Spikes 185
 Evergreen Tone 166
 Everguard 244
 Exhart 209-211, 403
 Exotic Pebbles..... 39-41
 Extendable Handle Tools..... 92, 98, 101
 Extended Control Weed Preventer 71, 73, 79
 Extended Feed Fertilizer 174, 176, 183
 Extender Chain..... 216
 Extender Hook 216,217
- F**
- Fabric Pegs/Pins/Staples 280, 284
 Fabric Planters 17, 26, 27
 Face of the Forest Planter 197, 399
 Fafard 61
 Fairy Garden Kit 197, 390
 Fall Fertilizer 71, 77-78
 Falmouth Planter 314
 Fan Spray Nozzle 123, 142
 Fan Trellis 199, 277, 291
 Fast Grow Grass Seed Mixture 79
 Faucet Adapter 132-133, 137, 143-144
 Feather Meal 157, 194
 FeED 20, 183-184
 Felco..... 106-107
 Fertilizer Plus Weed Control 70, 75, 77, 82
 Fertilizer Spikes 22, 23
 Fertilizer, Iron..... 153-154, 166, 175, 177, 186, 189, 191
 Fertilizer, Lawn 70-72, 80
 Fertilome.....16, 43-45, 72-74, 107, 173-175, 246-249
 Fibered Sphagnum Moss 53
 Fiberglass Handled Tools 85, 89, 93, 100
 Fiberglass Stake..... 285
 Filter Washers 121, 135, 145
 Filter Inline Hose 143
 Finch Feeders 373, 389
 Finger Snips 93
 Finisher 191
 Finley planter 302
 Fir Bark 40
 Fire ant 69
 Fire Hose Nozzle 251
 Fish & Guano Fertilizer 261
 Fish Bone Meal 154, 156, 163
 Fish Fertilizer 154, 156-158, 160, 163, 172, 174, 190
 Fish Watering Can 146, 404
 Fish-Seaweed Blend 190
 Flag Pole 212
 Flags..... 212
 Flair Planter 318
 Flaming Squirrel Seed Sauce..... 380
 Flamingos 202, 220, 399, 407
 Flat Hose 145
 Flea Control 72, 75, 79, 234
 Flex Rake 85
 Flora Trio Planter 313
 Floral Clipper 90, 91, 103
 Florel Brand Growth Regulator..... 264
 Flower Booster 164, 167, 169-170, 173, 178-179, 183-184, 190, 193
 Flower Box Liners..... 340, 343
 Flower Cart..... 208
 Flower Support/Prop 289
 Flowering Plant Food Spikes 22, 23
 Flowers & Veggie Fertilizer ... 154, 158-159, 168
 Flower-tone 167
 Fly Control 72, 238
 Fly Trap 238, 266, 269, 270
 Flying Insect Control 72, 238
 Folding Kneeler Seat..... 203
 Folding Saw 89, 101, 103, 106
 Forest Moss..... 55, 62, 64
 Forged Garden Hooks 198
 Forged Tools..... 88, 90, 98, 99, 101, 104
 Formula 707 Soil 18
 Fountain Clarifier & Algacide 271
 Fountains 205
 Fox Farm 16, 45-46, 170-172
 Frey Group 35
 Frost Blanket 282
 Frosty the snowman planter 314
 Fruit & Nut Orchard Spray 229
 Fruit & Veggie Disease Control.. 239
 Fruit & Veggie Insect Control 239
 Fruit & Veggie Planting Mix 48
 Fruit Feeder 382
 Fruit Fertilizer..... 39
 Fruit Fly Trap 269
 Fruit Picker 101
 Fruit Tree & Plant Guard..... 229
 Fruit Tree Spikes 185
 Fruit Tree Spray 229, 248, 261

- Fundy Blend Organic Mulch 35
 Fungicide 68-69, 73, 80, 244, 247, 262
 Fungonil 238
 Fungus Control, Lawns 68-69, 80
 Futura Planter 322
- G**
- Galvanized Planters 303, 306, 313, 325, 343-344, 362-369
 Galvanized Watering Cans ... 118, 147, 149-150
 Garden Compost 35-37, 42, 61
 Garden Food 153-194
 Garden Fork 88, 92, 96
 Garden Fungicide 238, 244, 247, 262
 Garden Gypsum 43, 48
 Garden Hoe 87, 92, 102
 Garden Hook 21, 347
 Garden Insect Spray 47, 239, 240, 244, 248, 250, 254, 260
 Garden Kneeler 105, 203, 204, 208-209
 Garden Lime 39, 43, 50
 Garden Manure Blend 37, 61
 GradenMAX-SOIL Treatment 48
 Garden Mix/Soil 36, 56
 Garden Netting 280, 281, 282, 288, 293
 Garden Soil/Mix 35, 36, 44, 52
 Garden Spade 93
 Garden Staples 280
 Garden Statue 211
 Garden Tidy 203
 Garden Twine 280, 287, 288
 Garden Weed Preventer 268-269
 Garden Wire 287, 288
 Garden-tone 166
 Garman Commodities 46
 Gathering Rings 289
 Geolite 18
 Geometric Ceramix Planters 312
 Germination Blanket 282
 Germination Station 17, 19, 30
 Gilmour 127-135
 Glass Gems 39, 41, 53
 Glass Plant Mister 149
 Glass Terrarium 357-358
 Gloves 199-202, 220-223
 Glyphosate 249, 264
 Gnome Statues 211
 Gnome Watering Cans 146, 404
 Go Away Repellent 235, 236
 Gonzo 252-254
 Good Earth (Hoffman) 17, 48-50
 Gopher Getter Nidget 273, 274
 Gopher Getter Applicator w/Bait 274
 Gopher Repellent 273
 Gopher Killer 236
 Gopher Shield 253
 Gopher Trap 252
 Grafting Wax 165
 Grass Fast Natural Roll 78
 Grass Killer 69-70, 74, 81
 Grass Seed 67, 76-82
 Grass Seed, West 76
 Grass Shear 91
 Grassy Weed Control ... 69-70, 74, 81, 264, 265
 Grecian Urn 302-303, 361
 Green Aminos 47
 Green As it Gets 47
 Green Gro Biologicals 47-48, 252
 Green Gro Water Filter 47
 Green Grower Pot 331
 Greenhouse Dome 19, 22, 25, 28
 Greenhouse Grower Kit 17, 19, 21, 25, 26
 Greenhouse, Mini 17, 19, 25, 26
 GreenView 181
 Greenwich Urn 316
 Grid Support Ring 289
 Gro Triangle 294
 Gro-Dome 17, 19, 22, 25, 28
 Ground Bee Killer 234
 Ground Hog Repellent 227, 242
 Grow Bags 17, 26, 27
 Grow Big 16, 170
 Grow Bulbs 29
 Grow More 177-181
 Grow Pole 279, 290, 345
 Grow Through Grids 280, 289
 Grow!T Coco Coir 18, 24
 Growers Basics Pot 331
 Growers Blend 15
 Growers Mix 15
 Growing Lights 18, 24, 28-30
 Growers Wall Nasket 16" 215
 Grub Beater 68
 Grub Control 68-69, 75, 79, 82
 Gypsum 43, 48, 155, 161, 175
- H**
- Half Bucket Planter 343
 Hand Leaf Grabs 82
 Hand Saw 89, 92, 101, 103, 106
 Hand Seeder 71, 78
 Hand Sprayer 86, 110-112, 117, 136
 Hand Spreader 71, 78
 Hand Tools 86, 91, 104, 105
 Hang Loose Planter 356
 Hanger (Rod) .. 198, 204, 207, 212-214, 216, 389

- Hanging Animals Plant Pals 359, 405
 Hanging Basket Chain 216
 Hanging Basket Drip Pan 308
 Hanging Basket Fertilizer Spikes 23, 193
 Hanging Basket Water Wand 119, 123
 Hanging Baskets 198, 297, 304, 307, 315, 317-319, 323-324, 332, 339, 345, 349, 351, 354, 368, 369-370
 Hanging Bowl 339
 Hanging Solar Lights 223
 Hanging Terrarium 348, 358
 Happy Face Planter 318, 401
 Happy Frog 45, 171-172
 Hardwood Stakes 279, 285, 286
 Harmony Planters 322
 Harris 48, 136, 181, 255-257
 Harvest Guard 206, 280, 281
 Haverhill Planter 317
 HC Companies 136, 309-320, 330-338, 403
 HDI 16
 HDR Wine Barrel 353
 Head Planters 307, 367
 Healthy Grow 182
 Heat Mat 17
 Heat Mat Controller 17
 Heath 212, 380-383
 Heavy Traffic Grass Seed 76-77
 Hedge hog Owl & Frog Planter set 368, 407
 Hedge Shears 88, 94, 98
 Herb Carrier 343
 Herb Planter .. 267, 331, 333, 338, 342-344, 361
 Herbicide Granules 250
 Herbicide Helper 265
 Hi-Flo 4 Way Hose Valve 146
 High Caliper Growing (Smart Pot) 26-27
 High Rise Sprinkler 133
 Hi-Yield 74-75, 175-177, 250-252
 Hobby Greenhouse 31
 Hoe 85, 87, 91, 92, 96, 101, 102
 Hoffman-Good Earth 17, 48-50, 182
 Holly-Tone 167
 Holographic Scare Tape 206
 Holster, Pruner 91, 103
 Home Insect Control .. 69, 72, 74-75, 78-79, 234, 239, 242, 244, 256
 Honeycomb Planter 306, 366
 Honeysuckle Planter 316
 Hookery 212-214
 Hooks/Hangers 212-214, 303, 347
 Hori Hori Garden Knife 94
 Hornet Killer 230, 234
 Horticultural Charcoal 41, 43, 49, 52, 181
 Horticultural Lime 43, 50
 Horticultural Oil 233, 247, 261-262, 272
 Hose 125, 132-133, 145
 Hose Connector 121, 129-130, 133, 144-145
 Hose End Sprayer 116-117, 130
 Hose Guide 121
 Hose Hanger 133, 137, 147
 Hose Menders 129-130, 144-145
 Hose Truck 137
 Hose Wall Mount 137
 Hose Washers 121, 135, 145
 Hose, Soaker 125, 132
 Hot Meats 378, 380
 Hot Pepper Wax (Repellent) 235
 House, Bat 383, 385
 House, Bird 373, 375, 383-385, 389-390, 395
 Household Insect Control 14, 234, 239, 242
 Household Shears 103
 Houseplant Food.. 13, 14, 15, 26, 160, 164, 174, 177, 180-181, 183, 192-193
 Houseplant Food Spikes 22, 23
 Houseplant Insect Control 14, 239, 242, 256
 Houseplant Special 57, 183
 Hula-Ho Weeder 85
 Humic Acid, Granular 157
 Humidity Dome 19, 22, 25, 28
 Hummer's Galore 383
 Hummingbird Feeders .. 377, 380, 383, 387, 388
 Hummingbird Nectar 374, 383, 387-388
 Hydrangea Blue 155, 159, 165-167, 176, 178-179, 184
 Hydrangea Food 155, 159, 165-167, 176
 Hydrated Lime 177
 Hydro FeED 19, 20
 Hydro Trio Pack 171
 Hydrofarm 17-19, 257
 Hydrogen Peroxide 12% 256
 Hydrolyzed Fish 157, 160, 190
 Hydroponic Calcium Nitrate 21, 175
 Hydroponic Micro Snip 15, 18, 19, 86
 Hydroponic Nutrients 16, 155, 170-171, 185
 Hydroponic Soil 15
- I**
- Impulse Sprinkler 124-125, 134
 In Pot Cane Support 294
 Indoor Insect Killer 14, 153, 231, 289
 Indoor Houseplant Mix 37, 401
 Indoor Light Systems 18, 24, 29, 30
 Indoor Plant Food 14, 15, 160, 164, 169, 174-175, 178, 180, 183-184, 190, 192
 Indoor Plant Tray 13, 22
 Indoor Watering Can 115-116, 118, 126, 136, 146, 149-150, 404, 405
 Inflatable Snake 206
 Infuse 68, 238

Insect & Grub Control 69, 72, 74-75, 78-79
 Insect Control .. 14, 68-69, 72, 74-75, 78-79, 82, 232, 248, 262 265
 Insect Control Dust..... 233, 234
 Insect Control Granules..... 14, 74-75
 Insect Control, Lawns 69, 72, 74-75, 78-79
 Insect Control, Organic 14, 79, 227, 268
 Insect Repellent..... 245
 Insecticidal Soap 14, 233, 242, 260
 Instant Green Mat 62
 Insulated Nozzle 127, 140
 Iron Supplement .. 153, 166, 175, 184, 186, 189, 191, 267
 Iron-tone 166

J

Jack O'Lantern Pot..... 331
 Jack's Classic 183-184
 Jack's Nutrients 20, 183-184
 Jackson Pottery..... 338
 Jake Planter..... 313
 Jameson Rail Planter 320
 Japanese Beetle Killer 231
 Japanese Beetle Trap 238, 269
 Jiffy 21-22, 80, 185
 Jiffy-Pots 21-22
 Jobe's 22, 185
 Jonathan Green 76-80
 JRM Chemical 193
 Jumbo Bedding Plant Tray 103
 Jumbo Ceiling Hook 218, 347
 Jumbo Fly Catchers 238
 Jump Start Light 18, 24, 28, 30
 Junior Garden Kit, Earthbox 404
 Jute Twine 281, 284
 Jute Twine 286

K

Kaleidoscope Planter 333
 Kangaroots 170, 172
 Kay Planter 352
 Kelp Me Kelp You 172
 Kelp Meal .. 154, 160, 163, 168, 171-172, 180, 190
 Kiawah Planter 311
 Kid's Activity Kit 220, 404, 406
 Kid's Gloves 199, 201 221, 222, 400, 408
 Kids Tools 95, 103, 112, 149, 403, 405, 406
 Kids Pails..... 149, 405
 Kids Watering Cans..... 149, 405
 Kids Wheelbarrow 95, 403
 Killzall 74, 250
 King Cup Planter 305
 King Mix..... 57
 Kink Protector..... 132
 Kleen Up..... 227, 228
 Kneeling Pads 105, 208, 209
 Knox Fertilizer (Schultz) 192
 Koekedama Sphagnum Basket..... 356

L

Labels..... 23, 24, 203, 288
 Lacis Trellis Planter 354
 Ladder Trellis 278, 280, 291
 Lamb Planter..... 361, 406
 Lambert 24, 51-52
 Land & Sea Compost 42
 Landscape Fabric 283, 286
 Landscape Rake..... 89
 Langbeinite..... 156
 Lantern Planter..... 343
 Large Mouth Fish Planter 311
 Lava Rock 49
 Lavendar Garden Planter 68, 306

Lawn Booster..... 71, 80
 Lawn Disease Control .. 68-69, 73, 80-81, 242
 Lawn Edging 208, 284
 Lawn Food 71-73, 77-78
 Lawn Food, Natural 71-72
 Lawn Fungicide 68-69, 73, 80, 244, 247, 262
 Lawn Insect Control 69, 72, 74-75, 78, 82
 Lawn Moss Control..... 68-69, 81-82
 Lawn Repair 67, 71, 76-80
 Lawn Restore 67-68, 71-72, 76-80
 Lawn Seed Starter 67, 71-72, 76-80, 267
 Lawn Soil 35, 37
 Lawn Weed Killer 68-70, 73-75, 77, 80-82, 252, 258
 Leaf Compost 35
 Leaf Rake 85, 86, 89, 97, 109
 Leaf Scoop 85
 Leaf Shine 14, 193
 Leather Holster 107
 Lebanon..... 80
 Leca Balls..... 59
 LED Light..... 24, 28, 29
 Level Head Rake 89, 97
 Lewis Tools 108-109, 137
 License Plate Planters..... 313
 Lichen Parmelia Natural Grey 64
 Light Kits..... 18, 24, 29, 30
 Light Meter..... 188
 Light Warrior Potting Soil 46
 Lighted Pumpkin..... 220
 Lightning Lime 72
 Lime..... 72
 Link-ups 289
 Liquid Copper Fungicide 247, 261, 263
 Liquid Iron Complex 153, 175
 Liquid Kelp 160, 172, 180

Liquid Plant Food	14, 15, 16, 26	Microfiber Cloth	218	Mosquito Bits	272, 273
Liquid Plant Shine	14	Microbe Plant Food	172	Mosquito Control	72, 230, 234, 245, 265, 272
Liquid Squid Food	155	Micro-Pruner	15, 19	Mosquito Dunks	272
Liquinox	186-187	Milk Can Planters	343, 325	Mosquito Repellent.....	72
Lobster Compost	36	Milky Spore	82, 273	Moss	62-64
Lobster Meal	154, 190	Milorgonite	81	Moss Bird Houses	356, 390
Long Handle Tools	85-87	Mini D Handle Shovel	86, 87, 88, 92, 93, 105	Moss Control	68-69, 80-82
Loop Stakes	289	Mini Greenhouse (4 Tier & 5 Tier)	31	Moss Max	68
Loppers.....	88, 94, 98, 99	Mini Greenhouse Kit T5HO	29	Moss Planters	354-356
Lucky Bamboo.....	177	Mini Measure Shot Glass	19	Moss Pole.....	291, 293
Lucky Duck Watering Can	146, 404	Mini Planter Pot	297, 305, 309-314, 321, 327-328, 332, 338, 348, 359	Moss Stake.....	293
Luster Leaf	23, 187-189, 214, 258, 287-289	Mini Sphagnum Bale	53, 62	Moss Purse Set	355

M

Machete.....	101	Miramonte Basket Set	355	Moss, Sheet	62, 63
Macrame.....	346-349	Mister.....	118, 148-149	Mosser Lee	24, 53-54, 291
Mag-I-Cal Calcium Fertilizer	78	Mite Control	14, 241, 242, 260, 265	Mossify	24, 55, 109, 145, 290-291
Magnesium Sulfate.....	21, 176	Mite-X	14	Moth Trap	238, 266
Malathion	232, 250	Modular Light System	30	Motion Sensor Light.....	223
Malibu Compost	53	Mohegan Blend Black Earth.....	37	Mount Desert Island Cactus Mix.....	37
Manure	36, 49-50, 61	Moisture Control Potting Mix	41, 51, 60	Mouse Magic	236
Manure Fork.....	96	Moisture Meter	19, 30, 187-188 258	Mouse Trap.....	252, 255
Marine Cuisine	171	Moisture Storing Crystals	28	Mulches	35, 36
Mark It Blue	263	Moka Terra Cotta	347	Multi-Function Sharpener	91
Mater Magic.....	154	Mole Control	73, 235, 252, 254, 273	Mushroom Compost.....	35, 42
Mathers planter.....	300	Mole Killer.....	236		
Mattock	103	Mole Max	235	N	
Maxwell Planter	311	Mole Max Sonic Spike	236, 252	N Sulate	285
Mealworms	380, 393	Mole Scram	236	Nano Dome	28
Measuring Cup	19, 189, 252	Mole Trap.....	252, 254	Nantucket Planter	317
Mechanical Water Timer	117, 119, 135, 142-143	Moletox	236	Natria	81, 242
Melnor.....	137-145	Monterey	80, 109, 189, 259-267	Natural Burlap.....	282, 286
Messinas	81, 258-259	Monterey Magnify	265	Natural Jute Twine.....	286
Metal Planters.....	303, 306, 313, 325, 343-344, 362-369	Moose Planter	309	Natural Pebbles	54
Metal Watering Cans	118, 147, 149-150	Moroccan Bowl	319	Natural Plant Hangers	346-349
		Mosquito Beater	230, 234- 259-267	Natural Stone Collection.....	40
				Nature's Source	189

- Nature's Way 384-388, 404
 Nectar 374, 383, 390-391
 Neeleez Kneeler 204
 Neem 153, 233, 234, 242, 249, 256, 262
 Neem Seed Meal 158
 Nematode Control 269
 Neptune's Harvest 190, 267
 Netting 280, 281
 Never Dry Plant Pal 148-149
 Nitrile Coated Gloves 199, 200, 201, 202
 NoDampOff Seed Starter 24
 Novelty 146, 338-342, 404
 Nozzles, Watering .. 122-123, 126-128, 139-142
 NuLife 82
 Nursery Container, Black 330
 Nutgrass Killer 74
 Nyjer Seed 392-393, 395
- O**
- Oak and Birch Planters 314, 320, 353
 Obelisk 198, 294
 Ocean Forest Potting Soil 45
 Old Farmer's Almanac 211
 Old Farmer's Garden Calendar 211
 Olympia Black Urn 330
 One Touch Water Nozzle 118-123
 Open Sesame 170-171
 Operating Wrench 96
 Orchid Bark 35, 64
 Orchid Bloom Booster 13
 Orchid Food 13, 15
 Orchid Liquid 14, 15
 Orchid Mix/Soil .. 35, 42, 43, 48, 51, 57, 60, 64, 65
 Orchid Moss 35, 63
 Orchid Pot 326
- Organocide 268
 Organic Insect Control 14, 79, 227
 Organic Land & Sea Compost 42
 Organic Plant Food 15, 38, 39, 185
 Organic Potting Mix/Soil .. 15, 36, 37, 38, 41, 42, 44, 45, 49, 51, 52, 56, 61
 Organic Raised Bed Mix 15, 42, 45
 Organic Seed Starter 15, 26, 39
 Organic Time Release Plant Foods 185
 Organic Weed Control 268
 Organocide 268
 Original Planting Mix 36, 46
 Original Potting Soil 37
 Oriole Feeder 382
 Oriole Nectar 374, 391
 Orion Self-Watering Planter 333
 Oscillating Hoe 102
 Oscillating Sprinkler 125, 133-134, 137-138
 Outdoor Fertilizer Spikes 185, 193
 Oval Planter 314, 331, 364-365
 Oval Tub 303-304, 306, 364-365
 Owl Baby 245
 Owl Horned 206
 Owl Rotating Head 245
 Owl Inflatable 245
 Oxalis Control 70, 73, 228
- P**
- Packaged Bamboo Stakes 285
 Pallet Assortments 118, 328, 338, 352-353
 Palm Food 22, 154, 162, 166, 178
 Palm-tone 166
 Panacea 147, 215-218, 291-292, 343-345, 388-389
 Panterra Oval Pot 331
 Pasture Fertilizer 267
- Pattern Nozzles 118-120, 122, 128, 139-142
 Pattern Oscillating Sprinkler 125, 133-134, 137-138
 Pattern Rain Wand 118-120
 Peace Sign Planter 356
 Peach Tree Borer Trap 266
 Peanuts 378-379, 392, 394
 Peat Moss 44, 50, 51
 Peat Pellets 22
 Peat Pots 22
 Pedestal Urn 298
 Penobscot Blend Planting Mix 36
 Penra Bark 266
 Peony Support Rings 280, 289
 Perennial Rye Grass Seed 77, 79
 Perlite 41, 44, 50, 52, 60
 Pearl Stones 54
 PF Harris 136, 181, 254, 255, 256, 257
 Petunia FeED 184
 PH Meter 187-188, 258
 PH Tester 187-188, 258
 Pig Planter 310, 343, 345, 361, 406
 Pink Flamingos 202, 220, 399, 407
 Pipe Cutter 99
 Pistol Grip Nozzles 118, 122, 127
 Pixie Succulent Planter 333
 Plant Alarm 30
 Plant best 24-25
 Plant Caddy 323
 Plant Dolly 329
 Plant Food, Extended Release 154, 174, 183, 185, 191, 193
 Plant Hook 212, 213, 214, 216, 347
 Plant Label 23, 24
 Plant Mister 118, 148-149
 Plant Pal 148-149

Plant Pot Ring..... 303
 Plant Prod MJ 191
 Plant Props 289, 291
 Plant Shine 14
 Plant Spikes 22, 23, 185, 193
 Plant Stands 199, 204, 205, 206, 207, 208, 215, 315
 Plant Starter 39, 247
 Plant Support 279-294
 Planting Mix, Outdoor 36, 52, 57
 Plant-tone 166
 Plastic Bird Baths 373, 391
 Plastic Plant Labels 24, 30, 31, 288
 Plastic Sign Holder 30
 Plastic Water Breaker 121
 Plastic Water Nozzle..... 128
 Platform Hanging Bird Feeder 373
 Poison Ivy & Oak Killer 237
 Poles, Grow 279, 345
 Polished Stone 40, 54
 Poly Rake 89
 Poly Tarp 106, 284
 Poly Wheelbarrow 95
 Pop Uo Garden Tidy 86
 Post Hole Digger 102
 Post-Emergent Weed Control 68, 73-75
 Potash 169, 176, 182, 194
 Potato Tub Planter 369
 Pots, Clay 326-327, 353
 Potting Mix/Soil 15, 18, 52, 57, 61
 Pound In Edging 208
 Powder Duster 257
 Pre-Emergent Weed Control .. 70, 73, 75, 77, 79
 Preen 268-269
 Premier Tech Horticulture 27, 56, 57

Preserved Moss 55, 62, 63
 Pressure Sprayer 110, 111, 117
 Pride Garden Products 345, 405
 Pride Lands Defense 47
 Prima Planter..... 334-337
 Primitive Planters..... 346-349
 Pro-Mix 26,56-57
 Promo Bird Bath 391
 Promo Hand Tools 104, 403
 Promotional 2 Gal Watering Can .115, 136, 146, 150
 Propagation Dome 19, 22, 25, 28
 Proven Winners..... 62, 191
 Pruner Holster 95, 107
 Pruner Parts 107
 Pruners 19, 88, 90-92, 99, 101, 103-107
 Pruners, Anvil 88, 90, 104
 Pruners, Bypass 88, 90, 91, 99, 103-105
 Pruning Saw 89, 101
 Pruning Sealer 229, 237
 Pruning Set 104
 Pulaski Fire Axe 101
 Pulsating Sprinkler 123-124, 134
 Pulverize Weed 81
 Pumice Drainage Stone..... 59
 Pump & Grow 164
 Pure Gold 164
 Purse Planter, Metal 407
 Pyrethrin Garden Insect Spray 248

Q

Quad Thick 1020 Tray 29
 Quick Connectors ..121, 129-130, 133, 144-145
 Quick Grow Grass Seed 79-80
 Quoddy Blend Lobster Compost 36

R

Rabbit Repellents 235-236, 244-245
 Rabbit Scram 246
 Radians Garden 199-202, 400
 Railing Planters 302, 314, 322, 330, 341
 Railscares 303
 Rain Chain..... 198, 205
 Rain Gauge 187, 214, 220
 Rain Wand 118-120
 Raised Garden Bed Mix 36
 Rakes 85-87, 89, 92, 97, 104, 109
 Rapiclip 23, 287, 288
 Rapidtest Kits 187-189
 Rasied Bed Planter 314
 Rat & Mouse Bait Station 274
 Rat Magic 245
 Ratchet Pruner 99
 Rattan Hanging Basket 304, 345, 369
 Razor Tooth Folding Saw 89
 Rectangular Wood Trough..... 369
 Red Wagon Planter 215
 Redwood Planter 278
 Reindeer Moss 55, 63, 64
 Repair Kit (Felco) 107
 Repellent, All Purpose Animal 235, 236, 245
 Repels All..... 235, 236
 Replacement Blades (Felco) 107
 Replacement Spring Kit (Felco) 107
 Replant Kit, Earthbox 342
 Rescue, Sterling 269-271
 Retro Metal Planters 344
 Revenge Products 234, 236, 238
 Revitalize Biofungicide 238
 Revolver Nozzle 118, 122
 Ring Sprinkler 134, 138

- Rid Moss..... 82
River Gravel..... 49, 54
River North Collection..... 206
River Rock 53, 54
Roach Gel..... 254
Roach Control..... 255
Rocket Weeder..... 108
Rodent Control 252, 253, 255, 273
Rolled Rim Planter 360
Rooster Planter..... 311
Roosting Pockets 395
RootIRRIGATOR 96
Root & Vegetable Kit, Earthbox 342
Root Gel 16
Root Killer 81
Root Riot 16
Root Stimulant 14, 16
Rooting Hormone 14, 16, 247
Root-N-Grow 153
Roots Organic Formula 707 18
Roots Original Potting Soil 18
Root Slayer 85
Rot Stop..... 237
Rose Care 230, 240
Rose Food 38, 185, 240
Rose RX 230
Rose Shield 230
Rose Spikes 185, 193
Roses and Flowers Mix 37
Rose-tone 166
Rosie Bowl 317
Rot-Stop 237
Round Point Shovel..... 86, 87, 93, 100
Royal Gold LLC 57
Rubber Hose 125, 132, 147-148
Rubber Hose Washers 121, 135
Rustic Farmhouse Collection 343
- S**
- S Hook 213, 217, 347
Safehaven Animal -Rodent Traps..... 253
Safety Vest 223
Safflower Seed 378-379, 392
Salamander Soil Potting Mix 46
Sanco 271
Santa Fe Planter 333
Saturn Planter..... 301, 399
Saucer ..297, 300-301, 303, 308-309, 315, 317, 323, 326-327, 329-331, 334-337, 353
Saws..... 89, 92, 101, 103, 106
Scabbard..... 95
Schoodic Blend Compost Manure 37
Schultz..... 26, 192-193
Scissors..... 91, 103
Scoop 100
Scorch Guard 282
Scroll Pot Trellis 199, 280
Sea Shell Planter..... 311
Seabird Guano 158, 171
Season Long Grub Control 68-69
Seaweed Liquid 160, 172, 180, 190
Sedge Ender 228
Sedgehammer Herbicide..... 267
Seed & Cutting Mix..... 15, 16, 23, 27, 45
Seed Blanket 282
Seed Dispenser 23
Seed Sower 23
Seed Starting Kits 19, 21, 22
Seed Starting Pellets 22
Seed Starting Pots 22
Seed Starting Soil..... 15, 16, 17, 21, 24, 28
Seed Starting, Lawn 71-72, 77-78
Seed Trays 17, 19, 21, 22
Seeding Tool 22, 25
Seedling Heat Mats 17
Self-Watering Planters 314-315, 322-323, 339, 342, 359
Series Widger..... 95
Shady Grass Seed 67, 76-78
Shaina Planter 317
Sharpening Tool 91
Shaxon 218
Shears 15, 18, 19, 102, 105
Sheet Moss 53, 63
Shepherd Hook 198, 207, 212, 213, 214, 216
Shaxon 218
Shovels 85, 86, 87, 93, 97, 100, 105
Shower Planter 363
Shut Off Valve Connectors 129-131, 143-144
Silt Fence 285
Silver Fish Traps..... 255
Siphon Mixer Injector..... 126, 179
Sledgehammer 95
Sloth Planter..... 309, 401
Slug and Snail Control 231, 244, 260
Slug Magic..... 231
Sluggo 259
Smart Pot (High Caliper Growing)..... 26-27
Snake Repellent..... 236, 255
Snips 15, 18, 19, 88, 103
Soaker Hose 125, 132, 145
Sock, Thistle 393
Soil Acidfier..... 39, 43, 48
Soil Conditioner 45, 48, 49
Soil Cover 59
Soil Moist..... 27, 147, 193
Soil Penetrant..... 180

- Soil PH Tester 187, 189
- Soil Ripper..... 94
- Soil Tester..... 258
- Solar Lights 209
- Solo 110-111
- Sol Soils 58-59
- Sonic Spike..... 251
- Southern Patio 349-354
- Spade 93, 97
- Spanish Moss 53, 55, 63, 64
- Spartan Eco Cast Urn..... 317
- SPC Retail/Benchmaster 396
- Sphagnum Moss 44, 51, 53, 55, 62
- Sphagnum Peat Moss 42, 44, 50, 57, 60
- Spider and Ground Bee Control 232
- Spike Base Sprinkler 22, 23, 134, 137-139
- Spike Aerator 108
- Spikes, Plant..... 22, 23, 185, 193
- Spinosad..... 247
- Spotted Lanternfly Killer 256
- Sprayco 111-112
- Spray Tank Cleaner 109
- Sprayers 110-112, 136
- Spreader 71, 78
- Spreader Sticker 250
- Spring Back Rake 89
- Spring Lawn Booster 71
- Sprinkler High Rise 133
- Sprinkler Whirling 124, 134, 139
- Sprinkler, Impulse 124-125, 134
- Sprinkler, Oscillating 125, 133-134, 137-138
- Sprinkler, Sled Base 123, 134
- Sprinkler, Spike Base 124, 134, 138-139
- Sprinkler, Bubblers 133
- Sprinkler, Ring 134, 138
- Sprinkler, Tripod Base 125, 134, 138-139
- Sprinkler, Turret 124, 139
- Sprout Watering Tools 141-142
- Sprite Succulent Pot..... 332, 403
- Sprout Island Blend Seed Starter 15
- Spurge Control 70, 73-75, 264
- Square Planter..... 302-303, 305-306, 313-314, 319, 321-322, 331, 333, 339-340, 342-343, 349, 353-354, 359-360, 369
- Square Point Shovel..... 87, 93, 100
- Squirrel Bait 274
- Squirrel Proof Feeder 374-376, 382, 384
- Squirrel Repellent 259, 272
- Squirt Bottle 145
- St. Gabriel Organics 82, 273
- Stainless Steel Tools..... 88, 91, 104
- Stainless Steel Globe..... 219
- Stake Kit 285, 286
- Stakes, Bamboo 285, 286
- Stakes, Plastic Coated 285
- Stakes, Wooden 279, 285, 286
- Staking Kit, Earthbox..... 342
- Star Planter..... 314
- Starter Fertilizer, Lawn, Plant 72, 78, 80
- Starter Plus, Biotone..... 168, 170
- Statuary Planters..... 307, 368
- Steel Bird Bath Stand 350
- Steel Hose Hanger 133, 137, 147
- Steel Watering Can 118, 147, 149-150
- Steel Wheelbarrow 95
- Sterling Rescue 269-271
- Sticky Traps..... 255, 256, 272
- Stone Chips 266
- Stonington Areation 36
- Stonington Blend Grower's Mix 15
- Stonington Blend Organic Food 154
- Straight Blade Shear 90, 103, 105
- Straw 67, 71
- Strawberry Fields Potting Soil 46
- Strawberry Jar 361
- Stretch Tie 281, 287-288
- Strip Light LED 29
- Studio Dish Planter 303
- Stump & Vine Killer 81, 237
- Stump Out 237, 251
- Succulent Fertilizer 14, 15
- Succulent Planters .. 297, 303, 305-307, 309-314, 318, 321, 326-328, 332-333, 338, 342, 348, 350, 356-357, 359, 367-369
- Succulent Soil Mix 37, 44, 48, 52, 57
- Sucker Stopper 237, 263
- Suet Cakes 380-381, 393
- Suet Feeders 376, 381-382, 384, 386
- Sulfur 238, 251
- Sulfur Dust 251
- Summer Revitalizer 71, 78
- Summer Survival Insect Control 74-75, 78
- Summit 272-273
- Sun & Shade Grass Seed 76-77
- Sun Bulb 13, 35
- Sun Gro 30, 59-62
- Sunblaster Horticultural Lighting..... 28-30
- Sunflower Seed 378-379, 381, 392
- Sunlight Calculator 188
- Sunny Grass Seed 67, 76-80
- Sunshine Mix 27, 61
- Super Gasser 227
- Super Manure..... 50
- Super Moss 62-64, 293, 354-356, 390
- Super Soap..... 233
- Superthrive 30
- Sustane 194

- Sutton Planter 319
- Swan 147-148
- Swan Planter 361, 406
- Sweeper Nozzle 123, 141-142
- Sweet-Seed 390-391
- Swivel Hook 216, 218
- Syndicate 148-149, 356-359, 405
- Systemic Control (Disease) ..79, 80, 240, 269
- Systemic Control (Drench) 68, 74, 248
- Systemic Control (Insect) 14, 75, 232, 240, 251, 262
- Systemic Granules 14, 232, 240
- Systemic Insect Control (Acephate) 232
- Systemic Rose & Flower 230, 232, 240
- T**
- T5 Light 29
- Tahoe Planter 330
- Take Down Garden Spray 261
- Tall Planters ..302-303, 306, 318, 322, 339, 360
- Tampa Hanging Basket 351
- Tamp, Dirt 102
- Tank Sprayer 82, 106, 117, 249
- Tapered Edge Planter 338
- Tapestry Planter 305
- Tarps, Poly 106
- TDI Brands 30, 112, 149, 220, 405-406
- Tea Cart 208
- Tenax 293
- Termite Control 75, 234, 241
- Terra Cotta Clay Pots 326-327
- Terra Cotta Vinyl Saucers 309
- Terranova Planter 316
- Terra Tiller 109
- Terra Weeder 109
- Terrariums 348, 357-358
- Terrarium Tools 357
- Terrazzo Series Planters 330
- Testers, PH 187, 189
- Thatch Rake 97
- Thinning Shear 90
- Thistle Sock 393
- Thistle Killer 264
- Thrazux Eyewear Amber 202
- Thriving Design 293
- Thuricide BT 231, 250, 261
- Tick and Mosquito Repellent ...69, 74-75, 78-79
- Tick Control 69, 74-75, 78-79
- Tick Take Removable Spoon 272
- Tie Tape 281, 287-288
- Ties, Twist 278, 281, 287
- Tiger Bloom 170, 171
- Tilden Planter 315
- Time Release Fertilizers 176, 183, 191, 192
- Tin Planters 303, 304, 305, 306, 313, 325, 343, 344, 365, 366, 367, 369
- Tomato & Pepper Set 246
- Tomato & Veggie Insect Control ...233, 239, 243
- Tomato Blossom Set Spray 237, 262
- Tomato Cages 292
- Tomato Disease Control 233, 239
- Tomato FeED 184
- Tomato Food 154, 155, 164, 169, 170, 171, 172, 174, 175, 178, 182, 185, 190, 192
- Tomato Spikes 185
- Tomato Ties 287
- Tomato Tower 292
- Tomatoes and Vegetables Mix 37, 164, 172
- Tomato-tone 168
- Tools, Hand 91, 95, 104, 105, 112, 403, 405
- Topper Kona Grey 59
- Topper Original 59
- Topper Saharan Gold 59
- Topper Sedona Red 59
- Top Soil 35, 52, 61
- Topiaries 207
- Totem Pole 291, 345
- Touch Up Tri-Rye 79
- Transplanting Mix 58
- Traps, Disposable 270, 271
- Traps, Fly 238, 264, 269, 270
- Traps, Japanese Beetle 238, 269
- Traps, Mouse 251, 252, 254
- Traps, Wasp 270
- Traps, Yellow Jacket 264, 270, 271
- TrapStik 269, 270
- Trays 13, 21, 22, 29
- Tree & Shrub Care 231, 240, 247
- Tree & Shrub Food 80, 240
- Tree & Shrub Plant Mix 52
- Tree & Shrub Spikes 185
- Tree Feast 266
- Tree Fertilizer 80, 156-159, 162-163, 167, 172-177, 179, 181, 185
- Tree Food Spikes 154, 185
- Tree Netting 280
- Tree Pruner 92, 101
- Tree Stake 281, 285, 286
- Tree Watering Bag 118
- Tree Wrap 286
- Treekote 209
- Tree-tone 166-167
- Trellis 197, 199, 203, 207, 277, 278, 280, 290, 291, 294
- Trellis Netting 280, 282, 293
- Trellis Planter 320, 359
- Trench Shovel 97
- Triclopyr Ester 249

Tricycle Plant Stand 215, 325
 Tricycle Planter 325
 Trio Pack 171
 Trio Planter 342, 357, 313, 320-321
 Triple Phosphate 168, 176
 Tripl Action 247
 Tripod Sprinkler 125, 134, 137, 138, 139
 Tripod Support 294
 Trough Planter 305-306, 313, 315, 370
 Trowel, Hand 86, 91, 104, 105, 112, 405
 Trunk Mat Liners 112
 Tub Trugs 85, 400
 Tube Feeder 373, 374, 376, 382, 384, 386
 Tunnel, Grow 280
 Tuper Mix 57
 Turf Booster 266
 TURF MAC Soil Treatment 48
 Turtle & Snail Planter 368, 407
 Tusco Products 359-360
 Tuxon Planter 302
 Twine 280, 286, 287, 288
 Twist Nozzle 121, 123, 128, 140
 Twist Ties 281, 287, 288
 Twists and Clips 281, 288
 Tyne Moulds 30-31, 294
 Typar 284

U

Ultra Black Beauty Grass Seed 76-78
 Ultra Outdoor Planting Mix 61
 Ultra Potting Mix w/Extend Feed 61
 Union-Cado 150, 220, 361, 391, 406-407
 Universal T5 Light Strip Hanger 29
 Universal T5 Stand 28
 U-Pins 284

Upright Grow Bags 17, 18, 26, 27
 Urns 298, 302, 303, 313, 316, 317, 321, 330, 340, 351, 353, 360
 Utopian Urn Planter 353

V

Vacation Mats 147
 Vase, Glass 357, 358
 Vegetable Disease Control 233, 239
 Vegetable Food 154-172, 175-185, 189-190, 192, 194
 Vegetable Garden Mix/Soil ... 36, 37, 42, 44, 56
 Vegetation Killer 227, 228
 Venetian Flower Box 330
 Vented Dome 19, 25
 Vermiculite 44, 50, 52
 Verona Planter 317
 Very Cool Stuff 219, 362-369, 407-408
 Vine Killer 81, 237, 263
 Vine Net 288
 Vinegar 255, 271
 Vinegar 255, 271
 Vintage Feeders 376-377, 387
 Vintage Seed Buckets 215
 Vintage Watering Can 147
 Vinyl Hose Washers 135, 145
 Vinyl Loop Lock Labels 31
 Vinyl Saucer 308-309
 Violet! 15, 48, 59
 Vitamin Solution 186
 Volcanic Rock 49
 Vole Control 245
 Vole Scram 245
 VPG .. 16, 43-45, 72-75, 107, 173-177, 245-251

W

Wall Bracket outdoor 198
 Wall Decor 219
 Wall Planter 324-325, 343, 362, 367, 360
 Wash Tub Planter 344
 Washers, Hose 121, 135, 145
 Wasp & Hornet Killer 230, 270
 Water Breaker 121
 Water Hose, Rubber ... 125, 132, 145, 147, 148
 Water Nozzles 122-123, 126-128, 139-142
 Water Retention Mat 147
 Water Soluble Plant Foods 20, 183, 184, 191
 Water Timer 117, 119, 135, 142, 143
 Watering Can Planter 356, 362, 363, 367
 Watering Cans .. 115-116, 118, 126, 136, 146-147, 149-150, 404, 405
 Watering Wands ... 118, 119, 120, 123, 128, 141
 Waupaca 82
 Watson Gloves 220-222, 408
 Weather Guard 375
 Weed & Feed 70, 72-73, 75, 77, 82, 229
 Weed & Grass Killer 68-70, 73, 75, 81-82, 244, 251
 Weed Beater 68, 228
 Weed Control 68-71, 73-75, 77, 79, 81-82
 Weed Fabric 208, 280, 283, 284, 286
 Weed Preventer, Garden 280
 Weed Preventer, Lawn ... 68, 70-71, 73, 75, 77, 79-82
 Weed Prevention Plus 257, 269
 Weeder 85, 86, 91, 92, 94, 104, 105, 109
 Weep and Soak Hose 125, 132, 145
 West Chester Holdings LLC 222-223
 Western State 186
 Westland 223, 369
 Whisk Rake 109
 Whiskey Barrel 320, 329, 353

White Marble 54	Winterizer 71, 78, 194	Y
White Sand 40, 54	Wire Basket Planter 297, 304, 307, 323, 324, 344, 345, 354, 369, 370	Yard Breather 92
White Stone 54	Wiscasset Earthworm Castings 37	Year Round Spray Oil 272
Wholly Mackerel Fish Fertilizer 172	Wood Grain Planter 311	Yellow Duck Planter 309, 401
WHY Traps 270	Wooden Obelisk 280	Yellow Jacket Traps 265, 270, 271
Wicasset Earthworm Castings 36	Wooden Planters 278, 298, 306, 320, 329, 359, 369	Yield Booster RTU 247
Wicker Planter 307	Wooden Tree Stake Kit 281, 285, 286	Y-Shut Off Connector 129-131, 143
Wilco 273-274	Wooden Trellises 277, 278, 290, 291	Z
Wild Delight Bird Food 392-395	World's Greatest Rake 105	Zinc Homeroowner Bait 273
Wildflower Mix 67, 79, 80	World Source Partners 31, 150, 223, 369-370, 395	Zinc Plant Labels 23
Wildflowers Seed Mixture 67, 79, 80	Worm Castings 154, 181-182	Zinc Pots 364
Wilt Stop 229	Woven Baskets 304, 307, 345, 354, 369	Zinc Supplement 186, 273
Wilt-Pruf 194	Woven Rope Roosting Pockets 395	Zinc Water Couplers 129-130, 144
Wind Art 209, 210	Wrapound Peony Support 280	Zombie Flamingos 220
Wind Chimes 209, 210	Wreath Hanger 218	
Window Box Planter 298, 300, 314, 315, 319, 321, 322, 330, 340, 341	Wren House 373, 375, 384-385, 389	
Window Box Planter Tray 330, 340	Wren Scroll Trellis 203, 280	
Windy Wings 209, 210, 403	Wrench 96	
Winter Fabric 282, 284		

Credit Application

INTERESTED IN APPLYING FOR CREDIT?

Credit applications can be completed online.

Email creditapplication@griffinmail.com to receive an email with a link to our secure online portal.

If you are unable to access the online form you can call us at 800.888.0054 and ask for the Credit Dept.





Perennials

POINT OF PURCHASE SIGNAGE

We make what you need. We offer complementary design services and a wide variety of sign options.

Don't see what you desire?
Call us at 419-666-3662 x 102.

**FREE DESIGN WORK
ON ALL CUSTOM ORDERS!**



Perennials



Sunny Annuals



Shade Annuals



Herb Garden



Vegetables



Poinsettias

Pre-designed Poster Options

- 2 sided printing on Coroplast
- Full color print
- UV coated
- Grommets for easy hanging (24x36)

16" x 24"

Item	Description
PP-1623PE	Perennials
PP-1623PO	Poinsettias
PP-1623SH	Shade Annuals
PP-1623SU	Sunny Annuals
PP-1623VG	Vegetables
PP-1623HG	Herb Garden

24" x 36"

Item	Description
PP-2436PE	Perennials
PP-2436PO	Poinsettias
PP-2436SH	Shade Annuals
PP-2436SU	Sunny Annuals
PP-2436VG	Vegetables
PP-2436HG	Herb Garden

Custom Coroplast Posters

- Printed in UV cured ink/long-lasting durability
- Full color bleeds
- Durable high-quality outdoor 4mm coroplast
- Shipped within 5 days of proof approval
- Custom sizes available

Options

- Grommets in top corners - Free
- Double Sided - Additional cost, same as front or new image

Step stakes available Item # PP-SS

Custom Vinyl Banners

- Printed in true digital color
- Full color bleeds
- Durable high-quality outdoor 13oz scrim vinyl
- Reinforced on all 4 sides with banner welding
- Drop-shipped within 5 days of proof approval

Options

- **Grommets (2-3')** - Free
- **Rope** - Additional cost
 - 500 pound nylon cord welded with 2' of slack
 - Location: top, bottom, top & bottom
- **Pole Pockets** - Additional cost
 - Size: 1, 2, 3, or 4" (Dimensions unchanged)
 - Location: top, bottom, top & bottom, left, right, left & right

Many other substrates available. Contact Customer Service 800.888.0054
Ask your sales person for more details.

GROWING CALENDAR

Limitless Dark Rose and Limitless Sunset from Syngenta Flowers

Full Moon Days
 Holidays

2025

JANUARY

WEEK	S	M	T	W	T	F	S
1				1	2	3	4
2	5	6	7	8	9	10	11
3	12	13	14	15	16	17	18
4	19	20	21	22	23	24	25
5	26	27	28	29	30	31	

FEBRUARY

WEEK	S	M	T	W	T	F	S
5							1
6	2	3	4	5	6	7	8
7	9	10	11	12	13	14	15
8	16	17	18	19	20	21	22
9	23	24	25	26	27	28	

MARCH

WEEK	S	M	T	W	T	F	S
9							1
10	2	3	4	5	6	7	8
11	9	10	11	12	13	14	15
12	16	17	18	19	20	21	22
13	30	23	31	24	25	26	27

APRIL

WEEK	S	M	T	W	T	F	S
14			1	2	3	4	5
15	6	7	8	9	10	11	12
16	13	14	15	16	17	18	19
17	20	21	22	23	24	25	26
18	27	28	29	30			

MAY

WEEK	S	M	T	W	T	F	S
18					1	2	3
19	4	5	6	7	8	9	10
20	11	12	13	14	15	16	17
21	18	19	20	21	22	23	24
22	25	26	27	28	29	30	31

JUNE

WEEK	S	M	T	W	T	F	S
23	1	2	3	4	5	6	7
24	8	9	10	11	12	13	14
25	15	16	17	18	19	20	21
26	22	23	24	25	26	27	28
27	29	30					

JULY

WEEK	S	M	T	W	T	F	S
27			1	2	3	4	5
28	6	7	8	9	10	11	12
29	13	14	15	16	17	18	19
30	20	21	22	23	24	25	26
31	27	28	29	30	31		

AUGUST

WEEK	S	M	T	W	T	F	S
31						1	2
32	3	4	5	6	7	8	9
33	10	11	12	13	14	15	16
34	17	18	19	20	21	22	23
35	31	24	25	26	27	28	29

SEPTEMBER

WEEK	S	M	T	W	T	F	S
36		1	2	3	4	5	6
37	7	8	9	10	11	12	13
38	14	15	16	17	18	19	20
39	21	22	23	24	25	26	27
40	28	29	30				

OCTOBER

WEEK	S	M	T	W	T	F	S
40				1	2	3	4
41	5	6	7	8	9	10	11
42	12	13	14	15	16	17	18
43	19	20	21	22	23	24	25
44	26	27	28	29	30	31	

NOVEMBER

WEEK	S	M	T	W	T	F	S
44							1
45	2	3	4	5	6	7	8
46	9	10	11	12	13	14	15
47	16	17	18	19	20	21	22
48	30	23	24	25	26	27	28

DECEMBER

WEEK	S	M	T	W	T	F	S
49		1	2	3	4	5	6
50	7	8	9	10	11	12	13
51	14	15	16	17	18	19	20
52	21	22	23	24	25	26	27
1	28	29	30	31			

2026

JANUARY

WEEK	S	M	T	W	T	F	S
1					1	2	3
2	4	5	6	7	8	9	10
3	11	12	13	14	15	16	17
4	18	19	20	21	22	23	24
5	25	26	27	28	29	30	31

FEBRUARY

WEEK	S	M	T	W	T	F	S
6	1	2	3	4	5	6	7
7	8	9	10	11	12	13	14
8	15	16	17	18	19	20	21
9	22	23	24	25	26	27	28

MARCH

WEEK	S	M	T	W	T	F	S
10	1	2	3	4	5	6	7
11	8	9	10	11	12	13	14
12	15	16	17	18	19	20	21
13	22	23	24	25	26	27	28
14	29	30	31				

APRIL

WEEK	S	M	T	W	T	F	S
14				1	2	3	4
15	5	6	7	8	9	10	11
16	12	13	14	15	16	17	18
17	19	20	21	22	23	24	25
18	26	27	28	29	30		

MAY

WEEK	S	M	T	W	T	F	S
18						1	2
19	3	4	5	6	7	8	9
20	10	11	12	13	14	15	16
21	17	18	19	20	21	22	23
22	31	24	25	26	27	28	29

JUNE

WEEK	S	M	T	W	T	F	S
23		1	2	3	4	5	6
24	7	8	9	10	11	12	13
25	14	15	16	17	18	19	20
26	21	22	23	24	25	26	27
27	28	29	30				



ONLINE ORDERING

www.griffins.com

CONTACT GRIFFIN

Email: orders@griffinmail.com

Phone: 800.888.0054

Grower/Retail Fax: 877.636.3623

Plant & Seed Fax: 610.913.3091

PLANTS & SEED | GROWER SUPPLIES | RETAIL | CEA | CONSTRUCTION

© 2025 Griffin Greenhouse Supplies, Inc. The trademarks displayed or otherwise used herein are registered and unregistered trademarks of Griffin Greenhouse Supplies, Inc., or third parties.

