



GRIFFIN

RETAIL CATALOG

2024

ALTOGETHER. BETTER.

Plants & Seed | Grower Supplies | Retail | CEA | Construction



ABOUT GRIFFIN

Griffin is a partner to horticulture professionals. Family owned and operated since 1947, we apply our knowledge, experience and resources to enhance customer success from production to retail.

End-to-end solutions are our specialty. We represent the industry's leading breeders and producers, spanning seed and vegetative, bedding and potted crops, ornamentals and edibles. Our grower supplies offer includes reliable inputs and equipment to help your crops thrive through all production stages. Finally, our quality retail products drive add-on sales for you, while enhancing consumer success and enjoyment.

To learn more about our company, we invite you to visit us online at www.griffins.com, follow us on LinkedIn, Instagram and Facebook.

A LEGACY OF QUALITY AND SERVICE

Charlie Griffin founded his namesake company in 1947 with a simple vision: To maximize products and service for his customers. Originally headquartered in Reading, Mass., his was a one-man operation with a limited offering, delivering supplies to growers in the local community.

Ken Hyslip, Sr. first became an employee of Griffin Greenhouse Supplies in 1952, as a truck driver at the age of 17. At the time, Griffin operated from a single location with no more than five employees. He went on to buy the business from the Griffin family in 1968. Under his leadership, Griffin grew steadily across the East Coast.

Today, Griffin thrives among horticulture's premier distributors, serving growers and retailers nationwide. Under the leadership of the Hyslip family, the business has earned a reputation for operational excellence, quality products, and first-class customer service.

We know you have many choices among supplier partners, and we sincerely thank you for your business. We look forward to serving you in the season ahead.

GRIFFIN IS COMMITTED TO EXCEPTIONAL CUSTOMER SERVICE

Our goal is simple: To meet your needs and exceed your expectations. From the time you place your order until it's delivered to your location, our team works to treat you with the utmost care every step of the way.

We strive to deliver every order on time and in full. We'll contact you 24 hours before your delivery date to ensure you're ready for the product. If we're unable to honor a delivery date, we'll notify you in advance and make every effort to reschedule at a time that's convenient for you. In the event of any issue, we're dedicated to working with you and our suppliers as needed to find a swift resolution.

Your opinion matters to us! Customer feedback is key to helping our team deliver on our service pledge. Please don't hesitate to contact me directly – by phone or e-mail – with any questions or input that may help us serve you better.

Dan Lowery | Corporate Customer Service Manager | 800.888.0054 x81404 | dlowery@griffinmail.com

GRIFFIN LOCATIONS

Fourteen Distribution Centers Throughout the United States



TO PLACE AN ORDER

Phone: 1.800.888.0054

Grower / Retail Fax: 1.877.636.3623

Green Goods Fax: 630.969.6373

E-mail: orders@griffinmail.com

GENERAL QUESTIONS

1.800.888.0054

ONLINE ORDERING

www.griffins.com

OFFICE HOURS

Our office is open for normal business and telephone service from 8:00 AM to 5:00 PM, Monday through Friday.

WAREHOUSES

Hours for pick-up orders and counter sales are 8:00AM to 5:00PM, local time, Monday through Friday.

BRANCH LOCATIONS

5303 Havana St, Suite 120
Denver, CO 80239

20 Grandview Ct
Cheshire, CT 06410

10 Middle River Drive
Stafford Springs, CT 06076

5350 Ball Ground Hwy
Ball Ground, GA 30107

2143 Internationale Parkway
Suite 400, Woodridge, IL 60517

1619 Main St
Tewksbury, MA 01876

50 W Gray Rd
Gray, ME 04039

1240 B Hwy 77
Bridgeton, NJ 08302

1 Ellis Dr
Auburn, NY 13021

2165 Montauk Hwy
Brookhaven, NY 11719

126 Van Guysling Ave
Schenectady, NY 12305

58 S.E. 223rd Ave.,
Gresham, OR 97030

200 Mountain View Rd
Morgantown, PA 19543

5612 Pride Rd
Richmond, VA 23224







PRODUCTION SUPPLIES

Griffin's roots are in production supplies, and they remain the backbone of our company today. We're proud to offer reliable inputs and equipment to help your crops thrive through all growing stages. Look to us for containers, growing media, chemistry and more from the manufacturers you know and trust. With the increasing demand for more efficient and environmentally friendly methods of growing food crops, we now specialize in Controlled Environment Agriculture for food and cannabis. Our 14 branch locations service customers nationwide with convenience and efficiency. Shop all of our grower products and place your order with your Griffin sales representative or on www.griffins.com.

RETAIL SOLUTIONS

Griffin is the independent retailer's best source for lawn & garden products. We make it easy for IGCs to do business, with complete vendor offerings, low order minimums and efficient shipping solutions. Raise your retail game with help from our experts! Count on us for seasonal promotion ideas, merchandising best practices and space-planning tips to maximize your display areas and drive sales. Shop all of our retail products and place your order with your Griffin sales representative or on www.griffins.com.

GREEN GOODS

Griffin is a full-service broker of live goods to professional growers. Our assortment includes seed and vegetative material, bedding and potted crops, ornamentals and edibles from the industry's most respected breeders and producers. We're uniquely committed to the seed business, stocking more than 3,300 variety/product-form combinations in our state-of-the-art seed operations facility. Count on us for annuals, perennials, grasses, herbs and vegetables. We're serious about seed quality: Inventory monitoring and regular performance testing ensure every variety meets its full potential, from the greenhouse to the garden center. Browse our complete portfolio and book your product selections through your Griffin sales representative or on www.griffins.com.

TECHNICAL SUPPORT

GGSPRO is our in-house technical services team. With more than a century of combined experience, GGSPRO delivers prompt, practical and accurate support to Griffin customers nationwide. The team's areas of expertise include: Crop culture, sanitation protocols, plant physiology and pathology, chemical controls, biological control agents (BCAs), and plant nutrition. GGSPRO endorses a holistic approach to plant protection, utilizing a mix of cultural practices alongside chemical and biological controls to manage pests and diseases. Visit www.griffins.com/ggspro or contact GGSPRO at **1.800.888.0054**.

CONSTRUCTION SERVICES

Our construction team assists with all aspects of greenhouse planning, construction and maintenance. Whether it's a new operation or expansion, upgrades or replacements, we can help with options to meet your needs and fit your budget. We offer a full range of equipment to help you grow efficiently and profitably. Look to us for greenhouse structures, films and coverings, lighting, climate control, irrigation, carts and more. Visit us at www.griffins.com/construction to learn more about our product portfolio, see our project showcase, and submit a request for a free quotation.

Table of **CONTENTS**



SEED STARTING AND
INDOOR GARDENING

11



SOILS, CONDITIONERS
AND GROUND COVER

33



PLANT CARE
AND FOOD

133



GARDEN
ACCESSORIES

169



BIRDING

337



KIDS
GARDENING

359



LAWN CARE AND
GRASS SEED

61



TOOLS AND
EQUIPMENT

79



WATERING SUPPLIES
AND IRRIGATION

103



LAWN AND GARDEN
PROBLEM SOLVERS

199



CROP
SUPPORT

241



POTS AND
PLANTERS

261



INDEX

369



LOOK FOR QR CODES

throughout the catalog and
scan with your phone for
digital information.

CONNECT

with us

SOCIAL MEDIA

Add us to your social network! For news on products, events and more, follow us on LinkedIn and like us on Facebook. Simply log on and search "Griffin Greenhouse Supplies." Also follow us on Instagram. Log on and search "Griffin Greenhouse".



GRIFFIN GAZETTE

Published especially for top customers, the Griffin Gazette is loaded with news you can really use. Our team serves up timely production advice, retail inspiration, and product and variety information to help you bring your best crop to market.

Check out the digital Gazette for exclusive bonus content not available in print! Visit www.griffins.com/publications to browse the Gazette archives.



E-MAIL PROGRAMS

We offer several topical e-mail programs for growers and retailers. Tailor your subscriptions to meet your unique needs and interests, from technical tips to product specials and much more. Visit www.griffins.com to subscribe or update your preferences.

GRIFFIN CATALOGS

From production to point-of-sale, we've got you covered! Our Grower Supplies, Seed & Plant, CEA and Retail catalogs feature must-have inputs from quality manufacturers, breeders and producers.

Contact your Griffin sales representative to request our catalogs, or check out our convenient and portable digital editions at www.griffins.com/publications.



SOURCING HAS NEVER BEEN THIS SIMPLE

One login connects you to the industry's broadest selection of products for growers and independent retailers:

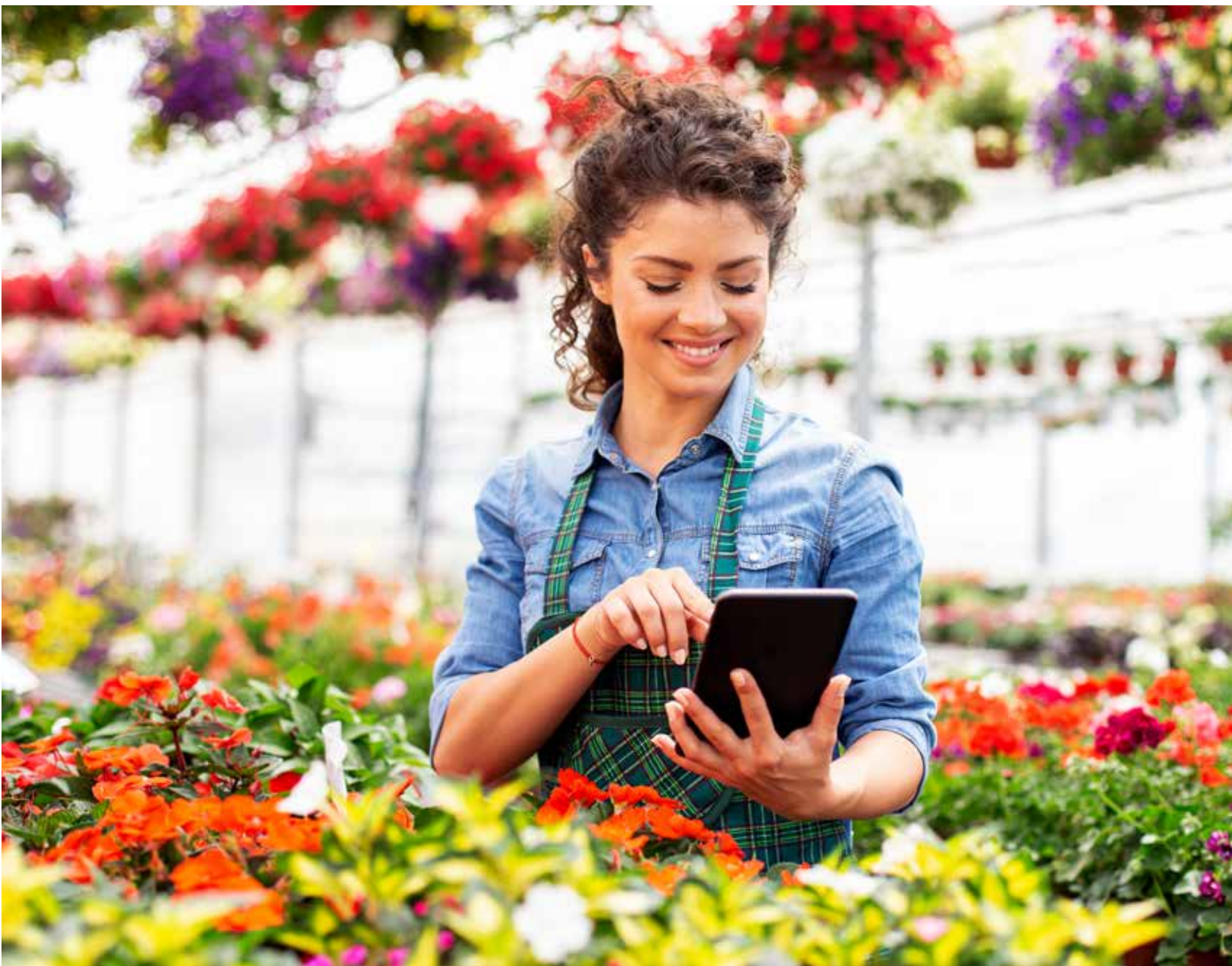

- Green goods including seed, cuttings and young plants
- Production supplies including containers, growing media and plant protection products
- Greenhouse structures and equipment
- Retail supplies including lawn & garden products, accessories and gift items



CHECK OUT OUR
CLEARANCE ITEMS!

Place your order today: www.griffins.com

WHAT'S NEW!

new vendors with griffin

WEST

Atlas Chemical201
 Dr. Earth ...38-39, 67, 140-143, 217-218
 Exotic Pebbles & Glass39-40
 Grow More.....154-158
 Midwest Air Technologies255-256
 Wilco240
 A&G Agricultural Supply243-245
 Malibu Compost(DS Only)
 Royal Gold (DS Only)

NATIONAL

American Lawn Mower81
 Bacon/Hummer's Galore345
 Devault296
 Down to Earth137-140
 Mossify.....24, 53, 98, 127, 254
 Sanco78, 238
 Sprayco101-102
 Spinfinity(DS Only)

EAST

Amturf63
 Garman Coco Shell Mulch44

NATIONAL



SEED STARTING & INDOOR GARDENING



CHECK OUT OUR CLEARANCE ITEMS!

DROP SHIP VENDORS

Renee's Garden

Dealer Cost: 50% off Retail

Buy Back Terms:

Payment due 7/1/23

50% returnable, returns due by 9/30/23

Credit issued after return

Outright Buy:

Applies only to Scatter Garden Canisters (40% off retail price)

Retail Price Point:

Cornucopia \$1.99 - \$2.49/Organic \$3.29

Renee's Garden \$2.99-\$3.69/Organic \$4.39

Scatter Garden canisters \$15.95ea

Timing:

Opening orders must be written and shipped before March 31, 2023

Freight:

4% of invoice. Scatter display \$40

Ferry Morse

Seed of Change 45% off Retail

Terms of Sale:

Both part 1 and part 2 must be ordered for all displays that ship as two parts: no partial display orders

Ourright Sales:

Terms Net 30 Days

Guaranteed Sale:

Maximum return credit of 50% of total packets shipped.

Payment Due 8/1, regardless of whether returns have taken place

\$9.50 Return Fee Applies for shipping & handling

Page Seed

Outright Sale

PrePriced:

Liberty Garden \$0.99

Organics \$2.49-\$2.99

Page Premium \$ 1.89-\$4.99

Specialty Gardens \$1.89-\$4.99

Theme \$1.89

Urban \$ 2.89

FOB Greene, New York

Livingston Seed

Buy Back Terms:

Payment Due 8/1/23

50% returnable, returns due by 9/30/23

Credit issued after return

Outright Sale 58% off Retail

Guaranteed Sale 45% off Retail

Freight is prepaid within Continental 48



Griffin Greenhouse Retail WAREHOUSE Shipping Map

We are now shipping nationwide!

NATIONAL



2024

Refer to location key:

National items are stocked nationally
 Select items are sold East or West only; no exceptions

8" Kaleidoscope Planter

Premium plastic modular planter can be displayed individually each planter has a removable saucer ideal for succulents or shallow rooted planted.

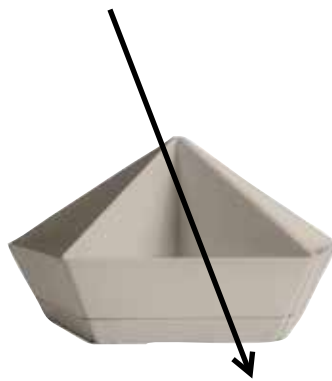

Item #	Desc	UPC	Vendor	CS/UOS	Location
80282643	Vanilla Bisque	770932844170	KDP08000A58	6/6	National

Where is the pricing?

1. Scan QR code on Chapter Pages to see pricing on Griffins.com
2. Contact your Griffin Sales Representative
3. Call into Griffin Customer Service 800.888.0054





Orchid Plus® 20-14-13

Urea-free, professionally formulated plant food, containing fast-acting nitrate nitrogen – the key component to enhancing vigorous growth in orchids. It also contains essential minor elements to combat deficiencies that occur with common soilless potting mixes. Convenient re-sealable bag.



Item #	Desc	UPC	Vendor	CS/UOS	Location
81830009	16 oz. bag	079925083030	83030	12/12	East

Houseplant, Bromeliad & Orchid Food

In addition to being a great source of nitrogen, phosphorus, and potassium, this product includes essential minor elements to combat nutrient deficiencies. Safe for use on all houseplants and orchids. No mixing, no mess; just sprinkle and go. Convenient re-sealable bag. Feeds continuously for up to 12 months.



Item #	Desc	UPC	Vendor	CS/UOS	Location
81830011	10 oz. bag	079925083078	83070	12/12	East

Orchid Better-Bloom® 11-35-15

Urea-free, professionally formulated plant food containing high-content phosphorous; a powerful blooming agent! This secret formula was developed by our own master growers and is used in our greenhouses to accelerate flowering, enhance bloom color and maximize bloom size. Convenient re-sealable bag.



Item #	Desc	UPC	Vendor	CS/UOS	Location
81830010	16 oz. bag	079925083054	83050	12/12	East



Square Tray

39.5" X 39.5" X 4.75"



Item #	Desc	UPC	Vendor	CS/UOS	Location
82010501	Square Tray	5031670002570	N130	2/2	National

Giant Plus Tray

47" X 21.5 X 2"



Item #	Desc	UPC	Vendor	CS/UOS	Location
82010573	Giant Plus Tray	5031670002143	N124	6/6	National

Indoor Plant Pot Tray

19" X 6" X 0.75"H

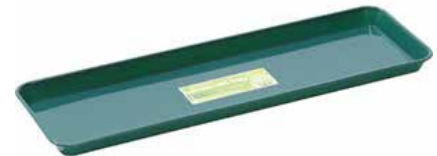

Item #	Desc	UPC	Vendor	CS/UOS	Location
82010627	Indoor Plant Pot Tray	5031670001832	N114	10/10	National

Maxi Tray

31" X 16" X 2"H



Item #	Desc	UPC	Vendor	CS/UOS	Location
82010629	Maxi Tray	5031670002020	N120	10/10	National

SOCIAL MEDIA

Connect with us!

We offer several topical posts for growers and retailers. Follow us and check out our posts!

Instagram: **@griffin_greenhouse**

Facebook: **Griffin Greenhouse Supplies, Inc.**

Linkedin: **Griffin Greenhouse Supplies**





2024

Mite-X®

A specific miticide for houseplants. Also kills aphids and thrips. A pleasantly scented Garden Naturals® product made from botanical extracts. **Not for sale in PR**

Item #	Desc	UPC	Vendor	CS/UOS	Location
80100005	12 oz.	037321001140	114	8/8	National

Bontone® Rooting Powder

Ideal for houseplant cuttings. Speeds root development for ornamentals, vegetables, fruit trees, and berries. Simply cut, dip, and plant.

Item #	Desc	UPC	Vendor	CS/UOS	Location
80100041	1.25 oz.	037321009252	925	12/12	National

Systemic Houseplant Insect Control

For use in potted plants. No odor, easy to use granules provide insect control for up to 8 weeks!

Not for sale in CT, MA, MD, NY, PR, VT

Item #	Desc	UPC	Vendor	CS/UOS	Location
80100043	8 oz.	037321009511	951	12/12	National

Liquid Plant Food 10-10-10

A balanced fertilizer ideally formulated for houseplants. Just seven drops per quart of water for lush, healthy plants.

Item #	Desc	UPC	Vendor	CS/UOS	Location
80100049	8 oz.	037321001089	108	12/12	National

Eight® Insect Control

No odor, non-staining, all purpose insecticide. Kills insect and disease pests on over 60 varieties of ornamentals and houseplants. Great for container gardens too. Contains sulfur and all-natural pyrethrins.

Item #	Desc	UPC	Vendor	CS/UOS	Location
80100050	12 oz.	037321001102	110	8/8	National

Insecticidal Soap - Organic

1% Potassium fatty acids. Derived from plants - for plants, Kills insects on contact. For indoor and outdoor use.

Item #	Desc	UPC	Vendor	CS/UOS	Location
80100051	12 oz.	037321001126	112	8/8	National

Leaf Shine & Moisture Guard

Anti-transpirant reduces harmful water loss. Adds a natural looking shine. For use on all houseplants with hard faced leaves.

Item #	Desc	UPC	Vendor	CS/UOS	Location
80100052	12 oz.	037321001164	116	8/8	National

Liquid African Violet Plant Food

Just a small amount with each watering brings forth beautiful blooms, lush foliage and excellent plant vigor of all flowering plants. Formula 7-10-7 AVF

Item #	Desc	UPC	Vendor	CS/UOS	Location
80100797	8 oz.	037321001065	106	12/12	National

Liquid Cactus Plant Food

With a 2-7-7 N-P-K ratio, this tropical plant food has been specifically formulated to meet the unique needs of cacti and succulents.

Item #	Desc	UPC	Vendor	CS/UOS	Location
80100798	8 oz.	037321001072	107	12/12	National

Coast of Maine

Sprout Island Blend™ Organic & Natural Seed Starter



A rich mixture of blended mycorrhizae, sphagnum peat moss, well-aged compost, perlite, lime, kelp meal, worm castings, and lobster meal. Designed specifically for germinating seeds and rooting cuttings, and growing them into healthy, disease resistant plants. OMRI Listed.

Item #	Desc	UPC	Vendor	CS/UOS	Location
81600029	16 qt	609853000917	SI4002	4/4	East
81600045	2 cf	609853000924	SI2000	48/4	East

Stonington Blend™ Organic & Natural Grower's Mix



Grow Clean! Stonington Blend was created specifically for growing Cannabis. Rich in nutrients and formulated with amendments esigned to boost budding, blooming and root development, this complex "super soil" will take your plants growing in the vegetative stage to the next level! Designed for high performance growing in containers and large pots, this blend incorporates mycorrhizal ungi, kelp, fish bone and alfalfa meals, worm castings, peat, coir, and lobster compost. For best results, grow in 15 gallon containers. OMRI Listed.

Item #	Desc	UPC	Vendor	CS/UOS	Location
81600012	1.5 cf.	609853000689	ST1500	60/6	East

DRAMM

Little Buddy™ Hydroponic Shears

The 3" long blades are narrow to allow for precise cutting of hydroponic crops. The Hydroponic Shears are bright yellow for visibility.



Item #	Desc	UPC	Vendor	CS/UOS	Location
80170144	Titanium	036434180339	1018033	12/12	National
80170145	S. Steel	036434180377	1018037	12/12	National



Indoor! 2-2-2

8 oz. liquid concentrates contain natural proteins and beneficial microbes that provide beautiful results. The innovative easy-dose cap pours the perfect amount without any measuring or mess.

Item #	Desc	UPC	Vendor	CS/UOS	Location
80030165	8 oz.	050197305082	INPF8	6/6	National

Violet! 1-3-1

8 oz. liquid concentrates contain natural proteins and beneficial microbes that provide beautiful results. The innovative easy-dose cap pours the perfect amount without any measuring or mess.

Item #	Desc	UPC	Vendor	CS/UOS	Location
80030167	8 oz.	050197307086	VIPF8	6/6	National

Cactus! 1-2-2

8 oz. liquid concentrates contain natural proteins and beneficial microbes that provide beautiful results. The innovative easy-dose cap pours the perfect amount without any measuring or mess.

Item #	Desc	UPC	Vendor	CS/UOS	Location
80030166	8 oz.	050197306089	CAPF8	6/6	National

Orchid! 1-3-1

8 oz. liquid concentrates contain natural proteins and beneficial microbes that provide beautiful results. The innovative easy-dose cap pours the perfect amount without any measuring or mess.

Item #	Desc	UPC	Vendor	CS/UOS	Location
80030168	8 oz.	050197308083	ORPF8	6/6	National

Organic Seed Starter Mix

For all seedlings and cuttings. Premium blend of sphagnum peat moss, peat humus and perlite that has been enriched with Myco-tone®. Promotes root growth and improves moisture retention.

Item #	Desc	UPC	Vendor	CS/UOS	Location
80030041	8 qt.	050197705080	SS8	6/6	National
80030097	16 qt.	050197705165	SS16	6/6	National



Seed & Cutting Mix

Ideal starter for germinating seeds and rooting leaf, stem, and root cuttings. The sphagnum peat blend with a wetting agent provides an excellent balance between moisture retention and air capacity to prevent root disease while promoting efficient rooting.



Item #	Desc	UPC	Vendor	CS/UOS	Location
82280383	8 qt.	066498099254	9925	6/6	East
82280382	16 qt.	066498099292	9929	120/10	East



Grow Big® Hydroponic Liquid Plant Food 3-2-6

Liquid concentrate fertilizer specifically designed for hydroponic use. Designed to enhance plant size and structure, allowing for more abundant fruit, flower and bud development.



Item #	Desc	UPC	Vendor	CS/UOS	Location
82000110	1 pt	752289793219	793219	12/12	National

SOWING YOUR OWN PRODUCTION?

Sow something Altogether. Better. Griffin stocks 3,300+ seed variety/product-form combinations—annuals, perennials, grasses, herbs and vegetables – in a broad range of packet sizes and product forms to meet your needs. Browse the full assortment in our Seed & Plant catalog.

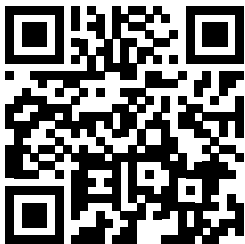

Clonex® Clone Solution

Clonex® Clone Solution is a plant nutrient specifically formulated for rooted clones and seedlings. It contains a special blend of the highest quality minerals including Nitrogen, Phosphorus, Potassium, and Calcium plus other essential elements that all plants require for vigorous growth.

Item #	Desc	UPC	Vendor	CS/UOS	Location
81860076	20ML packet	659627000513	CCSPACKET	18/18	National
81860077	1 Quart	659627009004	CCSQT	12/12	National
81860078	1 Gallon	659627009011	CCSGAL	4/4	National
81860079	2.5 Gallon	659627009028	CCS25GAL	2/2	National

Clonex® Rooting Gel

Clonex® Rooting Gel contains a unique blend of hormones, anti-fungal agents, vitamins, and minerals in a highly tenacious and stabilized gel base. The Clonex® formulation has been fine-tuned to give the explosive root development and for this reason serious growers and plant nurseries depend upon it for successful and profitable plant propagation.



Item #	Desc	UPC	Vendor	CS/UOS	Location
81860068	15ML packet	659627002043	CLOGELPK	108/108	National
81860067	100ML	659627002029	CLOGEL100ML	12/12	National
81860069	250ML	659627002036	CLOGEL250ML	12/12	National
81860074	Gel pint	659627002074	CLOGELPT	6/1	National
81860075	Gel quart	659627002050	CLOGELQT	4/1	National
81860093	Gallon	072532000179	CLOGELGAL	2/2	National
81860096	Mist Conc. Gal	659627000946	CLOMIST-CONGAL	4/4	National

Root Riot™

Ideal for rooting plant cuttings and starting seeds, Root Riot™ cubes provide the perfect environment for root initiation and development. Made from composted natural materials, these plant starter plugs have a great spongy texture which retains the perfect air/water ratio for healthy, rapid root growth. Trays do not contain root riot gel.



Item #	Desc	UPC	Vendor	CS/UOS	Location
81860090	Bag of 50	659627011076	RTRTBAG50	20/20	National
81860089	Bag of 100	659627000513	RTRTBAG100	12/12	National
81860092	Box of 1500	659627000605	RTRTBULK	1/1	National
81860095	Tray of 50	659627011038	RTRTRTRY50	12/12	National



Seed Starter

Specially formulated soilless mix to promote superior germination of seeds. Contains six components blended in proper proportions. Light weight, loose and fertile. Also useful for transplanting or root cuttings.



Item #	Desc	UPC	Vendor	CS/UOS	Location
80070032	4 qt.	071605301014	30101	12/12	East
80070030	10 qt.	071605301038	30103	6/6	East
80070031	18 qt.	071605301182	30118	4/4	East



Dirt Pot Flexible Portable Planters

Featuring porous breathable fabric that is made from 100% recycled water bottles. These planters allow your plants to thrive by promoting exceptional root health and vigorous plant growth. Dirt Pots are stronger than similar products, with reinforced seams and stitching. With handles.



Item #	Desc	UPC	Vendor	CS/UOS	Location
80880032	7 Gal	638104001342	HGDB7	10/10	National
80880029	10 Gal	638104001359	HGDB10	10/10	National

Germination Station w/ Heat Mat & Dome

Germination station with heated mat. Grow healthier starts, increase germination success and better humidity control for optimum growth. Includes UL listed waterproof heat mat, 17 watts/120 volt, 2" humidity dome, 11"x 22" watertight base tray, 72 cell seedling inserts, instructions with growing tips and seed starting booster.



Item #	Desc	UPC	Vendor	CS/UOS	Location
80880006	72 Cell	638104640503	CK64050	12/4	National

Digital Temp Controller for Heat Mat

The heat mat thermostat is digital for greater accuracy. The stainless steel temperature probe can be submerged in water. Digital temperature controller for heat mats. Provides constant optimum temperatures for specific crops. Controls temperature in colder or warmer environments. Illuminated indicator light; 3-prong ground plug. Compatible with all heat mats; optional for hydrofarm Heat Mats. Controllable range from 68 - 108° Fahrenheit. Celsius or Fahrenheit read-out (hold Up or Down button to change). Max current: 8.3 amps / 1000 watts.

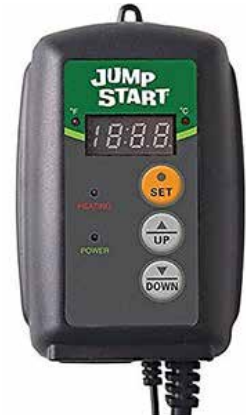

Item #	Desc	UPC	Vendor	CS/UOS	Location
80880005	1000 w	638104100038	MTPRTC	6/1	National

Jump Start Seedling Heat Mat

This windowsill heat mat is perfect for veteran growers, beginners, and children too. It is the perfect size for small growing spaces, and improves germination by warming the root area 10-20°F over ambient temperature. By warming the roots you increase your growing success as this mat will maintain a controlled temperature all season long. UL listed. Power cord included. 120 Volt.



Item #	Desc	UPC	Vendor	CS/UOS	Location
80880001	3"x20" 7.3W	638104000116	MT10004	10/1	National

Seedling Heat Mats

Re-engineered for better performance and greater durability! The new, stronger heating wire, and thicker multi-layer construction offers more uniform heating and the durability to withstand rugged greenhouse environments. Increases success of seedlings and cuttings. Warms root area 10-20°F over ambient temperature to improve germination. Lighting, watering, and planting information printed on mat. Waterproof construction. Has a 6' power cord. The only UL-listed seedling heat mats on the market! 50% thicker construction.

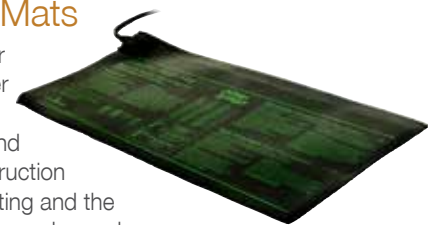

80880002- 8 7/8" x 19 1/2"
80880003- 20" x 20"
80880004- 48" x 20"

Item #	Desc	UPC	Vendor	CS/UOS	Location
80880002	17 Watt	638104100069	MT10006	10/1	National
80880003	45 Watt	638104100083	MT10008	10/1	National
80880004	107 Watt	638104100090	MT10009	6/1	National



Jump Start Grow Light Systems

Ideal for seedlings, cuttings, flowers and house plants. Grow seedlings faster with 15-20% more lumens. Simple toggle clamp for easy lamp height adjustment. Super easy assembly. Internal reflective finish directs more light to plants. CE Certified.



Item #	Desc	UPC	Vendor	CS/UOS	Location
80880202	2' w/timer	638104025669	JSV2T	6/6	National
80880203	4' w/timer	638104025676	JSV4T	6/6	National

Bonsai Shears

The Hydrofarm Bonsai Shears offer precise cutting, making them ideal for bonsai and delicate plant pruning.



Item #	Desc	UPC	Vendor	CS/UOS	Location
80880133	60MM	63810410647	HGBS600	12/12	National

GROW!T Clay Pebbles

GROW!T horticultural clay pebbles are made from 100% natural clay. They are clean, pH stable, and offer great aeration and drainage in hydroponics, especially in flood and drain, deep water culture, and drip feed systems. Due to their unique structure and ability to cover a large surface area, they offer the ideal environment to foster beneficial bacterial growth around the root zone, leading to naturally healthier plants.



Item #	Desc	UPC	Vendor	CS/UOS	Location
80880011	10L	034517150250	GMC10L	91/1	National
80880205	40L	638104013444	GMC40L	80/1	National

Geolite Clay Pebbles

GEOLITE clay pebbles serve as a strong, durable and versatile media, perfect for hydroponics and many horticultural applications. Made from 100% natural Italian clay, this media is industrially produced at extremely high temperatures (2200°F/1200°C) and specially treated for a consistent EC and stable, neutral pH. It offers great aeration and drainage, ensuring success with technically one of the best growing medias for your indoor garden.



Item #	Desc	UPC	Vendor	CS/UOS	Location
80880206	45L	638104013758	GMGC45L	80/1	National



GROW!T Organic Coco Coir



They retain water, making sure plants never go thirsty, but due to their texture, they also offer excellent drainage properties. Plants are no longer at risk of "drowning" in too-packed or over-watered soil. Instead, PlantIt's ideal consistency gives them room to breathe and for roots to grow freely, capturing that essential air-to-water ratio for your biggest growth yet.

Item #	Desc	UPC	Vendor	CS/UOS	Location
80880013	Planting Chips - 2 cu. ft.	638104002554	JSCC2	1/1	National
80880015	Mix - 2.5 cu. ft.	638104002547	JSCCM25	1/1	National
80880016	Mix Brick - 3 Pack	638104006804	JSCPB	5/5	National

Roots Organics Formula 707

A ready-to-use soil created for a special kind of gardener, those who want to control their own destiny. Formula 707 is different from the other growing mixes created by Aurora Innovations. It was designed with greater water-holding capacity, fewer nutrients, less perlite and less pumice, and it contains ingredients specific to large container gardening. In fact, the packaging is a 30 gal. grow bag containing about 20 gal. of the finest quality potting mix. Just punch holes in the bottom, cut off the top and plant.



Item #	Desc	UPC	Vendor	CS/UOS	Location
81270173	1.5 cu. ft.	609728631901	RO7071.5	70/70	East
81270001	3 cu. ft.	609728631895	RO707	36/36	East

Original Potting Soil

Roots Organics Original is a ready to use mix created with a balanced air to water ratio of porosity and water retention to allow for frequent feeding of fast growing, heavy feeding plants.



Item #	Desc	UPC	Vendor	CS/UOS	Location
81270002	1.5 cu. ft.	609728631857	ROD	70/70	East



Agrosun® Dayspot Incandescent Bulb 60W

Full daylight spectrum incandescent grow bulbs. Bulbs can be used in any fixture. One year warranty.



Item #	Desc	UPC	Vendor	CS/UOS	Location
80880040	60 Watt	638104104135	BURP413	12/12	National

Dayspot Grow Light Kit

Maintains healthy growth. Convenient spot lighting for plants. Overwinter light-loving plants.



Item #	Desc	UPC	Vendor	CS/UOS	Location
80880022	150w	638104101516	LKIT150	4/4	National
80880023	60w	63810400601	LKIT60	6/6	National



Mondi 7" Mini Greenhouse

Regulates air flow with two adjustable vents that allow you to adjust temperature and humidity, better results for the garden. Heavy duty 7" vertical design fits tightly onto standard 10" x 20" flats, reducing moisture loss, while giving more cubic volume for plants. 7 1/2" H X 11" W X 2 1/4" L

Item #	Desc	UPC	Vendor	CS/UOS	Location
80880141	7" Dome	638104640909	MONDIG100	50/50	National



Vented Dome

These domes fit directly onto the standard 10 x 20" cut kit trays to create a humid and warm environment ideal for cuttings and seed germination. Tall 7.5" dome gives extra height for your taller cuttings. Adjustable vents allow for perfect humidity and temperature control. 22.0"L x 11.3"W x 7.8"H

Item #	Desc	UPC	Vendor	CS/UOS	Location
80880044	7.5" Dome	638104010566	CK64081	25/25	National

Precision Lightweight Pink Pruner

These lightweight anti-fatigue pruners are based on our immensely popular classic Hydrofarm pruners, favored by legions of horticulturists. Their surgical stainless steel blades offer serious cutting capacity in a lightweight package.

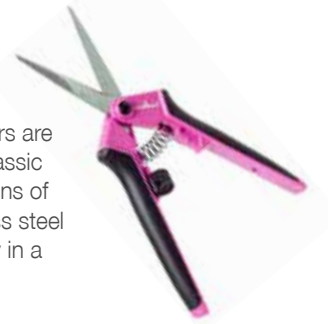

Item #	Desc	UPC	Vendor	CS/UOS	Location
80880158	Pink Pruner	638104021470	HGPL400P	12/12	National



The Jack's FeED line is comprised of complete nutrient formulations. Everything your plants need for each stage, from start to finish.

5-12-26 Part A

An improvement on the classic "Part A" formula for general vegetative growing. This redesigned blend is built with purely soluble and available nutrients to allow the grower maximum flexibility. Specific balance of macro, secondary and micronutrients delivers an efficient combination of nutrients suitable for many different growing environments and crop types.



Item #	Desc	UPC	Vendor	CS/UOS	Location
80060046	2.2 lb.	671341790310	79031	6/6	National

12-4-16

For the Purest in you. This one part nutrient blend is designed for crops grown in very low alkalinity waters such as reverse osmosis (RO) water, rainwater, and distilled water. Formulated utilizing the innovative raw materials to reduce pH crash while delivering all the nutrients essential for vigorous plant growth.



Item #	Desc	UPC	Vendor	CS/UOS	Location
80060047	2.2 lb.	671341790419	79041	6/6	National



JACK'S NUTRIENTS LINE

SOLUBLE. AVAILABLE. CONSISTENT.

Since 1947, these are the three words that you have come to expect when you open a bag of fertilizer made by the Peters' Family - and now, the master-crafters at Jack's introduce our small batch blends, Jack's Nutrients: A collection of formulas that gives you choices that work for many different controlled environments without the hype or confusion of extravagant names and crazy labels.



2024

15-5-20

Allow your plants to drink up this formula designed to provide all the macro, secondary and micro nutrients in a one-part system. Specifically formulated for tap, city or well water types with slightly higher alkalinity & pH. This combination of nutrients will lower pH over time while including the extra soluble calcium, magnesium and the right balance of micronutrients.

Item #	Desc	UPC	Vendor	CS/UOS	Location
80060048	2.2 lb.	671341790518	79051	6/6	National

10-30-20 Bloom

Need a Boost of Flower Power? Our 1:3:2 major nutrient ratio has been trusted by Jack's Professional growers for over 70 years. This soluble and available nutrient combination stimulates blooming, resulting in heavy bud and fruit set.

Item #	Desc	UPC	Vendor	CS/UOS	Location
80060049	2.2 lb.	671341790617	79061	6/6	National

15-6-17 Clone

Like a shot gun start for your new plants - this formula will help promote strong and fast root growth and expansion. Best used for fertilizing young seedlings, transplants, clones and newly set rooted cuttings.

Item #	Desc	UPC	Vendor	CS/UOS	Location
80060050	2.2 lb.	671341790716	79071	6/6	National

5-50-18 UltraViolet

Get ready for a serious boost of available phosphorus. The primary goal of this formula is to assist in shutting down the strong vegetative growth stage of the plant and stimulate a switch to the reproductive or flowering phase of plant and flower development.

Item #	Desc	UPC	Vendor	CS/UOS	Location
80060051	2.2 lb.	671341790112	79011	6/6	National

7-15-30 Finish

You've always been told to finish strong. This formula is ideally formulated for this purpose to provide your plants with a very low nitrogen, high phosphorus and very high potassium content to keep the whole plant happy to the end of its crop cycle.

Item #	Desc	UPC	Vendor	CS/UOS	Location
80060053	2.2 lb.	671341790211	79021	6/6	National

0-12-26 Part A

Zero nitrogen formula delivers a proven ratio of P and K to achieve harvest goals. Designed to follow the Part A system of nutrient delivery. This purely soluble and available formula keeps secondary and micronutrients consistent at each feeding.

Item #	Desc	UPC	Vendor	CS/UOS	Location
80060064	2.2 lb.		79231	6/6	National



The Jack's Boost line is all the little extras your plants may need. Do you need calcium or extra nitrogen? These supplements and more are found in the Jack's Boost Line.



15-0-0 Cal Nit Part B

An essential "Part B" provides a very soluble and available source of calcium in a two-part nutrient system. Contains very pure and completely available calcium and nitrate nitrogen nutrient sources.

Item #	Desc	UPC	Vendor	CS/UOS	Location
80060052	2.2 lb.	671341790815	79081	6/6	National



Natural & Organic Starter Mix

A premium seed starter soil that contains the ingredients of Canadian Sphagnum Peat Moss and Wood Pulp.



Item #	Desc	UPC	Vendor	CS/UOS	Location
81870052	10 qt.	33349056186	G310	8/8	National
81870053	16 qt.	33349416201	G316	3/3	National



Seed Starter Greenhouse Trays

Dimensions: 2.5"H x 21"W x 10.8"D. Sturdy base tray is reusable and recyclable. Includes tray and pop out cells.

Item #	Desc	UPC	Vendor	CS/UOS	Location
81870077	72 cell	33349660093	T72HST-14	14/14	National



Greenhouse Kit

Our highest pellet count in a kit, this greenhouse is perfect for starting your garden indoors. As a bonus, get your seedlings started off strong with a sample of SUPERthrive, a kelp-based vitamin for plants!

Item #	Desc	UPC	Vendor	CS/UOS	Location
81870082	36mm -72 Cell	33349660406	J372PROGS	20/20	National



Greenhouse Kit

Ideal for greenhouse project for growing flowers and vegetables. Square peat pots ensure enough space for tender roots.

Item #	Desc	UPC	Vendor	CS/UOS	Location
81877174	50cell Peat	20033349660103	TS50HST8	8/8	National



Windowsill Greenhouse

Convenient no mess way to start seed, just add water, pellet expands to form pot and soil in one. Includes watertight tray and humidity dome. Great space saver.

Item #	Desc	UPC	Vendor	CS/UOS	Location
81870081	36mm 12cell	33349660376	J312G	17/17	National



Gro-Dome & Tray

Gro-Dome fits most 11" x 22" trays

Tray and Dome are sold separately.

Item #	Desc	UPC	Vendor	CS/UOS	Location
81870030	Dome	33349412210	TDOME	50/50	National
81870031	Tray	33349412340	TTRAY	50/50	National

Wildflower Shaker Bags

Wildflower seed shaker bags. Choose from a pollinator mix or a sunny meadow mix. One bag covers up to 500 sq ft.



Item #	Desc	UPC	Vendor	CS/UOS	Location
81870065	Pollinator	071953965265	WFPOL18	18/18	National
81870067	Sunny	011192603788	WFSU18	18/18	National

Peat Pellet Bulk Packs

Bulk contains 1,000 42mm peat pellets. Sold as bulk pack only.



Item #	Desc	UPC	Vendor	CS/UOS	Location
81870019	42 mm	033349007010	J3BULK	1/1	National



Peat Pellet Refills

Item #	Desc	UPC	Vendor	CS/UOS	Location
81870026	25 peat pellets 42mm per pack	33349077501	J4REFILL	29/29	National

Peat Pots



Item #	Desc	UPC	Vendor	CS/UOS	Location
81870041	2 round 12 pack	33349412111	JP212	44/44	National
81870043	3 round 10 pack	33349031107	JP310	37/37	National
81870042	2 round 26 pack	33349412142	JP226	16/16	National
81870046	4 round 6 pack	33349414443	JP406	28/28	National
81870044	3 round 22 pack	33349413187	JP322	18/18	National
81870048	5 round 6 pack	33349050825	JP506	16/16	National

Strips

Four 8ct trays can plant up to 32 plants



Item #	Desc	UPC	Vendor	CS/UOS	Location
81870049	2.5" sq	033349412548	JS32	20/20	National



Jobe's® Food Spikes

Spikes provide a continuous supply of important nutrients right at the roots, where plants need it most. The premeasured, specially formulated spikes are simply inserted into the soil around your plant. Unlike liquids or granular, Jobe's Houseplant Spikes eliminate mess, hazards and smells – and can't wash through when you water. 50 spikes per package.



Item #	Desc	UPC	Vendor	CS/UOS	Location
80180028	House plant 13-4-5: 50 Pack	073035250016	05031T	18/18	National
80180029	Flowering plant 10-10-4: 50 Pack	073035252010	05231T	18/18	National



Jobe's® Potted Plant & Hanging Basket Spikes 6-18-6

Slow release formula feeds roots for vigorous growth and large, beautiful blooms. Feeds for up to eight weeks. 18 spikes each.

Item #	Desc	UPC	Vendor	CS/UOS	Location
80180149	Blister Pk	073035061483	6100	12/12	National
80180027	Pouch	073035061056	6105	24/24	National



Seed & Cutting Mix

Lambert Seed & Cutting Mix plays a big part in successfully completing the process of germination. It drains well and easily fills seedling trays. This media works very well in anchoring unrooted cutting, surrounding the stem with a substrate that also provides moisture and encourages root formation.



Item #	Desc	UPC	Vendor	CS/UOS	Location
81940019	8 qt	066498076101	6649807610	6/6	East
81940042	16 qt	066498076118	6649807611	120/6	East



Copper Label

Long-lasting copper and zinc labels for labeling like the professionals. Weather resistant packaging. 4 per pack. 12 packs/case.



Item #	Desc	UPC	Vendor	CS/UOS	Location
80140108	6" 4pk	035307008619	861	12/12	National

Zinc Label

Long-lasting zinc labels for labeling like the professionals. Weather resistant packaging.



Item #	Desc	UPC	Vendor	CS/UOS	Location
80140109	6" 4pk	035307008626	862	12/12	National
80140116	10" 10pk	035307007827	782	12/12	National

Dial Seed Sower

Provides for the even distribution of seeds with a convenient six-setting rotary dial for different seed sizes. Easily vibrates garden seed to soil. Helps make straight rows.



Item #	Desc	UPC	Vendor	CS/UOS	Location
80140090	12per case	035307008039	803	12/12	National

Rapiclip® Mini Seedmaster

Makes sure small seeds are planted exactly where you want them with this small plunger-type dispenser.



Item #	Desc	UPC	Vendor	CS/UOS	Location
80140092	Seeder	00353078053	805	12/12	National

Wood Plant Labels

Clearly label all your seeds and plants for easy identification. Each pack contains 24 wood plant labels. 12 packs/case.



Item #	Desc	UPC	Vendor	CS/UOS	Location
80140095	6" 24pk	035307008121	812	12/12	National

Luster Leaf Plant Labels

Luster Leaf's labels are for all applications. Clearly label all your seeds and plants for easy identification.



Item #	Desc	UPC	Vendor	CS/UOS	Location
80140103	4" 50pk	035307008275	827	12/12	National
80140102	6" 25pk	035307008268	826	12/12	National
80140105	6" 50pk	035307008404	840	12/12	National
80140107	8" 30pk	035307008435	843	12/12	National

"T" Labels

This plant marker is easy to label with seed packet or write on label area.



Item #	Desc	UPC	Vendor	CS/UOS	Location
80140099	6" 10pk	035307008206	820	12/12	National
80140098	8" 10pk	035307008183	818	12/12	National
80140097	13" 5pk	035307008176	817	12/12	National

Coco Coir Brick

Premium seed starter mix an ideal growing medium for organic applications.



Item #	Desc	UPC	Vendor	CS/UOS	Location
80140205	1.4 LB	35307012500	1250	12/12	East



NoDampOff™ Organic Seed Starting Medium

Amazing seed germinating medium for all types of seeds, bulbs, and plants. Mother Nature's surest and safest starting medium for almost 100% seed germination. Eliminates damping off disease. No chemical protectants nor sterilization required. Less over-watering danger. Produces tremendous root systems. Growth rate can be controlled by regulating fertilization.



Item #	Desc	UPC	Vendor	CS/UOS	Location
80130025	2 Bushel Sack	10367000025	ML0002	1/1	East

Sucseed Seed Starter

Milled long fibered sphagnum moss has been recommended by professionals as the only renewable seed starter. Made from Wisconsin-grown long fibered sphagnum moss plant, SucSeed® is free of peat, which can contain harmful damping-off bacteria that could kill your seedlings. SucSeed® Seed Starter gives your seeds the best chance of achieving the highest seed germination rate available.



Item #	Desc	UPC	Vendor	CS/UOS	Location
80130071	222 cu. in. bags	010367000032	ML0003	12/12	East

Mossify™



LED Plant light Adjustable

Our Adjustable LED Plant Light is an energy-efficient LED light ideal for a wide variety of houseplants. With a programmable timer, you can ensure your plants receive the perfect amount of light throughout the day, while the 5-level dimmable feature allows you to customize the light intensity to suit plants' unique requirements. This light can also be extended from 8 inches to 28 inches, making it suitable for plants of different sizes and stages of growth.

Item #	Desc	UPC	Vendor	CS/UOS	Location
82370047	28" White	676307771129	PLNLT-0001	12/12	National
82370048	28" Black	660111997042	PLNLT-0002	12/12	National



Coco Coir Pot

100% natural and biodegradable coconut fibers; sustainably made from the fibers harvested from coconut shells; ideal for seed starting and fast and easy germination.



Item #	Desc	UPC	Vendor	CS/UOS	Location
81910016	2.5" 12pk	770932039408	3488	24/24	East
81910017	3.25" 8pk	770932048400	3489	24/24	East
81910021	3.25"	10770932001860	3032	1540/1540	East
81910023	4"	20775578461525	3141	1344/1344	East
81910022	4.25"	20775578461518	3072	1032/1032	East
81910031	4.25" sq.	20775578461594	3136	600/600	East
81910024	4.5"	20775578461532	3033	660/660	East
81910018	4.5" 6pk	770932040411	3490	24/24	East
81910026	5"	60775578460519	3090	320/320	East

Vented High Dome

Help maintain moisture for plants. Fits 10 x 20 tray. Adjustable sliding vent allows you to control humidity levels within the 6" H dome.



Item #	Desc	UPC	Vendor	CS/UOS	Location
81910047	6" 10x20	770932108005	3461	18/18	East

Professional Humidity Dome

Fits 10x20 greenhouse tray



Item #	Desc	UPC	Vendor	CS/UOS	Location
81910044	10x20	770932108098	4062P-A	48/48	East

Self Watering System Kit

Item #	Desc	UPC	Vendor	CS/UOS	Location
81910005	28-2.5" Coir Pots	770932002938	3459	6/6	East



Coir Pellet Greenhouse Kit

The Jumbo 42mm Coconut Coir Pellets are perfect for all-purpose use and come with a professional greenhouse tray and a humidity dome.



Item #	Desc	UPC	Vendor	CS/UOS	Location
81910006	10-42mm plts	770932007070	3259	24/24	East



Coir Pot Strips

Coir based growing containers are designed to offer you all the benefits of peat, without destroying our peat bogs. Much higher resistance to mold. Visibly better, faster plant growth. Containers won't fall apart when wet. Won't pull moisture away from plant.

Item #	Desc	UPC	Vendor	CS/UOS	Location
81910003	1.75" 50cells	770932004420	3450	24/24	East
81910004	2.5" 32cells	770932004413	3451	24/24	East

Greenhouse Kit

Coconut Coir Pots are more durable when compared to peat pots. They are also resistant to mold growth. Kits include 100% Organic Coconut Coir pot strips, professional greenhouse tray and humidity dome.



Item #	Desc	UPC	Vendor	CS/UOS	Location
81910002	16-2.5" coir cell GH Kit	770932055408	3449	12/12	East
81910040	36-1.75" plastic cell GH Kit	770932553027	3455	12/12	East
81910001	50-1.75" coir cell GH Kit	770932054425	3448	7/7	East
81910039	50-1.75" plastic cell GH Kit	770932503022	3454	7/7	East

Coir Pellet

Coir pellets allow the root system to soak up more oxygen, liquid and nutrients compared to peat pellets.



Item #	Desc	UPC	Vendor	CS/UOS	Location
81910008	50-42mm coir pellet GH Kit	770932005816	3261	20/20	East
81910012	50-42mm coir pellet refill	770932043436	3492	12/12	East



PlantBest Seed Starting Pallet

- (7) 50 Coconut Coir Pot Greenhouse Kit
- (14) 16 Coconut Coir Greenhouse Kit
- (6) 28 Coconut Coir Pot Greenhouse Kit
- (20) 50 42mm Coconut Pellet Greenhouse Kit
- (48) 2.50" Biodegradable Coconut Coir Pot 12/pack
- (54) 3.00" Biodegradable Coconut Coir Pot 8/pack
- (12) 4.50" Biodegradable Coconut Coir Pot 6/pack
- (7) 72 Cell Plastic Greenhouse Kit
- (14) 36 Cell Plastic Greenhouse Kit
- (72) 50 42mm Coconut Coir Pellet Refill + Cardboard Displayer

Item #	Desc	UPC	Vendor	CS/UOS	Location
81910056	1/2 Pallet	50775578461472	3486	1/1	East

PRO-MIX

PRO-MIX Premium Organic Seed Starting Mix

OMRI-Listed and Ready-to-use, this peat-based organic seed starting mix is specially formulated with all natural ingredients. It's ideal for germinating, vegetable, flower, herb seeds as well as for starting leaf, stem or root cuttings. MycoActive™ Organic Growth Enhancer helps grow stronger roots, which leads to healthier plants with greater resistance to transplant shock.



Item #	Desc	UPC	Vendor	CS/UOS	Location
80310031	16 qt.	025849110413	1016041RGCE	210/6	East





African Violet Plus™ Liquid Plant Food 8-14-9

Promotes beautiful African violet blooms. Just 7 drops per quart of water. Package contains easy to use dropper and directions. Contains micronutrients.



Item #	Desc	UPC	Vendor	CS/UOS	Location
80050064	4 oz.	089146901068	SPF44900	12/12	National

Plant Food Plus™ 10-15-10

For all indoor and outdoor plants. Encourages new growth. Easy to use 7 drops per quart of water. Contains micronutrients and easy to measure dropper.



Item #	Desc	UPC	Vendor	CS/UOS	Location
80050062	4 oz.	089146901075	SPF45160	12/12	National
80050063	8 oz.	089146901082	SPF45170	12/12	National

Cactus Plus™ Liquid Plant Food

4 oz. Schultz® Cactus food makes feeding easier. Place 7 drops in one quart of water to feed every time you water. Good for all Cacti and other Succulents, Jade, and Aloe Vera. Feeds through the roots. Contains micronutrients.



Item #	Desc	UPC	Vendor	CS/UOS	Location
80050086	4 oz.	089146901044	SPF44300	12/12	National

Liquid Plant Shine

Schultz Original 12oz Plant Shine leaf polish promotes shiny leaves. Because it's water-based and contains no oils, it will not clog plant pores and instead allows plants to breathe. It's easy to use, with a simple spray application.



Item #	Desc	UPC	Vendor	CS/UOS	Location
80050088	12 oz.	089146901105	SPF44000	8/8	National



Multipurpose Fabric Planter

Item #	Desc	UPC	Vendor	CS/UOS	Location
81110001	3 Gal	674344110031	11003	12/12	National
81110003	5 Gal	674344110055	11005	12/12	National
81110188	3 Gal w/ Handles	674344210038	21003	12/12	National
81110004	5 Gal w/ Handles	674344210052	21005	12/12	National

7 Gallon Salad & Herb Grower w/ Cut Handles



Item #	Desc	UPC	Vendor	CS/UOS	Location
81110006	7 Gal w/ Handles	674344210076	21007	12/12	National
81110005	7 Gal	674344110079	11007	12/12	National



Smart Pot Black Bulk

Soft sided fabric container. Multi purpose, aeration container for growing great plants. Provides root pruning. Excellent drainage & releases excess heat in hot weather for superb, fibrous root systems. For growing vegetables, flowers, herbs, and fruit. Lasts for years. Can be left outside all year long without worrying about winter damage.

Item #	Desc	UPC	Vendor	CS/UOS	Location
81110042	1 Gal	674344100018	10001	100/100	East
81110046	3 Gal	674344100032	10003	50/50	East
81110049	5 Gal	674344100056	10005	50/50	East
81110051	7 Gal	674344100070	10007	50/50	East
81110053	10 Gal	674344100100	10010	50/50	East
81110055	15 Gal	674344100155	10015	50/50	East
81110059	25 Gal	674344100254	10025	50/50	East



10 Gallon Pepper & Veggie Grower w/Cut Handles



Item #	Desc	UPC	Vendor	CS/UOS	Location
81110008	10 Gal w/ Handles	674344210106	21010	12/12	National

15 Gallon Potato & Squash Grower w/ Strap Handle



Item #	Desc	UPC	Vendor	CS/UOS	Location
81110010	15 Gal w/ Handles	674344210151	21015	12/12	National

20 Gallon Tomato & Melon Grower w/ Strap Handle



Item #	Desc	UPC	Vendor	CS/UOS	Location
81110012	20 Gal w/ Handles	674344210205	21020	12/12	National

Raised Bed Planter

No construction required.
Unfold - Fill - Plant



Item #	Desc	UPC	Vendor	CS/UOS	Location
81110137	10.7 cu. ft.	674344122065	12306	10/10	National



Sunshine® Advanced Mix #4 with Resilience™

Recommended for indoor growing. This Myco-Active mix retains moisture while providing improved root aeration and drainage. This product contains Resilience™ for stronger stems and improved root mass.



Item #	Desc	UPC	Vendor	CS/UOS	Location
80320114	3 cu. ft.	064277310309	504500.CFC003P	35/35	East

Black Gold Seedling Mix

This highly refined, organic seedling mix is excellent for root growth in newly germinated seedlings, has low-salt, and is fine, yet porous and water-retentive. It has an organic wetting agent to ensure uniform water penetration. This product contains Resilience for stronger stems and improved root mass.



Item #	Desc	UPC	Vendor	CS/UOS	Location
80320031	8 qt	029973123332	1411002.Q08P	8/8	National
80320032	16 qt	029973123417	1411002.Q16U	4/4	National



Superthrive Vitamin Solution

Superthrive is a highly concentrated non-toxic vitamin solution invigorating all variety of greenery for home gardeners and professionals alike. It is equally suited for hydro-seeding, hydroponics, and foliar spraying. Superthrive maximizes potential by quickly building a strong root base and reducing transplant shock.

Item #	Desc	UPC	Vendor	CS/UOS	Location
81870002	4 oz.	072532000148	ST4-12	12/12	National
81870003	1 pt.	072532000155	STPINT-12	12/12	National
81870004	1 qt.	072532000162	STQUART-12	12/12	National
81870005	1 gal.	072532000179	STGALLON-4	4/1	National



Soil Moist™ Mycorrhiza Container Mix Plus

Contains beneficial endo-mycorrhizal fungi from 7 species that are adapted to a wide range of plants and habitat conditions. An 8-9 month timed release fertilizer and Soil Moist™ water storing polymer is included. The ultimate choice for planting flower boxes, hanging baskets & patio pots. Treats 20-1 gal containers, or up to 50 sq. ft.



Item #	Desc	UPC	Vendor	CS/UOS	Location
80040214	8 oz.	030541000696	JCD-05CMP	12/12	National

Soil Moist™ Flower & Garden Plus

Contains beneficial endo-mycorrhizal fungi from 7 species that are adapted to a wide range of plants and habitat conditions. An 8-9 month timed release fertilizer & Soil Moist water storing polymer is included in the mix. Ideal for planting in flower beds and gardens. Treats 40-1 gal. pots or 100 sq.



Item #	Desc	UPC	Vendor	CS/UOS	Location
80040212	1 lb.	030541000672	JCD-100FGP	6/6	National

Soil Moist™ Plus Spikes 5-5-5

Contains the Soil Moist™ copolymer blended with a three to four month timed release fertilizer. Ideal for indoor/outdoor plantings, especially in warmer, drier climates.



Item #	Desc	UPC	Vendor	CS/UOS	Location
80040007	24 pk display	030541010107	JCD-024SMP	24/24	National
80040014	12 pk display	030541010107	JCD-012SMP	12/12	National
80040008	24 pack clear spikes no fertilizer	030541012101	JCD-024SMS	24/24	National

Soil Moist™ Plant Paks

Now, no measuring, no mess! Plant Paks make it even more appealing by providing pre-measured Soil Moist™ in biodegradable “drop-in bags.” Now plant watering and feeding couldn’t be easier, quicker or neater.



Item #	Desc	UPC	Vendor	CS/UOS	Location
80040026	Shelf Unit	030541466881	SMP	12/12	National

Soil Moist™ Plus 7-7-7

Contains the Soil Moist™ copolymer blended with a three to nine month timed release fertilizer. Ideal for indoor/outdoor plantings, especially in warmer, drier climates.



Item #	Desc	UPC	Vendor	CS/UOS	Location
80040017	8 oz.	030541010855	JCD-05SMP	12/12	National

Soil Moist™

Soil Moist has been developed to reduce the amount of watering needed to maintain vigorous, healthy plants. Soil Moist is safe to use in all landscape and gardening situations, including vegetable gardens. When mixed in the soil, the Soil Moist crystals will soften and swell as water is added and absorbed. The polymer acts as a water reservoir, releasing water to the plant as the surrounding soil dries.



Item #	Desc	UPC	Vendor	CS/UOS	Location
80040001	1 lb.	030541010305	JCD-100SMJ	6/6	National
80040002	3 lb.	030541010343	JCD-030SM	6/6	National
80040004	3 oz. Display	030541010206	JCD-012SM	12/12	National
80040005	3 oz. Display	030541010206	JCD-024SM	24/24	National
80040006	8 oz.	030541010398	JCD-05SM	12/12	National

Soil Moist™ Mats

The mats reduce plant waterings as they slowly release water back to the plant roots. Simply add the mat towards of the pot, add soil and add plant. Works great in hanging baskets too!



Item #	Desc	UPC	Vendor	CS/UOS	Location
80040009	7"x7" Mat	030541088786	SMMS	12/12	National

Soil Moist™ Vacation Mats

Soil Moist Vacation Mats contain water storing polymer woven into a cloth for interior plants to reduce waterings. Simply place your house plants on the mat and through capillary action, plants are watered for up to three weeks. There are two 15 3/4"x 11" mats per pack.



Item #	Desc	UPC	Vendor	CS/UOS	Location
80040022	Vacation Mats	030541088793	SMVS	12/12	National



T5HO Combo's (A)

SunBlaster T5HO Combos include our T5HO electronic ballast, 6400K lamp, power cord with on /off switch, and jumper plug with both hanging and flat surface mounting clips. Also included is the NanoTech T5 Reflector which spreads light wider across the plant canopy, penetrating deeper into the plant foliage, without consuming any additional power.

Item #	Desc	UPC	Vendor	CS/UOS	Location
81740038	24" 24W	628836093029	900302	6/6	National
81740040	48" 54W	628836093043	900304	6/6	National

T5HO Lighting Kit (B)

The T5HO Light Kits come standard with a 6400K grow lamp, power-cord with on/off switch, 14" link cord, flush mount and hanging clips included.

This Kit is great for propagation of seedlings, cutting or getting your plants started right from seed. The 6400K grow lamp will also grow to finish many leafy green products , baby greens and all kinds of herbs.

Item #	Desc	UPC	Vendor	CS/UOS	Location
81740017	24" 24W	628836091728	900172	6/6	National
81740019	48" 54W	628836091742	900174	6/6	National

1020 Double Thick Tray

HEAVY DUTY 1020 Propagation Trays. Twice the thickness of traditional trays! These trays are re-usable. These are industry standard size: 10" x 20".



Item #	Desc	UPC	Vendor	CS/UOS	Location
81740058	No holes	628836142208	1400220	50/50	National



LED Strip Lights (C)

SunBlaster LED Strip Lights are designed to maximize overall performance, economy, and extend longevity while providing the best possible lighting for all indoor growing applications without fail or compromise.

SunBlaster Strip Lights run virtually silent, and are mercury free. SunBlaster LED Strip Lights maximize their output without creating unwanted heat, or wasting valuable electronic resources.

Item #	Desc	UPC	Vendor	CS/UOS	Location
81740053	24" 24W 48 LEDs	628836097027	900702	6/6	National
81740055	48" 48W 96 LEDs	628836097041	900704	6/6	National

T5HO Replacement Lamp (D)

SunBlaster T5HO replacement lamps are the right choice when re-lamping your T5HO lighting fixtures. We recommend changing your lamps 10,000 hours of operation to insure maximum growing performance and results from your T5HO lighting system.

Item #	Desc	UPC	Vendor	CS/UOS	Location
81740020	24 W	628836091759	900175	6/6	East
81740022	54 W	628836091773	900177	6/6	East

1020 Quad Thick Tray

SunBlaster created the Worlds first Super Heavy Duty 1020 propagation tray to assist growers in achieving maximum output for their growing efforts.

This high quality injection molded tray is four times the thickness of industry standard 1020 trays.



Item #	Desc	UPC	Vendor	CS/UOS	Location
81740064	No holes	628836142352	1400235	25/25	National

2024

SUNBLASTER
HORTICULTURAL LIGHTING



Micro - Grow Light Garden

Micro Grow Light Garden is perfect for growing salads and herbs or for early season seed starting. Just assemble then add your favorite starting mix, seeds or starter plants of your choice, water and you will be growing in no time. The Growlight Gardens come complete with T5HO lighting kits and reflectors, four seedling trays, wicking mat and platform to keep your plants automatically watered. EA Unit 21"WX8.5"HX5.25"D

Item #	Desc	UPC	Vendor	CS/UOS	Location
81740070	Micro Black	628836161988	1600198	1/1	National
81740071	Micro White	628836161995	1600199	1/1	National

LED versions available

Universal Strip Light Stand

The Universal Strip Light Stand allows you to set the exact lighting height to get your seedlings or fresh cuttings off to their best Starts ever. Simple adjustment makes setting the correct height quick and easy. As your seedlings or starts get growing you simply slide your lighting upwards to the desired height. Works with T5HO or LED Strip Lights.



Item #	Desc	UPC	Vendor	CS/UOS	Location
81740006	Stand only	62883609050	900095	1/1	National

T5HO/LED - Mini Greenhouse Kits

Includes our 18 inch SunBlaster TSHO/LED Combo - light and reflector (not included with LED kit), 6400K Grow Lamp, Double Thick 1020 tray, and 7 inch NanoDome with ingenious light tracks. There simply is no better or faster way to get growing fresh micro-greens, herbs or seeds started ready for transplant.



Item #	Desc	UPC	Vendor	CS/UOS	Location
81740074	LED Kit	628836162046	1600204	1/1	National
81740075	T5HO Kit	628836162053	1600205	1/1	National

Garden Grow Light

The Growlight Garden comes to you as a complete ready to grow garden. Just assemble then add your favorite starting mix, seeds or starter plants of your choice, water and you will be growing in no time. Its just that easy! The Growlight Gardens comes complete with T5HO lighting kits and reflectors, four seedling trays, wicking mat and platform to keep your plants automatically watered. The Growlight Garden has two 24" SunBlaster T5HO Combos for lighting. Available in Black only. 24"WX17"HX14"D



Item #	Desc	UPC	Vendor	CS/UOS	Location
81740072	Black	628836162008	1600200	1/1	National

LED version available

7" NanoDome

A lot of thought went into our 7" NanoDome. This is a high humidity vented dome that incorporates our ingenious light tracks. These tracks receive our T5HO Combo or LED strip lights. By placing your lighting in these tracks your plants receive the light they need. Fits 10" x 20" trays. Light & Tray not included.



Item #	Desc	UPC	Vendor	CS/UOS	Location
81740063	Nanodome	628836142321	1400232	25/25	National



Angled Marker

The Angled T-label is great for placing near or on the ground for easier viewing. Optional black base is also available and fits all T-label stems.



*must order base separately

Item #	Desc	Vendor	CS/UOS	Location
82060018	2-1/2"	SL400W	50/50	National
82060023	3-7/8"	SL500W	25/25	National
82060027	Base	BASE	25/25	National



Plastic Label Markers

Item #	Desc	Vendor	CS/UOS	Location
82060004	3.5" x 2"	SL200W	100/100	National
82060011	3" x 4-1/4"	SL445W	50/50	National



Black Sign Holder

Tyne classic black sign holders are made of a sturdy UV resistant, black plastic. Securely holds 11" x 7" or 5" x 7" signs in place. Angled Single Face style supports one sign in an upward facing position. Complete with 22" stem

Item #	Desc	Vendor	CS/UOS	Location
82060071	Angled single face 7"x5" with base & 22" stem	SL904	50/50	National
82060073	Angled single face 11"x7" with base & 22" stem	SL911	25/25	National
82060076	Cart clip on 11"x7" holder	SL605	25/25	National

Plastic Labels



Item #	Desc	Vendor	CS/UOS	Location
82060028	4"	TY4W	1000/1000	National
82060031	5"	TY5W	1000/1000	National
82060039	6"	TY6W	1000/1000	National
82060040	8"	TY8W	500/500	National



Vinyl Loop Lock Labels



Item #	Desc	Vendor	CS/UOS	Location
82060046	white 5/8" x 6 1/2"	LL625W	1000/1000	National
82060047	yellow 5/8" x 6 1/2"	LL625Y	1000/1000	National

Blackboard Label

These unique labels are ideal for marking sale items. Also a very economical style - use ordinary chalk or liquid chalk and simply wipe clean to re-use!



Item #	Desc	Vendor	CS/UOS	Location
82060057	4" x 6 3/8"	SL500BB	25/25	National

Gardman Mini Greenhouses

Tiered mini greenhouses with reinforced poly covers.

Dimensions: A - 5'3" x 2'3"x 1'6" / B - 3'11" x 1'6" x 5'3"

7610- 4 tier comes with a reinforced cover. Metal tubular frame. Quality construction and materials to last many seasons. Heavy-duty reinforced polyethylene cover. Roll-up zippered door for easy access. (as shown in picture)

Item #	UPC	Vendor	CS/UOS	Location
81730004	A 745487976102	7610	1/1	East
81730003	B 745487976003	7600	1/1	East

2024



Perennials



Perennials



Sunny Annuals



Shade Annuals



Herb Garden



Vegetables



Poinsettias

Pre-designed Poster Options

- 2 sided printing on Coroplast
- Full color print
- UV coated
- Grommets for easy hanging (24x36)

16" x 24"

Item	Description
PP-1623PE	Perennials
PP-1623PO	Poinsettias
PP-1623SH	Shade Annuals
PP-1623SU	Sunny Annuals
PP-1623VG	Vegetables
PP-1623HG	Herb Garden

24" x 36"

Item	Description
PP-2436PE	Perennials
PP-2436PO	Poinsettias
PP-2436SH	Shade Annuals
PP-2436SU	Sunny Annuals
PP-2436VG	Vegetables
PP-2436HG	Herb Garden

POINT OF PURCHASE SIGNAGE

from Griffin

High-quality signage, at affordable prices, with NO minimums! Available in pre-designed and custom options!

FREE DESIGN WORK

ON ALL CUSTOM ORDERS!

Custom Coroplast Posters

- Printed in UV cured ink/long-lasting durability
- Full color bleeds
- Durable high-quality outdoor 4mm coroplast
- Shipped within 5 days of proof approval
- Custom sizes available

Options

- Grommets in top corners - Free
- Double Sided - Additional cost, same as front or new image

Step stakes available
Item # PP-SS

Custom Vinyl Banners

- Printed in true digital color
- Full color bleeds
- Durable high-quality outdoor 13oz scrim vinyl
- Reinforced on all 4 sides with banner welding
- Drop-shipped within 5 days of proof approval

Options

- **Grommets** (2-3') - Free
- **Rope** - Additional cost
 - 500 pound nylon cord welded with 2' of slack
 - Location: top, bottom, top & bottom
- **Pole Pockets** - Additional cost
 - Size: 1, 2, 3, or 4" (Dimensions unchanged)
 - Location: top, bottom, top & bottom, left, right, left & right

Many other substrates available.
Ask your sales person for more details.

Call Customer Service

SOILS, CONDITIONERS & GROUND COVER



CHECK OUT OUR CLEARANCE ITEMS!

DROP SHIP VENDORS

Sungro

All goods must be ordered in full pallets of a single sku
Full truckloads = 24 pallets; half truckloads = 12 pallets
Less than truckload orders will be accepted IF matched and within a 75 mile range
There will be a \$125 drop off charge per stop for less than truckload orders
Black Gold, Proven Winners Soils, Sunshine and Fafard (where available) products can be combined on the same truckload
Customer Pick up orders must be picked up within 2 weeks notice of availability

Espoma (Soil)

9 pallet minimum order, must be ordered in full pallet quantities
Full truckload = 18 pallets
\$75 stop-charge for LTL shipments
\$250 flatbed request charge

Premier

1 pallet minimum order
Truckload = 22 pallets +/- 2 pallets depending on weight.
Generally 24 pallets
Prepaid on full truckloads
Freight surcharge may be applicable
Product availability can take up to 10 days for productions and up to 7 days for transportaion

Fertilome

Full truckload order is 22 +/- pallets
Partial load order is 12 pallets min and require a match, this might cause delays
\$450 Drop Charge
Can be combined with Lambert

Fox Farm

Full truckload = 18 pallets
FOB Pendleton SC

Michigan Peat

Full truckload = 18 pallets
Half Truckload = 9 pallets
Prepaid freight on full truckloads and \$200 stop charge on half load
3% pick up allowance
Please Refer to Zone Map for pricing

Lambert

Full truckload order is 22 +/- pallets
Partial load order is 12 pallets min and require a match, this might cause delays
\$450 Drop Charge
Can be combined with Ferti lome

Old Castle

Half Truck Load
Full Truck Load
\$150 Drop Charge Zoned Ship Locations
Each Drop Ship must come from one location
Standard increase or decrease rules apply
Please Refer to Zone Map for pricing and Locations

Coast of Maine

Half truck load - 9-10 pallets
Full truck load - 18+ pallets
Half loads incur a \$75 drop charge and require a suitable match
LTL is available for up to 6 pallets in van trailers
LTL surcharge is \$75 a pallet
Deliveries that require the use of a lift gate will be assessed a \$75 fee per load
Customers may scheduled pickups with their own mode of transportation
Customer is responsible for unloading with forklift (rated for 3,500 lbs) or accessible loading dock and pallet jack. No hand unloading. If not, they will be charges \$100 per drop



Griffin Greenhouse Retail WAREHOUSE Shipping Map

We are now shipping nationwide!

NATIONAL



2024

Refer to location key:

National items are stocked nationally
 Select items are sold East or West only; no exceptions

8" Kaleidoscope Planter

Premium plastic modular planter can be displayed individually each planter has a removable saucer ideal for succulents or shallow rooted planted.

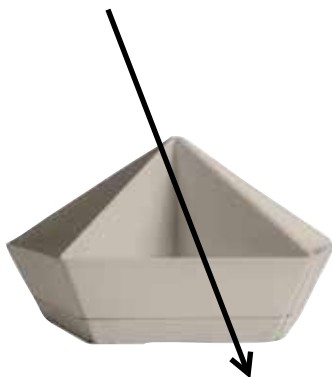

Item #	Desc	UPC	Vendor	CS/UOS	Location
80282643	Vanilla Bisque	770932844170	KDP08000A58	6/6	National

Where is the pricing?

1. Scan QR code on Chapter Pages to see pricing on Griffins.com
2. Contact your Griffin Sales Representative
3. Call into Griffin Customer Service 800.888.0054





Better Grow® Orchid Moss

High quality, five-star rated, natural imported sphagnum moss. Maintains adequate moisture, inhibits bacterial growth, and reduces shock when re-potting seedlings. Attractive to use in a wide variety of containers and cedar baskets. May also be used as a mounting medium for ferns.

Item #	Desc	UPC	Vendor	CS/UOS	Location
81830008	Brick	079925050452	50450	12/12	East

Better Grow® Orchid Bark

Specially sized grower's grade choice western fir bark. Quality potting mixture for all epiphytic orchids as well as a variety of ornamentals, such as bromeliads. Ideal for potting, re-potting, spot refilling, or as the base for a custom mixture. Comes in a handy re-sealable bag.

Item #	Desc	UPC	Vendor	CS/UOS	Location
81830004	4 qt.	079925050186	50180	15/15	East

Better Grow® Special Orchid Mix

A rich mixture of western fir bark, hardwood charcoal, and sponge rock to ensure healthy and long-lasting plants. Multi-purpose mixture that is appropriate for all epiphytic orchids. Provides your orchids with the drainage, air flow, and root ventilation they find and thrive on in nature. Comes in handy re-sealable bag.

Item #	Desc	UPC	Vendor	CS/UOS	Location
81830001	4 qt.	079925050001	50000	15/15	East



Hydrated Lime

Quickly raises soil pH, neutralizes soil acidity and provides Calcium. Improves soil structure.

Item #	Desc	UPC	Vendor	CS/UOS	Location
80100044	5lb.	037321009788	978	9/9	National

Aluminum Sulfate

Helps lower soil pH for acid loving plants such as azaleas, camellias, gardenias, hemlock, hydrangeas, holly and more. Includes easy-to-follow chart. Works in all soil types.

Item #	Desc	UPC	Vendor	CS/UOS	Location
80100134	4lb.	037321007050	705	12/12	National

Coast of Maine

Premium Leaf Compost

A natural material composed of recycled composted leaves and grass clippings. The end product is a dark, partially decomposed humus, similar to the natural organic matter found on the forest floor. Use to restore organic material to the soil when planting trees and shrubs, establishing a lawn, and in garden and flower bed preparation.



Item #	Desc	UPC	Vendor	CS/UOS	Location
81600064	40 lb.	783293003049	LC3001	75/5	East

Premium Mushroom Compost

This compost is sourced in the mushroom capital of the world, Avondale, PA and made from recycled mushroom growing media, providing a great source of organic matter. The result is a dark, rich compost that is ideal for all of your garden or lawn needs.



Item #	Desc	UPC	Vendor	CS/UOS	Location
81600065	40 lb.	783293003056	MC3001	75/5	East

Enriching Mulch with Kelp Fundy

Coast of Maine Fundy Blend Enriching Mulch with Kelp is the ideal top-dressing for roses and perennials. We combine some of our limited supply of very old, humified birch and maple bark with partially humified hemlock bark and a very rich blend of kelp solids and sphagnum moss peat. The result is an almost black humus that is rich in organic matter with all the added benefits of both compost and kelp.



Item #	Desc	UPC	Vendor	CS/UOS	Location
81600023	1 cf	609853000184	FU1000	80/8	East
81600022	2 cf	609853000498	FU2000	40/4	East

Coast of Maine



Cobscook Blend™ Organic & Natural Garden Soil

A compost-based premium soil for in-ground gardening. Made with a blend of salmon and blueberry compost mixed with aged bark, sphagnum peat moss, and horticultural limestone. It conditions the soil, retains moisture and also works well with acid-loving plants like azaleas, rhododendrons, holly, pieris and blueberry bushes.

Item #	Desc	UPC	Vendor	CS/UOS	Location
81600004	1 cf.	609853000047	CO1000	80/8	East
81600003	2 cf.	609853000276	CO2000	48/4	East

Lobster Compost Quoddy

Coast of Maine Quoddy Blend Lobster Compost is our best-selling soil, made with chitin and calcium-rich lobster shells, compost and peat humus. The result is a dark-brown, complex soil that drains well and is ideal for conditioning beds and borders, vegetable gardens, herbs and annuals!

Item #	Desc	UPC	Vendor	CS/UOS	Location
81600001	1 cf.	609853000221	QD1000	80/8	East

Castine Blend™ Organic & Natural Raised Bed Mix

An enriched blend of fully cured, locally-sourced compost, peat, biochar, worm castings, dehydrated poultry manure, kelp meal, lobster meal, greensand, lime, and mycorrhizae. Great for growing healthy vegetables, herbs, and flowers. OMRI Listed.

Item #	Desc	UPC	Vendor	CS/UOS	Location
81600084	1 cf.	609853000993	CA1000	80/8	East
81600061	2cf.	609853000931	CA2000	48/4	East

Penobscot Blend™ Organic & Natural Planting Mix

The product that launched our company! Our all-in-one planting mix for annuals, perennials, shrubs and trees or conditioning gardens, beds and borders. A rich blend of compost, tiny oyster shell fragments, and sphagnum peat moss. Shell fragments help aerate and add texture to your soil, which helps improve root growth.

Item #	Desc	UPC	Vendor	CS/UOS	Location
81600002	1 cf.	609853000030	PE1000	80/10	East

Bar Harbor Blend™ Premium Potting Soil

Our great all-purpose potting soil is made with natural and organic ingredients such as lobster, kelp, compost, perlite, and sphagnum peat. It is designed for potting indoor and outdoor container plants. Water and fertilize less with this nutrient rich, compost based potting soil. OMRI Listed.

Item #	Desc	UPC	Vendor	CS/UOS	Location
81600011	8 qt.	609853000948	BH4501	6/6	East
81600008	1cf.	609853000481	BH1000	80/8	East
81600007	2cf.	609853000467	BH2000	48/4	East

Stonington Aeration

A blend of coir and perlite has been a must have for hydroponic growers for years. At Coast of Maine we have developed our own unique blend by adding lobster meal and kelp meal bringing life and energy to this popular growing media.

Item #	Desc	UPC	Vendor	CS/UOS	Location
81600198	1.5 cf.	609853002058	SA1500	60/6	East

Stonington Blend™ Organic & Natural Grower's Mix

Grow Clean! Stonington Blend was created specifically for growing Cannabis. Rich in nutrients and formulated with amendments esigned to boost budding, blooming and root development, this complex "super soil" will take your plants growing in the vegetative stage to the next level! Designed for high performance growing in containers and large pots, this blend incorporates mycorrhizal ungi, kelp, fish bone and alfalfa meals, worm castings, peat, coir, and lobster compost. For best results, grow in 15 gallon containers. OMRI Listed.

Item #	Desc	UPC	Vendor	CS/UOS	Location
81600012	1.5 cf.	609853000689	ST1500	60/6	East

Wiscasset Blend™ Earthworm Castings

Gardeners have long known that there's magic in worm castings. Use to enrich potting soil with active biology and plant ready minerals or top-dress your indoor container plants to give them a boost. Castings can also be brewed into a quick compost tea by mixing with water, molasses and aerating overnight.

Item #	Desc	UPC	Vendor	CS/UOS	Location
81600014	8 qt.	609853000603	WI4501	6/6	East



Coast of Maine

Enriching Mulch Dark Harbor

Dark Harbor Blend Enriching Mulch is an exceptionally rich, naturally dark, fine textured blend of composted bark. It helps retain moisture and insulate the surface soil against temperature variations that can harm roots. Because it is composted, it will not rob the soil of nitrogen and can be dug into the beds in the fall to improve the organic content of the soil.



Item #	Desc	UPC	Vendor	CS/UOS	Location
81600021	1 cf	609853000177	DH1000	80/8	East
81600020	2 cf	025849110109	DH2000	40/4	East

Monhegan Blend™ Organic & Natural Black Earth Lawn Soil



An exceptional organic compost-based top soil, designed for top-dressing and repairing lawns, as well as general purpose use around the garden. Made with a blend of composts and sphagnum peat moss, it will retain moisture in order to facilitate grass seed germination. OMRI Listed.



Item #	Desc	UPC	Vendor	CS/UOS	Location
81600006	1 cf.	609853000245	MO1000	80/8	East

Schoodic Blend™ Organic & Natural Composted Manure Blend



For those who prefer traditional manure composts. This is an all-purpose soil conditioner designed for gardens, beds and borders. Made with a blend of composted cow manure from several local beef and dairy farms, and sphagnum peat moss. OMRI Listed.



Item #	Desc	UPC	Vendor	CS/UOS	Location
81600005	1 cf.	609853000252	SC1000	80/8	East

Mount Desert Island Blend™ Organic Cactus & Succulent Mix

Designed for cactus, succulents, tropical palms, and citrus plants. This pH balanced formula is made from: sphagnum peat moss, compost, sand, aged bark, biochar, fish bone meal, and kelp meal. It is ready-to-use and offers both excellent drainage and sufficient water retention. It is the perfect blend to promote root and plant growth.



Item #	Desc	UPC	Vendor	CS/UOS	Location
81600086	8 qt.	609853001006	MD4501	240/4	East

Organic & Natural Planting Soil for Roses & Flowers

The ideal planting mix to improve and revitalize the soil in and around all of your rose varieties, flowering annuals, and perennials. Perfect for supporting continual blooms and healthy foliage. Made with premium ingredients, it contains compost, sphagnum peat moss, aged bark, and lime.



Item #	Desc	UPC	Vendor	CS/UOS	Location
81600117	20 qt.	609853002027	RF3500	100/10	East

Organic & Natural Planting Soil for Tomatoes & Vegetables

The optimal soil conditioner to revitalize the soil in and around your vegetable garden beds. It is naturally lightweight and contains just the right ingredients to grow plentiful, flavorful tomatoes and vegetables. Made with premium ingredients, it contains compost, lobster, sphagnum peat moss, and lime.



Item #	Desc	UPC	Vendor	CS/UOS	Location
81600119	20 qt.	609853002003	TV3500	100/10	East

Organic & Natural Planting Soil for Acid Loving Plants

The ideal planting mix to improve and revitalize the soil in and around plants that thrive in lower pH soils like rhododendrons, azaleas, hollies, blueberries, strawberries, ferns, fuchsias, camellias, dogwoods, and conifers. Made with premium ingredients, it contains compost, sphagnum peat moss, and aged bark.



Item #	Desc	UPC	Vendor	CS/UOS	Location
81600118	20 qt.	609853002010	AL3500	100/10	East

Indoor Houseplant Mix

Specially formulated for indoor houseplants and flowers using coarse coconut coir, perlite, sphagnum peat moss, and aged bark to optimize drainage and aeration for robust root development. Whether you are growing peace lilies, spider plants, philodendrons, monstera, or other popular or exotic houseplants, this unique compost-free blend provides the optimum structure and benefits for nurturing strong, beautiful indoor plants and flowers.



Item #	Desc	UPC	Vendor	CS/UOS	Location
81600208	8 qt.	609853002096	HP4501	6/6	East
81600209	16 qt.	609853002102	HP4502	4/4	East



Total Advantage® Rose & Flower Fertilizer

Dr. Earth® Total Advantage® Rose & Flower Fertilizer is formulated to feed flowering plants naturally to promote bigger and more abundant blooms. Dr. Earth® Total Advantage® Rose & Flower Fertilizer is great for all roses, flowers, flowering trees, shrubs as well as annuals & perennials.

Item #	Desc	UPC	Vendor	CS/UOS	Location
81160208	4lb	749688405102	702p	12/12	West

Exotic Blend® Cactus & Succulent Potting Mix

A perfect blend of soil that provides the best life for your succulents and cacti. This blend has excellent drainage and water holding capabilities simultaneously. Cactus, succulents and all drought tolerant plants will enjoy a home in our mix specially designed for their needs.

Item #	Desc	UPC	Vendor	CS/UOS	Location
81160226	8qt	749688008105	810	4/4	West
81160230	16qt	749688008440	844	1/1	West

Premium Gold® All Purpose Fertilizer

Premium Gold® All Purpose Fertilizer produces remarkable results. Nutrients are released immediately and over several months. Premium formula provides optimum nutrition. Plants don't lie – it's great for every plant in the garden!

Item #	Desc	UPC	Vendor	CS/UOS	Location
81160200	4lb	749688916875	706p	12/12	West

Spectacular® Bulb Food Fertilizer

'Spectacular® dry fertilizer is formulated for tubers, edibles, and ornamentals. Use on summer and winter crops – containerized or in-ground. For best results, use during initial planting and re-apply on a regular basis.

Item #	Desc	UPC	Vendor	CS/UOS	Location
81160204	4lb	749688828093	700p	12/12	West

Pot of Gold® All Purpose Potting Soil

Pot of Gold® All Purpose Potting Soil is recommended for use in all outdoor and indoor potting and container applications. Pot of Gold® is great for many projects in the garden. In addition to container planting, Pot of Gold® can be used as a soil amendment for in-ground planting: trees, shrubs, bare root planting, flowers and vegetables; mulching; and seed cover. Great for indoor garden production.

Item #	Desc	UPC	Vendor	CS/UOS	Location
81160301	8qt	749688008136	813	4/4	West
81160298	16qt	749688008457	845	1/1	West
81160294	1.5cf	749688625999	728	60/60	West

Home Grown® Tomato, Vegetable & Herb Fertilizer

Home Grown® fertilizer is formulated to feed vegetable gardens, summer and winter crops, container plantings or native backyard soil. Use it during initial planting of seeds, transplanting, and on a regular basis as a top dressing or compost tea.

Item #	Desc	UPC	Vendor	CS/UOS	Location
81160265	8qt	749688008266	826	4/4	West
81160262	16qt	749688008280	828	1/1	West
81160259	1.5cf	749688230759	806	60/60	West

Life® All Purpose Pelletized

Easy to use organic hand crafted, pelletized fertilizer, just throw and go. Great for ground cover, hanging baskets, and the rest of your garden. Provides balanced and quick nutrition for all vegetables, flowers, potted plants, and spot treating lawns.



Item #	Desc	UPC	Vendor	CS/UOS	Location
81160197	4lb	749688736015	736p	12/12	West

Root Zone® Starter Fertilizer

Root Zone® fertilizer is formulated to feed all transplants, vegetable garden plants, both summer and winter plants, in containers or in native soil found in your yard. It is best used when planting seeds or transplanting anything into a new container or at home in the garden.



Item #	Desc	UPC	Vendor	CS/UOS	Location
81160202	4lb	749688100106	701p	12/12	West
81160343	8qt	749688008235	823	4/4	West

Pelletized Soil Acidifier Plant Food Fertilizer

It is a great source of sulfur which promotes dark green growth and is ideal for all acid loving plants, lawns, evergreens, trees and vegetables. It is effective in helping to turn hydrangeas blue. The pelletized granule form makes it easy to handle and easier to break down in the soil.



Item #	Desc	UPC	Vendor	CS/UOS	Location
81160117	6lb	749688079921	7992	4/4	West

Pelletized Garden Lime Plant Food Fertilizer

Pelletized Garden Lime helps to raise the pH in soils to aid plants in maximizing nutrient intake. Great source of calcium and magnesium which are important nutrients for plant growth and health. Ideal for for vegetable and flower gardens and is effective in helping to turn hydrangeas pink. The pelletized form makes it easy to handle and easier to break down in the soil.



Item #	Desc	UPC	Vendor	CS/UOS	Location
81160118	6lb	749688079938	7993	4/4	West

Natural Wonder® Fruit Tree Fertilizer

Natural Wonder® fertilizer is formulated to feed all fruit trees, berries, and fruiting vines in containers or any backyard soils. It can be used during the initial transplanting after digging the hole or anytime of the year to feed actively growing fruit trees and vines.



Item #	Desc	UPC	Vendor	CS/UOS	Location
81160198	4lb	749688717922	708p	12/12	West

Vegetarian Potting Soil

Free Potting Soil is a potting soil that is free of any animal byproducts. Free can be used as a soil amendment for in-ground planting: trees, shrubs, bare root planting, flowers and vegetables; mulching; and seed cover. Great for indoor garden production. TruBiotic technology contributes to drought tolerance, enhanced nutrient availability and increased plant performance. It contains no synthetic ingredients, GMO infested chicken manure or sewage sludge and is sustainably made in the U.S.A.



Item #	Desc	UPC	Vendor	CS/UOS	Location
81160241	8qt	749688008525	852	4/4	West

Mother Land® All Purpose Planting Mix

Mother Land® All Purpose Planting Mix creates the perfect soil conditions to promote plant health and vigor in all outdoor planting applications. Mother Land® is great for many projects in the garden. It's the perfect mix for large outdoor containers, use as an amendment for planting trees, shrubs, bare root planting, flowers & vegetables.



Item #	Desc	UPC	Vendor	CS/UOS	Location
81160276	1.5cf	749688010917	729	60/60	West



DECORATIVE GLASS COLLECTION

The 1.5lb Glass items are Decorative Glass. Used most commonly as planter toppers, floral arrangements, terrariums and indoor glassware.



Ice Clear Glass



Turquoise Glass



Bahama Blend Glass

Ice Clear Glass

Item #	Desc	UPC	Vendor	CS/UOS	Location
82510002	1/4" - 1/2"	855420008040	EP-G-01	12/12	West

Turquoise Glass

Item #	Desc	UPC	Vendor	CS/UOS	Location
82510003	1/4" - 1/2"	855420008057	EP-G-04	12/12	West

Bahama Blend Glass

Item #	Desc	UPC	Vendor	CS/UOS	Location
82510004	1/4" - 1/2"	855420008088	EP-G-08	12/12	West



POLISHED COLLECTION



Black Gravel

Black Pebbles

Jade Gravel



Jade Pebbles

Mixed Gravel

Mixed Pebbles

Polished Black Gravel

Item #	Desc	UPC	Vendor	CS/UOS	Location
82510009	5.5lb	855420008132	PBS-0510J	6/6	West

Polished Black Pebbles

Item #	Desc	UPC	Vendor	CS/UOS	Location
82510010	5lb	855420008149	PBS-1030J	6/6	West

Polished Jade Gravel

Item #	Desc	UPC	Vendor	CS/UOS	Location
82510013	5lb	855420008170	PJS-0510J	6/6	West

Polished Jade Pebbles

Item #	Desc	UPC	Vendor	CS/UOS	Location
82510014	5lb	855420008187	PJS-1030J	6/6	West

Polished Mixed Gravel

Item #	Desc	UPC	Vendor	CS/UOS	Location
82510011	5lb	855420008156	PMS-0510J	6/6	West

Polished Mixed Pebbles

Item #	Desc	UPC	Vendor	CS/UOS	Location
82510012	5lb	855420008163	PMS-1030J	6/6	West

NATURAL COLLECTION

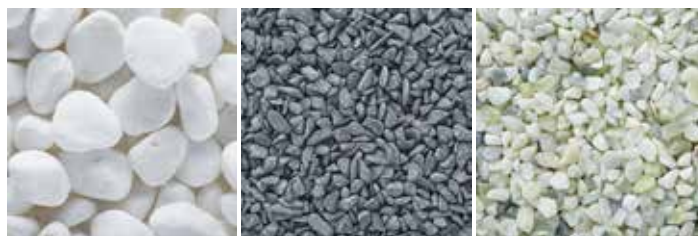

Snow White Pebbles

Black Bean Pebbles

Jade Bean Pebbles



White Bean Pebbles

Wood Bean Pebbles

Black Bean Pebbles

Item #	Desc	UPC	Vendor	CS/UOS	Location
82510015	5lb	855420008194	PSW-0510J	6/6	West

Black Bean Pebbles

Item #	Desc	UPC	Vendor	CS/UOS	Location
82510005	5lb	855420008095	BPBS-460J	6/6	West

Jade Bean Pebbles

Item #	Desc	UPC	Vendor	CS/UOS	Location
82510007	5lb	855420008118	BPJS-464J	6/6	West

White Bean Pebbles

Item #	Desc	UPC	Vendor	CS/UOS	Location
82510006	5lb	855420008101	BPWS-461J	6/6	West

Wood Bean Pebbles

Item #	Desc	UPC	Vendor	CS/UOS	Location
82510008	5lb	855420008125	BPWS-468J	6/6	West

White Decor Sand

Exotic Pebbles decor Sand is perfect for use in terrarium, air gardens, floral decorations, and much more. 1.5 Lb. Jar



Item #	Desc	UPC	Vendor	CS/UOS	Location
82510001	1.5lb Jar white	855335007466	EP-R-40-10C	12/12	West



Organic Cactus Mix

A rich, premium blend of sphagnum peat moss, peat humus, sand and perlite that has been enriched with Myco-tone®. Provides optimum aeration and drainage for cactus, palm and citrus plants. Improves moisture retention. Reduces drought stress and promotes root growth.

Item #	Desc	UPC	Vendor	CS/UOS	Location
80030209	4 qt.	050197703048	CA4	12/12	National
80030208	8 qt.	050197703086	CA8	6/6	National

Bonsai Mix

Elevate your bonsai gardening experience with Espoma Organic Bonsai Mix. This premium organic blend is specially formulated to provide the ideal growing conditions for your prized bonsai trees.

Item #	Desc	UPC	Vendor	CS/UOS	Location
80030213	4 qt.	050197718042	BO4	12/12	National

Earthworm Castings

Use both indoors and outdoors. For roses, flowers, vegetables, trees, shrubs & houseplants.

Item #	Desc	UPC	Vendor	CS/UOS	Location
80030140	4 qt.	050197718042	EC4	12/12	National

Organic Perlite

All natural, 100% pure product. Loosens soils and prevents compaction. Aerates soil and promotes root growth. Great for improving heavy soils and can be used for cuttings

Item #	Desc	UPC	Vendor	CS/UOS	Location
80030039	8 qt.	050197707084	PR8	6/6	National

Organic Moisture Mix

All moisture potting mix with coir Myco-tone for bigger blooms better drought resistance. Enhanced with coir absorbs more water. Protects against over and under watering. Premium blend, natural and organic.

Item #	Desc	UPC	Vendor	CS/UOS	Location
80030143	8 qt.	050197712088	MM8	6/6	National
80030142	1cf.	050197712019	MM1	75/1	National

Organic African Violet Mix

A rich, premium blend of sphagnum peat moss, peat humus and perlite. Improves aeration and moisture retention. For African violets and other house plants. Promotes root growth.

Item #	Desc	UPC	Vendor	CS/UOS	Location
80030027	4 qt.	050197702041	AV4	12/12	National

Organic Orchid Mix

Improves drainage & aeration for orchids epiphytes bromeliads.

Item #	Desc	UPC	Vendor	CS/UOS	Location
80030096	4 qt.	050197704045	OR4	12/12	National

Organic Horticultural Charcoal

Espoma Organic Charcoal is an all-natural high carbon material that can help improve soils. It is produced by heating untreated hardwoods to very high temperatures without oxygen in a process called pyrolysis. The result is an excellent soil conditioner for improving potting mixes and adding better drainage in containers.



Item #	Desc	UPC	Vendor	CS/UOS	Location
80030216	4 qt.	050197719049	HC4	12/12	National

Peat Moss

All natural sphagnum peat moss. Improves aeration & moisture retention. Great for improving heavy soils.



Item #	Desc	UPC	Vendor	CS/UOS	Location
80030098	8 qt.	050197706087	PTM8	6/6	National

2024



Organic Potting Mix

A rich, premium blend of sphagnum peat moss, peat humus and perlite that has been enriched with Myco-tone® and fortified with worm castings. For all indoor and outdoor containers.

Item #	Desc	UPC	Vendor	CS/UOS	Location
80030029	4 qt.	050197701044	AP4	12/12	National
80030040	8 qt.	050197701082	AP8	6/6	National
80030001	16 qt.	050197701167	AP16	120/5	National
80030002	1 cu. ft.	050197701013	AP1	75/5	East
80030013	2 cu. ft.	050197701020	AP2	48/6	East

Organic Raised Bed Mix

Organic Raised Bed Mix is fortified with worm castings, alfalfa, kelp and feather meal. Help builds strong roots. Use for in-ground plantings. Enhanced with Myco-tone. Used for raised bed planting. This product is formulated from 55% to 65% aged forest products, Canadian sphagnum peat moss, perlite, limestone to adjust pH, alfalfa meal, kelp meal, feather meal, earthworm castings and yucca extract.

Item #	Desc	UPC	Vendor	CS/UOS	Location
80030198	1.5 cu. ft.	050197714013	RB15	60/10	East

Organic Land & Sea Compost

Espoma Organic Land & Sea Gourmet Compost is the ultimate compost mix to use for planting vegetables, flowers, trees and shrubs. It contains a rich blend of the finest natural ingredients and is enhanced with crab & lobster shells from the sea along with Myco-tone, our proprietary blend of mycorrhizae, to help build strong roots and better plants.

Item #	Desc	UPC	Vendor	CS/UOS	Location
80030199	1 cu. ft.	050197715010	LSC1	75/5	East

Mushroom Compost

Espoma Organic Mushroom Compost Blend is the ultimate compost mix to use for planting vegetables, flowers, trees and shrubs. It combines rich mushroom compost with aged forest products to make the perfect soil conditioner. These fine ingredients come together to create a high quality finished compost.

Item #	Desc	UPC	Vendor	CS/UOS	Location
80030201	.75cf	050197717755	MC75	75/75	East

Organic Garden Soil

A rich, premium blend of the finest natural ingredients. It contains sphagnum peat moss, peat humus, and earthworm castings to help loosen heavy soil. Also enriched with Myco-tone®, our proprietary blend of 11 strains of endo and ecto mycorrhizae. Perfect for in-ground plantings and raised beds.



Item #	Desc	UPC	Vendor	CS/UOS	Location
80030128	All-Purpose 1 cu. ft.	050197711012	APGS1	75/5	East
80030129	Garden Soil 1 cu. ft.	050197710015	VFGS1	75/5	East



Garden Gypsum

An all natural mineral that can help loosen clay soils, minimize salt damage to plants, and help promote root growth. Pelletized for easy application. Helps cure turf burns from ice-melters and pets.

Item #	Desc	UPC	Vendor	CS/UOS	Location
80030079	6lb.	050197022064	GG6	6/6	National
80030078	36lb.	050197022361	GG36	1/1	National

Organic Soil Acidifier

The finest, most effective soil acidifier available. It contains all natural minerals that can be used to correct the problem of alkaline soil. Lowers the pH of soils for optimum growth of acid-loving plants. Provides fast acting and long lasting source of sulfur. Turns hydrangeas blue.

Item #	Desc	UPC	Vendor	CS/UOS	Location
80030030	6 lb.	050197030069	GSUL6	6/6	National

Organic Garden Lime

The finest grade of pelletized, dolomite limestone available. It can be used anywhere in the garden and landscape where a higher (less acidic) soil pH is desired. It adjusts soil pH so plants are able to make the most of the fertilizer you apply.

Item #	Desc	UPC	Vendor	CS/UOS	Location
80030223	5lb.	050197020053	GL5	12/12	National



African Violet Mix

Formulated with a peat blend that provides good air capacity and water retention. It is an excellent mix for African Violets but it's also indicated for all the plants of the Gesneriad family such as Streptocarpus, Episcias and Gloxinias.

Item #	Desc	UPC	Vendor	CS/UOS	Location
82280375	4 qt.	066498099476	9947	12/12	East

Succulent Mix

The perfect ready to use potting mix for all your favorite succulents. The Blend of sphagnum peat, EcoPeat*, and perlite will ensure maximum porosity, superior drainage and ideal water retention.

Item #	Desc	UPC	Vendor	CS/UOS	Location
82280386	4 qt.	066498099346	9934	12/12	East
82280385	8 qt.	066498099353	9935	6/6	East

Cactus Mix

This coarse mix, with granite sand and extra perlite, duplicates conditions found in arid environments. This heavyweight potting mix performs well under low water application. For use on Cactus and Succulents

Item #	Desc	UPC	Vendor	CS/UOS	Location
82280377	4 qt.	066498099377	9937	12/12	East
82280376	16 qt.	066498099391	9939	70/10	East

Perlite Mix

These lightweight particles increase aeration and decrease water holding when incorporated into soil. Add to potting mixes for extra drainage for water-sensitive succulents and cacti.

Item #	Desc	UPC	Vendor	CS/UOS	Location
82280381	8 qt.	066498099551	9955	6/6	East

Horticultural Charcoal

A filter to absorb impurities in water and improve air quality. It is excellent as a layer in the bottom of containers and in terrariums where water may pool. Charcoal also can help absorb impurities in fertilizer.

Item #	Desc	UPC	Vendor	CS/UOS	Location
82280378	4 qt.	066498099773	9977	12/12	East

Organic Canadian Sphagnum Peat Moss

Ready to use, pre-moist loose filled peat moss. It is offered in an easy to carry 8 quart size for the convenience of the consumer. As the larger bale sphagnum peat moss this product is pre-screen and stick free.



Item #	Desc	UPC	Vendor	CS/UOS	Location
82280358	8 qt.	066498099858	9985	6/6	East

Decorative Sphagnum Moss

Provides a long cut, fibrous material. Great for decorative floral arrangements. Superior water holding capacity.

Item #	Desc	UPC	Vendor	CS/UOS	Location
82280379	8 qt.	066498098158	9815	6/6	East

Vermiculite Mix

The mineral Mica, super-heated to expand much like an accordion. This mineral is other used in soil mixes to increase water holding capacity. Many growers use vermiculite in their flats in order to create a micro environment that will protect seeds from air currents and insulate the seeds to provide uniform germination temperatures.



Orchid Mix

a blend of sphagnum peat chunks, red bark, hardwood charcoal, and volcanic lava rock combined to create an environment that will prevent the roots from being kept too wet while providing humidity. Excellent drainage and secure anchoring for the roots makes this long-lasting mix ideal for your orchids.

Item #	Desc	UPC	Vendor	CS/UOS	Location
82280380	4 qt.	066498098271	9827	12/12	East

Item #	Desc	UPC	Vendor	CS/UOS	Location
82280387	8 qt.	066498099650	9965	6/6	East



Organic Seed & Cutting Mix

Ideal starter for germinating seeds and rooting leaf, stem, and root cuttings. The sphagnum peat blend with a wetting agent provides an excellent balance between moisture retention and air capacity to prevent root disease while promoting efficient rooting.



Item #	Desc	UPC	Vendor	CS/UOS	Location
82280384	4 qt.	066498097984	9798	12/12	East

Organic Potting Mix

This rich potting mix includes Mycorrhizae, worm castings, and humic acids. A slow release organic fertilizer and added moisture control helps keeps plants healthy over time. Many uses indoors or outdoors, including seed germination, potted plants, hanging baskets, and container gardens.



Item #	Desc	UPC	Vendor	CS/UOS	Location
82280366	40 qt.	0664980097953	9795	75/10	East
82280367	8 qt.	066498097960	9796	6/6	East

Organic Raised Bed Mix

A formulated blend of Canadian sphagnum peat moss, EcoPeat*, shrimp flour, and seaweed extract that provides extended release of organic nutrition. Suitable for all types of organic raised bed gardening, it supports an excellent ratio of drainage and water retention.



Item #	Desc	UPC	Vendor	CS/UOS	Location
82280368	40 qt.	066498098059	9805	75/10	East

Compressed Peat

Sphagnum Peat Moss adds body to thin and sandy soils and aerates heavy and sandy soil. The soil amendment also reduced erosion and fertilizer leaching and protects soil from drying and hardening.



Item #	Desc	UPC	Vendor	CS/UOS	Location
82280355	3 cf	064277124081	03175	8/8	East



Ultimate Potting Mix

All purpose mix ideal for outdoor and indoor plants.

Item #	Desc	UPC	Vendor	CS/UOS	Location
82280364	8 qt.	066498099056	9905	6/6	East
82280363	25 qt.	0664980099018	9901	91/10	East
82280362	50 qt.	0664980099025	9902	65/10	East

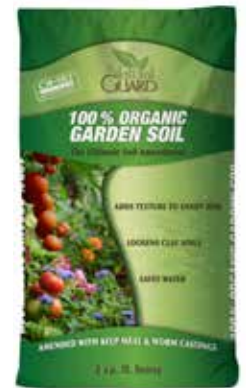

Organic Garden Soil

A blend of supercharged Black Peat with humic and fulvic acids, worm castings and kelp meal. The best garden conditioner substitute for sphagnum peat moss for square foot gardens. Perfect for flowers, vegetables and herbs.

Item #	Desc	UPC	Vendor	CS/UOS	Location
82280370	2.0 cf	066498097922	9792	65/10	East



Cocoa Shell Mulch

An organic mulching material made from the outer shell of the cocoa bean. Shells breaks down slowly and will not disappear into the soil. Helps reduce weeds, conserves water, insulates in the winter and adds nutrition to the soil, it will not burn vegetation. Natural color and pleasing cocoa aroma.



Item #	Desc	UPC	Vendor	CS/UOS	Location
82340001	2 cu ft	096852215874	CS2CF	60/60	East



Happy Frog Potting Soil Conditioner

In every bag of Happy Frog® Soil Conditioner you'll find finely-screened aged forest products, earthworm castings, and bat guano, not to mention soil microbes to help increase root efficiency and encourage nutrient uptake. We also add humic acids, which may increase the uptake of important micronutrients.



Item #	Desc	UPC	Vendor	CS/UOS	Location
82000174	1.5 cu ft	752289590047	0047	75/5	National

Happy Frog Potting Soil

Happy Frog® Potting Soil is designed for container planting. Whether you're growing a ficus in the dining room, a geranium on the patio, or a lemon tree on the deck, use our Potting Soil in your containers. For additional nutrition, blend in our Happy Frog® Fruit & Flower Fertilizer. Then sit back and enjoy the results.



Item #	Desc	UPC	Vendor	CS/UOS	Location
82000152	12qt	752289590016	590016	120/10	National
82000153	2 cf	752289590023	590023	60/6	East
82000224	2 cf	025849109813	HF2.0W	60/6	West



Ocean Forest Potting Soil

FoxFarm's most popular potting soil, Ocean Forest® is a powerhouse blend of aged forest products, sphagnum peat moss, earthworm castings, bat guano, fish meal, and crab meal.

Item #	Desc	UPC	Vendor	CS/UOS	Location
82000167	12 qt	752289790041	790041	120/10	National
82000168	1.5 cu ft	752289790058	790058	75/5	East
82000223	1.5 cu ft	025849107512	1020051RG	75/5	West
82000164	3.0 cu ft	752289690044	690044	36/6	National

Cultivation Nation Seventy Thirty

Cultivation Nation® Seventy Thirty Growing Media is a mixture of buffered coconut coir and perlite, blended in the classic ratio of 70:30. Coconut coir is known for its water holding capabilities, and perlite is included to provide air spaces in the media, facilitating aeration and drainage. Cultivation Nation® Seventy Thirty Growing Media is great for use with customized feeding schedules in indoor and outdoor containers.



Item #	Desc	UPC	Vendor	CS/UOS	Location
82000220	2.0 Cu Ft	752289690068	690068	1/1	National

Strawberry Fields Fruit & Flower Pot Soil

Strawberry Fields® Fruiting & Flowering Potting Soil is designed to pump up your blooms, fruits and berries with no hang-ups. Brought to you directly from the Flower Children of the Sixties and Seventies—the Old School generation. Love, Peace and Happiness is in our hearts and that is exactly what we pour into every bag of Strawberry Fields®. Out-A-Sight!



Item #	Desc	UPC	Vendor	CS/UOS	Location
82000158	1.5 cu ft	752289591044	591044	75/5	National

Salamander Soil Potting Mix

Seedlings and plants will have access to the nectars of a moisture mix full of life giving properties. Plants that are grown in hot climates need that extra thirst quench so that they can stay vigorous and not get stressed from drying out. We have created water holding salamander soil so that your plants can moisturize in the same way as this special animal.



Item #	Desc	UPC	Vendor	CS/UOS	Location
82000160	1.5 cf	752289591105	591105	75/5	National

Planting Mix

Original Planting Mix is a blend of soil amendments such as aged forest products, sphagnum peat moss and earthworm castings. Use our Original Planting Mix for all your gardening projects. The aged forest products and peat moss in FoxFarm Original Planting Mix may make it more effective at holding moisture around the roots of plants.



Item #	Desc	UPC	Vendor	CS/UOS	Location
82000166	1.0 cu ft	752289790010	790010	75/5	National



Coco Loco Potting Mix

Plants growing in Coco Loco® will not require water as often as your usual potting mix. Whether you're growing in hanging baskets, vertical gardens, containers, or seedling trays, extend your watering schedule. In most climates, every two to three days will be enough. Always adjust your watering schedule as needed.



Item #	Desc	UPC	Vendor	CS/UOS	Location
82000156	2 cf	752289591020	591020	48/6	National

Light Warrior Potting Soil

Light Warrior® Seed Starter is designed to promote an environment beneficial to seed germination and root development. Light Warrior Seed Starter includes soil microbes that can help enhance root efficiency and encourage nutrient uptake. We've also included earthworm castings, a gentle source of nutrition for seedlings and small plants. Use Light Warrior Seed Starter for seed germination, cuttings and new plant starts for both indoor and outdoor cultivation.



Item #	Desc	UPC	Vendor	CS/UOS	Location
82000169	1.0 cu ft	752289790096	790096	75/5	National

Ko Ko Bop Coconut Coir Blend

KO KO BOP® is a blend of renewable coconut coir and aged forest products with perlite for aeration. This grow bag is ready for planting. Plant directly into this bag for all growing applications.



Item #	Desc	UPC	Vendor	CS/UOS	Location
82000165	3.0 cu ft	752289690051	690051	36/6	National



Garden Gypsum

Loosens clay soils, allowing air and water to penetrate.; Improves drainage and helps fertilizer work better. Natural materials won't upset soil pH.



Item #	Desc	UPC	Vendor	CS/UOS	Location
80070036	5 lb.	071605170054	17005	9/9	East

Cactus & Succulent Soil Mix

Professionally formulated for use with both jungle and desert cacti. Provides the drainage cacti need to flourish. Ready-to-use; pH balanced. Encourages bloom and root development. Complete package directions provide useful growing information.



Item #	Desc	UPC	Vendor	CS/UOS	Location
80070004	4 qt.	071605104042	10404	12/12	East
80070005	10 qt.	071605104103	10410	5/5	East

Organic African Violet Soil Mix

Provides the optimum growing medium for all types of African violets. Light and loose, encourages healthy foliage and beautiful blooms.



Item #	Desc	UPC	Vendor	CS/UOS	Location
80070001	4 qt.	071605103014	10301	12/12	East

Organic Special Orchid Mix

Provides optimum growth for epiphytic orchids. Provides proper drainage orchids require for development and growth. Premixed, ready to use. Ideal for repotting.



Item #	Desc	UPC	Vendor	CS/UOS	Location
80070006	4 qt.	071605108040	10804	12/12	East
80070007	8 qt.	071605108088	10808	6/6	East



Alabaster Blend Stone Chips

Clean, white, marble chips. Not dusty.



Item #	Desc	UPC	Vendor	CS/UOS	Location
80070090	2 qt.	071605141023	14102	6/6	East

Western Desert Sand

Clean, washed silica sand. Excellent for formulating your own cactus soil. Mix with Garden Soil to create a loamy soil.



Item #	Desc	UPC	Vendor	CS/UOS	Location
80070086	2 qt.	071605143027	14302	6/6	East

Volcanic Lava Rock

A great decorative moisture retainer for potted or bedded plants.



Item #	Desc	UPC	Vendor	CS/UOS	Location
80070088	Red 2 qt.	071605144024	14452	10/10	East
80070157	Black 2 qt.	079925050001	50000	10/10	East

Organic Canadian Sphagnum Peat Moss

Premium grade of coarse Canadian sphagnum peat moss. When mixed with soil, increases the soil's capacity to hold water and nutrients. Can be blended with perlite and vermiculite when custom soilless potting mix is desired.

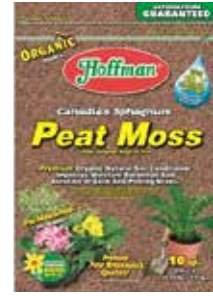

Item #	Desc	UPC	Vendor	CS/UOS	Location
80070044	10 qt.	071605155037	15503	6/6	East
80070045	18 qt.	071605155068	15506	4/4	East

Marble Maze River Gravel

Pea sized Chesapeake yellow river gravel. Multiple uses indoor & outdoor.

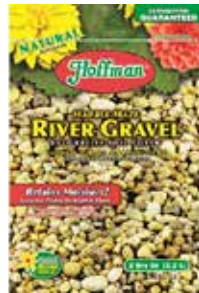

Item #	Desc	UPC	Vendor	CS/UOS	Location
80070089	2 qt.	071605142020	14202	6/6	East

Pelletized Horticultural Lime

The dust free way to reduce soil acidity in lawns and flower and vegetable gardens. Easy to spread by hand or spreader. Stays where applied. Does not blow away.



Item #	Desc	UPC	Vendor	CS/UOS	Location
80070039	4 lb.	071605152043	15204	12/12	East

Organic Cow Manure (1-1-1)

Adds all natural nutrients to soil to help produce healthy growth. Helps build humus content and improves overall soil texture. Non-burning, safe, easy-to-apply. Encourages earthworm activity.



Item #	Desc	UPC	Vendor	CS/UOS	Location
80070060	4 lb.	071605210040	21004	10/10	East
80070061	20 lb.	071605210200	21045	120/10	East

Organic Dehydrated Super Manure (4-2-3)

Dehydrated poultry manure in easy-to-apply pelletized form. Improves soil texture; builds humus content without burning. Produces outstanding results in flower and vegetable gardens, and lawns.



Item #	Desc	UPC	Vendor	CS/UOS	Location
80070063	5 lb.	071605205053	20505	9/9	East
80070064	20 lb.	071605205206	20545	120/10	East

2024



West Coast Fir Bark

An attractive miniature bark that is aromatic and clean.



Item #	Desc	UPC	Vendor	CS/UOS	Location
80070087	2 qt.	071605145021	14552	10/10	East

Horticultural Vermiculite

Soil conditioner that loosens soil, provides aeration and retains water. Can be used to start seeds, propagate cuttings and store bulbs. Blend with peat moss and perlite for custom soilless mix.



Item #	Desc	UPC	Vendor	CS/UOS	Location
80070050	8 qt.	071605160024	16002	6/6	East
80070051	18 qt.	071605160048	16004	4/4	East
80070052	2 cu. ft.	071605160178	16045	60/1	East

Horticultural Perlite

Lightweight soil conditioner that loosens clay soil, reduces caking and improves drainage and aeration. Can be used to start seeds, propagate cuttings and store bulbs. Blend with peat moss and vermiculite for custom soilless mix.



Item #	Desc	UPC	Vendor	CS/UOS	Location
80070047	8 qt.	071605165029	16502	6/6	East
80070048	18 qt.	071605165043	16504	4/4	East
80070049	2 cu. ft.	071605165173	16545	60/1	East

All Purpose Potting Mix Plus

Ideal for repotting plants, window boxes, outdoor containers and hanging baskets. Contains a wetting agent to maintain moisture levels.



Item #	Desc	UPC	Vendor	CS/UOS	Location
80070020	4 qt.	071605123043	12304	12/12	East
80070014	10 qt.	071605123104	12306	5/5	East
80070017	16 qt.	071605123166	12320	4/4	East

Blue Magic Aluminum Sulfate

Acidifying soil conditioner. Makes hydrangeas blue! Perfect for all acid loving plants.



Item #	Desc	UPC	Vendor	CS/UOS	Location
80070070	4 lb.	071605665055	66505	12/12	East

Bonsai Soil Mix

Provides optimum growth for evergreen and other bonsai plants. Provides the plant support, moisture and drainage bonsai need. Premixed, ready to use. Excellent for repotting.



Item #	Desc	UPC	Vendor	CS/UOS	Location
80070003	2 qt.	071605107081	10708	10/10	East

Charcoal Soil Conditioner

Use this Hoffman Charcoal Soil Conditioner to improve the soils texture, density, aeration and drainage. Charcoal can absorb excess moisture as well as remove odors. It is very effective in sweetening soils in terrariums and pots that lack appropriate drainage and need improved root oxygen levels. Comes in a quick zip resealable bag.



Item #	Desc	UPC	Vendor	CS/UOS	Location
80070035	24oz	071605175028	17502	12/12	East

Purely Organic Potting Soil

Ideal for repotting plants, window boxes, outdoor containers and hanging baskets. Contains a wetting agent to maintain moisture levels.



Item #	Desc	UPC	Vendor	CS/UOS	Location
80070008	4 qt.	071605125047	12504	12/12	East
80070009	8 qt.	071605125085	12508	6/6	East
80070011	16 qt.	071605125160	12520	4/4	East
80070013	1 cu. ft.	071605125016	12501	80/5	East



Top Soil

Recommended for conditioning flower beds and vegetable gardens. It is made of dark composted peat, a nutrient source that promotes plant growth.



Item #	Desc	UPC	Vendor	CS/UOS	Location
81940036	25 L	066498062005	6649806200	105/105	East

Complete Potting Mix w/ Moisture Crystals

Complete Potting Mix with Moisture Crystals is specially formulated to optimize the water retention of the mix and to maintain good aeration for good plant growth.



Item #	Desc	UPC	Vendor	CS/UOS	Location
81940038	1 cu ft	066498097588	6649809758	91/10	East
81940039	2 cu ft	066498097595	6649809759	65/10	East

Gardening Soil For Flowers & Vegetables



The organic material in this soil helps improve aeration of clay soils and increases water retention in sandy soils. The peat moss can reduce the loss of fertilizer through leaching in addition to helping to protect the soil against drying and curing.



Item #	Desc	UPC	Vendor	CS/UOS	Location
81940009	1.5 cu ft	066498064306	6649806430	75/10	East

Peat Moss

An excellent soil amendment because of its capacity to retain water, aerate the soil and it is completely natural. Lambert Peat Moss helps retain moisture, aerate soil, and provide organic matter for gardens and flower beds.



2024

Item #	Desc	UPC	Vendor	CS/UOS	Location
81940029	1.0 cu ft	066498051153	06649805115	100/10	East
81940030	2.2 cu ft	066498041154	06649804115	50/50	East
81940032	3.8 cu ft	066498021156	06649802115	30/1	East

Trees & Shrubs Planting Mix



The texture of this soil will promote its soil incorporation. With its pH adjusted, this mix will loosen the soil and peat contained therein will promote adequate ventilation to improve root growth.



Item #	Desc	UPC	Vendor	CS/UOS	Location
81940011	1.5 cu ft	066498064405	6649806440	75/10	East

Potting Mix



This Potting Mix is a general purpose media with numerous applications for indoor and outdoor use such as hanging baskets and containers. It is a favorite amongst plant lovers. The adjusted pH combined with perlite promotes aeration, drainage and assimilation of nutrients that are essential for optimum plant growth. This media is easy to use as it has been pre-moistened.



Item #	Desc	UPC	Vendor	CS/UOS	Location
81940008	1.5 cu ft	066498064504	6649806450	75/10	East



Professional Organic All Purpose Mix

This ready to use, environmentally friendly peat-based substrate promotes healthy and rapid plant growth for all your favorite flowers, vegetables, herbs, trees and shrubs.



Item #	Desc	UPC	Vendor	CS/UOS	Location
81940001	8 qt	066498064613	6649806460	6/6	East
81940040	16 qt	066498064634	6649806463	120/10	East
81940002	1.0 cu ft	066498064610	6649806461	90/10	East
81940003	2.0 cu ft	06649806462	6649806462	50/10	East



Cactus & Succulents Mix

Provides plants a media that reproduces similar conditions one would find in an arid environment. The sand allows good drainage and weight. The peat provides organic matter to the plants.



Item #	Desc	UPC	Vendor	CS/UOS	Location
81940021	4 qt	066498076132	6649807613	12/12	East

Sphagnum Moss

Used in the lining of wire frames and hanging baskets. It is used extensively by nurserymen for air layering. Some species of orchids, especially Phalaenopsis, are grown in large quantities using nothing but sphagnum moss.



Item #	Desc	UPC	Vendor	CS/UOS	Location
81940024	8 qt	066498075296	6649807529	6/6	East

Horticultural Vermiculite

An aggregate used to increase water retention in your potting mixes. It is very useful to cover germinating seeds. In fact, its water-holding properties and its considerable porosity aid in insulating the germinating seeds and protect them from drying out and from damaging air currents.



Item #	Desc	UPC	Vendor	CS/UOS	Location
81940026	8 qt	066498076255	6649807625	6/6	East

Orchids Mix

Blend of four components that provide many species of orchids an environment conducive for good root development. This mix also has more weight which aside from providing good anchorage of roots, also prevents the plants from easily being uprooted.



Item #	Desc	UPC	Vendor	CS/UOS	Location
81940022	4 qt	066498076170	6649807617	12/12	East

Horticultural Perlite

A good choice for plant lovers who wish to improve their potting mix drainage capacity. Perlite improves drainage in soils and is an excellent aggregate to root cuttings as it can be packed to hold a plant part in place until roots are initiated.



Item #	Desc	UPC	Vendor	CS/UOS	Location
81940025	8 qt	066498076217	6649807621	6/6	East

All Purpose Potting Mix

The ideal media for your indoor and outdoor growing needs. It is very suitable for use in various types and sizes of containers.



Item #	Desc	UPC	Vendor	CS/UOS	Location
81940012	4 qt	066498076002	6649807600	12/12	East
81940013	8 qt	066498076019	6649807601	6/6	East
81940041	16 qt	066498076064	6649807606	120/10	East
81940015	1.0 cu ft	066498076033	6649807603	91/1	East
81940016	2.0 cu ft	066498076040	6649807604	65/10	East

Horticultural Wood Charcoal

Filtration properties aid a media by purifying air and water. It is also used at the bottom of containers to aid in drainage of excessive water.



Item #	Desc	UPC	Vendor	CS/UOS	Location
81940023	4 qt	066498076194	6649807619	12/12	East



Pearl Stone Soil Covers™

Mosser Lee Pearl Stone represents the finest in quality rock bedding. The small particles are perfectly designed to loosen heavy soils and provide excellent bases for any gardening or craft project. Pearl Stone's rich grey color and small dimension are designed for creative creations.

Item #	Desc	UPC	Vendor	CS/UOS	Location
80130005	1.5qt	010367011229	1122	8/8	East

River Rock Soil Covers™

Mosser Lee River Rock is drawn from the cold flowing rivers of the deep Wisconsin woods. Millions of years of rushing water have naturally polished the once sharp lines of this natural rock into the beautiful River Rocks that we offer to you.

Item #	Desc	UPC	Vendor	CS/UOS	Location
80130007	1.5qt	010367011212	1121	8/8	East

White Marble Soil Covers™

Mosser Lee Marble Nuggets come from volcanically created substrate pushed to the surface by the changing earth's crust. Exposed marble, white from the mineral deposits, is mined and washed to create the perfect decorative stone.

Item #	Desc	UPC	Vendor	CS/UOS	Location
80130008	1.5qt	010367011304	1130	8/8	East

Soil Covers™

Mosser Lee's Natural Pebbles are an essential component for interior gardeners. Our pebbles are cleaned and carefully inspected to ensure product consistency. The raw natural-colored stones reflect the gentle washing action of flowing Wisconsin rivers.

Item #	Desc	UPC	Vendor	CS/UOS	Location
80130068	Natural Pebble	010367011236	1123	8/8	East

River Gravel Soil Covers™

Mosser Lee River Gravel is mined from river beds, dried by receding glaciers. Washed clean and tumbled by ancient rivers, these small stones moved down stream from the North.

Item #	Desc	UPC	Vendor	CS/UOS	Location
80130006	1.5qt	010367011205	1120	8/8	East

Forest Bark Soil Covers™

Mosser Lee® Forest Bark is harvested from fir trees after the logging process. Cleaned and uniformly sized, the Forest Bark retains its distinctive brown color for many years. The individual pieces are chosen knowing that they will be used to enhance the beauty of potted plants. Use as a soil cover for potted trees.

Item #	Desc	UPC	Vendor	CS/UOS	Location
80130003	1.5qt	010367011519	1151	8/8	East

Black Sand

Natural decorative product beautifies the appearance of baskets, planters, dish gardens, flower pots and artificial arrangements. Mined from ancient sand pits and river beds, these sand products are one of the highest quality sands on the market.

Item #	Desc	UPC	Vendor	CS/UOS	Location
80130001	1.5qt	010367011120	1112	8/8	East

Desert Sand

Mosser Lee Decorative Sands are selected especially for Mosser Lee for their luster. Mined from ancient sand pits and river beds, these sand products are the highest quality sands on the market.

Item #	Desc	UPC	Vendor	CS/UOS	Location
80130002	1.5qt	010367011106	1110	8/8	East

White Sand

Mosser Lee White Sand is used to retain moisture in plant soil, beautify indoor and outdoor container plants, improve plant drainage and create water and fountain designs. Ideal for terrariums, dish gardens and various craft and decorative uses.

Item #	Desc	UPC	Vendor	CS/UOS	Location
80130009	1.5qt	010367011113	1111	8/8	East



Polished Stone

Polished Stones make an attractive soil cover for indoor and outdoor container plants, including bonsai, cacti, and others. Beautify and enhance your plants by adding a decorative top layer of Polished Stones to your planters and pots. Polished Stones are also ideal for terrariums, aquariums, water and dish gardens, fountains, clear vases, and various craft and decorative projects. The number of uses for these stones is only limited by your imagination.



Item #	Desc	UPC	Vendor	CS/UOS	Location
80130017	White	010367011601	1160	8/8	East
80130015	Black	010367011618	1161	8/8	East

River Pebbles

There are many uses such as to retain moisture in plant soil, beautify indoor and outdoor containers, improve plant drainage, and create water and fountain designs. The small size is perfect for decoration and utility uses. These lightly polished stones can be used as a vase-filler for fresh or artificial arrangements. Perfect for terrariums and fairy gardens. They can be arranged in pots for.



Item #	Desc	UPC	Vendor	CS/UOS	Location
80130034	5lb.	010367021815	2181	8/8	East



Decorative Glass Gems

Mosser Lee's Glass Gems and Sea Glass are manufactured from high quality glass. The exceptional beauty and consistent size of the glass gems make them decorator essentials. The sea glass colors reflect the colors of the ocean with splashes of green, blue and clear. Hand packed in reusable plastic jars to insure high quality. Use for terrariums, dish gardens, vase filler and fairy gardens.

Item #	Desc	UPC	Vendor	CS/UOS	Location
80130026	Tuscan Gems	010367021419	ML2141	8/8	East
80130027	Elegant Blue Gems	010367021419	ML2121	8/8	East
80130028	Crystal Gems	010367021211	ML2131	8/8	East

Spanish Moss

Natural decorative product beautifies the appearance of baskets, planters, dish gardens, flower pots and artificial arrangements. Helps to retain moisture in containers and does not interfere with watering or fertilization.



Item #	Desc	UPC	Vendor	CS/UOS	Location
80130053	250 cu. in	010367005600	ML0560 8	8/8	East

Sheet Moss Soil Cover

Sheet moss is also ideal for arts and crafts. Our natural sheet moss is harvested on the floor of old growth forests. While we inspect and remove foreign material before packaging, it is a natural product and may contain traces of lichens, molds, and leaves that grow along with it.



Item #	Desc	UPC	Vendor	CS/UOS	Location
80130052	250 cu. in	010367005600	ML0560 8	8/8	East

Long Fibered Sphagnum Moss

Long fibered, fluffy and clean. Absorbs and retains up to twenty times its weight in water. Use for soilless gardening, transplanting, mulch and hanging basket filler. For soil mixes, it offers excellent root aeration. Also used for rooting bulbs and cuttings.



Item #	Desc	UPC	Vendor	CS/UOS	Location
80130014	432 cu. in.	010367001107	110	12/12	East

Fibered Sphagnum Moss

Absorbs and retains up to twenty times its weight in water, twice as much as a cellulose sponge. Invaluable for soilless gardening, transplanting, mulch and hanging basket filler. For soil mixes, it offers excellent root aeration. Also used for rooting bulbs and cuttings. Long fibered sphagnum moss is not peat moss, but rather a perennial plant that grows wild in the central Wisconsin sphagnum bogs.



Item #	Desc	UPC	Vendor	CS/UOS	Location
80130019	2 BU	010367001206	120	1/1	East

Our Premium Reindeer Moss comes in five stunning shades of green. Perfect for adding a burst of colour to any DIY project. Reindeer Moss has a fresh, soft, and spongy texture, bringing a natural feel to your creations.



Lime Premium Reindeer Moss

Item #	Desc	UPC	Vendor	CS/UOS	Location
82370077	Lime	660111997219	REIN-LM-0001	12/12	National

Shamrock Premium Reindeer Moss

Item #	Desc	UPC	Vendor	CS/UOS	Location
82370080	Shamrock	660111997240	REIN-SH-0001	12/12	National

Pistachio Premium Reindeer Moss

Item #	Desc	UPC	Vendor	CS/UOS	Location
82370078	Pistachio	660111997226	REIN-PI-0001	12/12	National

Kiwi Premium Reindeer Moss

Item #	Desc	UPC	Vendor	CS/UOS	Location
82370081	Kiwi	660111997257	REIN-KW-0001	12/12	National

Mint Premium Reindeer Moss

Item #	Desc	UPC	Vendor	CS/UOS	Location
82370079	Mint	660111997233	REIN-MT-0001	12/12	National

Preserved Moss

Preserved Moss is perfect for moss walls, moss decor, terrariums, lining baskets, moss art and much more. Preserved Moss is your choice if you want a more grassy & greener appearance above soil and around plant bases.



Item #	Desc	UPC	Vendor	CS/UOS	Location
82370038	50g	660111996892	PRES-G-0001	12/12	National

Natural Forest Moss

This Forest Moss can come back to life in the right conditions. Enough water, sun and love and you will have beautiful live moss! This Hypnum moss species takes about 6 months to fully grow.



Item #	Desc	UPC	Vendor	CS/UOS	Location
82370036	60g	660111996878	FOR-N-0001	12/12	National

Spanish Moss

This completely natural moss can come back to life in the right conditions. Enough water, sun and love and you will have beautiful live Spanish moss! This Spanish moss species takes about 6 months to fully grow but we do not guarantee growth. This moss is mainly used for decor purposes.



Item #	Desc	UPC	Vendor	CS/UOS	Location
82370037	70g	660111996885	SPAN-N-0001	12/12	National

Sphagnum Moss

Who doesn't love some good old Sphagnum Moss? This moss has been used most commonly for orchids. It can also be mixed in with your soil to act as a conditioner. This moss is also amazing for propagating your plants.



Item #	Desc	UPC	Vendor	CS/UOS	Location
82370035	50g	660111996861	SHAG-N-0001	12/12	National

PROMIX[®]

PRO-MIX All Purpose Mix

Ready-to-use, this peat-based mix is perfect for indoor and outdoor planting. Specially formulated for a wide range of plant species this mix offers ideal water holding, nutrient retention, and aeration properties. Plus the added benefit of MycoActive™ Organic Growth Enhancer, for guaranteed results!



Item #	Desc	UPC	Vendor	CS/UOS	Location
80310019	2 cu. ft. compressed	025849113308	1020030RG	50/5	East

PRO-MIX Premium Garden Mix

Perfect for planting in-ground outdoor plants as well as improving the quality of existing garden bed soil. It is specially formulated with a high percentage of peat humus and compost, making it the mix to use for plants that require more stability such as perennials and flowering shrubs. It also contains MycoActive™ Organic Growth Enhancer to produce vigorous growth and healthy plants. Loose fill.



Item #	Desc	UPC	Vendor	CS/UOS	Location
80310027	1 cu. ft.	025849111205	1010020RG	120/10	East
80310028	2 cu. ft.	025849107208	1020020RG	54/54	East

PRO-MIX Premium Potting Mix

Ready-to-use, this peat-based mix is perfect for all indoor and outdoor container planting. Specially blended for a wide range of plant species, this formulation provides optimum aeration, drainage and nutrients and features MycoActive™ Organic Growth Enhancer to produce vigorous growth and healthy plants. Feeds up to 9 months. Formulated with water-saving gel to hold extra water.



Item #	Desc	UPC	Vendor	CS/UOS	Location
80310015	8 qt.	025849109103	1008010RGCE	6/6	East
80310025	16 qt.	025849110109	1016010RGCE	210/6	East
80310017	1 cu. ft. loose fill	025849111106	1010010RG	120/10	East
80310018	2 cu. ft. loose fill	025849107109	1020010RG	54/54	East
80310053	2 cu. ft. compressed	025849003050	0305RG	35/35	East

PRO-MIX Premium Cactus Mix

Ready-to-use, this peat-based CACTUS MIX provides optimized air porosity and fast water draining qualities while maintaining adequate water retention for cacti and succulent needs. It also features MycoActive™ Organic Growth Enhancer to produce vigorous growth and healthy plants.



Item #	Desc	UPC	Vendor	CS/UOS	Location
80310035	8 qt.	025849109813	1008081RGCE	6/6	East

PRO-MIX Premium Organic Vegetable & Herb Mix

OMRI-Listed and Ready-to-use, this peat-based mix is perfect for all your vegetable, fruit, and herb garden needs, whether in-ground or in containers. It is specially formulated with an organic fertilizer that provides gradual feeding to your plants. The gypsum for amazing tomato growth, and MycoActive™ Organic Growth Enhancer helps produce greater yields and vigorous growth. Compressed bales expand to 4 cu. ft.



Item #	Desc	UPC	Vendor	CS/UOS	Location
80310013	1 cu. ft. loose fill	025849111519	1010051RG	120/10	East
80310014	2 cu. ft. loose fill	025849107512	1020051RG	54/5	East
80310054	2 cu. ft. compressed	025849002053	0205RG	35/5	East

Sphagnum Peat Moss

Sphagnum peat moss is well suited for both indoor and outdoor applications. It conditions all soils by improving aeration and it is used as a soil amendment for gardens as well as preparation and restoration of lawns. Compressed bale.



Item #	Desc	UPC	Vendor	CS/UOS	Location
80310007	1CF Compressed	025849002626	0262P	100/10	East
80310001	2CF Compressed	025849001285	0128P	50/50	East
80310010	3.8 cu. ft.	025849000820	0082P	30/1	East

Canadian Sphagnum Peat Moss Plus

With all the benefits of peat moss plus an added organic wetting agent, Black Gold® Peat Moss Plus is comprised of 100% Canadian sphagnum peat moss, the best all-purpose natural soil conditioner. It is particularly suited to acid-loving plants and can slightly lower the pH of more alkaline soils.



Item #	Desc	UPC	Vendor	CS/UOS	Location
80320005	8 qt.	064277124821	1410403.Q08P 8/8		National

Natural & Organic Potting Soil w\ Resilience™

Made from the finest ingredients and OMRI Listed for organic gardening, it is recommended for containers and raised beds. Enriched with earthworm castings, it contains a mix of peat moss and compost in addition to perlite and pumice to ensure good aeration. This product contains Resilience™ for stronger stems and improved root mass.



Item #	Desc	UPC	Vendor	CS/UOS	Location
80320019	8 qt.	064277063083	1402040.Q08P 8/8		National
80320021	16 qt.	064277063168	1402040Q16U	120/4	National

All Purpose Potting Soil with Resilience™

Nutrient-rich blend of peat moss, earthworm castings, compost and perlite/pumice is great for indoor and outdoor container plantings. It provides superior moisture retention, excellent drainage and is specially formulated with a controlled release fertilizer that feeds plants for up to six months. This potting soil contains Resilience™ for stronger stems and improved root mass.



Item #	Desc	UPC	Vendor	CS/UOS	Location
80320013	8 qt.	064277123084	1410102.Q08P 8/8		National
80320015	16 qt.	064277123169	1410102.Q16U	120/4	National
80320016	1.0 cu. ft.	064277123107	141010-CFL001P	70/70	East
80320018	2.0 cu. ft.	064277123206	1410102-CFL002P	40/40	National

Cactus Mix

A fast-draining medium formulated for succulent plants, Black Gold® Cactus Mix is the first step in creating your own garden oasis. It contains a balanced blend of perlite/pumice, earthworm castings and compost to encourage healthy growth while ensuring ample aeration and drainage that most cacti, bromeliads and succulents require to thrive.



Item #	Desc	UPC	Vendor	CS/UOS	Location
80320003	8 qt.	064277124807	1410602.Q08P 4/4		National
80320043	1cf	029973133690	1410602.CFL001P 63/63		West



Perlite

Used to improve the drainage and aeration of any growing medium, perlite is a lightweight, expanded volcanic rock. Its high porosity also makes it suitable for rooting cuttings. Wet before using to prevent airborne dust.



Item #	Desc	UPC	Vendor	CS/UOS	Location
80320035	8 qt.	029973123494	1490102.Q08P 8/8		National

Orchid Mix

Recommended for terrestrial to semi-terrestrial orchids, Black Gold® Orchid Mix is a premium quality special blend of small bark, peat moss and perlite/pumice. It contains added lime, to regulate pH and is highly recommended for Cymbidium, Paphiopedilum, and Phaius orchid species, among others.

Item #	Desc	UPC	Vendor	CS/UOS	Location
80320004	8 qt.	064277124814	1411402.Q08P 8/8		National

African Violet Mix

Picky African violets thrive in this blend of peat moss, compost, perlite/pumice and earthworm castings. African Violet Mix maintains a good balance between porosity and organic matter for happy, blooming plants with beautiful foliage. It is also suited to Gloxinia, Sinningia, Streptocarpus and other gesneriads and sensitive container plants.

Item #	Desc	UPC	Vendor	CS/UOS	Location
80320002	8 qt.	064277124081	1410502.Q08P 8/8		National

Just Coir

Just What The Name Implies, Just Coir, Actually Coconut Coir Pith, Highest Quality Coir Available, Rinse It To Reduce Salts & Then Reconstitute It From An Awkward Difficult To Use Compressed Bale Into A More User Friendly Ready To Use Product.

Item #	Desc	UPC	Vendor	CS/UOS	Location
80320007	2 cf.	029973123494	1490102.Q08P 40/40		National

Earthworm Castings

This enriching soil amendment is great for use as a top-dressing or can be added to water to make a rich "casting tea."



Item #	Desc	UPC	Vendor	CS/UOS	Location
80320008	8 qt.	064277322166	1490302.Q08P 4/4		National



Natural & Organic Potting Soil



Approved for organic gardening. Contains a rich blend of organics to produce healthy container plantings for indoor and outdoor growing. This product contains Resilience™ for stronger stems and improved root mass.

Item #	Desc	UPC	Vendor	CS/UOS	Location
80320085	1 cu. ft.	066807202894	4005103	70/70	East

Premium Topsoil

This premium topsoil will add much-needed organic matter to any garden soil or landscape planting requiring enrichment. It is also ideal for starting or top-dressing lawns or filling low spots in the landscape or garden.

Item #	Desc	UPC	Vendor	CS/UOS	Location
80320089	1 cu. ft.	066807201705	6000106	70/70	East

Premium Natural & Organic Compost Blend

Formulated for organic gardening, this is a rich blend with added nutritive benefits. It will enrich any garden bed or landscape planting, from bedding annuals, perennials, and vegetables to trees and shrubs.

Item #	Desc	UPC	Vendor	CS/UOS	Location
80320091	1 cu. ft.	066807201699	4005108	70/70	East

Garden Manure Blend

This rich manure blend is best used in annual and perennial flower beds, vegetable gardens, and for enriching landscape areas around shrubs, trees, and lawns.

Item #	Desc	UPC	Vendor	CS/UOS	Location
80320090	1 cu. ft.	066807312104	4000455	70/70	East

Sunshine® #4

Recommended where high air capacity and fast drainage are needed: during winter months, with water and salt sensitive crops, or where frequent leaching is required.



Item #	Desc	UPC	Vendor	CS/UOS	Location
80320134	3.8 cu. ft.	064277074447	504.CFC003.8P	30/30	East

Professional Potting Mix

An all-purpose potting mix based on our professional formulation used by commercial growers, Fafard® Professional Potting Mix is a top-quality peat-based blend recommended for all indoor and outdoor container plantings. This product contains Resilience™ for stronger stems and improved root mass.

Item #	Desc	UPC	Vendor	CS/UOS	Location
80320082	1 cu. ft.	066807202900	6700104	70/70	East
80320083	2 cu. ft.	066807202917	6400204	40/40	East

Ultra Container Mix with Extended Feed

A rich, ready-to-use all purpose container mix is recommended for a wide variety of bedding and potted plants grown indoors and out. It is fortified with a slow-release fertilizer that continues to feed plants for up to six months, Contains Resilience™ for stronger stems and improved root mass and MoisturePro water-holding crystals to help maintain moisture.

Item #	Desc	UPC	Vendor	CS/UOS	Location
80320087	1 cu. ft.	066807202924	4705106	70/70	East
80320088	2 cu. ft.	066807202931	4405206	40/40	East

Ultra Potting Mix with Extended Feed

A rich, ready-to-use potting mix recommended for a wide variety of bedding and potted plants grown indoors and out. It is fortified with a slow-release fertilizer that continues to feed plants for up to six months. This product contains Resilience™ for stronger stems and improved root mass.

Item #	Desc	UPC	Vendor	CS/UOS	Location
80320079	1 cu. ft.	066807202955	4705101	70/70	East
80320080	2 cu. ft.	066807202962	4405201	40/40	East

Ultra Outdoor Planting Mix

Rich in organic matter, this high-quality planting mix has been formulated for garden and landscape planting. It contains Canadian sphagnum peat moss and aged pine bark to add structure and needed organic matter to clay-rich or sandy soils.

Item #	Desc	UPC	Vendor	CS/UOS	Location
80320086	1 cu. ft.	066807202948	4705105	70/70	East



Sheet Moss Preserved - Fresh Green

Flat, thin sheets of natural moss. Preserved and color enhanced for lasting beauty. Ideal for covering soil and dressing container plants. Clean and easy to use and allows soil to retain moisture longer. Excellent for dressing orchids.



Item #	Desc	UPC	Vendor	CS/UOS	Location
80230509	2 oz. 110 cu. in.	759834215097	21509	12/12	National
80230001	8 oz. 300 cu. in.	759834215127	21512	10/10	National
80230520	5 lb. Bulk 1560 cu. in. Box	759834215080	21508	1/1	National

Preserved Spanish Moss

Dust free Spanish moss preserved to remain soft and supple for your use as a soil topper, in floral arrangements and craft projects.



Item #	Desc	UPC	Vendor	CS/UOS	Location
80230016	8 oz. Natural 265 cu. in.	759834269144	26914	10/10	National
80230507	120 cu. in.	759834269007	26900	12/12	National

Preserved Reindeer Moss

Softened and color enhanced for lasting beauty. Ideal for covering soil and dressing container plants. Clean and easy to use and allows soil to retain moisture longer.



Item #	Desc	UPC	Vendor	CS/UOS	Location
80230437	Chartreuse 120 cu. in.	075983421708	21708	12/12	National
80230007	Chartreuse 8oz. 326 cu. in.	759834216698	21669	10/10	National
80230009	Forest 8oz. 326 cu. in.	759834217572	21757	10/10	National

Orchid Bark

Excellent propagation and potting media for orchids. Ideal soil cover for indoor and outdoor container plants. Great for air plants, epiphyte orchid species that grow on branches above the rainforest floor. Provides a natural growing environment and moisture retention systems that will not suffocate delicate root systems.



Item #	Desc	UPC	Vendor	CS/UOS	Location
80230011	8 oz. 4qt. Bag	759834231141	23114	8/8	National

Preserved Fresh Green Forest Moss

SuperMoss Forest Moss is ideal for lining baskets, window boxes and wire baskets. Perfect for a grassy moss look around plant bases and above soil. Easy to use and the perfect finishing touch to any floral creation.



Item #	Desc	UPC	Vendor	CS/UOS	Location
80230511	120 cu. in.	759834253204	25320	12/12	National
80230014	8 oz 325 cu. in.	759834253228	25322	10/10	National

Moss Mix Best Sellers

SuperMoss Moss Mix comes in our elegant window box retail display. It is a collection of our best selling mosses so you can mix and match, experiment with new styles and get a feel for the different types of our premium quality mosses. Includes: Spanish Moss in Grass Green, Reindeer Moss in Chartreuse, Sheet Moss and Lichen Parmelia with tufts of Fuchsia Reindeer Moss in the center! All included mosses and lichens are in their natural form. SuperMoss Moss Mix is a great product for decorative purposes and for terrariums or crafts.



Item #	Desc	UPC	Vendor	CS/UOS	Location
80230726	325 cu. in.	759834233107	23310	12/12	National



Instant Green Mat

Green mountain moss. Easy to cut into any size or shape. Cover almost anything you can imagine.



Item #	Desc	UPC	Vendor	CS/UOS	Location
80230010	18"x48"	759834224303	22430	12/12	National

Orchid Sphagnum Moss

Orchid and Nursery Sphagnum Moss is a premium grade, long fiber and long-lasting sphagnum. Its long fibers and superior water retention properties make it ideal for lining hanging baskets and using as soil cover in window boxes and house plants. It makes for an excellent soil conditioner or top layer on potted plants like Orchids!



Item #	Desc	UPC	Vendor	CS/UOS	Location
80230217	Mini Bale 1 lb	759834223252	22325	12/12	National
80230019	3.5 lb	759834223306	22330	6/6	East



Butterfly Clips

SuperMoss Orchid and Plant Clips are a garden staple. They're perfect for orchids, vines, and climbing plants not to mention hair!

Item #	Desc	UPC	Vendor	CS/UOS	Location
80230200	10pc	064277123169	1410102.Q16U	120/4	East

White Sand Jar

A versatile floral and garden top dressing that can be used in clear vases, centerpieces, terrariums, succulent gardens, fairy gardens, and even potted plants! Our sand comes in a resealable jar which is perfect for people who only need a small touch. We also carry larger sizes for large applications. The sand is child, pet, and environmentally safe. It is biodegradable yet perfectly suitable for outdoor applications.



Item #	Desc	UPC	Vendor	CS/UOS	Location
80230940	12 oz.	759834243106	24310	12/12	National

Orchid Potting Bark

A custom blend of natural Douglas-fir tree bark, organic moss & river sand. We designed this blend specifically to the needs of wholesale orchid growers in California. Its pH makes it an ideal potting medium for orchids. It allows for great oxygenation and drainage of water so that the orchid's roots have constant access to both water and oxygen. This mimics an orchid's natural environment and helps them grow to their full potential.



Item #	Desc	UPC	Vendor	CS/UOS	Location
80230198	4 qt.	759834224303	23115	8/8	National

Koekedama Sphagnum Hanging Basket

Long-lasting Preserved Moss! Japanese Gardening: Looks beautiful with flowering plants! Strong woven design that will last for years. Naturally absorbent and ideal for hanging plants. Chain included.



Item #	Desc	UPC	Vendor	CS/UOS	Location
80230617	4" Green Moss	759834293460	29346	6/6	National
80230618	6" Green Moss	759834263484	29348	6/6	National
80230620	6" Sphagnum	759834293491	29349	6/6	East

Spanish Moss

It grows in a swirly, spaghetti-like fashion and makes for an excellent touch to floral displays, creative projects, and your garden. Our product is responsibly procured and comes in its natural color as well as a variety of enhanced colors to match your home decor. Our product is durable and reliable to provide long-lasting beauty. It is ideal for covering soil or dressing container plants, bulbs & orchids. Spanish Moss is also a great natural fill for gift baskets. Cleaned before packaging to remove small particles.



Item #	Desc	UPC	Vendor	CS/UOS	Location
80230015	325 cu. in.	064277123206	1410102.CFL002P	10/10	National



Forest Moss Dried Natural

This moss works great above and below the soil! Dried Forest Moss is perfect for a more grassy moss look around plant bases and above the soil.



Item #	Desc	UPC	Vendor	CS/UOS	Location
80230145	8 oz 325 cu. in.	759834215776	21577	10/10	West

Lichen Parmelia Natural Grey

Branched Lichen Parmelia makes a great off-season fireplace decor used as an accent alongside firewood. Lichen has natural and unique variations in size and texture to create natural beauty only found in nature.



Item #	Desc	UPC	Vendor	CS/UOS	Location
80231135	180cu in	759834235309	23530	12/12	West

Moss Mix Best Sellers

Moss Mix is a collection of our best-selling mosses so you can mix and match, experiment with new styles and get a feel for the different types of our mosses. Our Moss Mix is a variety of the following mosses and lichens: Spanish Moss in Grass Green, Reindeer Moss in Chartreuse, Sheet Moss and Lichen Parmelia with tufts of Fuchsia Reindeer Moss in the center! SuperMoss Moss Mix is a great product for decorative purposes and for terrariums or crafts.



Item #	Desc	UPC	Vendor	CS/UOS	Location
80230727	325 cu. in.	759834233121	23312	10/10	West



Orchid Sphagnum Moss Dried Natural

Orchid and Nursery Sphagnum Moss is a premium grade, long fiber and long-lasting sphagnum. Its long fibers and superior water retention properties make it ideal for lining hanging baskets and using as soil cover in window boxes and house plants. Sphagnum helps you take the guesswork out of watering your garden plants by absorbing up to 18 times its weight in water.



Item #	Desc	UPC	Vendor	CS/UOS	Location
80230216	325 cu. in.	759834223016	22301	10/10	West
80230722	0.35lb Bale	759834223245	22324	12/12	West

Spanish Moss

Preserved Spanish Moss is a company staple. It grows in a swirly, spaghetti-like fashion and makes for an excellent touch to floral displays, creative projects, and your garden.



Item #	Desc	UPC	Vendor	CS/UOS	Location
80230504	120 cu. in. Grass	759834269021	26902	12/12	West
80230306	200 cu. in. Coffee	759834269724	26972	10/10	West



Reindeer Moss

Reindeer Moss is one of our top selling mosses for floral decor. It adds natural accents to any floral arrangement. Choose from a variety of lush colors and pair your moss perfectly with your flowers' natural colors to give them true definition.

Item #	Desc	UPC	Vendor	CS/UOS	Location
80230435	120 cu. in. Natural	075983421702	21702	12/12	West
80230008	8oz Natural 325 cu. in.	759834217220	21722	10/10	West
80230436	120 cu. in. Forest	075983421703	21703	12/12	West
80231010	2oz. Fuchsia 120 cu. in.	759834231646	23164	12/12	West



SHOW MORE, SELL MORE!

Make it easier for your customers to buy more. Tier benching provides a clean and attractive display and allows you to double your display area.

SAVES WORK, TIME AND MONEY

Enhance Indoor and Outdoor Merchandise

- Benchmaster holds up to 50% more plant material than conventional wood displays
- Creates a clean and professional look

Strong, Durable and Long Lasting

- Molded from tough, high-density, UV stabilized, post consumer recycled plastic
- Will not rot, rust or corrode
- Stains and liquids will not absorb like wood
- Non-porous surface cleans up by hosing it off

Easy Setup and Teardown

- Snap-together design will save time and money
- No tools required
- Change an entire floor plan in minutes

People Friendly

- No splinters, no sharp edges
- Stable and safe to shop and work

Item #	Description
36-2035	2' x 8' BenchMaster Bench
36-2040	3' x 8' BenchMaster Bench
36-2030	16" x 8' BenchMaster Bench
36-2140	1/2 of 36" Round Bench
36-2150	1/2 of 48" Round Bench
36-2160	1/2 of 60" Round Bench

Item #	Description
36-2045	12" Plastic Leg
36-2046	18" Plastic Leg
36-2050	24" Plastic Leg
36-2060	30" Plastic Leg
36-2065	36" Plastic Leg
36-2058	Plastic Collar*

Unlimited configuration & sizes

- Make it any size or shape and move it anywhere
- Season to season, department to department



Caster Bars

*Use plastic collars for stability for multi-tier displays.



LAWN CARE & SEED

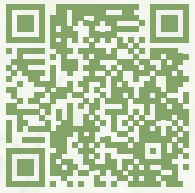
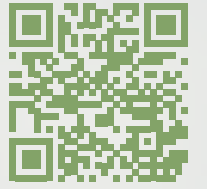

CHECK OUT OUR
CLEARANCE ITEMS!

DROP SHIP VENDORS

Jonathan Green

Minimum orders:

CT,DE,IL,IN,KY,Long Island, MA, MI,NJ,NY,OH, PA, VT - PPD \$1,250

MD,ME,MN,NH,WI - PPD \$1,450

NC,TN,VA,WV - PPD \$1,500

KY - PPD \$1,700

Orders under minimum \$ will receive a \$150 delivery charge

\$35 fuel charge per order

Limestone does not count towards delivery minimums



Griffin Greenhouse Retail WAREHOUSE Shipping Map

We are now shipping nationwide!

NATIONAL



2024

Refer to location key:

National items are stocked nationally
 Select items are sold East or West only; no exceptions

8" Kaleidoscope Planter

Premium plastic modular planter can be displayed individually each planter has a removable saucer ideal for succulents or shallow rooted planted.

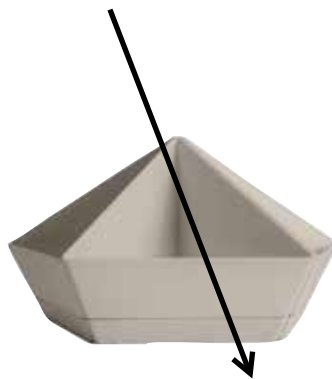

Item #	Desc	UPC	Vendor	CS/UOS	Location
80282643	Vanilla Bisque	770932844170	KDP08000A58	6/6	National

Where is the pricing?

1. Scan QR code on Chapter Pages to see pricing on Griffins.com
2. Contact your Griffin Sales Representative
3. Call into Griffin Customer Service 800.888.0054





Wildflower Blanket

Easy to plant Wildflower Seeded Blanket in a roll. Just unroll, cut to size and water; It's that simple! An environmentally- mixture of perennial and annual flower seeds, natural fertilizer and mulch.



Item #	Desc	UPC	Vendor	CS/UOS	Location
82380017	10sqft	12783253252	25325	8/8	East



Ultra wildflower mixes are a combination of seed, fertilizer and mulch all in one package. It has a pre-measured blend of perennials and annuals, it spreads easily and absorbs moisture quickly. Comes in a resealable bag and will cover 50 square feet area.

Ultra Wildflower Sun & Shade (A)

Item #	Desc	UPC	Vendor	CS/UOS	Location
82380018	12pk 1.75lb	12783443257	44325	12/12	East

Ultra Wildflower Shady (B)

Item #	Desc	UPC	Vendor	CS/UOS	Location
82380020	12pk 1.75lb	12783443455	44345	12/12	East

Ultra Wildflower Butterfly & Hummingbird (C)

Item #	Desc	UPC	Vendor	CS/UOS	Location
82380022	12pk 1.75lb	12783443530	44353	12/12	East

Straw Blanket

Ultra StrawBlanket Lawn Germination Blanket is the all-natural and easy way to protect seedlings while facilitating growth. Processed straw and seeding mulch protects seedlings while facilitating new growth. Does not contain grass seed.



Item #	Desc	UPC	Vendor	CS/UOS	Location
82380025	100sqft	012783250350	25035	9/9	East
82380026	200sqft	012783250367	25036	9/9	East



Lawn Patch Bag

Helps Repair Bare spots. 100 Sq Ft Of Coverage. Spreads easier and absorbs moisture faster than any other combination product.

Item #	Desc	UPC	Vendor	CS/UOS	Location
82380010	5lb Sun & Shade	012783000177	34332	10/10	East
82380009	5lb Shady	012783000078	34322	10/10	East
82380008	5lb Sunny	012783000061	34321	10/10	East

Ultra Lawn Patch

Uses all natural ingredients from plant extract plus seaweed and kelp: a premium blend of lawn seed, and granular recycled paper mulch used in combination to create an all - in - one lawn patch repair package.



Item #	Desc	UPC	Vendor	CS/UOS	Location
82380003	5lb.	012783453324	45332	5/5	East
82380004	20lb	012783423327	42332M	12/12	East

Ultra Nu-Straw Bale

Amturf Ultra Nu-Straw is a twice-cut, processed straw mulch that provides erosion protection on slopes, heavy washout, and windy areas. Ideal straw for seeding, it includes a bonding agent that gives straw a tackiness which holds it together and protects seed from erosion and birds. Speeds up germination and holds water to reduce water evaporation. Safe for pets and children. Does not contain grass seed.



Item #	Desc	UPC	Vendor	CS/UOS	Location
82380027	2.8cuft	12783250404	25040	40/1	East

2024



Moss Max[®] Lawn Granules

Kills lawn moss quickly, see results in hours. Turns lawns a deep green. Contains no fertilizer for no excess growth and less mowing. Applies easily with standard lawn spreaders.

Not for sale in AK, CA, DC, HI, PR

Item #	Desc	UPC	Vendor	CS/UOS	Location
80100030	6 lb. Shaker	037321607250	60725	9/9	National
80100125	20 lb. Bag	037321607281	60728	1/1	National



Weed Beater Complete[®]

This unique product provides both pre-emergent and post emergent control of both grassy and broadleaf weeds - including crabgrass, nutsedge, goosegrass, ground ivy and others. Systemic action from the leaves down and the roots up inhibits cell division and disrupts photosynthesis. Works equally well on cool and warm season grasses. Weed Beater Complete is a synergistic combination of prodamine and sulfentrazone. Exhibits excellent cool weather performance. 10 lb. treats up to 5200 sq. ft.

Not for sale in AK, CA, DC, HI, NY, PR

Item #	Desc	UPC	Vendor	CS/UOS	Location
80100122	10 lb.	037321604761	60476	4/4	National



Infuse[®] Lawn & Landscape Granules

2.08% Thiophanate-Methyl. Prevents and controls over 30 plant diseases, including tough to control soil borne pathogens of bulbs, annual and perennial flowers, bedding plants and ground covers, deciduous and evergreen trees and shrubs. Treats up to 5,000 sq. ft. of turf.

Not for sale in AK, HI

Item #	Desc	UPC	Vendor	CS/UOS	Location
80100123	7½ lb.	037321605140	60514	4/4	National



Annual[™] Grub Beater

One annual application is all it takes to control grubs all season long... "It's that simple!" Also kills European Crane Fly larvae, mole crickets and other turf destroying insects. Apply any time, spring through summer.

Not for sale in AK, CA, CT, DC, HI, MD, MA, VT

Item #	Desc	UPC	Vendor	CS/UOS	Location
80100105	5M	037321006039	603	4/4	National



Infuse[®]

1.55% Propiconazole (Banner[®]). Powerful systemic protection that prevents and cures. Won't wash off. Lasts up to one month. Provides broad spectrum of disease control on roses, flowers, lawns, trees and shrubs. Proven to encourage turf rooting and improve color in woody shrubs.

Not for sale in AK, HI, PR

Item #	Desc	UPC	Vendor	CS/UOS	Location
80100054	32 oz. RTS	037321001508	150	12/12	National



Moss Max[®]

Fast-acting, water-based, multi-purpose formula works within hours to kill moss, algae and lichens. Safe for use on lawns, trees, roofs, decks, patios, walkways and other structures. Will not stain or damage desirable plants. Also removes green slime. Contains 22.11% potassium soap.

Not for sale in DC, HI

Item #	Desc	UPC	Vendor	CS/UOS	Location
80100002	32 oz. RTS	037321007289	728	12/12	National



Lawn Weed Granules North

Kills over 200 types of listed weeds, including hard to kill weeds like Clovers, Dandelions and Crabgrass. Prevents weeds and crabgrass up to 6 months. Contains 24-D, Quinclorac, Dicamba, Dithiopyr.

Item #	Desc	UPC	Vendor	CS/UOS	Location
82270015	4M case 9.6 lb.	840216200593	820059B	4/4	National



Extreme Crabgrass Killer

Crabgrass killer: kills even large, hairy and smooth crabgrass. The special crabgrass solution kills to the root. Northern turfs such as rescue, perennial ryegrass, and Kentucky bluegrass.

Item #	Desc	UPC	Vendor	CS/UOS	Location
82270001	RTS 32 oz (non-neonic)	687073041194	704119A	8/8	National





Complete Brand Insect

Works above and below ground to protect your lawn, landscape and home from pests with one easy granular application. Kills listed above-ground pests like ants, fleas, ticks, chinch bugs and mosquitoes. Kills listed below-ground pests like grubs, mole crickets and European crane fly larvae. *Contains Bifenthrin, Carbaryl and other active ingredients



Item #	Desc	UPC	Vendor	CS/UOS	Location
82270115	RTS 32 oz (non-neonic)	687073003840	700384A	8/8	National
82270111	RTS 32oz	687073002805	700280B	8/8	National
82270114	Conc 40 oz (non-neonic)	687073003772	700377A	8/8	National
82270110	Conc 40 oz (neonic)	687073002706	700270B	8/8	National
82270112	10M 10lb.	687073002881	700288H	42/1	National
82270056	12.5M 10lb	687073002942	700294L	56/1	National
82270113	20M 20lb (neonic)	687073002898	700289G	24/1	National
82270057	25M 20lb	687073002959	700295H	32/1	National

24 Hour Grub Control

Excellent turf rescue formula delivers overnight results. High-efficiency granules provide 50% higher concentration, 33% less weight, and same great coverage. Kills grubs in 24 hours. Plus kills ants, billbugs, chinch bugs, crickets, cutworms, earwigs, grasshoppers, leafhoppers, millipedes, mole crickets, pillbugs, scorpions, sod webworms, sowbugs, and ticks. Active Ingredient: Dylox. **Product cannot be shipped to (CA, ME)**



Item #	Desc	UPC	Vendor	CS/UOS	Location
82270076	5M 10 lb.	687073007404	700740M	42/1	East
82270077	10M 20 lb.	687073007459	700745S	36/1	National

Season Long Grub Control

Patented 2 in 1 formula kills grubs all season long plus promotes strong roots and thicker turf. Creates a season long protective zone to kill grubs before they do damage. Apply anytime spring through late summer. Also kills mole crickets and European crane fly larvae. Suppresses chinch bugs and cutworms. NON-NEONIC version active ingredient: Lambda-cyhalothrin. Neonic version - active ingredient: Imidacloprid plus 6-0-1 fertilizer.

***Neonic versions restricted use in CT, MA, MD, ME, NY, & VT**



Item #	Desc	UPC	Vendor	CS/UOS	Location
82270074	5M 10lb non-neonic	687073007053	700705H	42/1	National
82270075	5M 12lb.	687073007107	700710M	42/1	National
82270003	10M 24lb	687073007206	700720S	36/1	National

Lawn Weed Killer -Southern & Northern Lawns

Kills over 200 broadleaf lawnweeds including Clover, Dandelion, Dollarweed, and more. Lawn weed killer kills to the root. One application will kill listed weeds and won't harm your lawn.



Item #	Desc	UPC	Vendor	CS/UOS	Location
82270093	RTS 32oz (non-neonic)	687073051100	705110A	8/8	National

Weed & Feed

Fungus Control for Lawns effectively eliminates fungal infections like brown patch, red thread, and dollar spot from your lawn. This product offers excellent disease protection with just one application. Its active ingredients provide long-lasting, residual control for up to one month.



Item #	Desc	UPC	Vendor	CS/UOS	Location
82270083	RTS 32 oz	687073012705	701270A	8/8	National
82270082	5M 10lb	687073012309	701230F	42/1	National

2 In 1 Moss & Algae Killer

BioAdvanced 2-In-1 Moss & Algae Killer & Cleaner kills moss, algae and lichen wherever it grows. It acts like 2 products in 1, treating lawns and patios plus roofs and buildings. The no-odor, non-staining formula will kill listed diseases in hours and protect for months, without harming your lawn.



Item #	Desc	UPC	Vendor	CS/UOS	Location
82270091	RTS 32oz (non-neonic)	687073047103	704710B	8/8	National

Bermudagrass

For use on cool season grasses such as Fescue, Kentucky Bluegrass and Perennial Ryegrass. Rainproof in 1 hour, treats 5,000 sqft **Not for sale in AK, HI, FL, LA, MA, ME, MN, NH, NJ, NY, ND, PR, RI, SD, & WI**



Item #	Desc	UPC	Vendor	CS/UOS	Location
82270085	RTS 32oz	687073041002	704100B	8/8	National



All In One Lawn Weed & Crabgrass Killer

BioAdvanced All-In-One Lawn Weed & Crabgrass Killer Kills Listed Lawn Weeds PLUS Crabgrass and Other Grassy Weeds without Harming Your Lawn. **Not for sale in HI and PR**



Item #	Desc	UPC	Vendor	CS/UOS	Location
82270086	RTU 24oz (non-neonic)	687073041255	704125A	12/12	National
82270084	RTS 32 oz (non-neonic)	687073040807	704080A	12/12	National
82270064	Conc 40oz (non-neonic)	687073041408	704140B	8/8	National
82270087	RTU 1 Gal (non-neonic)	687073041309	704130A	4/4	National
82270088	1.3 Gal (non-neonic)	687073041385	704138A	4/4	National

Weed & Grass Killer

The fast and powerful root kill action of BioAdvanced weed and grass killer begins working after 1 hr. Only one application is needed to kill weeds dead so they don't come back. Not all weed killers are the same. Make the switch. **Not for sale in NY.** Pending registration in CA



Item #	Desc	UPC	Vendor	CS/UOS	Location
82270102	RTU 24 oz (non-neonic)	687073041972	704197A	8/8	National
82270025	Conc 28 oz (non-neonic)	840216200555	820055B	8/8	National
82270103	RTU 1 Gal (non-neonic)	687073041989	704198A	4/4	National
82270104	RTU 1.3 Gal Power Sprayer	687073041996	704199A	4/4	National

Weed & Feed

Sold in a new eco-friendly package. Kills listed broadleaf lawn weeds including Dandelion, Clover, Chickweed and more, kills Crabgrass plus other grassy weeds, even if you've missed a Crabgrass preventer application, Micro-Feed Action improves nutrient uptake during and between feedings, feeds, greens and strengthens your lawn. Do not use on St. Augustine grass (including Floratam variety), Bahiagrass, Carpetgrass, Centipedegrass or Dichondra. **Not for sale in HI, NY or FL.** State registrations pending in CA and PR.



Item #	Desc	UPC	Vendor	CS/UOS	Location
82270152	9.6 lb.	687073048605	704860L	40/1	East
82270153	10M 24 lb.	687073048650	704865H	32/1	East

Grass & Weed with Root Kill

This product is a fast-acting herbicidal soap that eliminates unwanted vegetation. It can be used in planting beds prior to planting grass, flowers or vegetables and around ornamental flowers and mature shrubs and trees. Kills listed weeds and grasses, including Dandelion, Chickweed and others. Fast-acting!



Item #	Desc	UPC	Vendor	CS/UOS	Location
82270062	RTU 24 oz	687073072006	707200A	4/4	National
82270098	Conc 32 oz (non-neonic)	687073065008	706500A	4/4	National
82270061	RTU 1 Gal	687073072013	707201A	4/4	National
82270099	1.3 Gal (non-neonic)	687073065107	706510A	4/4	National

Lawn Weed & Disease Control

Kills listed weeds including Dandelion, Common Chickweed, Clover, and more down to the root. Fungicide controls Rust, Dollar Spot, Lichens, and more. Also kills moss, algae, and lichens in turf. Can be applied in cooler weather (down to 50 degrees) during non-traditional weeding times.



Item #	Desc	UPC	Vendor	CS/UOS	Location
82270060	RTS 24oz (non-neonic)	687073074109	707410D	4/4	National
82270059	24oz (non-neonic)	687073073102	707310D	4/4	National



Residential Push Turf Spreader

Lawn Spreader starter model has a 65 lb. capacity hopper, powder coated steel frame, adjustable gate with 30 gate settings for seed and fertilizer, and enclosed gears to withstand the elements.



Item #	Desc	UPC	Vendor	CS/UOS	Location
82210088	65lb.	023883080006	8000A	3/3	National

Spreader Hand Crank

Compatible with fertilizer, seeds and sale/ ice-melt. Easy-crank design with enclosed gears to protect from debris. Lightweight and easy to maintain.



Item #	Desc	UPC	Vendor	CS/UOS	Location
82210107	1.6L	023883087067	8706A	3/3	National



Grass-Fast Natural Roll

Traps heat and moisture to speed and increase seed germination. Also protects newly planted seed from erosion. Easier to use and more effective than straw, ideal for slopes and difficult areas. Also good for frost protection. Reusable. 200 sq. ft. coverage.



Item #	Desc	UPC	Vendor	CS/UOS	Location
82170084	4' X 50'	016069004903	EXC-200	1/1	National

Straw Blanket Roll

Biodegradable straw erosion control blanket. Straw fiber with net. Ideal for covering grass seed during germination. Also protects newly planted seed from erosion. 200 sq. ft. coverage. Product is Manufactured in United States.



Item #	Desc	UPC	Vendor	CS/UOS	Location
82170086	4' X 50'	016069004910	STR-200	1/1	National



Weed & Grass Herbicide

Dr. Earth Final Stop Weed & Grass Killer Spray is a safe alternative to synthetic sprays. OMRI listed for organic use, it is a non-selective weed & grass killer that can be used up to the day of harvest because it is made from the highest quality organics and contains no glyphosate or synthetic ingredients.



Item #	Desc	UPC	Vendor	CS/UOS	Location
81160124	128oz. RTU	749688080125	8012	4/4	West



Weed Preventer 9-0-0

Helps prevent unsightly weeds from popping up in your lawn while it nourishes the grass so that it becomes more resistant to heat, drought and other stress. And because the product is all-natural, it is safe for your family, your pets and the environment. Made from corn gluten meal.

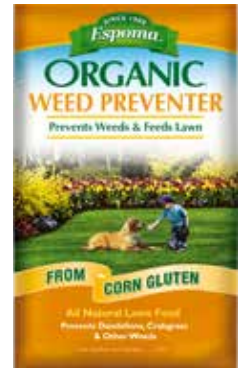

Item #	Desc	UPC	Vendor	CS/UOS	Location
80030083	25 lb.	050197052252	CGP25	1/1	East

Lightning Lime™

Treated with a natural humic acid that helps the soil and plants convert calcium into an immediately available form. Lightning Lime can work in just 6 to 8 weeks instead of the up to 14 months other lime products require. Lightning Lime is also less dusty than traditional lime products and is approved for organic gardening. One bags equivalent to five bags of conventional Lime.



Item #	Desc	UPC	Vendor	CS/UOS	Location
80030137	30 lb.	050197060301	LL30	30/1	East

GriffinExpo
SAVE THE DATES!
Virtual Expo
August 19 - October 31, 2024
In-Person Expos
August 28-29, 2024
 Silver State Pavilion at Grand Sierra
 Reno, NV (**New Location**)
September 25-26, 2024
 New Jersey Convention and Expo Center
 Edison, NJ



Fall Winterizer 8-0-5

Supplies long-lasting nitrogen, an essential nutrient that helps to promote a thicker lawn and vigorous growth. It is also fortified with potassium, a nutrient that helps the lawn recover from summer drought conditions, enhances winter hardiness and helps promote a better spring greening the following season.



Item #	Desc	UPC	Vendor	CS/UOS	Location
80030087	30 lb.	050197058308	EOFW30	1/1	East

Spring Lawn Booster 8-0-0

An affordable, chemical-free lawn program that is safe for kids and pets. All Espoma Organic Lawn Products are specifically formulated to optimize the help of the lawn, and provide 2.5 times more slow-release nitrogen (SRN) than conventional lawn programs. Fortified with extra calcium to speed up spring greening.



Item #	Desc	UPC	Vendor	CS/UOS	Location
80030084	30 lb.	050197055307	EOLB30	1/1	East

Summer Revitalizer 8-0-0

Contains Bio-tone microbes that help make nutrients more available to your lawn. These microbes will help promote faster greening, deeper roots and improved soil structure. Fortified with 2% non staining iron.



Item #	Desc	UPC	Vendor	CS/UOS	Location
80030086	30 lb.	050197057301	EOSR30	1/1	East

Lawn Food 15-0-5

Espoma Lawn Food is a premium formula designed for safe, easy lawn feeding for the home gardener as well as the professional horticulturist. It provides slow release nitrogen for extended feeding and is granular, non-burning, and easy to apply. Plus Espoma Lawn Food now contains non-staining iron, and is now enhanced with Biotone® microbes.

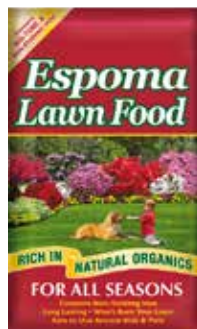

Item #	Desc	UPC	Vendor	CS/UOS	Location
80030082	20 lb.	050197053204	ELF20	1/1	East
80030081	40 lb.	050197053402	ELF40	1/1	East

All Season Lawn Food 9-0-0

Finally, an affordable, chemical – free lawn program that is safe for kids and pets. All Espoma Organic Lawn Products are specifically formulated to optimize the help of the lawn, and provide 2.5 times more slow release nitrogen (SRN) than a conventional lawn program. All Season Lawn Food also contains Bio-tone Microbes that help make nutrients more available to your lawn. These microbes will help promote faster greening, deeper roots, and improved soil structure.



Item #	Desc	UPC	Vendor	CS/UOS	Location
80030125	28 lb.	050197056281	EOLF28	1/1	East



New Lawn Starter 9-13-7

When you're planting a new lawn, don't leave your grass growing success to chance - trust ferti-lome New Lawn Starter Fertilizer to help! This balanced fertilizer is specially formulated to encourage grass seed to develop healthy roots and stems before beginning rapid growth. It's also formulated to fertilize sod, and can be used when sprouting new grass, as well.



Item #	Desc	UPC	Vendor	CS/UOS	Location
82280081	4 lb.	732221109049	10904	12/12	East
82280079	10 lb.	732221109025	10902	1/1	East
82280082	20 lb.	732221109063	10906	1/1	East
82280080	40 lb.	732221109032	10903	1/1	East

Weed-Out Lawn

When weeds sneak up in your lawn, you need ferti-lome Weed-Out Plus Lawn Fertilizer. This weed killer is post-emergent, which means it's made to apply after weeds and crabgrass have sprouted. While controlling weed growth, Weed-Out Plus Lawn Fertilizer also provides a dose of nitrogen fertilizer to strengthen your lawn. Contains Trimec herbicide.



Item #	Desc	UPC	Vendor	CS/UOS	Location
82280015	16oz Concentrate	732221105102	10510	12/12	East
82280016	32oz RTS	732221105133	10513	12/12	East
82280085	20 lb.	732221109216	10921	1/1	East
82280086	40 lb.	732221109230	10923	1/1	East

Broadleaf Weed

A pre-emergence herbicide for control of certain broadleaf weeds such as: chickweed, clover, dandelion, henbit, spurge, yellow woodsorrel (oxalis). suppression of annual grasses such as: annual bluegrass (poa annua) and crabgrass established in cool season and warm season turfgrass and landscape ornamentals.



Item #	Desc	UPC	Vendor	CS/UOS	Location
82280073	10 lb.	732221108851	10885	1/1	East

MosquitoGo

Safe for use around kids, pets, insects such as bees, butterflies, and ladybugs.

Controls mosquitoes, ants, fleas, beetles, crickets, roaches, chinch bugs, flies, gnats, and numerous other insect pests. Safe to use around children and pets when used as directed. Features a pleasant scent. Active Ingredient: Cedar Oil.



Item #	Desc	UPC	Vendor	CS/UOS	Location
82280005	10 lb.	732221100510	10051	1/1	East

Weed-Out Broadleaf Weed Control

Controls over 200 broadleaf weeds including Dandelion, Chickweed and Knotweed. See label for more. For use on Bahia, Bermuda, Zoysia, Kentucky Bluegrass, Fescue and more. See label for full list. This 10 lb. bag of granular weed killer can treat up to 5,000 square feet of lawn and turfgrass.



Item #	Desc	UPC	Vendor	CS/UOS	Location
82280087	10 lb.	732221109254	10925	1/1	East

Centipede Lawn Fertilizer 15-0-15

Prevents and correct yellow grass foliage and gives your lawn the fast super green you desire. Provides essential nutrients with slow release nitrogen to reduce the risk of nitrogen burn. The 20 lb. bag covers up to 5,000 square feet of lawn. See label to recommended grass types.



Item #	Desc	UPC	Vendor	CS/UOS	Location
82280060	20lb.	732221107670	10767	1/1	East

All Seasons II 16-0-8

For All Seasons II Lawn Food Plus Crabgrass and Weed Preventer is a powerful tool in your yearly lawn care arsenal. An application feeds warm and cool season grasses for up to 5 months, creating a stronger root system for your lawn. All Seasons II also provides weed control for a large variety of grassy and broadleaf weeds. Apply once and your grass will thank you all season long.



Item #	Desc	UPC	Vendor	CS/UOS	Location
82280138	20 lb.	732221119147	11914	1/1	East
82280139	40 lb.	732221119246	11924	1/1	East

F-Stop Fungicide

Apply ferti-lome F-Stop Fungicide Granules during the growing season for diseases such as brown patch, powdery mildew, pink snowy mold, dollar spot, summer patch, and many others. F-Stop contains Eagle fungicide, which both prevents and controls fifteen different diseases in both established lawns and ornamental turfs. One application protects for up to 4 weeks.



Item #	Desc	UPC	Vendor	CS/UOS	Location
82280148	10 lb.	732221127708	12770	1/1	East

MosquitoGo Yard Fogger

When you have a big problem with insects like mosquitoes and biting flies, you need a powerful tool like ferti-lome MosquitoGo Yard Fogger. MosquitoGo Fogger contains a combination of ingredients that help provide rapid elimination of many nuisance insects. It works best on yards, porches, patios, screens, window frames, and doors.



Item #	Desc	UPC	Vendor	CS/UOS	Location
82280003	16 OZ	732221100428	10042	12/12	East

F-Stop Lawn & Garden Fungicide

Controls damaging diseases like Black Spot, Rust, Blights and more. See label for full list. Designed for outdoor use on roses, flowers, ornamental shrubs, fruits, nuts, vegetables and lawns. Most effective as a fungicide when it is used to prevent diseases before they appear.



Item #	Desc	UPC	Vendor	CS/UOS	Location
82280059	RTS 32 oz	732221107656	10765	12/12	East

ferti·lome

Over-The-Top II Grass Killer

Repels Moles and other small animals from your lawn, garden and flower bed. Can be used in other areas such as ornamental turf, golf courses and athletic fields.



Item #	Desc	UPC	Vendor	CS/UOS	Location
82280008	RTS 32OZ	732221103184	10318	12/12	East

Over-The-Top II Grass Killer

Controls Annual and Perennial Grass Weeds. Systemic selective broad spectrum post-emergent herbicide that can be sprayed over desired plants listed to control annual and perennial grasses.



Item #	Desc	UPC	Vendor	CS/UOS	Location
82280012	Conc 8oz	732221104341	10434	12/12	East

Decimate Weed & Grass Killer

This non-selective herbicide kills weeds, grass and some woody plant species. Results can be seen in 24 to 72 hours. Works best in temperatures over 85 degrees. The product is rainfast after 30 minutes to 4 hours depending on sun and temperature.



Item #	Desc	UPC	Vendor	CS/UOS	Location
82280112	16oz Concentrate	732221112612	11261	12/12	East
82280113	32oz Concentrate	732221112629	11262	12/12	East

Weed-Out Nutsedge Control

This is a nonselective herbicide. The product kills all grass and weeds it makes contact with. Great for use on Mulch and around Planters, Raise Beds, Driveways, Patios, Foundations and Fences.



Item #	Desc	UPC	Vendor	CS/UOS	Location
82280109	16oz Conc	732221112544	11254	12/12	East
82280110	RTS 32 OZ.	732221112575	11257	12/12	East
82280111	RTU 32 OZ.	732221112582	11258	12/12	East

Grass & Weed Killer

This is a nonselective herbicide. The product kills all grass and weeds it makes contact with. Great for use on Mulch and around Planters, Raise Beds, Driveways, Patios, Foundations and Fences. It can be used in planting beds prior to planting grass or flowers.



Item #	Desc	UPC	Vendor	CS/UOS	Location
82280170	RTU 32 OZ	732221161061	16106	12/12	East
82280169	32oz Concentrate	732221161030	16103	12/12	East
82280171	RTU 1 GL	732221161078	16107	4/4	East

Weed-Out w/ Crabgrass Killer

Selective weed killer controls over 200 grassy and broadleaf weeds including Crabgrass and Foxtail. Intended for use on established lawns including Bermuda, Buffalo, Kentucky Bluegrass and more. For best results apply in spring or early summer when weeds are small and actively growing.



Item #	Desc	UPC	Vendor	CS/UOS	Location
82280098	16oz Conc	732221110304	11030	12/12	East
82280099	RTS 32 OZ	732221110311	11031	12/12	East
82280101	RTU 32 OZ	732221110366	11036	12/12	East

Weed Free Zone

Controls over 80 broadleaf weeds including Clover, Spurge, Chickweed, Thistle, see label for more. Safe on Kentucky Bluegrass, Bermudagrass, Bahiagrass, Zoysiagrass and more. See label for full list. The rapid and effective weed killer provides evidence of injury within hours of application.



Item #	Desc	UPC	Vendor	CS/UOS	Location
82280022	RTS 32 OZ	732221105270	10527	12/12	East
82280023	RTU 32 OZ	732221105287	10528	12/12	East
82280025	RTU 1 GL	732221105324	10532	4/4	East
82280019	8 oz concentrate	732221105232	10523	12/12	East
82280020	16 oz concentrate	732221105249	10524	12/12	East
82280021	32 oz concentrate	732221105256	10525	12/12	East

Hi-Yield®



Indoor/Outdoor Broad Use Insecticide

Indoor Insects Controlled: Termites, Fleas, Ticks, Carpet Beetles, Cockroaches, Waterbugs, Palmetto Bugs, Ants, Silverfish, Firebrats, Spiders, Crickets, Millipedes, Centipedes, Mites, Weevils, Beetles, Flies and Carpenter Ants.

Item #	Desc	UPC	Vendor	CS/UOS	Location
82280212	8 oz	732221320086	32008	12/12	East
82280213	16 oz	732221320093	32009	12/12	East

38 Plus Turf Termite & Ornamental Insect Control

Controls home invading insects, lawn insects, insects on ornamentals plus trench and fence post termite recommendations.

Item #	Desc	UPC	Vendor	CS/UOS	Location
82280208	8 oz	732221313309	31330	12/12	East
82280209	16 oz	732221313316	31331	12/12	East

2, 4-D

This product will kill or control many Broadleaf Weeds in addition to many other noxious plants susceptible to 2, 4-D.

Item #	Desc	UPC	Vendor	CS/UOS	Location
82280185	16 oz	732221214149	21414	12/12	East

Grub Free Zone

Other pests controlled (including the larvae of japanese beetle, oriental beetle, chafers, asiatic garden beetle, may or june beetles, and black turfgrass ateniensis) and mole crickets.

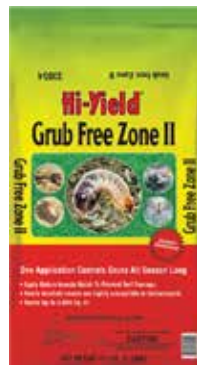

Item #	Desc	UPC	Vendor	CS/UOS	Location
82280287	15 lb.	732221330641	33064	1/1	East

Bug Blaster II

Provides broad spectrum control of insect pests in Lawns, Landscapes, Perimeter around Homes and Buildings. 11.5 lb. bag treats up to 5,000 sq. ft. 23 lb. bag treats up to 10,000 sq. ft. controls fireants, fleas, ticks, mole crickets, chinch bugs, European crane flies, scorpions and other listed insect pests.



Item #	Desc	UPC	Vendor	CS/UOS	Location
82280295	23 lb.	732221333277	33327	1/1	East

Turf & Ornamental

Use in ornamental landscape areas, established lawns and ornamental turf. Can be applied up to 4 weeks later than other preemergence crabgrass preventers.



Item #	Desc	UPC	Vendor	CS/UOS	Location
82280281	12 lb.	732221330306	33030	1/1	East

Kill-A-Bug II Lawn

For use in lawns, around house foundation, under shrubbery and other ornamental recreational turf grass areas. Provides control of armyworms, ants, ticks, chinch bugs, crickets, grasshoppers, spiders, scorpions, cockroaches, european crane fly larvae and many other listed insects.



Item #	Desc	UPC	Vendor	CS/UOS	Location
82280267	10 lb.	732221323155	32315	1/1	East
82280268	20 lb.	732221323162	32316	1/1	East

Bug Blaster Plus

An insecticide for above and below ground insects in lawns, flower beds, ornamentals, trees and shrubs. Apply early to kill grubs and crane fly larvae or apply when above ground insects are present.



Item #	Desc	UPC	Vendor	CS/UOS	Location
82280275	20 lb.	73222324060	32406	1/1	East



Rodent Stopper Shaker Jug

The key to keeping rats and mice out of gardens, homes and structures is prevention. That's why we created our Rodent Stopper. Our humane Rodent Stopper can be used indoors or out as it creates a sensory barrier that works by smell, taste and feel. Apply Rodent Stopper every 30 days, regardless of weather or water.



Item #	Desc	UPC	Vendor	CS/UOS	Location
81490221	2.5lb.	813935000300	RS-G-001	4/4	National

PULVERIZE Weed & Grass Killer Gallon with Trigger

Pulverize® Weed and Grass Killer is a fast acting, weed, grass, algae and moss killer. Incidental over spray will not stain concrete or pavement. Pulverize Weed and Grass Killer is a non-selective herbicide that controls many common annual weeds. Pulverize Weed and Grass Killer suppresses the growth of some bi-annuals and perennial weeds.



Item #	Desc	UPC	Vendor	CS/UOS	Location
81490163	32 oz RTS	813935009570	PWG-C-032	6/6	National
81490219	1 Gal with Trigger	813935009624	PWG-UT-128	4/4	National

2024

PULVERIZE Weed Brush & Vine Killer

The Pulverize Weed, Brush & Vine Killer formula is a powerful, fast and effective alternative to those other brand name weed killers. Destroy pesky weeds, brush and vines down to the roots and see results in just a few hours!



Item #	Desc	UPC	Vendor	CS/UOS	Location
81490170	32oz RTS	813935009594	PWBV-C-032	6/6	National
81490166	32oz with Trigger	813935009549	PWBV-U-032	6/6	National
81490217	1 Gal with Trigger	813935009631	PWBV-UT-128	4/4	National

Pulverize Weed Killer for Lawns

Pulverize® Weed Killer for Lawns uses the active ingredient iron to selectively control/suppress broadleaf weeds growing in lawns. Dogs, pets and people can enter the area after product has dried. Works fast, even in cold weather, and results will be seen in hours.



Item #	Desc	UPC	Vendor	CS/UOS	Location
81490156	32oz RTS	813935009563	PW-C-RTS	6/6	National
81490152	32oz with Trigger	813935009501	PW-U-032	6/6	National
81490220	1 Gal with Trigger	813935009617	PW-UT-128	4/4	National

EMAIL PROGRAMS

Connect with us!

We offer several topical e-mail programs for growers and retailers. Tailor your subscriptions to meet your unique needs and interests, from technical tips to product specials and much more.

Visit www.griffins.com to subscribe!

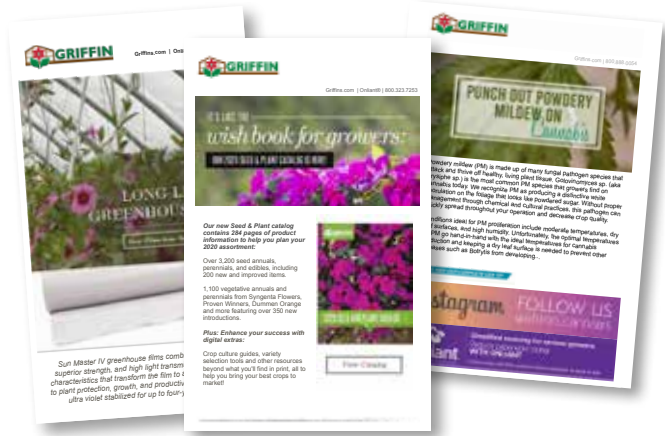



Tree Saver

A granular soil amendment with beneficial bacteria and mycorrhizal fungi. For planting and transplanting trees, shrubs and flowers. Contains beneficial rhizosphere bacteria, mycorrhizae, kelp meal and humic acids to improve soil and plant health. Contains a total of 150 - 3oz packs



Item #	Desc	UPC	Vendor	CS/UOS	Location
80350442	150 X 3oz	88685565694	2756658	1/1	East



Black Beauty Seedroll

Contains black beauty seed and starter food. Biodegradable mat grows seed in 10-5 days. Grows well in sunny or shady areas. Protects seed from erosion and wildlife. Covers 50 sq ft.



Item #	Desc	UPC	Vendor	CS/UOS	Location
81430212	50 sq ft	079545104108	10410	6/6	East



All Purpose Fertilizer

Milorganite fertilizer is one of the oldest branded fertilizers on the market today. It is composed of heat-dried microbes that have digested the organic matter in wastewater. It is non-burning, does not need to be watered in, has iron for greening and has been used on golf courses since 1926.



Item #	Desc	UPC	Vendor	CS/UOS	Location
81580002	5 lb.	465396200502	MILOR05	10/10	East
81580003	32 lb.	465396403241	MILORG32	63/7	National

Black Beauty Patcher

Quickly patch and repair stubborn bare spots and pet-damaged areas in the lawn. An all-in-one lawn patch solution contains Black Beauty Ultra grass seed, coconut coir and rice mulch, and starter lawn fertilizer.



Item #	Desc	UPC	Vendor	CS/UOS	Location
81430225	130SF JUG	079545104504	10450	6/6	National

2024



Starter Fertilizer 10-0-0

Monterey Starter Fertilizer encourages root development and is excellent for gardens, ornamental plants, bedding plants, lawns, trees, shrubs, vegetables, and fruit trees. Additionally, this fertilizer includes calcium, which helps avert the blossom end rot issue commonly encountered in tomatoes.



Item #	Desc	UPC	Vendor	CS/UOS	Location
80820346	QTS	022179105386	LG 7368	10/10	East



New American Lawn® Hand Spreader

Hand Spreader is ideal for spreading grass seed, fertilizers, and ice melters. Easy and comfortable to use, the ergonomic handle allows the weight to be supported by the operator's forearm, preventing back injuries. The spreader is fully assembled and is made of lightweight, corrosion resistant materials. Great to use on lawns, gardens, driveways and sidewalks.

Item #	Desc	UPC	Vendor	CS/UOS	Location
81430188	50 sq ft	079545109479	10947	6/6	East



Winter Rye Grass Seed

Winter Rye is a cover crop that enriches the soil. For use in gardens, pastures and hay fields. Use as a cover crop to control erosion.



Item #	Desc	UPC	Vendor	CS/UOS	Location
81430080	5 lb	079545123918	12391	6/6	West

Black Beauty Shady Nooks™ Mixture

Especially made to survive in damp or dry shady areas. Works well under extremely dense tree shade. Contains Hard Fescue for dry areas in deep shade.



Item #	Desc	UPC	Vendor	CS/UOS	Location
81430045	3 lb.	079545119577	11957	15/15	East

Black Beauty Fall Magic

Specially formulated for successful fall seeding. This mixture is good to use on established lawns or to start new lawns. Repairs summer damage and provides an attractive, thicker, greener lawn.



Item #	Desc	UPC	Vendor	CS/UOS	Location
81430033	3 lb.	079545107659	10765	15/15	East
81430034	7 lb.	079545107680	10768	7/7	East
81430035	25lb.	079545107703	10770	1/1	East

Black Beauty Heat & Drought

Heat and Drought Resistant Grass Seed Mixture is our most heat and drought-tolerant grass seed mixture yet! It contains Texas Bluegrass and Black Beauty® turf-type tall fescues which makes it perfect for lawns located in the Transition Zone. Black Beauty® Heat and Drought Grass Seed can withstand very hot temperatures, up to 100°F, and requires less maintenance than other grass types.



Item #	Desc	UPC	Vendor	CS/UOS	Location
81430229	3 lb.	79545105143	10514	15/15	East
81430230	7 lb.	79545105150	10515	7/7	East

Black Beauty™ Grass Seed

Produces a darker-green turf naturally. With improved disease resistance and drought tolerance, Black Beauty Grass redefines what a "green-lawn" is supposed to look like! The grass leaves possess an invisible waxy coating, very similar to what you'd find on an apple which helps to preserve moisture in the leaf and wards off stress from heat, cold, wind and disease. With roots that can grow up to four feet deep into the soil, it will improve any lawn it is overseeded into. This blend grows well in clay or sandy soils and in full sun or partial shade.



Item #	Desc	UPC	Vendor	CS/UOS	Location
81430020	5 lb.	079545103187	10318	10/10	National
81430021	15 lb.	079545103170	10317	3/3	National
81430022	25 lb.	079545103156	10315	1/1	National
81430023	50 lb.	079545103163	10316	1/1	East

Black Beauty Sunny

Will provide a long-lasting lawn of the highest quality in stressful, sunny growing conditions. Survives on south facing slopes. Highest ranking endophytic turfgrass varieties deter damage from insects.



Item #	Desc	UPC	Vendor	CS/UOS	Location
81430036	1 lb.	079545108953	10895	24/24	East
81430037	3 lb.	079545108601	10860	15/15	East
81430253	3 lb.	079545108601	10861	6/6	West
81430038	7 lb.	079545108809	10880	7/7	National
81430040	25 LB.	079545108700	10870	1/1	National





Black Beauty Pacific Northwest

All-purpose grass seed mixture specifically designed for the diverse climates of the Pacific Northwest, including Washington, Oregon and Idaho. Black Beauty® Pacific Northwest Grass Seed thrives in full sun to medium-shaded lawn areas and grows an attractive, naturally dark-green lawn.



Item #	Desc	UPC	Vendor	CS/UOS	Location
81430242	3 lb.	079545103668	10364	6/6	West
81430243	7 lb.	079545103668	10366	7/7	West

Black Beauty Golden State Mix

pecially formulated for California lawns. Extreme drought and heat tolerance up to 100°F. Premium mixture of turf-type tall fescues and Texas Bluegrass. Grows dark green, drought-resistant, and highly durable lawns. Grows well in both sunny and/or shady areas.



Item #	Desc	UPC	Vendor	CS/UOS	Location
81430250	3 lb.	079545107000	10702	6/6	West
81430228	7 lb.	079545107017	10701	7/7	West

Black Beauty Dense Shade

Grows in shady areas and dry soils where other seed mixtures have failed. Contains naturally insect resistant endophytic turfgrass varieties, which helps to deter insect pests. Contains several grass types for species diversity.



Item #	Desc	UPC	Vendor	CS/UOS	Location
81430028	1lb.	079545106225	10622	24/24	National
81430029	3 lb.	079545106003	10600	15/15	East
81430252	3 lb.	079545106003	10601	6/6	West
81430030	7 lb.	079545106201	10620	7/7	National
81430032	25 lb.	079545106102	10610	1/1	East

Black Beauty™ Ultra Grass Seed

Black Beauty Ultra germinates quickly to fill in damaged lawns. This grass possesses species diversity and contains Black Beauty Tall Fescues, elite Kentucky Bluegrass and elite Perennial Ryegrass. These grasses grow a naturally dark green and beautiful lawn. This mixture has excellent heat and drought tolerance.



Item #	Desc	UPC	Vendor	CS/UOS	Location
81430024	1 lb.	079545103200	10320	24/24	East
81430013	3 lb.	079545103217	10321	15/15	National
81430251	3 lb.	079545193217	10325	6/6	West
81430026	7 lb.	079545103224	10322	7/7	National
81430027	25 lb.	079545103231	10323	1/1	National

Black Beauty Sun & Shade

Will grow a thick, dark-green lawn in both sun and partial shade areas. Wide adaptability and elite varieties make this our most popular grass seed mixture. Endophyte enhanced for improved insect resistance.



Item #	Desc	UPC	Vendor	CS/UOS	Location
81430048	1 lb.	079545120016	12001	24/24	East
81430014	3 lb.	079545120023	12002	15/15	East
81430254	3 lb.	079545120023	12008	6/6	West
81430050	7 lb.	079545120054	12005	7/7	National
81430051	15 lb.	079545120047	12004	3/3	East
81430052	25 LB.	079545120061	12006	1/1	National

Black Beauty Heavy Traffic

A hardy mixture of grasses for tough areas with hard wear. Black Beauty Tall Fescues and Perennial Ryegrass offers quick cover and excellent abrasion resistance. Use where children and pets play.



Item #	Desc	UPC	Vendor	CS/UOS	Location
81430041	3 lb.	079545109707	10970	15/15	National
81430042	7 lb.	079545110000	11000	7/7	East
81430043	25lb.	079545109806	10980	1/1	East



Lawn Moss Control

Kills lawn moss quickly. Easy to spread, small particle granules for improved performance. 50% more active ingredient per 5,000 sq. ft. bag versus other brands for superior control. Delay seeding for two weeks after application.



Item #	Desc	UPC	Vendor	CS/UOS	Location
81430122	5M	079545114572	11457	1/1	East

Lawn Fungus Control

A systemic fungicide for both preventative and curative treatments. Controls more than 20 lawn diseases including summer patch, fusarium blight, dollar spot, copper spot, red thread, rust, striped smut, pink snow mold. Easier to spread accurately for better coverage and control. You may seed with this product.



Item #	Desc	UPC	Vendor	CS/UOS	Location
81430120	5M	079545102333	10233	1/1	East

Summer Survival Insect Control plus Lawn Fertilizer 13-0-3

Controls a wide spectrum of insect pests including chinch bugs, army worms, sod webworms, ticks, ants, and over 15 other insects with Bifenthrin. Slow-release nitrogen provides a controlled release feeding. No phosphorus formula makes it great for lake and bay communities.



Item #	Desc	UPC	Vendor	CS/UOS	Location
81430016	5M	079545120115	12011	1/1	East
81430105	15M	079545120153	12015	1/1	East

Winter Survival 10-0-20

Winter survival is a high potassium (K) fertilizer that is perfectly formulated (10-0-20) for the fall season. Winter Survival helps prepare lawns for winter and protects them from spring diseases, like snow mold and red thread.



Item #	Desc	UPC	Vendor	CS/UOS	Location
81430107	15M	079545124144	12414	1/1	National
81430005	5M	079545124007	12400	1/1	National

Love Your Soil

Love Your Soil assists in breaking up clay and loosens compacted soils, which improves root penetration, grass growth, and root mass. Because hard and compacted soil is often the problem when it comes to growing a great lawn, this product is designed to help release nutrients trapped in the soil for premium grass growth.



Item #	Desc	UPC	Vendor	CS/UOS	Location
81430156	5M	079545121907	12190	1/100	West

Fast Grow Mixture

Provides a hardy turf quickly in sun and shade. This is the perfect seed mixture where the fastest results are required. Germinates in just 7-14 days!



Item #	Desc	UPC	Vendor	CS/UOS	Location
81430053	3 lb.	079545108205	10820	15/15	National
81430054	7 lb.	079545108403	10840	7/7	East
81430055	15 lb.	079545108304	10830	3/3	National
81430056	25 lb.	079545108106	10810	1/1	East

Touch-Up Tri-Rye Grass Seed Blend

Contains quick-germinating turf-type perennial ryegrasses. Touch-Up™ bare spots or overseed your entire lawn with this golf course quality mixture.



Item #	Desc	UPC	Vendor	CS/UOS	Location
81430061	3 lb.	079545121204	12120	15/15	East

Organic Grub & Insect Control

Kills and repels grubs and lawn pests including grubs, fleas, ticks, ants chinch bugs and more. Easy to spread granules. Treats up to 5000 square feet. The active ingredients consist of a proprietary blend of 3 essential plant oils, making it an effective insecticide that is environmentally friendly. It is also safe for use around children and pets when used as directed.



Item #	Desc	UPC	Vendor	CS/UOS	Location
81430240	5M	079545119256	11925	1/1	East



Veri-Green Seeding & Sodding 12-18-8

Green-Up Fertilizer for Seeding & Sodding has been specifically formulated to grow quicker and thicker grassroots which are essential for surviving the stresses of summer and winter. This product also contains humates that enhance the efficiency, availability, and exchange of plant nutrients to and from the soil.



Item #	Desc	UPC	Vendor	CS/UOS	Location
81430237	1.5M	079545160074	16006	12/12	National
81430238	5M	079545160074	16007	1/1	National
81430239	15M	079545160081	16008	1/1	East

Veri-Green Lawn Food 29-0-3

An ideal balance of fertilizer for high-quality turf requirements. Features Green-Meter Technology with 40% slow-release nitrogen that continually feeds the turf for 10 to 12 weeks. Nitrogen release is unaffected by excessive rainfall, thereby reducing grass clippings. Uniform particle size for even distribution. Contains 3% iron and 1% sulfur to help lawns resist drought and disease. Contains humates for root development.



Item #	Desc	UPC	Vendor	CS/UOS	Location
81430235	5M	079545160043	16004	1/1	National
81430236	15M	079545160050	16005	1/1	National

Veri-Green Crabgrass Preventer 20-0-3

A high-quality lawn food that contains a crabgrass preventer to help eliminate crabgrass before it has a chance to grow. Designed to provide a long-lasting green lawn while also controlling the growth of unwanted weeds and crabgrass. Made with slow-release nitrogen that provides a steady supply of nutrients to your lawn over an extended period.



Item #	Desc	UPC	Vendor	CS/UOS	Location
81430231	5M	079545160005	16000	1/1	National
81430232	15M	097545160012	16001	1/1	National

MAG-I-CAL® Plus For Alkaline & Hard Soils

A highly soluble form of calcium that helps to rapidly raise your soil's pH, improving the health of your lawn by releasing trapped nutrients in the soil that feed the grass plants.



Item #	Desc	UPC	Vendor	CS/UOS	Location
81430180	5M	079545122003	11356	1/1	East
81430181	15M	079545122010	11357	1/1	East

MAG-I-CAL® Calcium Fertilizer

A highly soluble form of calcium that helps to rapidly raise your soil's pH, improving the health of your lawn by releasing trapped nutrients in the soil that feed the grass plants.



Item #	Desc	UPC	Vendor	CS/UOS	Location
81430153	5M	079545113537	11353	1/1	East
81430154	15M	079545113520	11352	1/1	East

MAG-I-CAL® Plus For Acidic & Hard Soils

Poor soil is often the problem in growing a great lawn and calcium is vital to many grass plant functions. When soil is compacted or too acidic, air, water, and nutrients are unable to reach the roots, making it very difficult for grass to flourish.



Item #	Desc	UPC	Vendor	CS/UOS	Location
81430178	5M	079545113544	11354	1/1	East
81430179	15M	079545113544	11355	1/1	East

Veri-Green Weed & Feed 21-0-3

Lawn fertilizer and weed killer in one. 3-way action provides superior weed control. Slow release nitrogen fertilizer with polymer-coated technology. Fine particle size for superior weed control feeding action. Greens the lawn in cooler temperatures. Do not apply during hot, dry weather when turf is under stress.



Item #	Desc	UPC	Vendor	CS/UOS	Location
81430233	5M	079545160029	16002	1/1	National
81430234	15M	079545160036	16003	1/1	National



Contractor's Mix Grass Seed

Our cool-season grass seed is ideal for soil stabilization or temporary lawn seeding. It's a great option for quick coverage and erosion control.



Item #	Desc	UPC	Vendor	CS/UOS	Location
81430072	25lb.	079545114589	11460	1/1	East
81430073	50lb.	079545114602	11458	1/1	National

Wildflowers and Meadow Grass Mixture

Contains over 25 wildflowers plus Hard Fescue and Birdsfoot Trefoil to create a pleasant meadow effect. Good for slopes and low maintenance areas that you don't want to mow. One pound covers up to 1,000 sq ft.



Item #	Desc	UPC	Vendor	CS/UOS	Location
81430064	1 lb.	079545123840	12384	18/18	East

White Clover

White Clover Seed is the perfect choice for lawns, gardens and meadows, providing long-lasting coverage for weed control, attractive greenspace, and a rich source of protein for birds, Honey Bees, and beneficial insects. This clover seed is specifically designed to thrive in shade, sun and wet areas, and germinates quickly, offering a lush and vibrant covering. Coverage 1,500 Sq Ft



Item #	Desc	UPC	Vendor	CS/UOS	Location
81430079	1 lb.	079545123819	12381	24/24	East

Season-Long Weed Preventer For Lawn & Landscapes

Crabgrass and weed preventer provides great control of crabgrass and other grassy weeds. contains Dimension (r) for season-long control. does not contain fertilizer. for use on cool and warm season grasses to control or suppress many annual grasses and broadleaf weeds. can be applied up to 4 weeks later than other pre-emergence crabgrass preventers. Labeled for use on over 100 ornamentals.



Item #	Desc	UPC	Vendor	CS/UOS	Location
81430186	5M	079545123604	12360	1/1	East



Vinegar Weed & Grass Killer

Sanco 20% Vinegar Weed & Grass Killer is a quick-acting, non-selective contact herbicide containing an organic acid for which the residues degrade promptly in the soil. Foliar contact results in rapid desiccation and control of annual weeds and grasses, and top growth reduction of herbaceous perennial weeds and grasses. For control of established perennial weeds, retreatment may be necessary. It may be applied up to two days before harvest.



Item #	Desc	UPC	Vendor	CS/UOS	Location
82430061	RTU Quart	810005075794	579	12/12	National
82430060	Gallon	810005075787	578	4/4	National



Milky Spore Spreader Mix

Long-lasting milky spore granular for the yard to control Japanese beetle grubs, naturally killing grubs by eating from inside. Evenly disperse with a spreader across the entire lawn.



Item #	Desc	UPC	Vendor	CS/UOS	Location
80660087	15lb.	699064800154	80015-4	1/1	East

Milky Spore Powder

Kills the grub stage of the Japanese Beetle. Natural bacteria eats the grub from the inside. Safe for use around waterways. Milky Spores don't die, they just multiply and accumulate in the soil lasting for years and the benefits are guaranteed for 10 years. Milky Spore is organic. Just one spore consumed by a grub will multiply into 3 billion new spores when the grub dies.

Apply anytime the ground is not frozen. Not harmful to man, animals or the environment. Does not harm beneficial insects.



Item #	Desc	UPC	Vendor	CS/UOS	Location
80660034	40 oz	699064800406	80040-6	4/4	East

TOOLS & EQUIPMENT



CHECK OUT OUR
CLEARANCE ITEMS!



Griffin Greenhouse Retail WAREHOUSE Shipping Map

We are now shipping nationwide!

2024

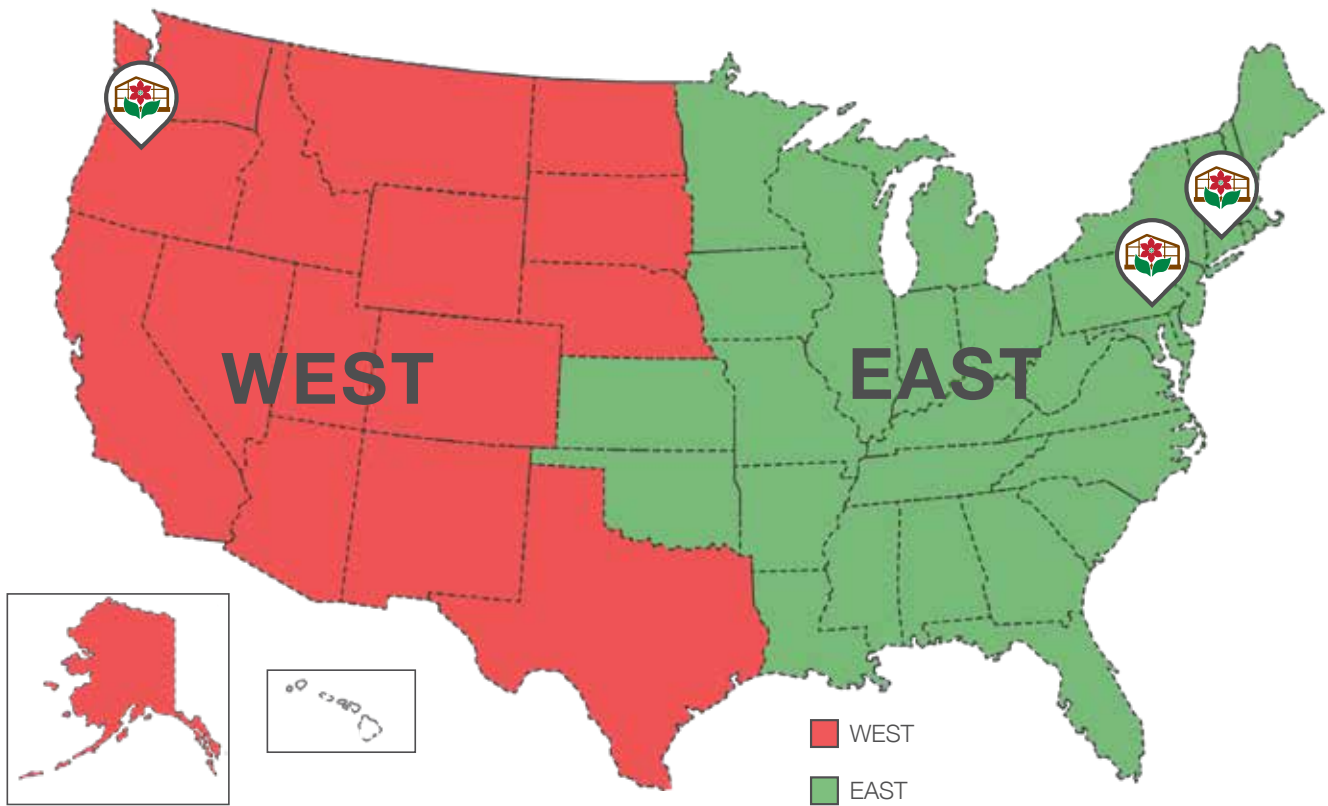

Refer to location key:

National items are stocked nationally
 Select items are sold East or West only; no exceptions

8" Kaleidoscope Planter

Premium plastic modular planter can be displayed individually each planter has a removable saucer ideal for succulents or shallow rooted planted.

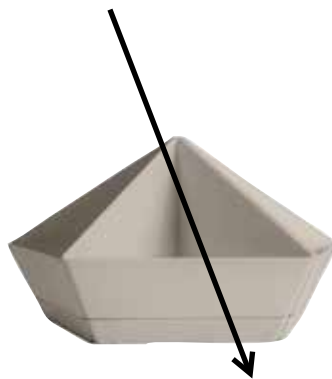

Item #	Desc	UPC	Vendor	CS/UOS	Location
80282643	Vanilla Bisque	770932844170	KDP08000A58	6/6	National

Where is the pricing?

1. Scan QR code on Chapter Pages to see pricing on Griffins.com
2. Contact your Griffin Sales Representative
3. Call into Griffin Customer Service 800.888.0054





Leaf Rake w/ Long Fiberglass Handle

The perfect tool to easily rake large quantities of leaves, grass, and other lawn and yard waste. The 26-32 tines are constructed from a top-grade and lightweight polypropylene that makes it easy and comfortable to use for any job.



Item #	Desc	UPC	Vendor	CS/UOS	Location
82410093	24 tine Rake		LRK002	6/6	National

Flex-Steel Rake w/ Aluminum Handle

To create the healthiest environment for your lawn, your grass and soil need to breathe and receive water. Regular lawn raking will remove thatch and grass clippings that deprive your soil of oxygen and water. This rake is the #1 choice for professional gardeners. 48" Aluminum handle



Item #	Desc	UPC	Vendor	CS/UOS	Location
82410102	8" FlexRake	017849190328	3A	12/12	National
82410100	19" FlexRake	107849190120	1A	12/12	National

Flex-Steel Rake w/ Wood Handle

To create the healthiest environment for your lawn, your grass and soil need to breathe and receive water. Regular lawn raking will remove thatch and grass clippings that deprive your soil of oxygen and water. This rake is the #1 choice for professional gardeners. 48" WOODEN handle



Item #	Desc	UPC	Vendor	CS/UOS	Location
82410101	8" FlexRake Wood	017849190311	3W	12/12	National
82410099	19" FlexRake Wood	017849190113	1W	12/12	National

Hula-Ho Weeder

Quite simply, the heat treated, self-sharpening Hula-Ho blade works beneath the surface of the soil. The almost effortless back and forth "hula" motion cuts weeds at the roots. Meanwhile, the weeds and soil blend to create a healthy mulch.



Item #	Desc	UPC	Vendor	CS/UOS	Location
82410104	Mini Hula-Ho 14" Wooden Handle	017849005004	500W	24/24	National
82410103	Hula-Ho w/54" Wooden Handle	010781104996	1000L	12/12	National

BOSMERE



Tub Trugs

The flex buckets are great for carrying needs like job-site tools, landscaping, catering, yard clean up, laundry basket, livestock feeder, trunk organizer, concrete mixing and much more. 3 of each color per case pack. Colors are red, green, blue, and pistachio.

Item #	Desc	UPC	Vendor	CS/UOS	Location
82010656	3.7 gal	721082074047	G404	12/12	National
82010258	6.8 gal	721082074146	G414	12/12	National
82010657	9.9 gal	721082074245	G424	12/12	National

Hand Leaf Grabs

These Hand Leaf Grabs makes it quick and easy to pick up leaves and other debris from your garden. Strong and durable, these leaf grabs are supplied in a one size fits all and will become a favourite garden tool you'll wonder how you survived without.



Item #	Desc	UPC	Vendor	CS/UOS	Location
82010632	14"	013554144552	N455	10/10	National



Level Head Aluminum Rake (A)

14" Level-head design for efficient, accurate tilling and leveling landscape materials, small head is ideal for working in close quarters. Extra-thick, tempered steel tines for greater strength and long service life. Flat head with straight tines for smooth tamping of seed beds. 60" Aluminum, oval-shaped handle with vinyl coating is lightweight.

Item #	Desc	UPC	Vendor	CS/UOS	Location
81380058	14"	038313640613	RK 64060	3/1	East

Bow Head Wood Handle Rake (B)

Tempered head for greater durability and long service life. Curved tines efficiently gather and move soil. Bow serves as spring for better control of tine depth. 60" Extra-long ash wood handle allows working in upright position, reduces back strain.

Item #	Desc	UPC	Vendor	CS/UOS	Location
81380232	16"	038313200213	RK 20002	3/1	National

Bow Head Fiberglass Rake (C)

Tempered 16-tine head for greater durability and long service life. Curved tines efficiently gather and move soil. Bow serves as spring for better control of tine depth. 60" Extra-long fiberglass handle with cushion grip allows working in upright position, reduces back strain.

Item #	Desc	UPC	Vendor	CS/UOS	Location
81380047	16"	038313200220	RK 20022	3/1	East Coast

Razor Tooth Saw® Folding Saw

For small to medium branches. Up to 3" in diameter razor teeth for efficient cutting. Impulse-hardened teeth for long service life. Replaceable 7" folding blade. Convenient hanging hole.



Item #	Desc	UPC	Vendor	CS/UOS	Location
81380245	Folding Straight Blade	038313004071	RS 7041	6/1	East
81380060	7" Comfort Grip	038313072452	RS 7245	6/6	National

Poly Leaf Rake (D)

24" Poly head allows for medium-capacity leaf raking and general cleanup. 48" wood handle.

Item #	Desc	UPC	Vendor	CS/UOS	Location
81380051	24"	038313250249	RK 25024	12/12	National

Spring Brace Rake (E)

Fan-shaped head combines flexible tines with durability of metal. Stress distribution bar that prevents tines from twisting or breaking when pressed on. Coated frame and tines resist rust. 54" Long wood handle.

Item #	Desc	UPC	Vendor	CS/UOS	Location
81380233	22"	038313240028	RK 24002	12/12	National
81380048	24"	038313240035	RK 24003	12/6	National

Bigload Leaf Rake (F)

The unique head design maximizes load capacity and is both lightweight and durable. Optimized handle length allows for fuller leveraged strokes and more material moved per stroke. Get the leaves raked and move on to your next project with the Corona BigLOAD Leaf Rake.

Item #	Desc	UPC	Vendor	CS/UOS	Location
81380435	26"	038313450267	RK 45026	3/3	National
81380537	30"	038313450304	RK 45030	3/3	East

Landscape Rake Aluminum Handle

All-aluminum construction combines durability with ease of use during finish grading process. Angled, extra-thick tine tips for long service life. 60" in lightweight aluminum handles with non-slip vinyl sleeves for gripping comfort in extreme heat or cold.



Item #	Desc	UPC	Vendor	CS/UOS	Location
81380235	30"Head	038313640637	RK 61063	1/1	National



Classic Cut® Bypass Pruner (A)

Fully forged steel construction for maximum strength, resharpenable blade with non-slip grips for better control. BP 3130 is specifically designed for smaller hands.

Item #	Desc	UPC	Vendor	CS/UOS	Location
81380005	½"	038313000080	BP 3130	6/1	East
81380006	¾"	038313000608	BP 3160	6/6	National
81380007	1"	038313000806	BP 3180D	6/1	National
81386722	1"	038313151805	BP15180	6/6	East

Compound Anvil Hand Pruner (B)

Specially designed to reduce effort and hand fatigue when cutting larger branches, these garden shears feature an innovative four-gear mechanism that increases cutting power with each click, allowing you to adjust for more leverage mid-cut.

Item #	Desc	UPC	Vendor	CS/UOS	Location
81380516	¾"	038313142247	RP 4224D	4/4	National

Forged Pro Cut Bypass Pruner (C)

the high-performance dual Arc blade coating reduces cutting effort by 25% when compared to titanium-coated or non-coated blades.

Item #	Desc	UPC	Vendor	CS/UOS	Location
81380156	1" blades	038313107208	BP 7200	6/6	East

Comfortgel Anvil Pruner (D)

Branch & stem pruner with ComfortGEL® grips for superior comfort and less hand fatigue. Most suitable for cutting hard, dead wood up to ¾ in.

Item #	Desc	UPC	Vendor	CS/UOS	Location
81380647	¾"	038313033347	AP 3334	6/6	East

Flexdial Bypass Pruner (E)

The soft ComfortGEL grips and an integrated ShockGUARD bumper system reduces hand fatigue by absorbing vibration and cushioning each cut.

Item #	Desc	UPC	Vendor	CS/UOS	Location
81380515	¾"	038313142148	BP 4214D	4/4	National

ComfortGEL® Bypass Pruner (F)

ComfortGEL soft, ergonomically shaped grips for maximum comfort, fit and control. Integrated Shock-Guard® bumpers reduce strain and fatigue. Specially coated, non-stick blades helps maintain maximum sharpness. Enhanced cutting performance and lightweight construction. Easy-open lock and accommodates right- and left-handed users.

Item #	Desc	UPC	Vendor	CS/UOS	Location
81380008	¾"	038313032142	BP 3214D	6/6	East

Dual Cut Bypass Pruner (G)

Ideal for pruning green or dry stems and branches up to 1-inch in diameter, these pruning shears feature resharpenable MAXFORGED™ steel blades with two cutting zones. One zone gives you the leverage you need for strong, powerful cuts, while the other offers precision for quick, repetitive cuts.

Item #	Desc	UPC	Vendor	CS/UOS	Location
81380155	1" Forged	038313171001	BP 7100D	6/6	National

Hydroponic Scissor (H)

Stainless steel blades with double beveled tapered tips for precision cuts. Durable handle offers lightweight comfort and performance. Handle and blades can be sterilized to limit cross contamination.

Item #	Desc	UPC	Vendor	CS/UOS	Location
81380030	2" blade	038313041335	FS 4130	12/12	National

Precision Scissor (I)

Precision Scissors are compact and precise cutting tools that are perfect for various gardening and crafting tasks. With sharp stainless steel blades, these scissors offer clean and accurate cuts, whether you're pruning small plants, deadheading flowers, or working on intricate crafting projects.

Item #	Desc	UPC	Vendor	CS/UOS	Location
81380683	Precision Scissor	038313145309	FS 14530	6/6	East



Thinning Shears (A)

Forged steel alloy construction. Scissor cutting action. Suitable for left and right hand use. Resharpenable, straight, narrow blades for tight spaces. Cushioned, non-slip grips.

Item #	Desc	UPC	Vendor	CS/UOS	Location
81380031	1 3/4"	038313002176	FS 4350	6/6	East

Long Straight Micro Snip (B)

Long, straight, pointed blade for a wide range of applications. Fully heat-treated steel 1 3/4" blade for strength. Blades, spring and handle coated to prevent rust. Unobtrusive leather strap lock.

Item #	Desc	UPC	Vendor	CS/UOS	Location
81380103	Steel	038313049300	AG 4930	12/12	National
81380104	Stainless Steel	038313049317	AG 4930SS	12/12	East

Hydroponic Micro Snip (C)

Compact, sharp stainless steel blades with double beveled tapered tips for precision cuts. Durable handle with soft touch feel for lightweight comfort and performance. Heavy-duty spring for reliable performance. Double-sided lock for left or right hand use. Handle and blades can be sterilized to limit cross contamination. 2 5/16" blade.

Item #	Desc	UPC	Vendor	CS/UOS	Location
81380029	Micro Snip	038313041229	FS 4120	12/12	National

Comfortgel Micro Snip (D)

These gardening scissors feature a 1 3/4" double-beveled blade with tapered tips that easily cut leaves, stems and buds in tight areas, making them ideal trimming scissors for herbs, vegetables and more.

Item #	Desc	UPC	Vendor	CS/UOS	Location
81380605	Micro Snip	038313132149	FS 3214D	6/6	National

Clipper Floral Pruning Shear Snip (E)

Maximize comfort and control with soft, ergonomically shaped grips. Fully heat-treated blades maintain sharpness. Volute spring resists dirt build-up and clogging.

Item #	Desc	UPC	Vendor	CS/UOS	Location
81380706	Floral Snip	038313041861	FS43624	12/12	East

Cushioned Grip Polished Aluminum Hand Tools

Lightweight, one-piece, polished aluminum alloy with a cushioned grip. Trowel- Wide 3" blade, Transplanter- Narrow profile ideal for flower pots, Cultivator- 3 Rigid tines penetrate hard ground, Fork- 3 Rigid, straight tines to penetrate ground, Weeder-Ideal for digging or weeding

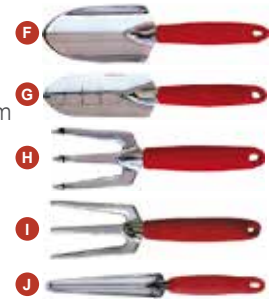

Item #	Desc	UPC	Vendor	CS/UOS	Location
81380014	F Trowel	038313010102	CT 3010i	6/6	National
81380015	G Transplanter	038313010201	CT 3020i	6/6	National
81380016	H Cultivator	038313010300	CT 3030i	6/6	National
81380017	I Fork	038313010409	CT 3040i	6/6	National
81380018	J Weeder	038313210502	CT 3050i	6/6	National

Ergonomic Grip Hand Tools

Cast-aluminum tapered tines move through the soil easily. The most comfortable grip in the garden. Trowel- large capacity with bag ripper, Transplanter- serrated blade for cutting roots and bag ripper feature, Cultivator- 3 rigid tines penetrate hard ground, Cultivator/ hoe-2-in-1 tool for weeding and cultivating, Weeder-serrated blade for cutting roots and bag ripper feature.



Item #	Desc	UPC	Vendor	CS/UOS	Location
81380173	Cultivator	038313037307	CT 3730	6/6	East
81380174	Cultivator/hoe	038313037406	CT 3740	6/6	East

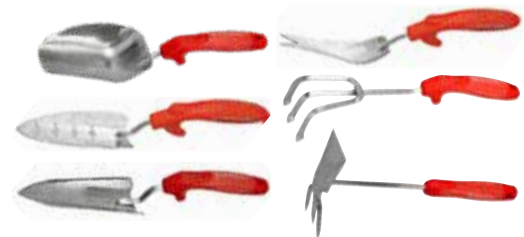

ComfortGel Stainless Steel Tools

Stainless steel heads are durable and will not rust. Ergonomic polygrips minimize hand stress. Safety features include a finger guard and thumb rest, preventing the hand from slipping.

Item #	Desc	UPC	Vendor	CS/UOS	Location
81380524	Scoop	038313336400	CT 3364	8/8	National
81380024	Scoop	038313326401	CT 3264	6/6	East
81380020	Transplanter	038313322403	CT 3224	8/8	East
81380019	Trowel	038313321406	CT 3214	8/8	East
81380669	Trowel 7.25"	038313331405	CT 3314	8/8	National
81380023	Weeder	038313325404	CT 3254	8/8	East
81380523	Weeder	038313335403	CT 3354	8/8	East
81380021	Cultivator	038313323400	CT 3234	8/8	East
81380649	Cultivator	038313333409	CT 3334	8/8	National
81380521	Cultivator	038313332402	CT 3324	8/8	National
81380650	Hoe/Cultivator	038313334406	CT 3344	8/8	National
81380022	Hoe/Cultivator	038313324407	CT 3244	8/8	East



Extendable Handle Hoe (A)

Breaks up clumpy-soil and digs up weeds. Moves and aerates soil.

Item #	Desc	UPC	Vendor	CS/UOS	Location
81380035	18"-34"	038313030605	GT 3060	6/6	National

Extendable Handle Cultivator (B)

Tines cultivate soil during planting process. 7 tine sides to transport, break-up and level soil. Grooved top for fine smoothing of soil.

Item #	Desc	UPC	Vendor	CS/UOS	Location
81380036	18"-34"	038313030704	GT 3070	6/6	National

Extendable Handle Trowel (C)

Strong, lightweight steel handle adjusts from 18" to 32" for extra reach. Head is fully heat-treated for enhanced durability. Long-lasting coating resists chips and rust. Comfortable, soft, textured grip with rugged high-impact thermoplastic ferrule. Convenient hanging ring ensures easy storage.

Item #	Desc	UPC	Vendor	CS/UOS	Location
81380037	18"-34"	038313030803	GT 3080	6/6	National

Extendable Handle Weeder (D)

Item #	Desc	UPC	Vendor	CS/UOS	Location
81380033	18"-34"	038313030407	GT 3040	6/6	East

Extendable Handle Rake (E)

Item #	Desc	UPC	Vendor	CS/UOS	Location
81380034	18"-34"	038313030506	GT 3050	6/6	National

Max Bow Saw

Open frame design allows for increased cut capacity and fewer strokes per cut.



Item #	Desc	UPC	Vendor	CS/UOS	Location
81380672	24"	038313150617	BS15060	6/6	East



Garden Hoe (F)

Swan-shaped neck keeps soil from building up on the tool. 54" Long wood handle allows working in upright position, reduces back strain. Strong socket joint bolstered with a screw. Coated with a clear rust inhibitor.

Item #	Desc	UPC	Vendor	CS/UOS	Location
81380063	6" Blade	038313210007	SH 20000	6/1	National

DHandle 4-Tine Digging Fork (G)

Tempered steel tines for maximum strength and long service life. 29" Wood D handle grip makes it easier to use in tight spaces. 10" Tapered tines for easier soil penetration.

Item #	Desc	UPC	Vendor	CS/UOS	Location
81380026	29"	038313820008	FK 42000	6/6	National

Dutch Hoe with ComfortGEL Grip (H)

This dutch-style Hoe not only helps aerate soil, but slices easily beneath weeds to stop them in their tracks effectively and safely. The lightweight, 63-inch fiberglass handle features a ComfortGEL Grip, helping maintain hand comfort even after hours of work. Give your garden an old-world treatment, without the old-world soreness.

Item #	Desc	UPC	Vendor	CS/UOS	Location
81386754	63"	038313036645	LG 3664	4/4	East

Compound Action Tree Pruner (I)

High-strength zinc alloy pruning head. Fully heat-treated, high-carbon, PTFE non-stick coated cutlery steel blade with 1 1/4" diameter cutting capacity. Durable rope drive, compound-action pulley system triples your cutting power. Exclusive Powerglide™ rope pull system. Curved 13" Razor Tooth Saw®, 3-Sided razor saw teeth cut twice as fast as conventional blades, saving you time and money. Lightweight fiberglass pole telescopes from 6' to 12' with twist lock adjustment. Comfortable 28" grip.

Item #	Desc	UPC	Vendor	CS/UOS	Location
81380301	6'-12'	038313068301	TP 6830	4/4	East
81380078	6'-12'	038313538415	TP 3841	4/4	National



Long-Handle Round Point Shovel (A)

Strong, 15-gauge tempered steel blade. Round point allows easy penetration of a variety of materials. Large, forward-turned steps for firmer footing. 48" Long ash wood handle. #2

Item #	Desc	UPC	Vendor	CS/UOS	Location
81380267	48" wood handle	038313261009	SS 26000	3/3	National
81380291	48"	038313650001	SS 65000	3/3	National

D-Handle Round Point Shovel (B)

Strong, 15-gauge tempered steel blade. Round point allows easy penetration of a variety of materials. Large, forward-turned steps for firmer footing. 30" Ash wood handle with D grip. #2

Item #	Desc	UPC	Vendor	CS/UOS	Location
81380268	30"	038313260019	SS 26010	6/1	National

Long-Handle Fiberglass Round Point Shovel (C)

Strong, 15-gauge tempered steel blade. Round point allows easy penetration of a variety of materials. Large, forward-turned steps for firmer footing. 48" Fiberglass handle with cushion grip for comfort. #2

Item #	Desc	UPC	Vendor	CS/UOS	Location
81380269	48"	038313260200	SS 26020	3/1	National
81380072	48"	038313300203	SS 30020	3/3	East

Hydroponic Finger Snips

The perfect tool for fine, precision cutting a variety of plants. The compact, stainless steel blades stay razor-sharp, while resisting rust and corrosion. The durable ABS plastic handle is lightweight and comfortable, with a large finger loop that adds control when cutting.



Item #	Desc	UPC	Vendor	CS/UOS	Location
81380194	11/4" blade	038313041113	FS 4110	12/12	East

Long-Handle Square Point Shovel (D)

Strong, 15-gauge tempered steel blade. Square-head design for efficient lifting and moving of loose material. Textured epoxy finish protects head. 48" Long ash wood handle. #2

Item #	Desc	UPC	Vendor	CS/UOS	Location
81380069	48"	038313271008	SS 27000	3/3	National

D-Handle Garden Spade (E)

Strong, 14-gauge tempered steel blade. Rounded edge penetrates ground easily, slices through small roots. Textured epoxy finish protects head. 30" Ash wood handle with D grip.

Item #	Desc	UPC	Vendor	CS/UOS	Location
81380278	30"	038313290016	SS 29010	6/1	East

Long-Handle Garden Spade (F)

Strong, 14-gauge tempered steel blade. Rounded edge penetrates ground easily, slices through small roots. Textured epoxy finish protects head. 48" Long ash wood handle.

Item #	Desc	UPC	Vendor	CS/UOS	Location
81380277	48"	038313290009	SS 29000	6/1	East

Edgemaster With Comfortgel Grip

EdgeMASTER Edging Tool delivers quick, clean cuts in grass, sod or soil. Use it to trim sidewalks and create borders for gardens or flower beds. The high-carbon steel ribbed blade is fully heat-treated, durable and self-sharpening. The double-traction grooved footplate supports additional load-bearing pressure. ComfortGEL handles feel great while working.



Item #	Desc	UPC	Vendor	CS/UOS	Location
81380532	Edger	038313368418	LG 3684	4/4	National



ComfortGEL Grip QuickCOLLECTOR (A)

When seed pods and tree nuts fall onto the landscape, they can make quite a mess. Especially when they fall onto mulched or grassy areas where they are tricky to rake or sweep up. QuickCOLLECTOR™ makes clean up easier with less effort.

Item #	Desc	UPC	Vendor	CS/UOS	Location
81380533	48"	038313036942	LG 3694	4/4	National

ComfortGEL Grip Weed Destroyer (B)

Removes tough weeds, without the use of chemicals. All steel footplate, with slip-resistant traction groves, for added control. Fully heat-treated, high carbon steel blades, for extra strength when driving into the soil.

Item #	Desc	UPC	Vendor	CS/UOS	Location
81380531	14.25"	038313365417	LG 3654	4/4	National

ComfortGEL Grip DiscCULTIVATOR (C)

Quick work of maintaining the topsoil around ornamental and crop plants, weeding between rows, aerating soil and prepping bare spots in lawns for reseeding. Its 3 sets of steel tines will do the hard work for you and can be configured to work up close to plants without damaging them or soil structure.

Item #	Desc	UPC	Vendor	CS/UOS	Location
81380530	48"	038313036348	LG 3634	4/4	National

ComfortGEL Grip Soil RIPPER (D)

Used for turning and aerating soil and the development of seed-rows in gardens. A substitute for rototillers in small developed gardens or raised-bed gardens.

Item #	Desc	UPC	Vendor	CS/UOS	Location
81380529	9"x6" steel tines	038313362416	LG 3624	4/4	National

Hori Hori Garden Knife

Flanged at base to protect hand from slipping onto blade. Serrated multi-purpose steel blade for digging, cutting & transplanting.



Item #	Desc	UPC	Vendor	CS/UOS	Location
81386724	8"	038313154097	CT15409	8/8	National



ComfortGEL® Bypass Lopper (E)

ComfortGEL® soft, ergonomically shaped grips for maximum comfort, fit and control. Integrated Shock-Guard® bumpers reduces strain and fatigue. Specially coated, non-stick blades helps maintain maximum sharpness. Enhanced cutting performance with Dual Arc blade design with a 1 1/2" cutting capacity. 30" extra strength, trapezoidal steel handles.

Item #	Desc	UPC	Vendor	CS/UOS	Location
81380064	30"	038313032647	SL 3264	6/6	East

Compound Action Anvil Lopper (F)

Compound Action Anvil Lopper with 1 1/2" cut capacity. 4-Bar compound linkage triples your cutting power. Resharpenable, PTFE non-stick coated high-carbon steel anvil blade. 24" Fiberglass handles. Replaceable blade and anvil. Extra-long 8" non-slip foam grips.

Item #	Desc	UPC	Vendor	CS/UOS	Location
81380027	24"	038313044381	FL 3420	6/1	East

Hedge Shear (G)

Resharpenable, forged 8 1/4" steel alloy blades. Top-grade 9 1/2" hardwood handles. Fully heat-treated for strength. Limb notch for larger branches. Comfortable non-slip grips.

Item #	Desc	UPC	Vendor	CS/UOS	Location
81380199	8 1/4"	038313839116	HS 3911	6/6	East

Comfortgel Hedge Shear (H)

The ComfortGEL Hedge Shear with 8 in. blades are designed to make quick work of trimming hedges and bushes. The soft, ergonomically shaped grips maximize comfort and control. The Shock GUARD bumpers reduce hand and shoulder fatigue, making gardening activities a joy rather than a chore.

Item #	Desc	UPC	Vendor	CS/UOS	Location
81380039	9"	038313032449	HS 3244	6/6	East

Push. Pull. Lift. Dump.

6 Cube Wheelbarrow



6CF Steel Wheelbarrow with sealed wood handles, and pneumatic tire

6CF Steel Wheelbarrow with steel handles and comfort grips. Features a flat free tire.

Item #	Desc	Vendor	CS/UOS	Location
81386888	A 6.0 CF, Wood handles, Pneumatic tire	WB13060	1/1	National
81386889	B 6.0 CF, Steel Handles, Flat free tire	WB13163	1/1	National

Kids Wheelbarrow

Kids Poly Wheelbarrow Red Perfect for kids to outdoor yard work.



Item #	Desc	UPC	Vendor	CS/UOS	Location
81380709	Kids Wheelbarrow	038313110024	KD 1002	4/4	East

Kids Garden Tool Set

Kids can work right along side their Parents and experience the thrills of gardening 3pc tools set Shovel, Rake, Hoe in Red



Item #	Desc	UPC	Vendor	CS/UOS	Location
81380708	3 Piece	038313913014	KD 1001	18/18	National

Poly Wheelbarrow

Corrosion-proof, poly tray with UV protection. Reinforced steel-front tray braces for added support and stability. 15" Wheel assembly with knobby, 4-ply tire for easy maneuvering. Ball bearings for years of smooth performance.



Item #	Desc	UPC	Vendor	CS/UOS	Location
81380079	15" 6cf	038313010065	WB 1006	1/1	West

Floral Scissors

Ergonomic grips for superior comfort. Wavy serrated edges to hold stems while cutting, resharpen able stainless steel blades.



Item #	Desc	UPC	Vendor	CS/UOS	Location
81380652	3" blade	038313033941	FS 3394	6/6	National

ClassicCUT Grass Shear

Cuts tough sod and ground cover. Helps you grip the scissors even with sweaty hands and scissors stay comfortable to hold cut after cut. Ideal shear for trimming grass, ground cover, and small hedges.



Item #	Desc	UPC	Vendor	CS/UOS	Location
81380197	4"	038313000059	GS 6750D	6/6	National

Sharpening Tool

5" Super carbide file. Ideal for sharpening all straight blades (excludes saw blades). Easy to fit in pocket or scabbard. Non-slip grip for easy use.



Item #	Desc	UPC	Vendor	CS/UOS	Location
81380003	5"	038313083007	AC 8300	12/12	National

Leather Scabbard

Top-grain leather construction. Stitched and riveted for durability. Belt clip and loops included. Universal design fits most hand pruners.



Item #	Desc	UPC	Vendor	CS/UOS	Location
81380001	5"	038313000813	AC 7220	6/6	National

Nylon Scabbard

Durable Cordura nylon construction. Universal design fits hand pruners and folding saws. Easy to carry using metal clip or belt loops.



Item #	Desc	UPC	Vendor	CS/UOS	Location
81386675	6.75lin L	038313045104	AC 4510	1/1	West



Cultivator with Wood Handle (A)

The optimal choice for weeding and cultivating in one stroke, this Corona® 4 Prong Cultivator has a 54" long wooden handle.

Item #	Desc	UPC	Vendor	CS/UOS	Location
81380025	54"	038313200046	CV 20004	6/6	West

Manure Fork (B)

Forged, tempered head for maximum strength and long service life. Medium- to heavy-duty fork for moving manure, compost, planting mix and other dense, damp material.

Item #	Desc	UPC	Vendor	CS/UOS	Location
81380186	5 Tine	038313720056	FK 72005	6/6	West

Max Two Bristle Push Broom (C)

Scraper blade for removing congealed dirt, gum and other residues from concrete walks and pavers. Head is bolted to cast-metal socket, which is pinned to handle, cannot twist loose like threaded handle.

Item #	Desc	UPC	Vendor	CS/UOS	Location
81380139	24" head	038313610029	BM 61002	1/1	West

One Bristle Push Broom (D)

Replaceable hardwood head with medium, feathered poly bristles removes both coarse and fine material in one pass. Head is bolted to cast-metal socket, which is pinned to handle, cannot twist loose like threaded handle.

Item #	Desc	UPC	Vendor	CS/UOS	Location
81380141	24" head	038313620622	BM 62060	1/1	West



Cultivator with Wood Handle

Tempered steel tines for maximum strength and long service life. 29" Wood D handle grip makes it easier to use in tight spaces. 10" Tapered tines for easier soil penetration.

Item #	Desc	UPC	Vendor	CS/UOS	Location
81386790	29"	038313170004	FK 70000	6/6	West



ComfortGEL® Hoe / Cultivator (E)

ComfortGEL® Garden Tools are designed for gardeners working on raised-bed gardens, small gardens and tight access locations. Optimal length for long reach and balance and ideal for gardeners who have physical strength limitations that make large tools hard to manage. The unique, trapezoid shaped handles add comfort and control. ComfortGEL® grips deliver comfort to gardeners who seek an easier, more therapeutic gardening experience.

Item #	Desc	UPC	Vendor	CS/UOS	Location
81380654	36"	038313324414	GT 3244	4/4	West

YardBREATHER w/ ComfortGEL Grip (F)

The Corona YardBREATHER™ allows you to easily break up grass and compact soil to allow air, water and nutrients to reach the roots to promote growth. Designed to automatically eject three, 50inch long soil plugs with each step. The slip resistant, traction grooves on the footplate add safety and stability while the heat treated steel footplate and spikes gives lasting durability. With ComfortGEL grips deliver comfort and control when working the garden and yard.

Item #	Desc	UPC	Vendor	CS/UOS	Location
81380528	50"	038313360412	LG 3604	4/4	West

RootIRRIGATOR w/ ComfortGEL Grip (G)

ComfortGEL lawn and garden tools were made for exceptional comfort and control. We've engineered and developed this range of tools to provide you with hand-held solutions to cultivate, weed, till and maintain your property. Repair your lawn, edge a border or prepare a garden bed with comfort and innovative features.

Item #	Desc	UPC	Vendor	CS/UOS	Location
81380534	36.5"	038313371012	LG 3710	4/4	West

Operating Wrench (H)

Multifunctional, opens valves with 3 interchangeable heads - 1, 1/8 and 2 inches. Square key operates gate valves with a 2 inch square operating nut. Conveniently store heads on tool with snap button lock. Extends from 3 to 5 feet by releasing a snap button. Solid steel construction with "T" style handle design for better leverage. Red color so it's easier to find on the job.

Item #	Desc	UPC	Vendor	CS/UOS	Location
81386869	3-in-1	038313699994	UT 69000	2/2	West



Light-Duty Bow Head Rake (A)

Tempered, single-piece head for greater durability and long service life. Curved tines efficiently gather and move soil. Bow serves as spring for better control of tine depth.

Item #	Desc	UPC	Vendor	CS/UOS	Location
81380044	14" head	038313810009	RK 10000	6/6	West

Thatch & Groom Rake (B)

Industry standard thatching rake works on push and pull motions. Unique, adjustable rake head adjusts up and down to suit the height of the user. Quickly and easily rid heavy layers of thatch and dead grass from any lawn.

Item #	Desc	UPC	Vendor	CS/UOS	Location
81380053	15" head	038313520007	RK 42000	6/6	West

BigLOAD JR Leaf Rake (C)

Rake up to 2x faster than standard leaf rakes. Unique head design maximizes load capacity. 26 in. wide poly head is both lightweight and durable. 63 in. aluminum handle with anti-slip vinyl grip for gripping comfort in extreme heat or cold.

Item #	Desc	UPC	Vendor	CS/UOS	Location
81380520	26"	038313450267	RK 45026	8/8	West

Fixed Tine Shrub Rake w/ Wood Handle (D)

This shrub rake has tempered spring steel for greater durability and long service life, with a Bi-curved bow that gives even pressure to 11 tines for maximum raking efficiency. Narrow head allows for raking between bushes and closely spaced plants.

Item #	Desc	UPC	Vendor	CS/UOS	Location
81380236	11" head	038313562007	RK 62000	12/12	West

Fixed Tine Shrub Rake (E)

This Corona Fixed Tine Rake is ideal for raking in tight spaces such as around shrubs and other plantings

Item #	Desc	UPC	Vendor	CS/UOS	Location
81380056	11" head	038313620608	RK 62060	12/12	West

Fixed Tine Leaf Rake (F)

Fixed tine shrub and leaf rake with 25 extra-wide tines; applies light pressure without damaging plant feeder roots. Bi-curved bow design gives even pressure to all tines for maximum raking efficiency. Rake head made from tempered spring steel for greater durability.

Item #	Desc	UPC	Vendor	CS/UOS	Location
81380057	19" wide	038313620615	RK 62061	12/12	West

Level Head Rake (G)

14 inch level-head design for efficient, accurate tilling and leveling landscape materials, small head is ideal for working in close quarters. Extra-thick, tempered steel tines for greater strength and long service life. Flat head with straight tines for smooth tamping of seed beds.

Item #	Desc	UPC	Vendor	CS/UOS	Location
81380238	16" head	038313700027	RK 64002	3/3	West



Closed-Back Drain Spade

Closed-Back Design Protects Handle From Mud And Dirt Build Up. Baked Finish Protects Against Rust. Double Rivets Give Greater Strength. Tempered, Round-Nose, Slightly Cupped, 16" Blade For Efficient Digging Of Deep, Round-Bottom Drains And Trenches.

Item #	Desc	UPC	Vendor	CS/UOS	Location
81386817	16"	038313620103	SS 62010	6/6	West



Trench Shovel

Efficient Digging 28 Degree Design Engineered To Penetrate & Loosen Compacted Soil. Heavy duty 12 gauge V-Shaped Beveled Blade. Sole Saver Step with rounded corners reduces boot wear.

Item #	Desc	UPC	Vendor	CS/UOS	Location
81386830	3" - Blue	038313643034	SS 64303	6/6	West
81386831	4" - Orange	038313543044	SS 64304	6/6	West



Compound Action Hedge Shears (A)

Compound Action Aluminum Handle Hedge Shear 8 1/2" high-carbon steel blades are fully heat treated Compound action multiplies your cutting power Top blade is serrated and features a limb cutting notch Bottom blade is Teflon(tm) coated for easy clean cutting Lightweight, strong aluminum handles with ergonomic grip.

Item #	Desc	UPC	Vendor	CS/UOS	Location
81380108	9"	038313042202	AH 4220	6/6	West

Extendable Hedge Shears (B)

Extendable handle hedge shears with ComfortGEL grips for superior comfort and less hand fatigue.

Item #	Desc	UPC	Vendor	CS/UOS	Location
81380656	9"	038313033446	HS 3344	6/6	West

Bypass Lopper (C)

Corona's 26-inch bypass lopper has tapered hickory handles and blister-deterring nonslip grips. Its resharpenable, dropforged, Radial Arc bypass, Coronium steel alloy blade has a 1-1/2-inch-diameter cutting capacity. The lopper also boasts a precision slant-ground hook with sap groove for consistently smooth cutting.

Item #	Desc	UPC	Vendor	CS/UOS	Location
81380319	26"	038313005269	WL 3351	6/6	West

Super-Duty Bypass Lopper (D)

Corona SL 6500 Super Duty Bypass 32 inch Lopper has a 3" cut capacity to power through large branches. Comprised of forged blades at a cutting angle designed to cut 3" branches and robust steel handles to handle extreme leverage, the SL 6500 can expeditiously cut through thick branches.

Item #	Desc	UPC	Vendor	CS/UOS	Location
81380262	32"	038313665005	SL 6500	6/6	West

Easy Cut Bypass Lopper (E)

EasyCUT COMPOUND ACTION magnifies your cutting power so you can do more with less effort.

Item #	Desc	UPC	Vendor	CS/UOS	Location
81380190	32"	038313044367	FL 3460	6/6	West

ComfortGEL Extendable Bypass Loppers (F)

Reach new heights (and lengths) with Corona Tools strength with the Dual LINK Extendable Bypass Lopper with Comfort GEL grip. Dual LINK power-compounding technology makes tree pruning effortless for gardeners and landscapers alike.

Item #	Desc	UPC	Vendor	CS/UOS	Location
81380660	27.5"-37.5"	038313033644	SL 3364	6/6	West

Dual Cut Bypass Lopper (G)

Take care of your garden with this Corona DualCUT bypass lopper. The special hook design allows sharp branch cutting. Max forged steel construction ensures long-lasting sharpness. Made for most hand sizes, it offers comfortable, contoured handle grips and a shock-absorbing bumper.

Item #	Desc	UPC	Vendor	CS/UOS	Location
81380066	31"	038313071806	SL 7180	6/6	West

Two-Handed Pruner

Corona's forging process compacts steel molecules into our strongest, most durable tools that stay sharper longer. Two-handed pruner is ideal for landscaping pros and avid gardeners



Item #	Desc	UPC	Vendor	CS/UOS	Location
81380144	3/4"	038313632250	BP 3225D	6/6	West



Landscape Irrigation Bypass Pruner (A)

Forged high carbon steel forms a stronger, more durable cutting tool. Ergonomic angled pruning head for added comfort and reduced hand stress.

Item #	Desc	UPC	Vendor	CS/UOS	Location
81380146	1"	038313136703	BP 3670	6/6	West

Ergonomic Bypass Pruner (B)

Ergonomic Bypass Pruner is the perfect gardening hand tool for taking on your everyday gardening and landscaping work. These lightweight pruning shears feature an angled bypass blade for cutting low-lying green or dry branches and stems up to 5/8-inch thick.

Item #	Desc	UPC	Vendor	CS/UOS	Location
81380147	2.5"	038313041809	BP 4180	6/6	West

Flexdial Bypass Pruner (C)

Cut green or dry branches and stems up to 3/4-inches in diameter with the Corona FlexDIAL Bypass Pruner. This flexible bypass pruner features an adjustable 8-position dial that is designed to easily adapt to your hand size and the way you landscape or garden.

Item #	Desc	UPC	Vendor	CS/UOS	Location
81380573	2.75"	038313142148	BP 4214D	4/4	West

Forged Bypass Pruner Rolling Handle (D)

The ergonomic "rolling" handle design of this pruner helps to reduce both cutting effort and user fatigue. A geared pivot bolt allows for precise blade adjustments. The volute spring resists clogging and maintains smooth cutting action. High-carbon steel blade. Lightweight forged aluminum handles.

Item #	Desc	UPC	Vendor	CS/UOS	Location
81380148	1"	038313048402	BP 4840	6/6	West

DualCUT Branch & Stem Pruner (E)

This precision made MaxForged branch & stem pruner uses a forging process that compacts steel molecules into one of Corona's strongest, most durable garden cutting tools while the patented dual cut blade & notched hook designs provide both a power zone & precision zone of cutting.

Item #	Desc	UPC	Vendor	CS/UOS	Location
81380668	1"	038313171001	BP 7100D	6/6	West

Ratchet Cut Pruner

Specially designed to reduce effort and hand fatigue when cutting larger branches, these garden shears feature an innovative four-gear mechanism that increases cutting power with each click, allowing you to adjust for more leverage mid-cut.



Item #	Desc	UPC	Vendor	CS/UOS	Location
81380575	3"	038313142247	RP 4224D	4/4	West

Pipe Cutter

High-Carbon Dteel Blade for Maximum Performance; Flip-up Tab on Bolt - No Tools Needed to Change the Blade Quickly; Crosshatch Grip on Blade for Easy Replacement; Use Left or Right Hand to cut pipe with Ease.



Item #	Desc	UPC	Vendor	CS/UOS	Location
81380438	1" PVC	038313165505	UT 65050	6/6	West

Steel Sledge Hammer

Solid core fiberglass handle. Forged, tempered steel heads break through concrete, asphalt, masonry, drywall or virtually any material. Minimize deflections and finish your work faster with dual ground and polished convex striking faces.



Item #	Desc	UPC	Vendor	CS/UOS	Location
81380298	4lb	038313170028	ST 70020	4/4	West

Sledgehammer

34" Solid Core Fiberglass handle. Forged, tempered steel heads break through concrete, asphalt, masonry, drywall or virtually any material. Minimize deflections and finish your work faster with dual ground and polished convex striking faces.



Item #	Desc	UPC	Vendor	CS/UOS	Location
81386847	12lb	038313701246	ST 70024	4/4	West

ErgoHandle Machete

Durable blade, tough tempered Steel for greater strength retains max sharpness. Easy to re-sharpen, carbon Steel blade. Ergonomically comfortable handle balanced with blade length.



Item #	Desc	UPC	Vendor	CS/UOS	Location
81380657	22"	038313600129	MA 60062	6/6	West



Pick Mattock w/ Wood Handle

Forged, tempered steel head hardened for maximum strength, toughness, superior wear, impact resistance, safety and long service life. Extra-wide mattock blade for more efficient breaking of dense heavy soils. Point for fracturing, prying rock. Head connected through eye hole allowing easy replacement of head.



Item #	Desc	UPC	Vendor	CS/UOS	Location
81380220	5lb 36"	038313411008	PM 41000	4/4	West

Cutter Mattock w/ Wood Handle

Extra-wide mattock blade for more efficient breaking of dense heavy soils. Extra-sharp cutter blade for severing roots. Head connected through eye hole allowing easy replacement of head.



Item #	Desc	UPC	Vendor	CS/UOS	Location
81380221	5lb 36"	038313420000	PM 42000	4/4	West

Planting Mattock

All-steel construction for rugged use and long life. High-quality, welded construction for superior strength. Rubber grips on handles for comfortable anti-slip grip.



Item #	Desc	UPC	Vendor	CS/UOS	Location
81386794	2" wide blade	038313692001	HT 69200	6/6	West

Pulaski Fire Axe

Solid-core fiberglass handle with thick, molded poly jacket for maximum strength and long service life. Dampens vibration from overstrikes to prevent breakage. Extra-sharp axe blade with steep bevel angle to hold edge while cutting roots in soil.



Item #	Desc	UPC	Vendor	CS/UOS	Location
81380137	3lb head	038313071028	AX 71020	4/4	West

Folding Curved Blade Pruning Saw

The 10-1/2" Folding Pruning Saw is designed to be as comfortable in your hand as it is effective in the field. This self-cleaning raker tooth model resists binding on green or woody limbs. Designed for small to medium branches, the 10-1/2-inch blade folds into the handle for safety, storage, and easy transport.



Item #	Desc	UPC	Vendor	CS/UOS	Location
81380228	10"	038313000417	PS 4050	6/6	West

Extendable Fruit Picker

Hook the fruit between the prongs and gently pull to pick. 5 in. D basket is powder-coated to resist rust and corrosion. Foam cushion in basket reduces fruit bruising. Aluminum pole extends to 12 ft.



Item #	Desc	UPC	Vendor	CS/UOS	Location
81380028	12ft	038313723125	FP 2312	6/6	West

Forged Digging Bar

Drop-forged and heat-treated for excellent strength during prying, digging and tamping. Hexagon steel construction for enhanced strength. 1" blade width.



Item #	Desc	UPC	Vendor	CS/UOS	Location
81380158	17lb 70"	038313710903	BR 71090	1/1	West

San Angelo Bar

Drop-forged and heat-treated for excellent strength during prying, digging and tamping. Hexagon steel construction for enhanced strength. 1" blade width.



Item #	Desc	UPC	Vendor	CS/UOS	Location
81380013	14lb 60"	038313700904	BR 70090	1/1	West

Long Reach Pruner

Ideal for pruning high or low, without bending or straining. Head rotates, tilts, and swivels for unlimited cutting positions. Oval end-grip with rubber overmold increases reach.



Item #	Desc	UPC	Vendor	CS/UOS	Location
81380299	1.25" in cut	038313032067	TP 3206	4/4	West

Long Reach Cut 'n' Hold Pruner

Light duty extendable pruner designed to cut small twigs and collect them inside hard to reach areas. Cuts up to 1/2 inch diameter. Assists in preventing falling limbs and allows you to cut safely.



Item #	Desc	UPC	Vendor	CS/UOS	Location
81380205	46"	038313634605	LR 3460	6/6	West



Post Hole Digger (A)

Heavy-duty, 14-gauge tempered steel heads for greater strength and long service life. Pre sharpened-blade edge for easy ground penetration, slices through small roots. 48" Extra-thick ash handles for durability, longer service life and more elevated grip.

Item #	Desc	UPC	Vendor	CS/UOS	Location
81380042	48"	038313200015	PD 20000	2/2	West

Oscillating Hoe (B)

Heavy-duty construction blade design for long service life. Hoe automatically angles slightly downward on both forward and back stroke to slice weeds just below surface.

Item #	Desc	UPC	Vendor	CS/UOS	Location
81380256	5"	038313160012	SH 60001	6/6	West

Diamond Hoe (C)

Diamond shape head with four sharpened edges cuts weeds on both forward and back strokes. Points of diamond shaped blade can nick even small weeds from hard to reach areas.

Item #	Desc	UPC	Vendor	CS/UOS	Location
81380257	8"	038313061005	SH 61000	6/6	West

McLeod Hoe (D)

Tempered tines for maximum strength and long service life. The 48"L American Ash wood handle enables upright stance, reducing back strain. Hoe edge is 9" wide with six 3-3/5-inch long rake teeth. Ships unassembled.

Item #	Desc	UPC	Vendor	CS/UOS	Location
81386810	48" long	038313065003	SH 65000	6/6	West

Dirt Tamp (E)

Heavy-duty, all-steel cast construction for long service life. 10" Square face and 60" long shaft for efficient tamping of trenches, specimen tree holes and base materials

Item #	Desc	UPC	Vendor	CS/UOS	Location
81386854	10" X 10"	038313600532	UT 60053	1/1	West

Light-Duty Floral Shovel (F)

Small head design for easier use in gardens and tight spaces. 6 inch x 8 inch steel Head.

Item #	Desc	UPC	Vendor	CS/UOS	Location
81380283	42"	038313970000	SS 47000	6/6	West

Square Point Shovel (G)

Square-head design for efficient lifting and moving of loose material. Large, forward-turned steps prevent material from spilling off rear of blade. Extra-thick, 14-gauge tempered steel blade for maximum toughness.

Item #	Desc	UPC	Vendor	CS/UOS	Location
81380294	48"	038313660000	SS 66000	3/3	West

Round Point Shovel w/ Fiberglass Handle (H)

Extra-thick, 14-gauge tempered steel blade for maximum toughness. Extended widow's peak socket adds strength for a secure connection. Baked finish protects against rust. Pre-sharpened blade edge penetrates ground easily.

Item #	Desc	UPC	Vendor	CS/UOS	Location
81380293	48"	038313650209	SS 65020	6/6	West



Aluminum Scoop Shovel

30" Steel and Northern Ash wood, D grip helps turn loosened soil, easier to use in close quarters. High-strength, heavy, 12-gauge aluminum head reduces work load to a minimum while giving longer service life.

Item #	Desc	UPC	Vendor	CS/UOS	Location
81380296	30"	038313680107	SS 68010	4/4	West



Bypass Pruner Carded

The Bypass Pruner with stainless steel blades is designed for garden and yard trimming. With non-slip rubber grips molded over a cast aluminum frame, the Bypass Pruner offers both strength and comfort. The Bypass Pruner has a 5/8-Inch cutting capacity and a locking mechanism for safe storage. Available six bright colors. Case pack features six assorted colors

Item #	Desc	UPC	Vendor	CS/UOS	Location
80170066	Pruner	10036434180404	10-18040	12/12	National



Compact Shears

The Compact Shear is ideal for cutting flowers, or multiple household uses. The lightweight shear is made with corrosion resistant stainless steel blades for precise trimming and shaping, and is great for Bonsai. The ergonomic handle fits your hand for a comfortable cut every time. The Compact Shear has a blade lock mechanism for safe storage. Case includes 2 each pruners of 6 vivid colors

Item #	Desc	UPC	Vendor	CS/UOS	Location
80170062	Shear	036434180209	10-18020	12/12	National



Compact Pruners

The Compact Pruner is the perfect tool for trimming woody stems and perennials. The lightweight pruner is made with corrosion resistant stainless steel blades and 1/4-Inch cutting capacity. The ergonomic handle fits your hand for a comfortable cut every time. The ColorPoint Compact Pruner has a blade lock mechanism for safe storage and is available in six brilliant colors.

Item #	Desc	UPC	Vendor	CS/UOS	Location
80170061	Pruner	10036434180107	10-18010	12/12	National



A



B



C



D

Compact Display Boxes

Item #	Desc	UPC	Vendor	CS/UOS	Location
80170473	Berry Shears	036434180261	6019010	6/6	West
80170472	Blue Shears	036434180254	6018026	6/6	West
80170471	Green Shears	036434180247	6018025	6/6	West
80170470	Yellow Shears	036434180230	6018024	6/6	West
80170469	Orange Shears	036434180223	6018023	6/6	West
80170468	Red Shears	036434180216	6018022	6/6	West
80170063	A Shears Asst.	036434280203	10-28020	12/12	National
80170467	Berry Pruners	036434180162	6018021	6/6	West
80170466	Blue Pruners	036434180155	6018016	6/6	West
80170465	Green Pruners	036434180148	6018015	6/6	West
80170464	Yellow Pruners	036434180131	6018014	6/6	West
80170463	Orange Pruners	036434180124	6018013	6/6	West
80170462	Red Pruners	036434180117	6018012	6/6	West
80170064	B Pruners Asst.	036434280104	10-28010	12/12	National
80170065	C Shear/Pruner combo Asst.	036434280197	10-28019	12/12	National
80170251	D Bypass Pro Asst.	10036434280906	1028090	12/12	National





Poly Tarp

These are UV resistant and have heat sealed seams. Aluminum rustproof grommets about every 3' around the hem. 3/16" bolting in hem. 5-6 mil thickness. 2.3 oz.



Item #	Desc	UPC	Vendor	CS/UOS	Location
80010106	6'x 8'	043326157102	M6X8	30/30	National
80010107	8'x 10	043326157201	M8X10	20/20	National
80010108	10'x 12'	043326157324	M10X12	15/15	National
80010110	12'x 16'	043326157454	M12X16	8/8	National
80010117	20'x 20'	043326157614	M20X20	4/4	National



Brown/Green Reversible Tarp

These tarps have rope reinforced hems, oxidation-resistant aluminum grommets on corners and approximately every 36", heat-sealed seams and hems and are a full finished size (+/-3%). Available in a variety of sizes in brown/green reversible colors.



Item #	Desc	UPC	Vendor	CS/UOS	Location
82300021	6' x 8'	749856100686	10068	40/40	East
82300022	8' x 10'	749856108101	10810	25/25	East
82300025	10' x 12'	749856110128	11012	20/20	East
82300032	16' x 20'	749856116205	11620	6/6	East

2024



4 gal Heavy Duty Piston Backpack Sprayer

- HDPE* translucent tank
- High-efficiency poly pumps
- Includes padded shoulder harness with waist attachment for comfort
- Seals: FPM • Hose: 3/8" I.D.
- Chemicals to avoid: Diesel, Gasoline, Acid, Oil base stains, Bleach



Item #	Desc	UPC	Vendor	CS/UOS	Location
81880009	4gal	026156913438	614PR	1/1	East



F-600 Folding Miracle Saw

Fast, easy pull action is easier and safer than other saws. The shape of the turbo-cut blade is thinner at the top and thicker at the bottom-where the teeth are. This unique Felco feature keeps only the teeth in contact with the material to be cut. This prevents clogging and binding, since the sides of the blade never come in contact with the wood.



Item #	Desc	UPC	Vendor	CS/UOS	Location
80260012	Saw	783929100265	11600	40/1	East

4 gal Heavy Duty Diaphragm Backpack Sprayer

- High-density polyethylene tank
- Designed for professional applications
- Flow control with lock-on and positive lock-off
- Seals: FPM • Hose: 3/8" I.D.



Item #	Desc	UPC	Vendor	CS/UOS	Location
81880008	4gal	026156913353	914PR	1/1	East

Victorinox Knife Pointed Blade

The Felco and Victorinox folding all purpose budding knife with a durable stainless steel blade and bark lifter and alloyed lined red nylon handle. Ideal for nurseries and gardeners to encourage bud production. This Swiss made horticultural budding knife is a must for any garden.



Item #	Desc	UPC	Vendor	CS/UOS	Location
83-1440	Knife	7611160003140	61882R	1/1	East



Heavy-Duty Flat Belt/Clip Pruner Holster

For belt or pocket, high-tension metal clip on back. Holds any Felco pruner, Felco onehand wire cutters, the F-CP cutter or the F600 pruning saw.



Item #	Desc	UPC	Vendor	CS/UOS	Location
80260016	9.3"	783929400679	13910	1/1	East

Cone-Shaped Belt/Clip Pruner Holster

Heavy-duty grain leather with, waxed thread and extra riveting for long lasting use. This holster was specially designed to fit all Felco pruners and one-hand wire cutters. Can be used on belt or pocket with clip.



Item #	Desc	UPC	Vendor	CS/UOS	Location
80260017	5.9"	783929400686	13912	1/1	East



F-2 Hand Pruner (A)

Comfortable, light, sturdy handles made of forged aluminium with a lifetime guarantee. Blade and riveted anvil blade made of high quality hardened steel. Clean, precise cut. All parts can be replaced.

Item #	Desc	UPC	Vendor	CS/UOS	Location
80260008	Pruner	783929100012	112	50/1	East

F-5 Economy Pruner (B)

The Felco 5 bypass pruner, with handles made from solid steel and simplified construction, is an ideal choice for the home hobby gardener. No cushion stop, sap groove or wire-cutting notch.

Item #	Desc	UPC	Vendor	CS/UOS	Location
80260010	Pruner	783929100036	115	50/1	East

F-8 Pruner (C)

Both cutting and anvil blades are not riveted and the narrow, pointed blade design allows for close pruning. Light alloy handles are shaped to act as an extension of the forearm. The anvil blade handle is designed to prevent the pruner from sliding through the hand. This hollow ground, Swiss, precision, hardened steel blade features a wire-cutting notch. The blades are set on dowel pins for easy maintenance.

Item #	Desc	UPC	Vendor	CS/UOS	Location
80260014	Pruner	783929100067	118	50/1	East

Replacement Cutting Blades for Pruners

Packaged in an attractive blister pack. Includes rivets.



Item #	Desc	UPC	Vendor	CS/UOS	Location
80260001	#2-3	783929400013	1223	50/1	East

Replacement Spring Kit

Are your pruners listless and unresponsive? Do they open slowly or not at all? Put the spring back in your pruners. Pruner springs should be replaced every year for best performance. Made in Switzerland. Contains two springs (2-11).



Item #	Desc	UPC	Vendor	CS/UOS	Location
80260002	2 Pack	783929400181	12291	25/1	East

Mossify®

Garden Utility Shears

Mossify's Garden Utility Shears is the perfect tool for pruning your indoor and outdoor plants. Designed for effortlessly cutting old leaves, damaged branches, and growing vines, these stainless steel shears are an essential addition to your gardening toolkit. Ergonomic wooden handle

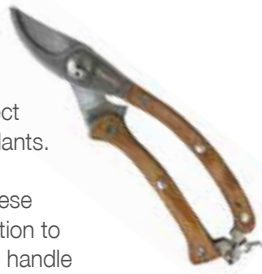

Item #	Desc	UPC	Vendor	CS/UOS	Location
82370055	8"	716252512290	GSHEAR-0001	12/12	National

Slim Garden Utility Shears

The Slim Garden Utility Shears are an essential addition to your gardening kit. These shears boast long, pointy stainless steel blades, giving you the ability to cut back foliage and vines with precision and ease. The comfortable, ergonomic wooden handle ensures a secure grip for those extended pruning sessions.



Item #	Desc	UPC	Vendor	CS/UOS	Location
82370056	8.5"	660111997035	SGSHEAR-0002	12/12	National

Orbit®



Contour Grip Steel Tools

Item #	Desc	UPC	Vendor	CS/UOS	Location
80340007	A Culti-Hoe	034613019043	1904	12/12	East
80341080	B Cultivator	718455022255	1951	12/12	East
80341081	C Transplanter	718455022262	1952	12/12	East
80341082	D Serrated Trowel	718455022279	1953	12/12	East

Promo Hand Tools

Baked-on enamel finished blades. Tough plastic handle with thumb groove.



Item #	Desc	UPC	Vendor	CS/UOS	Location
80340001	Cultivator	034613015014	1501	12/12	East

Bypass Anvil/Pruner Set

This two-piece set features die cast aluminum construction, textured TPR grips and an easy locking mechanism.



Item #	Desc	UPC	Vendor	CS/UOS	Location
80340786	2 pc.	034613048999	3105BL	12/12	East

Stainless Household Shears

Trim and shear quickly and easily with these household shears. For use in your kitchen or in your garden. Stainless steel construction means long lasting durability. A must have for any household.



Item #	Desc	UPC	Vendor	CS/UOS	Location
80340074	8"	034613048562	8131BL	6/6	East



Metal Handle Bypass Loppers

Perfectly sized for small hands and close work. This tool cuts with a clean scissor-like action, and features heat-treated blades to stay sharp for longer.

Item #	Desc	UPC	Vendor	CS/UOS	Location
80340098	24"	034613058264	5826	6/6	East

Pruning Combo Set

Set includes:
 *24" Bypass lopper
 *8 1/2" Wave edge hedge shear
 *8" bypass pruner

5 year guarantee



Item #	Desc	UPC	Vendor	CS/UOS	Location
80340181	3 pc.	034613059452	5945	6/6	East



Deluxe Springback Rake (A)

Heavy-duty spreader bar. Tines secured by coiled spring 54" wood handle 24" wide with continuous tempered steel tines.

Item #	Desc	UPC	Vendor	CS/UOS	Location
80340150	22"	034613009228	922	12/12	East
80340028	24"	034613009242	924	12/12	East

Adjustable Stainless Steel Rake (B)

The 15 steel tines on this rake adjust from 7" to 25" width, making it an ideal choice for raking in tight spaces like flowerbeds and around shrubs as well as general leaf and grass raking. The rakes head can be locked at any width with an easy to use lock on the steel handle. Rake expands from 48" length to 62" length when tines are extended at full width.

Item #	Desc	UPC	Vendor	CS/UOS	Location
80340734	Adjustable	034613120602	2060N	6/6	East

Long Handled Bow Rake (C)

54" fiberglass handle. 14-tine tempered and heat treated steel head for greater strength and longer life.

Item #	Desc	UPC	Vendor	CS/UOS	Location
80340123	60"	034613000065	LH006	6/6	East

Telescopic Tools

Telescoping tool has a strong, lightweight steel handle that adjusts from 25" to 37" in length for extra reach and leverage. Comfortable, soft, non-slip grip. Durable heat-treated head and rust-resistant powder-coated paint. Metal ring for convenient hanging storage.



Item #	Desc	UPC	Vendor	CS/UOS	Location
80340113	Culti-Hoe	034613000164	LH016	12/12	East
80340111	Shrub Rake	034613000133	LH013	12/12	East

Long Handled 4-Tine Cultivator (D)

54" fiberglass handle. Tempered, heat treated steel head for greater strength and longer life.

Item #	Desc	UPC	Vendor	CS/UOS	Location
80340122	54"	034613000058	LH005	6/6	East

D-Handle Fiberglass Round Point Shovel (E)

31" length fiberglass handle. Tempered, heat-treated steel for greater strength and longer life. Forward turned steps for secure footing on shovels. Sharpened blade edge penetrates tough ground with reduced effort.

Item #	Desc	UPC	Vendor	CS/UOS	Location
80340600	31"	034613000430	LH043	6/6	East

Fiberglass Round Point Shovel (F)

58" fiberglass handle. Tempered, heat-treated steel head for greater strength and longer life.

Item #	Desc	UPC	Vendor	CS/UOS	Location
80340119	58"	034613000027	LH002	6/6	East

Fiberglass Handle Wiggle Weeder (G)

This Bond wiggle weeder will help cut roots below the surface. It is made of tempered, heat-treated steel for greater strength and longer life. The handle is made of fiberglass. It has a sharpened edge which helps penetrate tough ground with reduced effort. It is designed for efficient moving and lifting. It has a comfortable soft non-slip grip.

Item #	Desc	UPC	Vendor	CS/UOS	Location
80340127	55"	034613000225	LH022	6/6	East

Poly Rake

This economical 24 inch rake with flexible plastic tines weighs only 1 lb. and comes in a bright blue color with a long wood handle.



Item #	Desc	UPC	Vendor	CS/UOS	Location
80340190	24"	034613048715	2124BL	12/12	East



Drop Forged Pruning Set

Heavy duty spring, easily taken apart for sharpening or cleaning, comfort cushion grip. Includes 5 year warranty



Item #	Desc	UPC	Vendor	CS/UOS	Location
80340178	3/4"	034613031083	3108	6/6	East

Bypass Lopper

Heat treated steel to stay sharper longer. Shock-absorbing wood handles. 1-1/2 - in cutting capacity. 21" bypass loppers



Item #	Desc	UPC	Vendor	CS/UOS	Location
80340097	21" Bypass lopper	034613033988	3398	6/6	East

2024



Home & Garden Handheld Sprayer

A full-featured sprayer in an economical package is perfect for homeowners. Use for general-purpose spraying, gardening applications and pest control.



Item #	Desc	UPC	Vendor	CS/UOS	Location
81140042	1 gal	720343211009	211	1/1	East

Battery Powered Back Pack Sprayer

Full-featured sprayer with easy-to-fill funnel top for general purpose spraying, garden applications, pest control, algae and mildew removers. Durable 24" poly wand with adjustable spray nozzle, 45" PVC hose, and shut-off valve assembly. TeeJet compatible. Includes large pump handle with built in wand retainer and pressure relief valve.



Item #	Desc	UPC	Vendor	CS/UOS	Location
81140038	2 gal.	720343424003	424-LI	1/1	East

One-Hand Sprayer

Chemical-resistant Viton seals for outstanding resistance to harsh chemicals. Multi-directional nozzle. Unique drift guard for added control for spot treatment. Locking trigger for reduced user fatigue.



Item #	Desc	UPC	Vendor	CS/UOS	Location
81140013	2 liter	720343419009	419	12/12	East



One Hand Sprayer (A)

Lightweight and versatile. these sprayers are perfect for general spraying around your home. both indoors and out. Weed control, gardening, auto and marine. Livestock applications and more. All offer many of the same features as our larger professional sprayers.

Item #	Desc	UPC	Vendor	CS/UOS	Location
81140008	1 gal	720343415001	415	12/12	East

Tank Sprayer (B)

Newly designed mid-price range sprayer incorporating a large filler opening and the popular funnel top concept. These have all Viton® seals, long hose, large pump handle and loads of other useful features. Includes an assortment of four nozzles: Adjustable Nozzle for spraying a steam to a mist; Flat Fan Nozzle for area and row application; Hollow Cone Nozzle for shrubs and bushes; and Jet Stream Nozzle for additional reach.

Item #	Desc	UPC	Vendor	CS/UOS	Location
81140005	2 gal.	720343432008	430-2G	1/1	East

2.25 gal Pro Handheld Sprayer (C)

Designed for medium-to-large jobs at home, on the farm, or for professional applications. The ultimate in hand-held sprayers, the 450 series is designed with the professional user in mind. This extremely heavy-duty sprayer will stand up to the toughest of jobs. High-performance, efficient piston pumps pressurize the tanks with as much as 50% more efficiency than the competitor's.

Item #	Desc	UPC	Vendor	CS/UOS	Location
41-3120	2.25 gal	720343456028	456	1/1	East



4 Gal Professional Piston Pump

Includes these four nozzles: adjustable brass, fan spray, hollow cone, and jet stream. TeeJet® compatible. Features an extra-large carrying handle with a wand retainer for easy portability and storage and a professional-grade adjustable brass nozzle. 28' wand, 48' nylon-reinforced hose, maximum pressure of 90 psi.



Item #	Desc	UPC	Vendor	CS/UOS	Location
81140025	4 gal.	720343425017	425-101	1/1	East

Backpack Sprayer

High-density polyethylene tank with ultra-violet inhibitors allows for unmatched. Large 4 1/4" opening for easy filling and cleaning. Shut-off valve and wand with an overall length of 28" for hard-to-reach places. 4' high-pressure hose. Padded shoulder straps for greater comfort. Chemically resistant Viton® seals insure long life and durability. With its connecting rod-activated piston pump, the 425° is capable of producing a wide pressure range of up to 90 psi, and is capable of performing virtually every spraying task.



Item #	Desc	UPC	Vendor	CS/UOS	Location
41-3130	4 gal.	720343425000	425	1/1	East

Multi-Purpose Sprayer, 2 Gallon

- Full-featured sprayer for general-purpose spraying, gardening applications and pest control. Works great with wood deck cleaners, as well as algae and mildew removers.
- Durable 24" poly wand and shut-off valve assembly.
- 45" PVC hose.
- Easy-to-fill funnel top.
- Plastic adjustable spray nozzle included. TeeJet® compatible.
- Large pump handle with a built-in wand retainer.
- Pressure relief valve.



Item #	Desc	UPC	Vendor	CS/UOS	Location
81140003	2 gal.	720343014068	406-US	1/1	East



All Around Upside Down Sprayer

Rotates 360 degrees allowing gardeners to spray at all angles. Full color graphic label with graduated dilution scale for exact measurement. Adjustable nozzle offers full stream and mist spray.



Item #	Desc	UPC	Vendor	CS/UOS	Location
81670001	32 oz.	046412104196	800419	6/6	National



Chemically Resistant Sprayer

High output dispenses 2.5 times more than standard trigger; Chemically-resistant extra long trigger for extended spray.

Item #	Desc	UPC	Vendor	CS/UOS	Location
81670011	32 oz.	046412076004	800660 DSP	12/12	National
81670018	Cardboard Floor Display	046412076004	801660	42/42	National



All Purpose Sprayer

Full color graphic label with graduated dilution scale for exact measurement. Adjustable nozzle offers full stream and mist spray.

Item #	Desc	UPC	Vendor	CS/UOS	Location
81670005	32 oz.	046412118889	800608	12/12	National
81670017	Cardboard Floor Display	046412118889	800936	42/42	National



Tapered Square Sprayer

Adjustable nozzle offers full stream or mist, perfect for misting your plants! Assorted case pack. 3 each blue, pink, green and purple

Item #	Desc	UPC	Vendor	CS/UOS	Location
8167009	12oz Assorted	046412103908	801031	12/12	National
81670016	Cardboard Floor Display	046412103908	801932	72/72	National

2024

Spray Bottle 3-Pack

Extended easy to press trigger with firm grip for accurate dispensing. Adjustable nozzle full stream and misty spray. Dilution scale for measurement, great for household cleaners, insecticides, weed killers and many other liquids.



Item #	Desc	UPC	Vendor	CS/UOS	Location
81670015	32 oz.	046412079999	801619	4/4	National

High Tech Clear Sprayer

Fully adjustable spray pattern. Assorted case pack - Orange, Gray, Teal



Item #	Desc	UPC	Vendor	CS/UOS	Location
81670004	14 oz.	046412000603	800201 DSP	12/12	National

Plant & Garden Sprayer

Perfect for indoor and outdoor garden needs. Full color graphic label with graduated dilution scale for exact measurement. Adjustable nozzle offers full stream and mist spray.



Item #	Desc	UPC	Vendor	CS/UOS	Location
81670012	16 oz.	046412907568	800307 DSP	24/24	National



Thank You Trunk Liners

1000 sheets classic Plastic Thank You Trunk liners

Item #	Desc	UPC	Vendor	CS/UOS	Location
81550002	1000 pc.	813269017722	18030	1/1	National

Thank You Biodegradable Trunk Liners

Large 45"x38" precut easy tear perforations, semi-transparent light green polyethylene sheets with a biodegrading agent. 1000 sheets per roll. Biodegrades one month in the sun, five years in a landfill



Item #	Desc	UPC	Vendor	CS/UOS	Location
81550005	1000 pc.	772911180361	18036	1/1	East



Little Pals Tool Pouch Kit

Includes green tool pouch, hand trowel, hand fork and children's garden gloves. Gloves have a wide cuff and extra fabric over the knuckles to help protect little hands. Glove design may vary

Item #	Desc	UPC	Vendor	CS/UOS	Location
81550787	Pink	501355612463	7-LP463	6/6	National
81550785	Blue	501355612441	7-LP441	6/6	National

Small Hand Tools

These colorful garden tools are perfect for the youngest gardeners ages 3-10! These tools are great for the garden or sandbox. 36 piece Assorted Case pack contains 12 each of square, round, and fork hand tools



Item #	Desc	UPC	Vendor	CS/UOS	Location
81550823	Square Trowel	692815212856	G340	12/12	National
81550824	Round Trowel	692815212855	G350	12/12	National
81550825	Fork	692815212857	G360	12/12	National
81551163	36-Piece Assorted	017783651039	G330	1/1	National

WATERING SUPPLIES & IRRIGATION



CHECK OUT OUR
CLEARANCE ITEMS!



Griffin Greenhouse Retail WAREHOUSE Shipping Map

We are now shipping nationwide!

NATIONAL



2024

Refer to location key:

National items are stocked nationally
 Select items are sold East or West only; no exceptions

8" Kaleidoscope Planter

Premium plastic modular planter can be displayed individually each planter has a removable saucer ideal for succulents or shallow rooted planted.

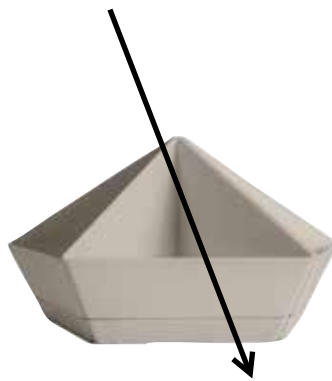

Item #	Desc	UPC	Vendor	CS/UOS	Location
80282643	Vanilla Bisque	770932844170	KDP08000A58	6/6	National

Where is the pricing?

1. Scan QR code on Chapter Pages to see pricing on Griffins.com
2. Contact your Griffin Sales Representative
3. Call into Griffin Customer Service 800.888.0054





bloem



Classic Watering Can Mix

Comfortable, easy-to-use handle. Long stem spout controls water flow. One-piece construction eliminates leaks. 100% UV stabilized polypropylene plastic ensures long lasting color and withstands extreme weather conditions + BPA free. 2gal Assorted contains four each of Yellow, Teal, and Blue. Watering can empty display pole, is made of metal and perfect for displaying watering cans inside the garden center or by the register for impulse add on sales.

Item #	Desc	UPC	Vendor	CS/UOS	Location
80922237	2gal Asst	087404003868	JW82-ASST-7 12/12		National
80922167	2gal Bermuda Teal	087404001659	JW82-26 12/12		National
80920970	Display pole- Watering cans sold separately	811214027864	H2OPOLE 1/1		East

Aqua Rite Mix Watercan Trend

Comfortable, easy-to-use handle. Long stem spout controls water flow. One-piece construction eliminates leaks. 100% UV stabilized polypropylene plastic ensures long lasting color and withstands extreme weather conditions + BPA free. Trendy mix case pack colors are Yellow, Bermuda Teal, and Blue



Item #	Desc	UPC	Vendor	CS/UOS	Location
80922233	56 oz Mix Trendy	087404003820	AW21-ASST-9 12/12		National
80922152	56oz-Yellow	814174029589	AW21-23 12/12		National
80922153	56oz-Bermuda Teal	814174029596	AW21-26 12/12		National
80922234	56oz-Classic Blue	087404003783	AW21-33 12/12		National
80922236	144oz-Classic Blue	087404003790	JW41-33 6/6		National
80922160	144oz-Bermuda Teal	087404001574	JW41-26 6/6		National
80922159	144oz-Yellow	087404001567	JW41-23 6/6		National
80922235	144oz Mix Trendy	087404003844	JW41-ASST-7 6/6		National

Deluxe Watering Can

Two handle design accomodates multiple hand positions for better maneuverability and water control. Wide mouth for easy filling. Twist off removable spout nozzle cap. 2.5gal capacity. Two each Earthy Yellow, Bermuda Teal, Classic Blue.



Item #	Desc	UPC	Vendor	CS/UOS	Location
80922239	2.5 gal Asst	087404003882	DWC2-ASST-7 6/6		National

Watering Can - Living Green

Designed with user-friendly handles for precise watering and easy carrying. Tapered handle ideal for tending potted plants. Deluxe features include large water capacity, wide mouth for easy filling, 2 handles for easy carrying. Capacity: 2 Gal./Size: 20.5 in. Top width x 20.5 in. Bottom width x 14 in. H x 6.75 in.



Item #	Desc	UPC	Vendor	CS/UOS	Location
80921851	2 gal	814174027141	JW82PROMO-42 10/10		National





bloem

Fern Watering Can

A sleek modern design, with a long spout for easy watering. Constructed of high-quality durable plastic. Maintenance free and easy to clean. UV-protected for fade resistance. Cement color



Item #	Desc	UPC	Vendor	CS/UOS	Location
80922417	1.5L	0847404007859	FWC1-907	10/10	National

Gold Finch Watering Can

This watering can is great for both indoor & outdoor watering needs. Provides easy visibility to water level. Water level markings are shown in gallon & liters for easy measuring. The loop handle offers multiple hand positioning for better maneuverability & control when watering.



Item #	Desc	UPC	Vendor	CS/UOS	Location
80921700	1.5L	087404341571	434157-4004	10/10	National

Sparrow Plastic Watering Can

Introducing our modern Sparrow 1.5 liter Watering Can with an ergonomic handle. Perfect for small to medium-sized plants, it's designed for comfortable use and features a sleek, stylish design. Whether you're an experienced gardener or just starting out, this watering can is a must-have tool for your plants.



Item #	Desc	UPC	Vendor	CS/UOS	Location
80922419	1.5L	087404007125	SWC1599	12/12	National



Hose End Sprayer Auto Mix

Simple to use, automatically mixes and applies the proper water to product dilution. No mixing, no measuring necessary, just hook up to garden hose. Unused concentrate can be returned to the original container. Twelve different mix settings with three spray patterns.



Item #	Desc	UPC	Vendor	CS/UOS	Location
80100047	Auto Mix	037321000518	51	6/6	National



Transparent Watering Can

1.4L indoor watering can. Assorted colors, two each of transparent green, red, yellow, dark blue, gray, and teal.

Item #	Desc	UPC	Vendor	CS/UOS	Location
82010747	1.4 Lt.-6 Asst	721082225500	V550	12/12	East

Haws Handy Plastic Watering Can

Our lightweight watering can is perfect for all ages, even kids. The ergonomic handle and small capacity make it easy to fill and pour.



Item #	Desc	UPC	Vendor	CS/UOS	Location
82010147	1.4 Lt.-6 Asst	5012868150556	V127	10/10	East



Galvanized Watering Can

These French inspired collection of rustic old-world farmhouse-style containers offers a charming flair to your home and garden. Can be used as a planter too! Measures 10½" x 10" x 4½"



Item #	Desc	UPC	Vendor	CS/UOS	Location
81370493	10" Galvanized	619216230189	23018	6/6	East

Galvanized Boutique De Fleur Watering Can

Rustic chic country perfectly weathered and expertly detailed that will add just the right touch of clever charm to any setting.



Item #	Desc	UPC	Vendor	CS/UOS	Location
801370814	Boutique Watering Can	619216080685	8068	12/12	East



Multi-Purpose Sprayer

A great tool to keep on your greenhouse tool shelf. Light in weight, these handheld sprayers are great for small jobs or detailed work.



Item #	Desc	UPC	Vendor	CS/UOS	Location
82210002	48 oz.	023883010027	1002	6/6	National
82210027	2L/67oz	023883100315	10031	6/6	National

Chapin Sprayer

For the quick and simple jobs around the house, inside and out. These units are compatible with common herbicides, pesticides, fertilizers and general cleaners. Both also, come with an ergonomic pump handle, poly wand with comfortable trigger shut-off, adjustable cone nozzle, and an in-tank filter for continuous spraying.



Item #	Desc	UPC	Vendor	CS/UOS	Location
82210029	1gal Home & Garden	023883161002	16100	1/1	National
82210031	1gal Multi-Purpose	023883200008	20000	1/1	National
82210030	2gal Home & Garden	023883162009	16200OPP	1/1	National
82210032	2gal Multi-Purpose	023883200022	20002	1/1	National
82210033	3gal Multi-Purpose	023883200039	20003	1/1	National

Poly Knapsack Sprayer

Designed for a turf professional in mind, this 4 gallon translucent tank contains a 3 stage filtration and positional pump handle allows you to comfortably control this unit whether you're left or right handed. It comes with chemical-resistant seals for harsher weed control, pest control or fertilizers. Multiple nozzles are included.



Item #	Desc	UPC	Vendor	CS/UOS	Location
82210059	4gal/15.1L	023883618001	61800	1/1	National

Wet or Dry Spray Hose

Whether you're fertilizing your plants, spraying to rid your yard of pesky weeds, or stopping insects from infiltrating your property, you can use both liquid or water-soluble lawn and garden chemicals in this sprayer. Attach to the end of a standard garden hose and it automatically mixes just the right amount of chemical with water.



Item #	Desc	UPC	Vendor	CS/UOS	Location
82210128	32 oz	023883060152	G6015	4/4	National

Zone Water Timer

Chapin makes it easy and affordable to add a water timer to your home garden system. Water timers regulate the amount of water consumed and can comply with municipal watering restrictions.



Item #	Desc	UPC	Vendor	CS/UOS	Location
82210142	Single Zone Timer	023883410117	41011	10/10	National
82210140	Dual Zone Water	023883410131	41013	1/1	National

Lawn & Garden Hose-end Sprayer

Hose end sprayers cover more ground when you're spraying rows of shrubs, large flower beds and vegetable gardens. You are able to spray fertilizers, pesticides and herbicides without mixing concentrate first. Chapin's 362D hose end sprayer with metering dial features a durable poly tank with comfort-grip handle, built-in anti-siphon to prevent backflow and brass mixing head with 16 mixing ratios. Switch from teaspoons to tablespoons for mixing measurements. It's made to fit any standard size garden hose and sprays up to 320 gallons from 32 ounces of concentrate. Fill, set and spray - it automatically mixes liquid concentrate with water. Made in the USA with global materials.



Item #	Desc	UPC	Vendor	CS/UOS	Location
82210122	32oz Hose End Sprayer	023883000097	G362D	6/6	National

Hose End Sprayer for Water Soluble Materials

Chapin's G390 20-gallon hose-end lawn sprayer fits onto any hose end and offers up to 20-gallons of finished spray with a 32-ounce chemical tank. A built-in anti-siphon feature prevents backflow into your water supply; fingertip on/off controls; durable, chemical-resistant and rustproof polyethylene construction. It automatically mixes liquid concentrate with water. Made in the USA with global materials.



Item #	Desc	UPC	Vendor	CS/UOS	Location
82210124	20gal Hose End	023883000035	G390	6/6	National

32-ounce Multi-purpose Trigger Sprayer

Chapin's 1055 trigger sprayer is compatible with common fertilizers, weed killers and pesticides. It's great for everyday tasks around the home, garden, cleaning or in the garage. This 32-ounce sprayer has a translucent plastic bottle so you easily see how full it is.



Item #	Desc	UPC	Vendor	CS/UOS	Location
82210005	32oz/1L	023883010553	1055	12/12	National

DRAMM

ColorStorm™ Water Timer

Carded. Mechanical water timer. Turns water off automatically. Up to 120 minute run time.

Assorted : 1 red, 1 orange, 1 yellow, 1 green, 1 blue and 1 berry.



Item #	Desc	UPC	Vendor	CS/UOS	Location
80170299	Red	036434150417	1015041	6/6	West
80170303	Blue	036434150455	1015045	6/6	West
80170300	Orange	036434150424	1015042	6/6	West
80170301	Yellow	036434150431	1015043	6/6	West
80170304	Berry	036434150462	1015046	6/6	West
80170302	Green	036434150448	1015044	6/6	West
80170021	Timer Asst Colors	036434150400	10-15040	6/6	National

2024

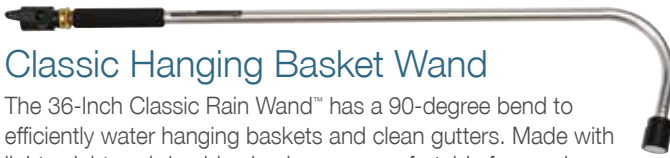

Classic Hanging Basket Wand

The 36-Inch Classic Rain Wand™ has a 90-degree bend to efficiently water hanging baskets and clean gutters. Made with lightweight and durable aluminum, a comfortable foam grip, and equipped with the QAV Shut-Off. Made in the USA.

Item #	Desc	UPC	Vendor	CS/UOS	Location
80170035	Uncarded	036434123589	10-12358	6/6	East



Handi-Reach™ Handle

Designed to eliminate the stretching and stooping associated with hand watering. These rugged tools allow you to water hard-to-reach areas with ease. Made from extruded aluminum tubing, forged brass hose couplings and a comfort EPDM hand grip. 3/4" male and female hose threads. 30" handi reach handle. Made in the USA.

Item #	Desc	UPC	Vendor	CS/UOS	Location
80170093	Carded	036434123626	10-12362	10/10	East



Classic Rain Wand™

Gentle full flow for quick thorough watering. Comfortable foam rubber grip. The 30" Classic Rain Wand™ has a sleek silver wand with water breaker head & shut-off valve. The rain wand can come with or without a vinyl card for pegboard display.

Item #	Desc	UPC	Vendor	CS/UOS	Location
80170004	Uncarded	036434123459	10-12345	24/24	East
80170022	Carded	036434223456	10-22345	12/12	East

Touch 'N Flow™ Rain Wand™

The Touch 'N Flow Rain Wand is equipped with a one-touch lever activated valve. Simply squeeze the lever to water and release the lever to stop watering while moving from one plant to the next.



Assortment: 3 berry, 2 blue, 3 green, 1 yellow, 1 orange & 2 red

Item #	Desc	UPC	Vendor	CS/UOS	Location
80170415	16" - Berry	036434128669	6012866	6/6	West
80170414	16" - Blue	036434128652	6012865	6/6	West
80170413	16" - Green	036434128645	6012864	6/6	West
80170412	16" - Red	036434128614	6012861	6/6	West
80170014	16" Assorted	036434128607	10-12860	12/12	East
80170411	30" - Berry	036434128065	6012806	6/6	West
80170410	30" - Blue	036434128058	6012805	6/6	West
80170409	30" - Green	036434128041	6012804	6/6	West
80170408	30" - Yellow	036434128034	6012803	6/6	West
80170407	30" - Orange	036434128027	6012802	6/6	West
80170406	30" - Red	036434128010	6012801	6/6	West
80170013	30" Uncarded Assorted	036434128126	10-12812	12/12	East

One Touch™ Rain Wand™

Allows complete and total water flow control with one touch of your thumb. Efficiently saves water while watering from one plant to the next. Made with heavy-duty aluminum for lightweight feel.



Assorted case pack contains; berry, blue, green, orange, yellow and red.

Item #	Desc	UPC	Vendor	CS/UOS	Location
80170461	16" - Berry	036434148667	6014866	6/6	West
80170460	16" - Blue	036434148650	6014865	6/6	West
80170459	16" - Green	036434148643	6014864	6/6	West
80170458	16" - Red	036434148612	6014861	6/6	West
80170045	16" Assorted	036434148602	10-14860	12/12	East
80170203	RainSelect Asst	036434136104	1013610	12/12	East
80170457	30" - Berry	036434148063	6014806	6/6	West
80170456	30" - Blue	036434148056	6014805	6/6	West
80170455	30" - Green	036434148049	6014804	6/6	West
80170454	30" - Yellow	036434148032	6014803	6/6	West
80170453	30" - Orange	036434148025	6014802	6/6	West
80170452	30" - Red	036434148018	6014801	6/6	West
80170044	30" Assorted	036434148008	10-14800	12/12	East

Kaleidoscope™ Rain Wand™

The kaleidoscope rain wand is the perfect tool for watering anything while efficiently saving on water. The seven patterns vary from a fine mist setting for seedlings, to the shower setting for mature plants and flowers. The seven patterns include sweeper, jet, shower, mist, flood, cone and flat.



Assorted case pack contains; berry, blue, green, orange, yellow and red.

Item #	Desc	UPC	Vendor	CS/UOS	Location
80170439	16" - Berry	036434138668	6013866	6/6	West
80170438	16" - Blue	036434138651	6013865	6/6	West
80170437	16" - Green	036434138644	6013864	6/6	West
80170436	16" - Red	036434138613	6013861	6/6	West
80170017	16" Assorted	036434138606	10-13860	12/12	East
80170435	30" - Berry	036434138064	6013806	6/6	West
80170434	30" - Blue	036434138057	6013805	6/6	West
80170433	30" - Green	036434138040	6013804	6/6	West
80170431	30" - Orange	036434138026	6013802	6/6	West
80170432	30" - Yellow	036434138033	6013803	6/6	West
80170430	30" - Red	036434138019	6013801	6/6	West
80170016	30" Assorted	036434138125	10-13812	12/12	East

RainSelect™ Rain Wand™

Select one of nine water patterns with the simple turn of a dial. Allows complete and total water flow control with just one touch of your thumb. Made with aluminum for a lightweight and durable feel. Available in six enticing colors.



Assorted case pack contains; berry, blue, green, orange, yellow and red.

Item #	Desc	UPC	Vendor	CS/UOS	Location
80170425	16" - Berry	036434136169	6013616	6/6	West
80170424	16" - Blue	036434136152	6013615	6/6	West
80170423	16" - Green	036434136145	6013614	6/6	West
80170422	16" - Red	036434136114	6013611	6/6	West
80170421	30" - Berry	036434136060	6013606	6/6	West
80170420	30" - Blue	036434136053	6013605	6/6	West
80170419	30" - Green	036434136046	6013604	6/6	West
80170418	30" - Yellow	036434136039	6013603	6/6	West
80170417	30" - Orange	036434136022	6013602	6/6	West
80170416	30" - Red	036434136015	6013601	6/6	West
80170202	30" Assorted	036434136005	10-13600	12/12	East

Sunrise™ Rain Wand™

Uncarded. Comfortable foam grip. Large, easy-to-use shut-off valve. Gentle, full flow for quick watering. Professional grade materials. Consumer lifetime guarantee. Made in the USA.



Assorted case pack contains; berry, blue, green, orange, yellow and red.

Item #	Desc	UPC	Vendor	CS/UOS	Location
80170379	16" - Berry	036434126030	6012603	6/6	West
80170377	16" - Blue	036434126016	6012601	6/6	West
80170378	16" - Green	036434126023	6012602	6/6	West
80170381	16" - Yellow	036434126054	6012605	6/6	West
80170380	16" - Orange	036434126047	6012604	6/6	West
80170376	16" - Red	036434126009	6012600	6/6	West
80170037	16" Assorted	036434120127	10-12012	12/12	East
80170373	30" - Berry	036434125835	6012583	6/6	West
80170371	30" - Blue	036434125811	6012581	6/6	West
80170372	30" - Green	036434125828	6012582	6/6	West
80170375	30" - Yellow	036434125880	6012582	6/6	West
80170374	30" - Orange	036434125873	6012587	6/6	West
80170370	30" - Red	036434125804	6012580	6/6	West
80170038	30" Assorted	036434100129	10-10012	12/12	East
80170040	30" carded	036434000095	10-00009	12/12	East

ColorMark™ Rain Wand™

This superbly balanced 30-Inch Rain Wand is used by professional growers and horticulturists worldwide. It provides a gentle, full-flow shower. It has a handcrafted brass shut-off and a foam grip for comfortable watering. Available in six rich colors and made in the USA.

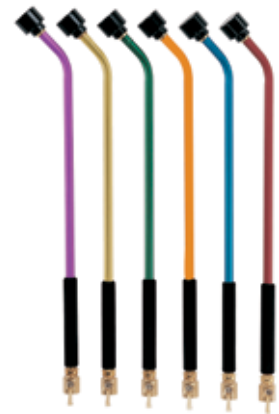

Assorted case pack contains; berry, blue, green, orange, yellow and red.

Item #	Desc	UPC	Vendor	CS/UOS	Location
80170368	30" - Berry	036434125033	6012503	6/6	West
80170474	30" - Gold	036434224316	6022341	6/6	West
80170367	30" - Green	036434125026	6012502	6/6	West
80170369	30" - Orange	036434125040	6012504	6/6	West
80170366	30" - Blue	036434125019	6012501	6/6	West
80170365	30" - Red	036434125002	6012500	6/6	West
80170041	30" Assorted	036434100006	10-10000	12/12	East

DRAMM



2024

400 Plastic Water Breaker® Nozzle (A)

Provides fast, full-flow watering without damage to your plants. Professional's lightweight alternative to the 400AL. ABS plastic & aluminum. Gentle, full flow at 11.1 gpm. Used by professional growers worldwide. Has 3/4" hose threads. Made in the USA.

Item #	Desc	UPC	Vendor	CS/UOS	Location
80170179	Carded	036434123466	60-12346	6/6	East

170 Plastic Water Breaker® Nozzle (B)

Patterned after the 170 Aluminum water breaker. An excellent choice for watering in areas with low water pressure or with systems which restrict total water volume. It is designed for small containers (hanging baskets). Adjust water flow to 50% of its possible volume. Made from ABS plastic. 3/4" hose threads. Made in the USA.

Item #	Desc	UPC	Vendor	CS/UOS	Location
80170180	Carded	036434123497	60-12349	6/6	East

170 Aluminum Water Breaker® Nozzle (C)

Excellent for watering in areas with low water pressure or with systems which restrict total water volume. It is designed for small containers (hanging baskets), and when using fertilizer siphons. Adjust water flow to 50% of its possible volume. Cast aluminum with 3/4" brass hose threads. Made in the USA.

Item #	Desc	UPC	Vendor	CS/UOS	Location
80170177	Carded	036434123435	60-12343	6/6	East

400 Die Cast Aluminum Water Breaker (D)

The 400DC Water Breaker is a lighter weight version of the original Aluminum 400 Water Breaker. Designed for the greenhouse and nurseryman, this lightweight nozzle saves time and water. 400 tiny holes provide a gentle, full-flow shower for flowers. Simply attached the nozzle to the end of your hose to water.

Item #	Desc	UPC	Vendor	CS/UOS	Location
80170176	Carded	036434123428	60-12342	6/6	East

1000 Plastic Water Breaker® Nozzle

The 1000PL Water Breaker Nozzle is great for container and garden bed watering. Originally designed for greenhouses and nurseryman, this lightweight nozzle has 1000 tiny holes to provide an ultra-soft, full-flow shower for flowers. Simply attached the nozzle to the end of your hose and away you go. Won't harm delicate soil or tender plants and seedlings. Made in the U.S.A. with a highly durable plastic and comes with a manufacturer's consumer lifetime guarantee.



Item #	Desc	UPC	Vendor	CS/UOS	Location
80170174	Carded	036434110008	60-11000	6/6	East



Garden Gard™ Hose Guides (E)

Box Display. Guides hose around flowers, shrubs and sharp corners. Pulling hose is easy with spinning post design. Quick mowing with removable post design. Made in the USA.

Item #	Desc	UPC	Vendor	CS/UOS	Location
80170015	Hose Guides	036434130013	1013001	12/12	East

Brass Hose Swivel (F)

Live swivel that allows for unencumbered movement between the hose & attachments under pressure. Reduces hose twisting. Made in the USA.

Item #	Desc	UPC	Vendor	CS/UOS	Location
80170199	Brass	036434138255	60-13825	6/6	East

Carded Replacement Washers (G)

Great for leak-free hose connections in all standard 3/4" garden hose couplings. Molded from high-quality virgin neoprene. Dramm washers stay soft and pliable for years, while common nylon washers become brittle with age.

Item #	Desc	UPC	Vendor	CS/UOS	Location
80170175	3/4"	036434123404	60-12340	6/6	East

Brass Adjustable Nozzle (H)

Adjustable Hose Nozzle is a great cleanup nozzle for walkways, patios and gutters, and also works to gently water and rinse your plants.

Item #	Desc	UPC	Vendor	CS/UOS	Location
80170185	Adjustable Nozzle	036434123800	6012380	6/6	National

DRAMM



One Touch Shower & Stream™

Complete & total water flow control with just on touch of your thumb. Has two pattern options: Shower, for a cascading flow of fine water droplets that will not harm your plants, and Stream, a concentrated jet. Assorted case pack contains; berry, blue, green, orange, yellow and red.



Item #	Desc	UPC	Vendor	CS/UOS	Location
80170346	Berry	036434124265	6012426	6/6	West
80170345	Blue	036434124258	6012425	6/6	West
80170344	Green	036434124241	6012424	6/6	West
80170343	Yellow	036434124234	6012423	6/6	West
80170342	Orange	036434124227	6012422	6/6	West
80170341	Red	036434124210	6012421	6/6	West
80170048	Assorted Carded	036434124203	10-12420	12/12	East

Pistol™ Spray Gun

Revised to closely resemble the Damm's Revolver™ Spray Gun. Redesigned with a larger barrel for a more consistent spray pattern and a insulated comfort grip for a better look and feel. Made with a heavy-duty metal for a longer life. Assorted case pack contains; berry, blue, green, orange, yellow and red.



Item #	Desc	UPC	Vendor	CS/UOS	Location
80170399	Berry	036434127266	6012726	6/6	West
80170398	Blue	036434127259	6012725	6/6	West
80170397	Green	036434127242	6012724	6/6	West
80170396	Yellow	036434127235	6012723	6/6	West
80170395	Orange	036434127228	6012722	6/6	West
80170394	Red	036434127211	6012721	6/6	West
80170012	Assorted Uncarded	036434127204	10-12720	12/12	East

Revolution™ 9-Pattern Spray Gun

Easily switch between water flow selections with the quick-change feature. Equipped with the One Touch Valve allowing complete and total water flow control with just one touch of the thumb. It has an ergonomic design, is constructed from heavy-duty metal. The spray gun can come with or without a vinyl card for pegboard display. Assorted case pack contains; berry, blue, green, orange, yellow and red.



Item #	Desc	UPC	Vendor	CS/UOS	Location
80170445	Berry Uncarded	036434145062	6014506	6/6	West
80170444	Blue Uncarded	036434145055	6014505	6/6	West
80170443	Green Uncarded	036434145048	6014504	6/6	West
80170442	Yellow Uncarded	036434145031	6014503	6/6	West
80170441	Orange Uncarded	036434145024	6014502	6/6	West
80170440	Red Uncarded	036434145017	6014501	6/6	West
80170162	Assorted Uncarded	036434145007	10-14500	12/12	East
80170486	Berry Carded	036434245069	6024506	6/6	West
80170485	Blue Carded	036434245052	6024505	6/6	West
80170484	Green Carded	036434245045	6024504	6/6	West
80170483	Yellow Carded	036434245038	6022704	6/6	West
80170482	Orange Carded	036434245021	6024502	6/6	West
80170481	Red Carded	036434245014	6022702	6/6	West
80170166	Assorted Carded	036434345001	10-34500	12/12	East

Revolver™

Durable metal with nine spray patterns. Has an Ergonomic insulated grip. Made with heavy-duty construction. Quick-click pattern changing. Assorted case pack contains; berry, blue, green, orange, yellow and red.



Item #	Desc	UPC	Vendor	CS/UOS	Location
80170387	Berry Uncarded	036434127068	6012706	6/6	West
80170386	Blue Uncarded	036434127051	6012705	6/6	West
80170385	Green Uncarded	036434127044	6012704	6/6	West
80170384	Yellow Uncarded	036434127037	6012703	6/6	West
80170383	Orange Uncarded	036434127020	6012702	6/6	West
80170382	Red Uncarded	036434127013	6012701	6/6	West
80170011	Assorted Uncarded	036434127006	10-12700	12/12	East
80170480	Berry Carded	036434227065	6022706	6/6	West
80170479	Blue Carded	036434227058	6022705	6/6	West
80170478	Green Carded	036434227041	6022704	6/6	West
80170477	Yellow Carded	036434227034	6022703	6/6	West
80170476	Orange Carded	036434227027	6022702	6/6	West
80170475	Red Carded	036434227010	6022701	6/6	West
80170025	Assorted Carded	036434137005	10-32700	12/12	East

DRAMM

One Touch™ Fan Nozzle

Corrosion proof head creates a precise and gentle water pattern that won't harm delicate plants and seedling – Great for watering containers, plants and shrubbery. Assorted: 2 red, 2 orange, 2 yellow, 2 green, 2 blue, 2 berry.



Item #	Desc	UPC	Vendor	CS/UOS	Location
80170405	Berry	036434127365	6012736	6/6	West
80170404	Blue	036434127358	6012735	6/6	West
80170403	Green	036434127341	6012735	6/6	West
80170402	Yellow	036434127334	6012733	6/6	West
80170401	Orange	036434127327	6012732	6/6	West
80170400	Red	036434127310	6012731	6/6	West
80170047	Assorted Carded	036434127300	10-12730	12/12	East

2024

Fan Nozzle

Heavy duty metal with 1/4 turn valve. Ergonomic insulated grip. Limited lifetime guarantee. Assorted case pack contains; berry, blue, green, orange, yellow and red.



Item #	Desc	UPC	Vendor	CS/UOS	Location
80170393	Berry	036434127167	6012716	6/6	West
80170392	Blue	036434127150	6012715	6/6	West
80170391	Green	036434127143	6012714	6/6	West
80170390	Yellow	036434127136	6012713	6/6	West
80170389	Orange	036434127129	6012712	6/6	West
80170388	Red	036434127112	6012711	6/6	West
80170046	Assorted Colors	036434127102	10-12710	12/12	East

One Touch™ Adj Twist Nozzle

What a great tool for cleaning decks, sidewalks, cars and more! Dramm's "Twist" Adjustable Spray Gun's spray pattern can be adjusted from a cone of fine mist all the way up to a powerful jet for quick and easy cleanup. Assorted case pack contains; berry, blue, green, orange, yellow and red.



Item #	Desc	UPC	Vendor	CS/UOS	Location
80170451	Berry	036434145161	6014516	6/6	West
80170450	Blue	036434145154	6014515	6/6	West
80170449	Green	036434145147	6014514	6/6	West
80170448	Yellow	036434145130	6014513	6/6	West
80170447	Orange	036434145123	6014512	6/6	West
80170446	Red	036434145116	6014511	6/6	West

Sunrise™ Hanging Basket Wand

The 36-Inch Sunrise Hanging Basket Wand™ has a 90-degree bend to efficiently water hanging baskets and clean gutters. Made with lightweight and durable aluminum, a comfortable foam grip, and equipped with the QAV Shut-Off. Made in the USA and available in blue.



Item #	Desc	UPC	Vendor	CS/UOS	Location
80170039	36"	036434125798	10-12579	6/6	East



Telescoping Rain Wand

9 Pattern nozzle with thumb controlled valve. Versatile watering tool for those hard to reach places. Adjustable length from 34 inches to 55 inches puts all your watering jobs within reach.

Item #	Desc	UPC	Vendor	CS/UOS	Location
80170429	Berry	036434136268	6013626	6/6	West
80170428	Blue	036434136251	6013625	6/6	West
80170427	Green	036434136244	6013624	6/6	West
80170426	Red	036434136213	6013621	6/6	West



ColorStorm™ Pattern Gear Sprinkler

Mounted to a die-cast metal sled base, the gear drive sprinkler is a great mobile, flexible sprinkler for a variety of watering applications. Each pattern can be selected by the simple twist of the selector dial. Lifetime consumer guarantee.

Item #	Desc	UPC	Vendor	CS/UOS	Location
80170334	Berry	036434150967	1015096	6/6	West
80170333	Blue	036434150950	1015095	6/6	West
80170332	Green	036434150943	1015094	6/6	West
80170331	Yellow	036434150936	1015093	6/6	West
80170330	Orange	036434150929	1015092	6/6	West
80170329	Red	036434150912	1015091	6/6	West

Stake Impulse Sprinkler

Carded. Durable metal with an all brass sprinkler head. Up to 80' diameter. Has a 6" stake with step. Assorted case pack contains; berry, blue, green, orange, yellow and red.



Item #	Desc	UPC	Vendor	CS/UOS	Location
80170312	Orange	036434150622	1015062	6/6	West
80170311	Red	036434150615	1015061	6/6	West
80170313	Yellow	036434150639	1015063	6/6	West
80170316	Berry	036434150660	1015056	6/6	West
80170315	Blue	036434150653	1015065	6/6	West
80170314	Green	036434150646	1015064	6/6	West
80170050	Assorted	036434150506	10-15060	6/6	East

Circular Base Impulse Sprinkler

Made with a heavy-duty circular metal base for increased stability and a unique style. The all brass sprinkler head has adjustable partial and full circle patterns with water coverage up to 70 Ft. in diameter. Backed with a lifetime guarantee to the consumer Assorted includes: red, orange, yellow, green, blue and berry.



Item #	Desc	UPC	Vendor	CS/UOS	Location
80170326	Green	036434150844	1015084	6/6	West
80170323	Red	036434150813	1015081	6/6	West
80170327	Blue	036434150851	1015085	6/6	West
80170324	Orange	036434150820	1015082	6/6	West
80170328	Berry	036434150868	1015086	6/6	West
80170325	Yellow	036434150837	1015083	6/6	West
80170052	Assorted	036434150608	10-15080	6/6	East

ColorStorm™ Impulse Sprinkler

Durable metal with an all brass sprinkler head. Waters up to 70' diameter. Assorted includes: red, orange, yellow, green, blue, berry.



Item #	Desc	UPC	Vendor	CS/UOS	Location
80170293	Red	036434150318	1015031	6/6	West
80170294	Orange	036434150325	1015032	6/6	West
80170295	Yellow	036434150332	1015033	6/6	West
80170296	Green	036434150349	1015034	6/6	West
80170297	Blue	036434150356	1015035	6/6	West
80170298	Berry	036434150363	1015036	6/6	West
80170020	Assorted	036434150308	10-15030	6/6	East

ColorStorm™ Turret Sprinkler

Heavy-duty metal base with molded hook for convenient storage. Nine water patterns. Assorted includes – red, orange, yellow, green, blue, berry.



Item #	Desc	UPC	Vendor	CS/UOS	Location
80170292	Berry	036434150264	1015026	6/6	West
80170291	Blue	036434150257	1015025	6/6	West
80170290	Green	036434150240	1015024	6/6	West
80170289	Yellow	036434150233	1015023	6/6	West
80170288	Orange	036434150226	1015022	6/6	West
80170287	Red	036434150219	1015021	6/6	West
80170019	Assorted	036434150202	10-15020	6/6	East

Whirling Sprinkler

Heavy-duty metal wheeled base. Available in 6 brilliant colors: red, orange, yellow, green, blue and berry. Water coverage up to 38 Ft. in diameter Durable metal 3 arm sprinkler head Made from zinc, brass, and heavy-duty plastic.



Item #	Desc	UPC	Vendor	CS/UOS	Location
80170305	Red	036434150516	1015051	6/6	West
80170306	Orange	036434150523	1015052	6/6	West
80170307	Yellow	036434150530	1015053	6/6	West
80170308	Green	036434150547	1015054	6/6	West
80170309	Blue	036434150554	1015055	6/6	West
80170310	Berry	036434150561	1015056	6/6	West
80170049	Assorted	036434150608	1015050	6/6	East

ColorStorm™ Spinning Sprinkler

Keep your lawn and other growing things happy even in the heat with the Dramm ColorStorm Spinning Sprinkler. The motion of this unit atomizes water into small droplets, leading to better absorption and more efficient watering.. Assorted includes – red, orange, yellow, green, blue, berry.



Item #	Desc	UPC	Vendor	CS/UOS	Location
80170322	Berry	036434150769	1015076	6/6	West
80170321	Blue	036434150752	1015075	6/6	West
80170320	Green	036434150745	1015074	6/6	West
80170319	Yellow	036434150738	1015073	6/6	West
80170318	Orange	036434150721	1015072	6/6	West
80170317	Red	036434150714	1015071	6/6	West

DRAMM

Oscillating Sprinkler

Re-engineered drive system for longer life. Newly designed housing for increased stability. Enlarged pattern controls for ease of adjustment. Variable settings allow coverage up to 3,036 sq. ft. Assorted case pack contains; berry, blue, green, orange, yellow and red.



Item #	Desc	UPC	Vendor	CS/UOS	Location
80170281	Red	036434150011	1015001	6/6	West
80170282	Orange	036434150028	1015002	6/6	West
80170283	Yellow	036434150035	1015003	6/6	West
80170284	Green	036434150042	1015004	6/6	West
80170285	Blue	036434150059	1015005	6/6	West
80170286	Berry	036434150066	1015006	6/6	West
80170018	Assorted	036434150004	10-15000	6/6	East

2024

5-Liter Watering Can

Superior design and balance made from high-grade injection molded plastic. Consumer lifetime guarantee. Assorted colors in red, orange, yellow, green, blue & berry. Made in the USA.



Item #	Desc	UPC	Vendor	CS/UOS	Location
80170169	5 Liter	036434124502	60-12450	6/6	National



7-Liter Watering Can

Superior design. High-grade, injection molded plastic with plastic rosette. Lifetime guarantee. 6 bright colors. Made in the USA.

Item #	Desc	UPC	Vendor	CS/UOS	Location
80170167	7 Liter	036434124304	60-12430	6/6	National



2-Liter Watering Can

Superior design and balance made from high-grade injection molded plastic. Consumer lifetime guarantee. Assorted colors in red, orange, yellow, green, blue & berry. Made in the USA.

Item #	Desc	UPC	Vendor	CS/UOS	Location
80170168	2 Liter	036434124403	60-12440	6/6	National



ColorStorm™ Premium Rubber Hose

Hot water resistant up to 160°F. Resists kinking. Coils easily even in cold weather. Crush proof, nickel plated coupling. 6 Assorted colors.

Item #	Desc	UPC	Vendor	CS/UOS	Location
80170335	Red	036434170019	1017001	6/6	West
80170336	Orange	036434170026	1017002	6/6	West
80170337	Yellow	036434170033	1017003	6/6	West
80170338	Green	036434170040	1017004	6/6	West
80170339	Blue	036434170057	1017005	6/6	West
80170340	Berry	036434170064	1017006	6/6	West
80170053	Assorted	10036434170009	10-17000	6/2	East

DRAMM

ColorStorm™ Premium Soaker Hose

Constructed with a unique design that provides deep, thorough watering for your grass and flowers while using 90% less water. This handy hose is constructed of high-grade rubber with 50% thicker walls that eliminate the "geyser effect", saving water waste, and helping to reduce evaporation. Crush-proof, nickel-plated couplings provide a leak-proof connection.



Item #	Desc	UPC	Vendor	CS/UOS	Location
80170054	5/8"x50'	036434170101	10-17010	6/6	East



QAV Shut-Off Valve (A)

Provides fingertip water control with large ergonomic handle made from high grade black ABS plastic. Made in the USA.

Item #	Desc	UPC	Vendor	CS/UOS	Location
80170233	6"x4"x2"	036434223180	60-22318	6/6	East

Heavy Duty Plastic Shut-Off Valve (B)

The 74 Shut-off valve is made from glass filled polypropylene to be very durable and corrosion resistant. More durable than other plastic valves, the 74 is lightweight and offers a full flow. Made in the USA.

Item #	Desc	UPC	Vendor	CS/UOS	Location
80170197	4"x2"x2"	036434227324	60-22732	6/6	National

Brass Shut-Off Valve (C)

Best shut-off valve available. Dramm's #300 Brass Shut-Off Valve provides fingertip water control at the end of your greenhouse hose. A quarter turn of the large ergonomic handle and the water is off. Full water flow design. Made from brass, durable seals and a hard chrome plated ball to provide years of service. 3/4 threads.

Item #	Desc	UPC	Vendor	CS/UOS	Location
80170183	2"x2"x3"	036434123534	60-12353	6/6	National

Aluminum Shut-Off Valve (D)

Light weight, durable, full flow. The Aluminum shut off offers durability in a light weight package. Identical to our #300 brass shut off in design and operation, we have manufactured the body from lighter weight aluminum.

Item #	Desc	UPC	Vendor	CS/UOS	Location
80170192	4"x2"x2"	036434223739	60-22373	6/6	East

Tripod Impulse Sprinkler

The Tripod Impulse Sprinkler stands at 5 feet in height and features a brass impulse sprinkler head for adjustable partial and full-circle patterns, waters an area up to 70 feet in diameter. The retractable stake base design secures the tripod in place while you customize the height and spray area coverage. The overhead watering simulates natural rain to quickly and evenly distribute a gentle, soaking shower. Available carded and in an eye-catching blue color.



Item #	Desc	UPC	Vendor	CS/UOS	Location
80170265	Blue Tripod Sprinkler	036434151056	15105	1/1	East

Gilmour

Hoses Nozzles Sprinklers

Steel Hose Hanger

Holds 50' to 150' of hose. Easy hose storage over faucet.

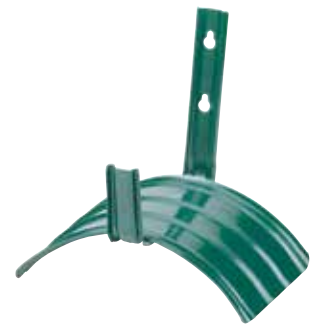

Item #	Desc	UPC	Vendor	CS/UOS	Location
80150206	Steel	034411081150	881154-1001	12/12	National

Aluminum Hose Hanger

Durable, corrosion-resistant aluminum. Keyhole design for easy installation.



Item #	Desc	UPC	Vendor	CS/UOS	Location
80150207	Aluminum	034411082157	882154-1001	12/12	National

8015 Hose Hanger

Durable polymer construction. Includes storage rack for nozzles, sprayers or gloves.



Item #	Desc	UPC	Vendor	CS/UOS	Location
80150208	Polymer	034411080153	880154-1001	12/12	National

Round Soaker Hose

Ideal for new plantings, shrubs, bushes and raised beds, the soaker hose releases water from a flexible, vinyl hose directly into the soil. Water without waste by delivering a steady stream no faster than the ground can absorb it, deep into the soil-not pooling on top of it.



Item #	Desc	UPC	Vendor	CS/UOS	Location
80151291	5/8" X 25'	034411927748	827251-1005	6/6	West
80151292	5/8" X 50'	034411927755	827501-1005	6/6	West

Flexogen® Super Duty Hose

Exceptionally rugged, abrasion-resistant with a polished surface that stays clean and resists scuffing and stains. 8-ply construction - 500 PSI burst strength. Double tire cord reinforced for strength, yet is lightweight and coils and handles easily. Kink resistant. Heavy-duty, crush resistant, Full-Flo machined metal couplings with built in washer for tight sealing.



Item #	Desc	UPC	Vendor	CS/UOS	Location
80151159	5/8" X 25'	034411742518	874251-1003	6/6	West
80150022	5/8" X 50'	034411112038	874501-1021	6/6	West
80151285	5/8" X 75'	034411745014	874751-1004	4/4	West
80150024	5/8" X 100'	034411112052	874001-1021	2/2	West

Flexogen® Heavy Duty Hose

The strongest, lightest hose in its class, Flexogen delivers superior all around performance for your lawn, garden, deck and driveway. The hose features a patented 8-layer construction with reinforced core to maximize durability. Count on a Flexogen garden hose to curve without kinking, connect without leaking and hold up season upon season.



Item #	Desc	UPC	Vendor	CS/UOS	Location
80151169	3/4" X 25'	034411112069	843251-1003	5/5	National
80151170	3/4" X 50'	034411112076	843501-1003	4/4	National
80151171	3/4" X 75'	034411112083	843751-1003	2/2	National
80151168	3/4" X 100'	034411112090	843001-1002	1/1	National
80151173	5/8" X 25'	034411642511	864251-1016	6/6	National
80151174	5/8" X 50'	034411645017	864501-1021	6/6	National
80151175	5/8" X 75'	034411647516	864751-1017	4/4	National
80151172	5/8" X 100'	034411261057	864001-1020	2/2	National

Medium Duty Hose

Lightweight, yet durable Easy to maneuver around your outdoor spaces for routine watering and cleaning.



Item #	Desc	UPC	Vendor	CS/UOS	Location
80151280	5/8" X 25'	034411603185	816251-1014	10/10	National
80151281	5/8" X 50'	034411030103	816501-1014	6/6	National
80151282	5/8" X 75'	034411030110	816751-1014	4/4	National
80151278	5/8" X 100'	046561006679	816001-1014	2/2	National

Tube Sprinkler Hose

Water narrow, curved or irregular patches of lawn with this 2-in-1 sprinkler and soaker hose. A low spray releases water at a consistent, controlled rate - perfect for new grass.



Item #	Desc	UPC	Vendor	CS/UOS	Location
80151290	50'	034411261231	871421-1004	10/10	National

Flat Weeper Hose

This flexible soaker hose gets water right where you want it: at the roots. Water seeps out of all sides of the fabric jacket and directly into the soil, for waste-free watering in garden beds and other tight spaces. Flat design makes it a breeze to roll up and store it for next season.



Item #	Desc	UPC	Vendor	CS/UOS	Location
80150249	5/8" x 50'	034411927748	870501-1004	12/12	National
80150250	5/8" x 75'	034411927755	870751-1004	12/12	National

Marine & Recreation Hose

Outstanding durability and flexibility make it perfect for year-round use. With non-marring blue-striped white cover, Full-Flo® brass couplings and EZ-on coupler. Blue protective collar on 5/8".



Item #	Desc	UPC	Vendor	CS/UOS	Location
80151294	5/8" X 50'	034411263617	894501-1003	6/6	West



Poly Trigger Nozzle (A)

A good hose nozzle is a staple of every gardener's toolbox. Gilmour models provide just the spray pattern you need. Select a specially designed nozzle for unique applications.

Item #	Desc	UPC	Vendor	CS/UOS	Location
80150034	424	034411004746	804742-1001	12/12	East
80150361	474FARM	034411247426	804742-1002	12/12	West

Classic Full Metal Nozzle (B)

Heavy duty full size chrome plated zinc body, insulated molded grip for spraying hot or cold water, ideal for commercial or industrial use, brass head insert for maximum resistance to extremely hot water, solid brass valve stem with permanent adjusting nut, hold-open clip for continuous spraying, rust resistant stainless steel spring, self-adjusting "duck" packing for lifetime leakproof seal, male hose threaded front for attaching accessories, rubber head guard to protect threads.

Item #	Desc	UPC	Vendor	CS/UOS	Location
80150360	572TFR	034411057216	805722-1011	12/12	West

Full Size Metal Nozzle (C)

Solid brass valve stem with permanent adjusting nut. Hold-open clip for continuous spraying. Rust resistant stainless steel spring. Self-adjusting "duck" packing for the ultimate leak proof seal. Heavy-duty, mid-size, die cast zinc body.

Item #	Desc	UPC	Vendor	CS/UOS	Location
80150040	573TF	034411057315	857302-1011	12/12	East

Comfort Grip Nozzle W/ Threaded Front (D)

Molded on, black vinyl grip for cushioned comfort. Male hose threaded front for attaching accessories. Solid brass valve stem with permanent adjusting nut. Hold-open clip for continuous spraying. Rust resistant stainless steel spring. Self-adjusting "duck" packing for lifetime leak proof seal. Heavy-duty, full size, die cast zinc body.

Item #	Desc	UPC	Vendor	CS/UOS	Location
80150043	593	034411262733	805932-1011	12/12	National

Insulated Threaded Front Nozzle (E)

Insulated pistol-grip handle for hot or cold water. Solid brass valve stem. Hold-open clip for continuous spraying. Male-threaded head allows attachment of accessories. Stainless steel spring won't rust.

Item #	Desc	UPC	Vendor	CS/UOS	Location
80150038	571TFR	034411057117	857102-1011	1/12	West

Master Rear Trigger Pistol Nozzle (F)

The Gilmour brand exists to meet the needs of gardeners and home owners who demand the very best for their lawns and gardens. With over 100 years of lawn and garden service, Gilmour is proud of its heritage rooted in quality, innovation, and value.

Item #	Desc	UPC	Vendor	CS/UOS	Location
80150265	210GCR	034411028063	821022-1002	18/18	West



Swivel Connect Adjustable Nozzle

The Gilmour Control Watering Nozzle with Swivel Connect provides the most comfortable nozzle experience available, with 8 pre-set patterns to cover every watering need. Its Swivel Connect coupling pivots without twisting the hose, reducing kinks by 70%, and it provides a 50% reduction in torque, making it much easier to pull around the yard while keeping the hose straight.

Item #	Desc	UPC	Vendor	CS/UOS	Location
80151124	Front Trigger	034411262733	825602-1001	12/12	West
80151126	Rear Trigger	034411262658	825202-1001	12/12	West
80151125	Thumb Trigger	034411262696	825402-1001	12/12	West

Faucet Hose Extender

The heavy-duty Gilmour faucet watering hose extender allows you to extend your faucet past plants and bushes. It boasts 500 PSI burst strength, heavy-duty metal couplings, and an impact-resistant spike to hold the hose faucet securely. Measuring 6' in length, it is designed for hoses 5/8" in diameter. This product is backed by a lifetime warranty.



Item #	Desc	UPC	Vendor	CS/UOS	Location
80150049	Faucet Extender	034411010761	800604-1005	10/10	West

Jet Water Nozzle

Sprays a concentrated jet stream. Attaches to threaded front nozzles or hose end. Not recommended for hot water over 140 degrees. Impact resistant, rustproof polymer construction.



Item #	Desc	UPC	Vendor	CS/UOS	Location
80150339	Plastic Nozzle	034411000069	806032-1001	12/12	West

Brass Solid Water Jet Nozzle

This classic straight nozzle features durable brass construction and easily attaches to threaded-front nozzles or the end of a hose for added cleaning power.



Item #	Desc	UPC	Vendor	CS/UOS	Location
80150340	Brass Jet	034411000618	806002-1001	12/12	West

Adjustable Twist Nozzle

Perfect for watering the garden or general cleanup, the Gilmour Solid Brass Garden Hose Spray Nozzle is made from heavy-duty brass. Four large openings at nozzle head allow for full flow with a precise tip angle that eliminates side spray. Adjustable from a fine spray to a needle stream to a heavy stream.



Item #	Desc	UPC	Vendor	CS/UOS	Location
80150345	528T Brass	034411125281	852812-1001	12/12	West
80150342	529 Rubber Grip	034411005293	805292-1001	12/12	West

Twist Nozzle w/ Rubber Grip

Solid brass construction. All brass valve stem. Four large openings at nozzle tip for full flow. Replaceable front and rear O-ring seals for leakproof shut-off. Precise tip angle eliminates side spray. Adjustable from fine spray to needle stream to heavy rinse.



Item #	Desc	UPC	Vendor	CS/UOS	Location
80150036	Twist Nozzle	034411005286	805282-1001	12/12	East

Power Flow Nozzle

Professional Twist Nozzle - your high-performance partner for all professional-grade cleaning and watering needs. This all-metal bodied, robust tool is designed to deliver unparalleled durability and comfort during extended use. It features an adjustable head that allows you to regulate the water flow from a concentrated stream to a gentle mist, perfect for a variety of tasks.



Item #	Desc	UPC	Vendor	CS/UOS	Location
80150344	Power Flow Nozzle	034411114001	840182-1001	8/8	West

Fire Hose Nozzle

Large comfort grip provides a secure hold. All-in-one, fireman-style handle controls water flow & on/off function. Water stream adjusts from jet to gentle rinse.



Item #	Desc	UPC	Vendor	CS/UOS	Location
80150346	Fire Hose Nozzle	034411126417	810022-1001	6/6	West

Select-A-Spray Nozzle

Five-position dial with seven spray patterns: gentle shower, full action (cone, sharp stream, full flow), jet, mist and flood. Hold open clip for continuous spraying. Rust-resistant stainless steel spring. Self-adjusting "duck" packing for lifetime leakproof seal.



Item #	Desc	UPC	Vendor	CS/UOS	Location
80150042	Poly	034411005866	805862-1001	10/10	National
80150041	Zinc	034411005842	805842-1001	10/10	National
80150044	Zinc/Comfort Grip	034411005941	805942-1001	10/10	National



Zinc Coupler (A)

Premium construction for maximum strength and durability. Reusable and leakproof. Non-corroding, high-grade stainless steel screws will not strip when tightened. For use with plastic or rubber hose. Fits all 5/8"-3/4" ID hoses.

Item #	Desc	UPC	Vendor	CS/UOS	Location
80150002	5/8"-3/4" Female	0334411001653	801014-1001	12/12	National

Plastic Hose Mender (B)

Premium construction for maximum strength and durability. Reusable and leakproof. Non-corroding, high-grade stainless steel screws will not strip when tightened. For use with plastic or rubber hose.

Item #	Desc	UPC	Vendor	CS/UOS	Location
80150003	5/8"-3/4"	034411000014	801024-1002	12/12	National
80150011	1/2"	034411000052	805044-1001	12/12	National

Plastic Coupler (C)

Premium nylon construction for maximum strength and durability. Reusable and leakproof. Non-corroding, high-grade stainless steel screws will not strip when tightened. For use with plastic or rubber hose.

Item #	Desc	UPC	Vendor	CS/UOS	Location
80150010	1/2" Female	034411000526	805004-1002	12/12	National
80150012	1/2" Male	034411000519	805054-1002	12/12	National
80150001	5/8"-3/4" Female	034411000120	801004-1002	12/12	National
80150005	5/8"-3/4" Male	034411000113	801134-1002	12/12	National

Compression Mender (D)

Metal body and collar. Ergonomic soft-grip sleeves for ease of use. Durable, reusable and easy to install. Use a mender to repair a hole or crack somewhere in the length of your hose. Just cut out the damaged portion of the hose and splice the ends back together with the mender. No tools required. For 5/8" or 3/4" hoses.

Item #	Desc	UPC	Vendor	CS/UOS	Location
80150755	5/8" - 3/4"	34411002582	805874-1001	10/10	East

Full Flow Water Shut-off Valve (E)

Swiveling nut prevents hose kinks. Non-corroding, impact resistant polymer construction.

Item #	Desc	UPC	Vendor	CS/UOS	Location
97-63252	Plastic	034411205228	800014-1001	6/6	National

Full Flow Double Hose Shutoff "Y" Connector (F)

Non-corroding, high impact polymer construction. Full ball valve prevents leakage.

Item #	Desc	UPC	Vendor	CS/UOS	Location
80150571	Plastic	034411261392	871554-1001	6/6	East

Y Shut-Off Connector (G)

Twin shut-off valves control water flow for two hoses. Cap type valve handles resist breakage. Longer legs prevent hose kinks at faucet. Full ball and retainer rings reduce leakage, even at low pressure.

Item #	Desc	UPC	Vendor	CS/UOS	Location
80150025	Brass	034411007136	813004-1001	6/6	National
80150027	Plastic	034411000175	800174-1002	12/12	East

Metal Dual Shut-Off Valve

Twin shut-off valves control water flow for two hoses. Cap type valve handles resist breakage. Longer legs prevent hose kinks at faucet. Full ball and retainer rings reduce leakage, even at low pressure. No. 17 non-corroding, high impact poly construction. Not recommended for hot water. No. 15 chrome-plated zinc construction. Withstands hot water temperatures to 160 deg F.



Item #	Desc	UPC	Vendor	CS/UOS	Location
80151389	Dual Metal Shutoff	034411000151	800154-1001	6/6	West

2024

Shut-Off Valves

Shut-off valve controls water flow; saves water and time. Cap type valve handle resists breakage.



Item #	Desc	UPC	Vendor	CS/UOS	Location
80150008	Brass	034411007037	803004-1001	6/6	National
80150013	Zinc	034411000038	805084-1001	12/12	West
80150014	Plastic	034411000076	807004-1002	12/12	National

Pro Brass Quick Connector Set

Brass Heavy-duty Quick Connect provides an easy snap-on/snap-off connection to make tasks on the jobsite easier. Simply attach the female connector to the end of your hose and the male connector to your sprinkler, nozzle or second hose.



Item #	Desc	UPC	Vendor	CS/UOS	Location
80150515	Quick Connect	034411029824	840204-1001	12/12	East

Brass Female Quick Hose Coupler Connector

Heavy-duty connectors provide an easy snap-on/snap-off connection to make professional jobs easier. Simply attach the female connector to the end of your hose. Then connect to a heavy duty male quick connector at the end of your watering tool for a tight seal that lasts, use after use. Durable, rust-resistant brass.



Item #	Desc	UPC	Vendor	CS/UOS	Location
80150152	Female	34411029879	809014-1004	12/12	East

Heavy Duty Quick Connector

Heavy-duty Quick Connectors provide an easy snap-on/snap-off connection between your hose and other watering tools. Simply attach the male connector to your sprinkler, nozzle or second hose. Then connect to a heavy duty female quick connector at the end of your hose for a tight seal that lasts.



Item #	Desc	UPC	Vendor	CS/UOS	Location
80150747	Male	34411261330	871514-1001	12/12	East
80150514	Male #400	034411029800	800094-1003	12/12	East
80150748	Female	34411261392	871554-1001	12/12	East

Compression Coupling

Repairs 5/8-inch garden hoses. Ergonomic soft grip sleeves. Durable metal body and collar. No tools required!



Item #	Desc	UPC	Vendor	CS/UOS	Location
80150754	Male	34411002605	805814-1001	10/10	East
80150753	Female	34411002599	800584-1001	10/10	East

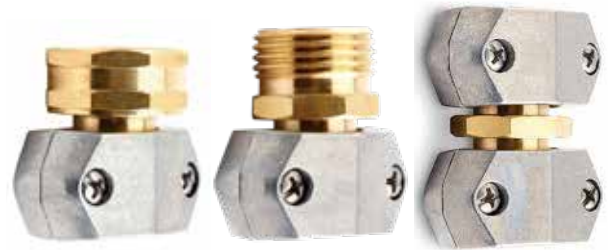

Brass Clamp Coupling

Don't let a crushed coupling take your hose out of commission. Replace damaged female or male hose ends with a heavy-duty brass and zinc coupling that offers superior durability for active job sites. Non-corroding stainless steel screws won't strip when tightened onto your hose. Fits 5/8" & 3/4"

Item #	Desc	UPC	Vendor	CS/UOS	Location
80150517	Female	034411029756	801014-1003	6/6	West
80151326	Male	034411029749	801324-1001	12/12	West
80151324	(5/8" & 3/4")	034411029817	801124-1003	12/12	West



Brass Clamp

Heavy Duty 5/8" Brass Clamp

Item #	Desc	UPC	Vendor	CS/UOS	Location
80151217	Female 5/8"	034411261385	871554-1001	12/12	West
80151215	Male 5/8"	034411261354	871524-1001	12/12	West
80151216	Mender 5/8"	034411261378	871534-1001	12/12	West

Heavy Duty 1-Way Valve

This valve allows you to switch tools with ease all while staying dry. Features all-metal construction with brass threads and is rust-resistant even with frequent use. The durable, easy-grip handle makes it simple to attach to tools. Easily stop the flow of water with its easy-to-use on/off switch.



Item #	Desc	UPC	Vendor	CS/UOS	Location
80150750	1-Way Valve	034411261262	871104-1001	30/30	West

High Flow Brass Dual Outlet Shut-Off Valve

Upgrade your watering setup with the Gilmour Pro High Flow Brass Dual Outlet Shut-Off Valve. This premium dual outlet valve allows you to connect two hoses and control water flow individually with ease. Crafted from high-quality brass, it offers superior durability and corrosion resistance, making it perfect for outdoor use.



Item #	Desc	UPC	Vendor	CS/UOS	Location
80151391	Pro Brass High-flow	034411029794	813024-1002	6/6	West
80151322	High Flow	20034411207134	813024-1001	6/6	West

Brass 4-Way Connector

Four way shut-off valve controls water flow. Extra large handles for easy grip and turn. Easy-on swivel connector prevents hose kinks by allowing hose to turn. Withstands hot water temperatures. Heavy-duty brass construction.



Item #	Desc	UPC	Vendor	CS/UOS	Location
80150575	Brass 4-Way	034411210444	800444-1001	8/8	West

Heavy Duty 2-Way Valve

Efficiently water more of your lawn at once with the heavy duty dual shut-off valve. Featuring all-metal construction with brass threads, This rust-resistant valve stands up to frequent use. The durable, easy-grip handle makes it simple to connect up to two hoses at once.



Item #	Desc	UPC	Vendor	CS/UOS	Location
80150751	2-Way Full flow Heavy Duty	034411261286	871204-1001	24/24	West

Heavy Duty 4-Way Valve

Efficiently water up to four different areas of your lawn or garden at once with the heavy duty quad shut-off valve. Featuring solid metal construction with brass threads, This rust-resistant valve stands up to frequent use. The durable, easy-grip handle makes it simple to connect up to four hoses at once.



Item #	Desc	UPC	Vendor	CS/UOS	Location
80150752	Metal Full flow Shut off Valve Quad	034411261309	871404-1001	6/6	West

Aluminum Shut-Off Valve

More performance from sprinklers and nozzles. Single shut-off valve controls water flow. Extra-large handles for easy grip and turn. Easy-on swivel connector. Withstands hot water temperatures.



Item #	Desc	UPC	Vendor	CS/UOS	Location
80150191	1-Way Aluminum	034411205150	801074-1001	6/6	West

Full Flow Aluminum 2-Way Connector

Durable metal construction stands up to frequent use and allows more flow than standard valves to increase watering efficiency. Connect up to four hoses to water multiple areas of your yard at once.



Item #	Desc	UPC	Vendor	CS/UOS	Location
80150568	2-Way Aluminum	034411205167	800214-1001	6/6	West

Full Flow Aluminum 4-Way Connector

This Gilmour Full Flow metal hose manifold features 4 ports with shutoff valves and 1 side connections to attach additional water hoses. The Full Flow Features allows for 45% more water flow compared to standard fixtures. For multiple watering uses garden hose, this bib hose valve is a great accessory to have on hand.



Item #	Desc	UPC	Vendor	CS/UOS	Location
80150569	4-Way Aluminum	034411205174	800404-1001	6/6	West

Full Flow Poly 4-Way Connector

The Gilmour Quad Full-flow Shut-off Valve is made of impact-resistant, rust-proof polymer to stand up to frequent use, and it provides more flow than standard valves for watering efficiency. An easy-turn knob at each of the four valves allows for quick on/off operation of up to four hoses, and a swivel coupling offers a tight, secure connection to the spigot.



Item #	Desc	UPC	Vendor	CS/UOS	Location
80150572	Full flow Shut off Valve Quad	034411205242	800414-1001	6/6	West

Hose Thread End Cap

These hose caps are for use with 3/4 inch standard hoses. These caps also come with a hose washer. They are made with a durable and rust-proof polymer.



Item #	Desc	UPC	Vendor	CS/UOS	Location
80150581	3/4"	034411000403	800044-1001	12/12	West

Brass Coupler Washers

Quick Connectors link watering tools in one snap; maintain that connection with replacement seals. Durable rubber construction keeps the seal strong, even with frequent use.



Item #	Desc	UPC	Vendor	CS/UOS	Location
80150159	Pro Seals for Brass Quick Connector (3PC)	34411000984	809104-1001	10/10	East

Hose Coupling Filter Washers

Molded-in metal screen. Fits all hose couplings.



Item #	Desc	UPC	Vendor	CS/UOS	Location
80150184	3 pack	034411027103	802004-1001	12/12	National

Rubber Hose Washers

Rubber Hose Seals. Heavy-duty rubber construction. 10 pack.



Item #	Desc	UPC	Vendor	CS/UOS	Location
80150007	5/8"-3/4"	034411025888	801704-1003	12/1	East

Vinyl Hose Washers

Replacement seals for 09QC brass quick connectors. Heavy-duty rubber construction. 10 pack.



Item #	Desc	UPC	Vendor	CS/UOS	Location
80150166	5/8"-3/4"	034411000229	801154-1001	10/1	National

Mechanical Timer

Simply set the amount of time you want your hose or sprinkler to run, switch to "On" and let this timer take care of the rest. Automatically shuts water off when you want it to, no batteries required.



Item #	Desc	UPC	Vendor	CS/UOS	Location
80150473	Timer	034411027981	820054-1001	6/6	National

Electronic Single Outlet Timer

The Gilmour single outlet electronic timer is easy to set and use, no tools needed, and it automatically turns water on and off. Run time is from 1 to 360 minutes (6 Hours), has a rain delay feature and has a large easy to read LCD display. If batteries are low the valve closes and will not open. 2 AA batteries required (not included).



Item #	Desc	UPC	Vendor	CS/UOS	Location
80150474	Timer	034411028001	830134-1001	3/3	National

Electronic Dual Outlet Water Timer

This double outlet Gilmour Electronic Water Timer has an easy-to-set dial and large LCD screen that make programming water start, stop and run time easy, up to 360 minutes. It also has a manual on/off button for additional flexibility. The rain delay feature lets you skip watering when it rains.



Item #	Desc	UPC	Vendor	CS/UOS	Location
80150475	Timer	034411028018	804014-1001	3/3	National

Triple Spike Sprinkler

Provides full or partial coverage. Patented impulse arm saves water by eliminating back and side splash. Diffuser screw allows for easy fingertip adjustment of water stream for even coverage. Water coverage up to 86' diameter at 30 PSI; 112' diameter at 60 PSI.



Item #	Desc	UPC	Vendor	CS/UOS	Location
80150396	Poly	034411028445	822003-1011	6/6	East

Metal Impulse Sprinkler with Adjustable Tripod Base

Metal impulse sprinkler provides full or partial coverage up to 5800 sq. ft., standing up to 56in. tall on a telescoping tripod stand. Color: Gray steel, Adjustable: Yes, Coverage Diameter (ft.): 86, Sprinkler Radius (ft.): 43, Sprayer Type: Impulse, Material: Metal, Sprinkler Coverage (sq. ft.): 5,800



Item#	Desc	UPC	Vendor	CS/UOS	Location
80150441	5,800 sq.ft.	34411011737	819003-1001	1/1	East

Oscillating Sprinkler w/ Turbo Motor

Additional coverage for larger area. Dial easily allows user to set their spray area: left, right, center, full. Provides a gentle spray for delicate plants & re-seeding yd. Swivel coupling makes it easy to attach to hose.



Item #	Desc	UPC	Vendor	CS/UOS	Location
80150768	3000 sq. ft	034411188453	888303-1012	4/4	National

Oscillating Sprinkler

This adjustable length oscillating sprinkler provides the easiest and most familiar approach to watering your lawn. Simply turn the dial to select area to water. This sprinkler features an improved motor for added life and an ABS base for increased durability.



Item #	Desc	UPC	Vendor	CS/UOS	Location
80150731	Plastic 3,600 sq. ft.	034411800133	880013-1011	6/6	National

Ring Base Sprinkler

Works well in low water pressure areas Featuring metal construction, this lawn sprinkler head is durable to provide many years of dependable yard watering. It has a unique design that ensures no water puddling.



Item #	Desc	UPC	Vendor	CS/UOS	Location
80150426	900 sq. ft.	034411030615	830603-1001	12/12	West

Heavy Duty Circular Sprinkler

Versatility of this 8-pattern sprinkler makes watering different shaped areas of your yd. a breeze. Durable construction withstands everyday use & guarantees lasting performance. Designed to operate with low water pressure & is ideal for small lawns or gardens.



Item #	Desc	UPC	Vendor	CS/UOS	Location
80151315	35-feet	034411806036	859563-1014	6/6	West

Pattern Master Circular Sprinkler

Customize your sprinkler's spray and never over-water again. Create your own spray pattern to fit any irregularly shaped area of lawn. Flexible ring customizes spray distance at 12 different points for the ultimate in precise watering.



Item #	Desc	UPC	Vendor	CS/UOS	Location
80150446	86-feet	034411011966	819603-1011	6/6	West

Turbine Rotor Sprinkler

Durable, rustproof polymer sled base. Easily adjusted to cover a full or partial circle. Multi-stream nozzle provides even coverage. Water coverage up to a 4000 sq-ft. (70 ft circle). Sliding deflector for distance control.



Item #	Desc	UPC	Vendor	CS/UOS	Location
80150419	200SPB	034411020029	820133-1001	6/6	West

Metal Square Pattern Rotary Sprinkler

Gilmour Square Pattern Rotary Sprinkler This all metal sprinkler has a weighted base with wheels and 3 sprinkler arms. It will water a square area up to 45 feet by 45 feet. Water coverage up to 2100 square feet.



Item #	Desc	UPC	Vendor	CS/UOS	Location
80150544	45-feet	034411003404	845003-1002	6/6	West

2024

Telescoping High Rise Garden Sprinkler

Adjustable aluminum pole telescopes from 24" to 40". Metal screen filter prevents clogging. Impact resistant, rustproof polymer head and spike. Square pattern coverage up to 50'.



Item #	Desc	UPC	Vendor	CS/UOS	Location
80150048	894	0034411108963	808963-1001	6/6	West



Spot Sprinkler

Targeted watering with superior durability. Gentle, fountain-like spray is ideal for spot-watering small areas without waste. Perfect for treating trouble spots on the lawn and new seed.

Item #	Desc	UPC	Vendor	CS/UOS	Location
80150430	A Circle Water Pattern	034411087633	808763-1001	10/10	West
80150428	B Square Water Pattern	034411087619	887613-1001	10/10	West
80150429	C Rectangle Spray Pattern	034411087626	887603-1001	10/10	West

Medium Duty Rectangular Sprinkler

Through innovative design & technology Gilmour created a sprinkler that's easy to use, simple to adjust & intuitively customizes to fit your lawn. Gilmour clever on-off flow control switch requires just one simple turn to move from on to off & every pt. In between. That means no more getting soaked when you want to move your sprinkler.



Item #	Desc	UPC	Vendor	CS/UOS	Location
80150734		034411260531	883023-1011	6/6	West

Heavy Duty Rectangular Metal Whirling Vane Sprinkler

An all metal sprinkler that will gently water an area up to 32 feet by 32 feet. Up to 1,024 sq. ft. coverage. Durable metal construction. Provides a gentle spray for delicate plants and re-seeding yards. Ideal for small areas.



Item #	Desc	UPC	Vendor	CS/UOS	Location
80151228	Sprinkler	034411008324	808323-1002	6/6	West

Kink Protector

Prevents kinking at faucet. Coiled spring faucet extension with solid brass couplings. Protects hose. Allows hose to bend at sharp angle and maintain even water flow.



Item #	Desc	UPC	Vendor	CS/UOS	Location
80150526	Kink Protector	034411010822	810054-1001	12/12	West

Aluminum Bubbler Sprinkler

The Gilmour Aluminum Bubbler Sprinkler is designed with precision in mind, ensuring that water is distributed exactly where it's needed most. Crafted from high-quality aluminum, this sprinkler is built to withstand the test of time. Its corrosion-resistant properties make it ideal.



Item #	Desc	UPC	Vendor	CS/UOS	Location
80150427	Aluminum Bubbler	034411031575	831503-1001	12/12	West



Leader in Horticultural Containers

Essential Watering Can

Lightweight plastic indoor watering can with large opening for easy filling. Fun and fashionable colors so it can be displayed as part of your decor or hidden away in a cupboard.



Item #	Desc	UPC	Vendor	CS/UOS	Location
80282877	1/2 gal Watermelon	770932844897	RZ.WCHG0FD7	24/24	National





Leader in Horticultural Containers

1-Quart Green Watering Can

Special features include an ergonomic handle and balanced design to make this everyday gardening tool versatile, easy-to-use, and durable. Large, offset opening is easy-to-fill from spigot or sink. Long, drip-resistant spout. Molded-in water-level indicators to make it easy to determine proper water-to-fertilizer ratio.



Item #	Desc	UPC	Vendor	CS/UOS	Location
80280829	1 qt	032903075588	RZ.WC1Q0B91	6/6	National

1-Gallon Green Watering Can

Fill opening is to the side of the can, allowing for easy filling from sink or spigot. Long, drip-resistant spout. Molded in water level indicators on the side, with volume measured in both gallons and liters, useful in determining proper water-to-fertilizer ratio.



Item #	Desc	UPC	Vendor	CS/UOS	Location
80290075	1 gal	032903728866	RZ.WC1G0B91	6/6	National

2-Gallon Green Watering Can

Premium watering can crafted for effortless filling from a spigot or sink to assist you in helping your plants and flowers thrive. Offset design with a rosette allows you to pour without the worry of spilling from the watering can mouth.



Item #	Desc	UPC	Vendor	CS/UOS	Location
80280830	2 gal	032903725186	RZ.WC2G0B91	8/8	National

2 Gallon Green Standard Watering Can

The 2 Gallon Green Standard Watering Can has an ergonomic handle with a balanced design that is easy-to-use and durable. The large offset opening is easy to fill from the spigot or sink. It has a long, drip-resistant spout with molded-in water level indicators that make it easy to determine proper water-to-fertilizer ratio.



Item #	Desc	UPC	Vendor	CS/UOS	Location
80282486	2 gal.	770932840899	RZ.WC2G3B66	10/10	National



Turbo Rotary Sprinkler with Tripod

Rotary sprinkler with 43" adjustable tripod base, waters up to 80' in diameter. Adjustable head with six patterns. Durable turbo motor that features quiet operation for early morning watering.



Item #	Desc	UPC	Vendor	CS/UOS	Location
81780059	Rotary Sprinkler Tripod	042206157522	15752	6/6	National

Metal Pulsating Sprinkler w/ Tripod

Take watering to new heights with the Metal Pulsating Sprinkler with Tripod. Cover an area up to 85' in diameter, great for watering large size lawns and gardens. The sturdy tripod base extends up to 48" high, to water from above...providing a more natural, rain like spray. The all metal construction is durable enough to last through seasons of use.



Item #	Desc	UPC	Vendor	CS/UOS	Location
81780039	Pulsating Sprinkler Tripod	042206096203	9620-8	4/4	National

TURBOTEK™ Oscillating Sprinkler

Melnor® TurboTek™ Turbo Oscillating Sprinklers deliver the smoothest operation for even, gentle coverage. Covers up to 3,200 sq. ft.



Item #	Desc	UPC	Vendor	CS/UOS	Location
81780026	3,200 sq. ft.	042206302618	30261	6/6	National

Oscillating Sprinkler

The gentle shower of the EasyGrow™ Max Oscillating Sprinkler is perfectly suited for newly seeded gardens or established yards. Covers up to 3,400 sq. ft.



Item #	Desc	UPC	Vendor	CS/UOS	Location
81780030	3,400 sq. ft.	042206223005	22300	6/6	National



XT Metal 7-Pattern Nozzle

Heavy duty, metal construction. Offers seven spray patterns for all your watering needs. Slip-resistant rubberized grip, trigger and head.



Item #	Desc	UPC	Vendor	CS/UOS	Location
81780089	Rear Trigger	042206302014	XT201	10/10	National

RelaxGrip® 8-Pattern Pivoting Wand

RelaxGrip® handles are designed to provide a more comfortable grip, so you can get more done without putting strain on your wrists and hands. An easy to operate thumb control eliminates the need to squeeze or lock in place. The 16" wand and pivoting head make it easy to water hanging baskets or hard to reach areas. Multiple spray patterns give you the flexibility to rinse off the car or shower the vegetable garden with just one tool.



Item #	Desc	UPC	Vendor	CS/UOS	Location
81780134	16" wand	042206286338	R8633	12/12	National

RelaxGrip® 8-Pattern Nozzle

Designed to provide the most comfortable grip, so you can get your gardening done with ease. Multiple patterns let you water a colorful array of petunias with a gentle shower or clear off the patio with a full spray. Designed to be light-weight yet durable to last for years.



Item #	Desc	UPC	Vendor	CS/UOS	Location
81780081	Rear Trigger	042206155603	R201	10/10	National
81780083	Thumb Control	042206156921	R301	10/10	National

Flat Soaker Hose

Waters with minimal run-off. Easier to use than standard soaker hoses. Easier to bend and store. Rolls up tight to store in a small space.



Item #	Desc	UPC	Vendor	CS/UOS	Location
81780232	50'	042206860507	86050-12	12/12	National
81780231	75'	042206860750	86075-12	12/12	East

Pulsating Sprinkler On Metal Spike

Features adjustable control that allows you to select watering distance and coverage angle for your specific needs. Covers up to an 85ft diameter.



Item #	Desc	UPC	Vendor	CS/UOS	Location
81780044	85ft coverage	042206955012	9550C	12/12	National

Sunrise™ Once-a-Day Water Timer

The Sunrise™ Once-a-Day timer takes care of watering the plants for you. Absolutely no programming. The sun starts the watering process and automatically turns off when it's done. Simply set the amount of time you want to water and SunRise™ does the rest.



Item #	Desc	UPC	Vendor	CS/UOS	Location
81780013	Timer	042206230126	13012	4/4	National



Hose Coupling Connectors

Item #	Desc	UPC	Vendor	CS/UOS	Location
81780165	A 5/8" or 3/4" Mid-Hose	042206145062	02MC	10/10	National
81780168	B 5/8" or 3/4" Female	042206145031	2FMC	10/10	National
81780169	C 5/8" or 3/4" Male	042206145048	2MMC	10/10	National

HiFlo™ 4-Way Hose Valve

Large size allows greater water flow and large knobs ensure easy operation. Durable ABS construction.



Item #	Desc	UPC	Vendor	CS/UOS	Location
81780242	4 Way	042206003379	337-6	6/6	National

Hose Washers

Replacement for worn out hose washers. Fits all sizes. 12 per card.



Item #	Desc	UPC	Vendor	CS/UOS	Location
81780265	12 pk	042206143280	200C	30/30	National

Hose Repair Metal Clinch Couplers



Item #	Desc	UPC	Vendor	CS/UOS	Location
81780172	3/4" Female	042206142610	20Z3/4	10/10	National

Brass Hose Repair w/ Clamp



Item #	Desc	UPC	Vendor	CS/UOS	Location
81780182	5/8"	042206153678	15367	10/10	National

Brass Hose Repair Set



Item #	Desc	UPC	Vendor	CS/UOS	Location
81780184	5/8" Set	042206153708	15370	10/10	National



2-Way Hose Connectors w/ Shut-Off Valves

Item #	Desc	UPC	Vendor	CS/UOS	Location
81780250	A Metal	042206090003	9000	10/10	National
81780251	B Chrome	042206142009	312S	10/10	National
81780252	C Plastic	042206142214	313S	10/10	National

Mossify squirt - Liquid Squirter

These Mossify squirt's are a handy alternative if you are looking to get water in very tight spaces. You can fill it up with anything that carries the same properties as water does. 500ml



Item #	Desc	UPC	Vendor	CS/UOS	Location
82370053	Clear	660111996946	SQRT-CL-0001	12/12	National
82370054	Pink	660111996953	SQRT-PI-0001	12/12	National

The Mossify mistr™ - Electric Mister

Increase humidity for your plants using the fully rechargeable Mossify Mistr. With one click, you will have a continuous fine mist to provide extra humidity to all of your tropical foliage. With a capacity of 750ml, this sleek and stylish mister will have your plants thanking you for the additional moisture in the air. Comes with USB charger



Item #	Desc	UPC	Vendor	CS/UOS	Location
82370007	Mister	716252512283	MISTR-0001	12/12	National





Gnome Watering Can

"Gnute the Gnome" Novelty's gnome watering can stands tall as a sentry over the garden. This 1.5-gallon can is sure to be a classic piece of garden art. 100% recyclable.



Item #	Desc	UPC	Vendor	CS/UOS	Location
80250488	1.5 gal.	026978309013	30901	10/10	National

Indoor Watering Can

This watering can is designed for indoor use. Made of recyclable, impact resistant plastic. Watering can has a flower design indentation on the side for added styling. Features a curved loop handle and long stem spout for comfort and ease of use.



Item #	Desc	UPC	Vendor	CS/UOS	Location
80250622	Red 1 gal.	026978307057	30705	6/6	National
80250115	Sky 1 gal.	026978307026	30702	6/6	National



Outdoor Watering Cans

Comfortable handle for outdoor use.

Item #	Desc	UPC	Vendor	CS/UOS	Location
80250617	2 gal Sky Blue	026978304025	30402	12/12	National
80250322	2 gal Bright Blue	026978304094	30409	12/12	National
80250827	2 gal Green	026978304131	30413	12/12	National
80250826	2 gal Red	026978304117	30411	12/12	National

Classic Gardener's Outdoor Watering Can

2-gallon capacity classic watering can. Features a twist off white nozzle.



Item #	Desc	UPC	Vendor	CS/UOS	Location
80250318	Green 2 gal.	026978303011	30301	12/12	National

Indoor Watering Cans

This watering can is designed for indoor use. Made using recyclable, impact resistant plastic. Watering can has a flower design indentation on the side for added styling. Features a curved loop handle and long stem spout for comfort and ease of use.



Item #	Desc	UPC	Vendor	CS/UOS	Location
802509331	Green 1/2 gal.	026978306012	30601	6/6	National
80250114	Pearl 1/2 gal.	026978306029	30602	6/6	National
80250621	Red 1/2 gal.	026978306050	30605	6/6	National

Babs - Pig Watering Can

Babs, Novelty's affable pig watering can, holds 1 3/4 gal. of water. Kids and pig lovers alike adore this fine swine watering vessel.



Item #	Desc	UPC	Vendor	CS/UOS	Location
80250029	Pink 1 3/4 gal.	026978305008	30500	10/10	National

Squirt - Fish Watering Can

The fish are flying at Novelty. Making a big splash at the pool, beach or in the garden, Squirt, watering can, appeals to "kids" of all ages. Keeping our earth and waters eco-friendly, Novelty watering cans are recyclable.



Item #	Desc	UPC	Vendor	CS/UOS	Location
80250030	Orange 3/4 gal	026978308061	30806	6/6	National

Lucky Duck Watering Can

With a comfortable handle and easy pouring features, this one gallon darling is a winner.



Item #	Desc	UPC	Vendor	CS/UOS	Location
80250486	Yellow 1 gal.	026978301048	30104	6/6	National

2024

Orbit®



Assorted Colors



8-Pattern Plastic Nozzle (A)

Hose nozzle with 8 patterns. Ergonomically- designed thumb control. Assorted case pack 2ea Blue, Green, and Purple

Item #	Desc	UPC	Vendor	CS/UOS	Location
80340588	Nozzle	034613710872	71087BL	6/6	East

10-Pattern Plastic Nozzle (B)

Locking clip allows continuous spray. Ergonomic grip. Assorted case pack 2ea Blue, Green, and Purple

Item #	Desc	UPC	Vendor	CS/UOS	Location
80340213	10 Pattern Nozzle	034613707407	70740BL	6/6	East

9-Pattern Water Wand (C)

9-Pattern Wand has 9 selectable patterns: Mist, Flat, Jet, Vertical, Sunrise, Full, Shower, Cone and Soaker. Insulated comfort grip. On/Off switch. 3 year warranty. Comes in 3 colors: purple, green and blue.

Item #	Desc	UPC	Vendor	CS/UOS	Location
80340210	30" Water Wand	034613707377	70737BL	12/12	East

Bloom Water Wands (D)

Shower head for gentle watering. Flow-control allows you to adjust flow without going back to faucet. Cushion grip with trigger. Comes in 3 colors: purple, green and blue.

Item #	Desc	UPC	Vendor	CS/UOS	Location
80340209	18"	034613707360	70736BL	12/12	East

Sunflower Sprinkler

Easily stakes into the ground. Covers approximately 9.8ft-13ft. Assorted colors of purple, blue, and green.



Item #	Desc	UPC	Vendor	CS/UOS	Location
80340715	Spinkler	34613709302	70930BL	12/12	East

PANACEA®

Vintage Galvanized Watering Can

Give plants the nourishment they need with antique-chic flair with this watering can that boasts a vintage design.



Item #	Desc	UPC	Vendor	CS/UOS	Location
80161140	1 gal	093432848821	84882	4/4	National
80161137	2 gal	093432848807	84880	4/4	National



.75 Gallon Garden Quotes Watering Cans

Watering cans in 4 assorted colors.

Item #	Desc	UPC	Vendor	CS/UOS	Location
80161144	.75 gal	093432848913	84891	4/4	National



Basic Heavy Duty Steel Hose Hanger (A)

Item #	Desc	UPC	Vendor	CS/UOS	Location
80161597	Black	093432840757	84075	6/6	National
80160265	Green	093432894750	89475	6/6	National

Scroll Hose Hanger (B)

Item #	Desc	UPC	Vendor	CS/UOS	Location
80160259	Scroll	093432840092	84009	4/4	National

Gothic Steel Hose Hanger (C)

Item #	Desc	UPC	Vendor	CS/UOS	Location
80161598	Gothic	093432844076	84076	6/6	National

Star Hose Hanger (D)

Item #	Desc	UPC	Vendor	CS/UOS	Location
80160144	Star	093432840153	84015	4/4	National

Element Earth Quencher Vinyl Sprinkler

Ideal for watering lawns and narrow garden areas. Place stripes up for sprinkling or stripes down for soaking gardens or flower beds. Features 6 perforations per foot which create a wall of soaking mist. Lead free, drinking water safe, and eco-safe for gardening. Oversized, heavy-duty couplings. Capped male end make daisy chaining sprinklers simple, provides easy draining and storage. Compact and easy to store.



Item #	Desc	UPC	Vendor	CS/UOS	Location
82160081	25' Soaker/Sprinkler Hose	078627991261	CELTECV025	10/10	East
82160082	50' Soaker/Sprinkler Hose	078627991278	CELTECV050	10/10	East

Soft & Supple Hose

The Classic, Swan Soft and Supple 5/8 in. hose features lead-free, crush-proof aluminum couplings that can withstand being trampled or run over by garden equipment. The abrasion-resistant cover keeps the hose in top shape year after year and, with a limited lifetime warranty, you can be sure that you'll be using this garden hose over the long term. The 100 ft. is perfect for a standard yard or landscaping project, giving you plenty of reach without sacrificing water volume.



Item #	Desc	UPC	Vendor	CS/UOS	Location
82160023	5/8" X 25'	078627583312	CSNSS58025	5/5	East
82160024	5/8" X 50'	078627583329	CSNSS58050	5/5	East
82160025	5/8" X 75'	078627583336	CSNSS58075	3/3	East
82160026	5/8" X 100'	078627583343	CSNSS58100	2/2	East

2024

Element Contractor/Farm® Hose

For those who need to supply a high volume of water over a large area such as a farm, construction site or stretch of landscape, Swan's Element Contractor/FARM® hose has several features that make it the ideal contractor farm hose for both construction and agricultural needs, from cleaning debris off a worksite to watering trees.



Item #	Desc	UPC	Vendor	CS/UOS	Location
82160041	3/4" X 50'	078627348720	CELCF34050	5/5	East
82160042	3/4" X 75'	078627348737	CELCF34075	3/3	East
82160043	3/4" X 100'	078627348744	CELCF34100	2/2	East
82160044	5/8" X 50'	078627588720	CELCF58050	5/5	East
82160045	5/8" X 75'	078627588737	CELCF58075	3/3	East
82160046	5/8" X 100'	078627588744	CELCF58100	3/3	East

MAXLite® Premium Hose

Swan's MAXLite® Premium Rubber+® black hose offers a major advancement in rubber hose technology. It features an exclusive rubber formula that makes it twice as strong and 40 percent lighter than standard rubber hoses.



Item #	Desc	UPC	Vendor	CS/UOS	Location
82160068	5/8" X 50'	078627036054	CELSGC58050	4/4	East
82160070	5/8" X 100'	078627036078	CELSGC58100	2/2	East

WeatherFLEX® Hose

Swan's WeatherFLEX® all-weather hose is a medium-duty garden hose perfect for everyday watering tasks such as watering the garden, watering the lawn and general cleanup. With a 5/8-inch inside diameter and strong 300+ PSI burst strength, the WeatherFLEX® water hose delivers just the right amount of water at the right speed for all of your outdoor needs.



Item #	Desc	UPC	Vendor	CS/UOS	Location
82160028	5/8" X 25'	078627582216	CSNWF58050	5/5	East
82160029	5/8" X 50'	078627582223	CSNWF58050	5/5	East
82160030	5/8" X 75'	078627582230	CSNWF58075	3/3	East
82160031	5/8" X 100'	078627582247	CSNWF58100	3/3	East

XFlex Hose

From the innovation experts at Swan comes the XFlex, a truly revolutionary garden hose that combines all the most sought-after features in garden hose functionality. From lightweight and long-lasting to kink-resistant, it's the perfect water hose for the landscaper and active home gardener. Patent pending X-FLO kink proof technology makes hose impossible to kink X-FLO fiber prevents the stoppage of water flow and allows water pressure to open up any folds or kinks. Ultra lightweight, rugged performance. Flexible at all temps. Ergonomic female and male grips make attachment quick and easy.



Item #	Desc	UPC	Vendor	CS/UOS	Location
82160117	1/2" X 25'	078627043731	CSNXF12050	12/12	East
82160118	1/2" X 50'	078627043748	CSNXF12100	6/6	East
82160033	5/8" X 50'	078627043601	CSNXF58050	6/6	East
82160119	1/2" X 100'	078627043847	CSNXF58025	4/4	East

Never Dry Plant Pal Mini - Single

Great for keeping your potted plants watered while on vacation. No more coming home to dried out plants! Clay base releases water when the soil needs it. Waters your plants by diffusion.



Item #	Desc	UPC	Vendor	CS/UOS	Location
81510145	Mini Single Clear Kit	038858135742	6713-24-00	24/24	National

Never Dry Plant Pal Mini

Great for keeping your potted plants watered while on vacation. No more coming home to dried out plants!

Clay base releases water when the soil needs it. Comes in assorted colors green, blue, and clear



Item #	Desc	UPC	Vendor	CS/UOS	Location
81510146	MINI Asst Plant Pal Kit	038858135759	6717-12-769	12/12	National

Plant Mister

Care for your plants in style. This mister gently waters your succulents and air plants. Glass bulb base with brass nozzle and mister components. Both decorative and functional, these plant misters make the perfect add-on to any terrarium gift. Assortment includes one each, purple, amber, seaglass, vintage green, and two crystal clear.



Item #	Desc	UPC	Vendor	CS/UOS	Location
81510154	Amber	038858135858	9685-06-423	6/6	National
81510153	Clear	038858135841	6/9/9685	6/6	National
81510155	Sea Glass	038858135865	9685-06-579	6/6	National
81510173	Green	038858135872	9685-06-426	6/6	National
81510172	Purple	038858135889	9685-06-425	6/6	National
81510300	Assorted	038858108166	9685-06-4502	6/6	National



Never Dry Plant Pal

Great for keeping your potted plants watered while on vacation. No more coming home to dried out plants! Ceramic design releases water slowly. Comes in assorted colors green, blue, and clear

Item #	Desc	UPC	Vendor	CS/UOS	Location
81510147	Asst Plant Pal Kit	038858135766	6718-12-769	12/12	National



Elephant Watering Can

Stands about 8" tall, 15" long and holds 2 quarts--the perfect size for your window box flowers or house plants.



Item #	Desc	UPC	Vendor	CS/UOS	Location
81320029	Grey	078304631824	63182	12/12	East



Watering Can

Features a replaceable screw on sprinkler head and floral design on the sides. Can stands about 13" tall, 17" long and holds 2 gallons.

Item #	Desc	UPC	Vendor	CS/UOS	Location
81320019	Caribbean Blue	078304630667	63066	12/12	East
81320018	Hunter Green	078304630650	63065	12/12	East
81320021	Sage Green	078304630681	63068	12/12	East
81320092	Purple	078304630711	63071	12/12	East

Kids Watering Can

Kids can water plants like grown ups with these brightly colored watering cans. 16 piece assorted case pack, four of each color, pink, green, blue, and orange. 9"W x 3.5"D x 6"H



Item #	Desc	UPC	Vendor	CS/UOS	Location
81550084	Kids Metal Watering Cans	017783050702	5070	16/16	National

Indoor Watering Can

This 1/2 gallon, metal, indoor watering can comes in an assortment that includes pink, yellow, blue, purple and green. For indoor use only.



Item #	Desc	UPC	Vendor	CS/UOS	Location
81730326	Assorted	745487082803	8280	10/10	East

2024



Kids Pails

Children can easily make sand castles, carry water, and toys. 16 piece assorted case pack, four of each color, pink, green, blue, and orange. 7.25"W x 7.25"D x 6"H

Item #	Desc	UPC	Vendor	CS/UOS	Location
81550085	Kids Metal Pails	017783050801	5080	16/16	National



Watering Can with Copper Accents

This striking design combines a sturdy galvanized steel body with copper accents on both handles, rosette cap, and bottom band to create a decorative and highly functional watering can. Heavy duty galvanized steel construction for long life and rust resistance. Threaded removable rosette-diffuser creates a gentle shower of water to leave mulch and soil undisturbed; perfect for young seedlings. Angled neck spout reaches well inside your foliage. Suitable for both indoor and outdoor use.

Item #	Desc	UPC	Vendor	CS/UOS	Location
81730035	1gal Steel/Copper	745487983261	8326	6/6	East
81730036	1gal Green/Copper	745487983278	8327	6/6	East
81730037	1.9gal Steel/Copper	745487083305	8330	4/4	East



1 pt. Mini Plastic Watering Can

Kids can easily water plants. Great for indoor plants too. 10"W x 2.75"D x 5.5"H

Item #	Desc	UPC	Vendor	CS/UOS	Location
81550539	1pt. Green	400278950017	5001G	15/15	National
81550538	1pt. Blue	400278950015	5001B	15/15	National
81552204	1pt. Pink	4027371121246	5001P	15/15	National



Galvanized Watering Can

1 gallon capacity. Galvanized watering can with powder coated finish.

Item #	Desc	UPC	Vendor	CS/UOS	Location
81730341	Heritage Blue	814567025372	8350	4/4	East
81730342	Sunshine Yellow	814567025389	8351	4/4	East
81730343	Heritage Scarlet	814567025396	8352	4/4	East
81730344	Heritage Plum	814567025402	8353	4/4	East

PLANT CARE & FOOD



CHECK OUT OUR CLEARANCE ITEMS!

DROP SHIP VENDORS

Espoma (cased goods):

Minimum of 300 units
\$75 stop charge for LTL shipments
\$250 liftgate fee (8 pallets or less)



Griffin Greenhouse Retail WAREHOUSE Shipping Map

We are now shipping nationwide!

NATIONAL



2024

Refer to location key:

National items are stocked nationally
 Select items are sold East or West only; no exceptions

8" Kaleidoscope Planter

Premium plastic modular planter can be displayed individually each planter has a removable saucer ideal for succulents or shallow rooted planted.

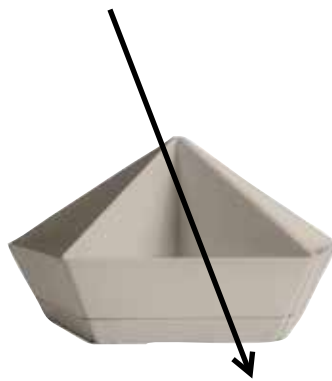

Item #	Desc	UPC	Vendor	CS/UOS	Location
80282643	Vanilla Bisque	770932844170	KDP08000A58	6/6	National

Where is the pricing?

1. Scan QR code on Chapter Pages to see pricing on Griffins.com
2. Contact your Griffin Sales Representative
3. Call into Griffin Customer Service 800.888.0054



ARBER

Plant Food Concentrate 3-2-1

Certified for Organic Gardening by CDFA/OIM. Improves your plant's uptake of essential nutrients, strengthening from root to shoot. Nutritional supplement for indoor gardening and houseplants.



Item #	Desc	UPC	Vendor	CS/UOS	Location
82200009	8 oz	850025915212	2-411762-2	6/6	East
82200004	16 oz	850025915021	2-411712-1	6/6	East



Liquid Iron Complex

Promotes vigorous growth and dark green color. Corrects iron deficiency. Use on turf, flowers, shrubs, trees, etc. Contains iron and sulfur. Chelated.



Item #	Desc	UPC	Vendor	CS/UOS	Location
80100001	32 oz. Con.	037321002994	299	12/12	National

Root-N-Grow 4-10-3

Fertilizer with IBA growth hormone Stimulates early and strong root formation. Promotes greener, more vigorous plants. Weatherproof packaging permits outside merchandising.



Item #	Desc	UPC	Vendor	CS/UOS	Location
80100228	Con. pt.	37321004110	411	12/12	National
80100404	Con. qt.	37321004127	412	12/12	National



Flowers & Vegetables 13-13-13 (A)

Excellent for all flowering shrubs, trees, landscape plants, foliage, houseplants, ferns, palms, grasses and herbs. Contains balanced rates of NPK + micro-nutrients to aid in the establishment of roots, strong stems and branches, greener foliage and more blooms. Feeds continuously for up to 9 months.

Item #	Desc	UPC	Vendor	CS/UOS	Location
81830051	1 lb.	785344059128	82080	12/12	East

All Purpose 18-6-8 (B)

Excellent for all flowering shrubs, trees, landscape plants, foliage, houseplants, ferns, palms, grasses and herbs. Contains balanced rates of NPK + micro-nutrients to aid in the establishment of roots, strong stems and branches, greener foliage and more blooms. Feeds continuously for up to 9 months.

Item #	Desc	UPC	Vendor	CS/UOS	Location
81830049	1 lb.	785344059517	82060	12/12	East

All Purpose Select 15-5-9 (C)



Excellent for all flowering shrubs, trees, landscape plants, foliage, houseplants, ferns, palms, grasses and herbs. Balanced rates of NPK plus micros. Also contains calcium for growth and structure. Feeds continuously up to 9 months. Contains necessary micronutrients. Environmentally sustainable. Feeds continuously for up to 9 months.

Item #	Desc	UPC	Vendor	CS/UOS	Location
81830045	2 lb.	785344887769	82020	12/12	East

Cactus & Succulent 18-6-8 (D)

Dynamite Cactus & Succulent Food has been specially formulated to feed all succulents and cacti. Contains not only NPK but a full range of micro-nutrients to help your cacti & succulents thrive. Can be used in ground or container plantings. Feeds continuously for up to 6 months.

Item #	Desc	UPC	Vendor	CS/UOS	Location
81830055	1 lb.	79925082170	82170	12/12	East

Mater Magic® 8-5-5 (E)



Dynamite Mater Magic® is the easy way to grow bigger, juicier tomatoes. Mater Magic can be used on plants in-ground or in containers with amazing results.

Item #	Desc	UPC	Vendor	CS/UOS	Location
81830047	.675 lb.	785344059104	82030	8/8	East



We collect food waste from our local communities and recycle it into plant food. The Project was developed to provide job skills training and opportunities for individuals with disabilities, as well as repurposing food waste into a usable product.

Desc	Size	Item #	CS/UOS	Location
5-0-6 All Purpose	2 lb	82190003	12/12	East
4-0-4 Hydrangea	2 lb	82190001	12/12	East
5-0-6 Tomato	2 lb	82190002	12/12	East

*Available for sale in CT, MA, ME, NH, NY, RI, & VT



Coast of Maine

Squid Concentrate All Natural Plant Food for Indoor Plants (2-3-0)

A truly remarkable fertilizer made entirely of squid. Intended to promote budding and blooming, this concentrated fertilizer also enriches the soil with plant-ready minerals, giving your plants a significant boost! Great for greenhouse and hydroponic systems and both indoor and outdoor applications.



Item #	Desc	UPC	Vendor	CS/UOS	Location
81600034	1 quart	609853000764	SQ7000	12/12	East



Stonington Blend™ Organic Plant Food with Lobster, Kelp & Worm Castings (5-2-4)

Made with lobster, crab, fish and kelp meal plus worm castings and other important natural ingredients, this exceptional fertilizer will super charge the biological activity of your soil, giving all your plants a significant boost. It is also high in calcium (4%) and a range of macro and micronutrients to help improve plant vigor! OMRI Listed.

Item #	Desc	UPC	Vendor	CS/UOS	Location
81600015	4 lb.	609853000618	SP6000	8/8	East

Fish Bone Meal Organic Plant Food for Buds & Blooms - (5-13-0) with 1% Calcium

An exceptional organic fertilizer ideal for budding and blooming plants. Made from dehydrated fish bones, it is an excellent natural source of phosphorus, calcium, nitrogen, essential minerals and trace elements. Available in 3lb bags. OMRI Listed.

Item #	Desc	UPC	Vendor	CS/UOS	Location
81600016	3 lb.	609853000726	FM6000	8/8	East

Lobster Meal Organic Plant Food for Greening & Leafing (6-2-0) with 8% Calcium

Made entirely of chitin-rich lobster and crab shell, this is the ideal organic fertilizer for outdoor containers, vegetable, herb and flower gardens. Natural nitrogen and calcium help promote strong stem growth, healthy green foliage, and vigorous roots. Available in 4lb bags. OMRI Listed.

Item #	Desc	UPC	Vendor	CS/UOS	Location
81600017	4 lb.	609853000696	LM6000	8/8	East

Kelp Meal All Purpose Organic Plant Food (1-0-1) with 1% Calcium

100% dehydrated Norwegian Kelp (common seaweed), a source of trace quantities of macro and micro-nutrients that will help promote healthier plants and improve crop yields. Use around trees and shrubs, on lawns and in garden beds or to top-dress containers.

Item #	Desc	UPC	Vendor	CS/UOS	Location
81600018	4 lb.	609853000702	KM6000	8/8	East



BLENDS



Acid Mix 4-3-6

Acid Mix 4-3-6 is a fertilizer blended for plants that thrive in a low pH soil like blueberries and raspberries, rhododendrons, azaleas, hydrangeas, evergreen trees and shrubs. To encourage lush flowers and fruit, apply DTE Acid Mix 4-3-6 in early spring for vegetative growth and again when blooms appear. Fall applications promote root growth and boost resistance to extreme winter temperatures.

Item #	Desc	UPC	Vendor	CS/UOS	Location
82390110	1 lb	714360178032	17803	12/12	National
82390052	5 lb	714360078240	07824	6/6	National
82390100	15 lb	714360158249	15824	1/1	National
82390035	25 lb	714360032273	03227	1/1	National

Citrus Mix 6-3-3



Citrus trees are a particularly satisfying compliment to the home garden with their vibrant fruits, fragrant blossoms and appealing glossy foliage. Down To Earth's Citrus Mix 6-3-3 is specially formulated with primary and secondary plant nutrients plus selected micronutrients that promote lush new growth, abundant green foliage and bountiful blossoms and fruit.

Item #	Desc	UPC	Vendor	CS/UOS	Location
82390117	1 lb	714360178636	17863	12/12	National
82390067	5 lb.	714360078639	07863	6/6	National

2024

All Purpose 4-6-2



All Purpose 4-6-2 mix is ideal for all types of transplants. A gentle, non-burning fertilizer made for vegetables, herbs, flowers and container plants, it is formulated with top-quality organic ingredients and designed to deliver a steady supply of essential nutrients to your plants while enhancing soil fertility and microbial activity naturally.

Item #	Desc	UPC	Vendor	CS/UOS	Location
82390108	1 lb	714360178018	17801	12/12	National
82390048	5 lb	714360078066	07806	6/6	National
82390098	15 lb	714360158065	15806	1/1	National
82390015	25 lb	714360019427	01942	1/1	National

Vegetable Garden 4-4-4



Vegetable Garden 4-4-4 is full of powerful plant nutrition to help your garden grow! Its all-purpose formulation provides a perfect start for your sprightly spring veggies, gives your summer tomatoes super-powers and is fantastic for growing your favorite fragrant herbs. Vegetable Garden's broad nutrient profile is ideal for use throughout the growing season. Grow and Eat Your Veggies!

Item #	Desc	UPC	Vendor	CS/UOS	Location
82390116	1 lb	714360178544	17854	12/12	National
82390063	5 lb	714360078547	07854	6/6	National
82390003	25 lb	714360012541	01254	1/1	National

Starter Mix 3-3-3



Starter Mix 3-3-3, our starter and transplant formula, is the perfect way to get your delicate young starts and new seedlings in the ground and ready to thrive. In addition to essential primary and secondary plant nutrients we've added a beneficial mix of endomycorrhizal fungi to ensure successful planting, expansive root development and vigorous early growth. Use Starter Mix throughout the growing season when transplanting, preparing seed starting soil mixes and for container grown flowers, herbs and vegetables.

Item #	Desc	UPC	Vendor	CS/UOS	Location
82390115	1 lb	714360178360	17836	12/12	National
82390057	5 lb	714360078363	07836	6/6	National

Cactus & Succulent 2-4-8

Cactus & Succulent is a blended fertilizer specially designed to support the keystone plants commonly found in arid climate gardens and water-wise xeriscapes. These fascinating specimens are adapted to withstand challenging environmental stresses and utilize diverse tactics to manage water storage efficiently. This robust blend of natural and organic ingredients will supply succulents of all types, including cactuses and agaves, with the nutritional backbone to keep them growing strong and producing beautiful blooms. At the same time, improving soil conditions and encouraging their extensive root systems can help maintain fabulous conservation focused gardens filled with striking cactuses and succulents.



Item #	Desc	UPC	Vendor	CS/UOS	Location
82390119	1 lb	714360178780	17878	12/12	National

Bio-Live® 5-4-2



Bio-Live 5-4-2 is a rich, organic fertilizer featuring a unique blend of premium marine byproducts infused with a diverse mixture of beneficial microorganisms that improve resource utilization and enhance nutrient uptake. Select mycorrhizal fungi and bacterial species rapidly colonize the rhizosphere and surrounding soil.

Item #	Desc	UPC	Vendor	CS/UOS	Location
82390055	5 lb	714360078288	07828	6/6	National
82390011	25 lb	714360019243	01924	1/1	National



Fruit Tree 6-2-4



Fruit Tree is designed for the delicious and nutritious tree fruits now popular in many backyard gardens. DTE Fruit Tree fertilizer provides primary nutrients for plant growth plus added calcium for proper fruit development, so you can enjoy bountiful crops of home grown fruit. From apples, pears and plums to mangos, pomegranates and figs, Fruit Tree can be used on all varieties of fruiting canes, shrubs and trees.



Item #	Desc	UPC	Vendor	CS/UOS	Location
82390060	5 lb	714360078493	07849	6/6	National

Bio-Fish® 7-7-2



Bio-Fish 7-7-2 is an all-purpose, nutrient-rich fertilizer ideal for vegetable gardens and all types of outdoor plants, trees and shrubs. A good source of nitrogen and phosphorus, DTE Bio-Fish 7-7-2 can be used throughout the growing season to promote vigorous growth, plentiful fruit and beautiful blooms. Once applied, thoroughly mix into the soil surface and water in well.



Item #	Desc	UPC	Vendor	CS/UOS	Location
82390059	5 lb	714360078042	07842	6/6	National

SINGLE INGREDIENTS

Garden Gypsum



Garden Gypsum improves the physical condition of landscape, lawn and garden soils while adding calcium and sulfur. Commonly used to reduce soil compaction and increase drainage in heavy clay soils, gypsum is also used to help remediate and revitalize alkaline, sodic or saline soils.



Item #	Desc	UPC	Vendor	CS/UOS	Location
82390081	5 lb	714360078905	07890	6/6	National

Garden Lime



Garden lime sweetens your soil (raises the pH) to improve plant growth and maximize fertilizer performance. Natural limestone is ground into an ultra-fine powder and then formed into uniform mini granules (prills) for easy spreading and rapid reaction time. Lime supplies calcium, an essential nutrient required for proper plant growth.



Item #	Desc	UPC	Vendor	CS/UOS	Location
82390070	5 lb	714360078707	07870	6/6	National

Feather Meal 12-0-0

Feather Meal 12-0-0 is derived from hydrolyzed, dried and ground poultry feathers. An all-natural source of slow-release nitrogen, it is perfect for corn, tomatoes and fall harvested vegetables. DTE Feather Meal should be incorporated into soils before planting or side dressed throughout the growing season to provide a steady release of nitrogen necessary for optimum plant growth.



Item #	Desc	UPC	Vendor	CS/UOS	Location
82390076	4 lb	714360078813	07881	6/6	National
82390131	20 lb	714360256815	25681	1/1	National

Fish Bone Meal 4-12-0

Down To Earth's Fish Bone Meal 4-12-0 is a marine-based alternative to traditional terrestrial bone meal options and is a great source of organic phosphorus and calcium.



Item #	Desc	UPC	Vendor	CS/UOS	Location
82390118	1 lb	714360178728	17872	12/12	National
82390071	5 lb	714360078721	07872	6/6	National
82390042	25 lb	714360041251	04125	1/1	National

Oyster Shell



Oyster Shell is an all-natural and high-quality source of the essential plant nutrient calcium. Ancient oyster shells are carefully harvested and then ground into small, medium and coarse particles. These irregular shapes provide a sustained release of this valuable nutrient. DTE Oyster Shell also aids in improving structure of soils and building optimum tilth.



Item #	Desc	UPC	Vendor	CS/UOS	Location
82390002	1 lb	714360178148	17814	12/12	National
82390078	5 lb	714360078844	07884	6/6	National

Rose & Flower Mix 4-8-4

Rose & Flower Mix is outstanding for all types of roses, bulbs, flowering shrubs and even onions and garlic. Apply when planting new roses, bulbs and perennials and use throughout the season when new growth appears on existing plants.



Item #	Desc	UPC	Vendor	CS/UOS	Location
82390109	1 lb	714360178025	17802	12/12	National
82390050	5 lb	714360078202	07820	6/6	National
82390133	25 lb	714360324224	32422	1/1	National



Alfalfa Meal 2-0-1

Alfalfa Meal 2-0-1 is an exceptional source of plant-derived nutrients for the garden. It is highly recommended for roses as well as all other vegetables, herbs, flowers and shrubs. Our Alfalfa Meal is derived from sun cured, non-genetically modified alfalfa that is freshly milled to preserve the highest plant nutrient value.

Item #	Desc	UPC	Vendor	CS/UOS	Location
82390112	0.5 lb	714360178858	17805	12/12	National
82390079	4 lb	714360078851	07885	6/6	National

Bone Meal 3-15-0

A wonderful source of phosphorous and calcium for flowering plants, trees and ornamentals, Down To Earth™ Bone Meal 3-15-0 is also recognized as the ideal organic fertilizer when planting bulbs.

Item #	Desc	UPC	Vendor	CS/UOS	Location
82390064	4 lb	714360078585	07858	6/6	National
82390023	25 lb	714360024018	02401	1/1	National
82390018	50 lb	714360019618	01961	1/1	National

Azomite® Powder

AZOMITE is a natural mineral product mined in central Utah. This unique deposit was formed when an ancient volcano erupted and its ash settled into a prehistoric seabed creating a complex mineral composition. AZOMITE can improve plant and root system growth, crop yields, and quality as well as re-mineralize nutrient depleted soils.

Item #	Desc	UPC	Vendor	CS/UOS	Location
82390111	1 lb	714360178049	17804	12/12	National
82390061	5 lb	714360078516	07851	6/6	National

Crab Meal 4-3-0

A byproduct of the West Coast crab harvest, Down To Earth's Crab Meal 4-3-0 is a wonderful source of plant nutrients for vegetable gardens, flower beds and field crops. The coarse texture of DTE Crab Meal is ideal for improving aeration, drainage and overall soil tilth.

Item #	Desc	UPC	Vendor	CS/UOS	Location
82390082	4 lb	714360078943	07894	6/6	National

Bat Guano 7-3-1

Bat Guano 7-3-1 is rich in nitrogen, phosphorus and potash and provides essential plant nutrition for vigorous vegetative growth and prolific fruit and flower development. DTE Bat Guano 7-3-1 is highly effective mixed into soils, applied as a side dress or steeped to make a potent guano tea or foliar spray.

Item #	Desc	UPC	Vendor	CS/UOS	Location
82390120	0.25 lb	714360178872	17887	12/12	National
82390080	2 lb	714360078875	07887	6/6	National

Neem Seed Meal 6-1-2

Neem Seed Meal 6-1-2 is an excellent all natural fertilizer for enriching garden and agricultural soils and encouraging optimum plant development. Cold pressed from the seeds of the fast growing Neem Tree (*Azadirachta indica*), it is also referred to as neem cake.



Item #	Desc	UPC	Vendor	CS/UOS	Location
82390053	5 lb	714360078257	07825	6/6	National

Blood Meal 12-0-0

A readily available source of organic nitrogen, Down To Earth's Blood Meal 12-0-0 is great for heavy feeders, like corn, spinach, broccoli and leafy greens. Nitrogen is essential for all types of growing plants and an adequate seasonal supply ensures plenty of shoots, flowers, fruits and vegetables.

Item #	Desc	UPC	Vendor	CS/UOS	Location
82390113	0.5 lb	714360178070	17807	12/12	National
82390073	4 lb	714360078776	07877	6/6	National
82390028	20 lb	714360027569	02756	1/1	National

Granular Humic Acids

Granular Humic Acids is a highly concentrated source of humic substances that is ideal for use on fields, turf and vegetable gardens. Carefully mined from one of the world's richest deposits, DTE Granular Humic Acids is derived from the ancient remains of decomposed organic plant materials.



Item #	Desc	UPC	Vendor	CS/UOS	Location
82390114	1 lb	714360178278	17827	12/12	National

2024



Seabird Guano 0-11-0

Seabird 0-11-0 guano throughout the flowering period for all indoor and outdoor plants. Strawberries, melons, vegetables and all types of flowers will benefit from mid-season applications to improve yields, quality and flavor while also enhancing the beneficial bacteria activity in your garden soil.



Item #	Desc	UPC	Vendor	CS/UOS	Location
82390025	20lb	714360025930	02539	1/1	National

Langbeinite 0-0-22

Langbeinite 0-0-22 is a naturally mined crystalline mineral that supplies the water-soluble sulfate form of three vital plant nutrients: potassium, magnesium and sulfurs. It's maximum chlorine content is less than 3.0 percent, minimizing the potential for fertilizer "burn," and it's neutral pH does not alter soil activity.



Item #	Desc	UPC	Vendor	CS/UOS	Location
82390062	5 lb	714360078523	07852	6/6	National

Kelp Meal 1-0.1-2

Kelp Meal 1-0.1-2 is pure Ascophyllum nodosum seaweed from the clean, cold waters of the North Atlantic Ocean. Hand-harvested, carefully dried and finely milled, DTE Kelp Meal 1-0.1-2 is an ideal nutrient supplement for all types of vegetables, herbs, flowers and perennials.



Item #	Desc	UPC	Vendor	CS/UOS	Location
82390001	0.5 lb	714360178131	17813	12/12	National
82390072	4 lb	714360078738	07873	6/6	National



BIOLOGICALS

Soluble Root Zone

Soluble Root Zone is a powerful blend of beneficial soil organisms that colonize plant roots and expand into the surrounding soil to greatly increase the absorptive surface area of root systems. Our new professional grade and ultra-concentrated formula of mycorrhizal fungi, Trichoderma and a diverse mix of bacterial species work symbiotically to promote enhanced activity in the rhizosphere, improved soil structure and extensive root growth.



Item #	Desc	UPC	Vendor	CS/UOS	Location
82390143	4 oz	714360366040	36604	12/12	National

Granular Root Zone

Granular Root Zone is a powerful blend of beneficial soil organisms that colonize plant roots and expand into the surrounding soil to greatly increase the absorptive surface area of root systems. Our new professional grade and ultra-concentrated formula of mycorrhizal fungi, Trichoderma and a diverse mix of bacterial species work symbiotically to promote enhanced activity in the rhizosphere, improved soil structure and extensive root growth.



Item #	Desc	UPC	Vendor	CS/UOS	Location
82390139	2 oz	714360361021	36102	24/24	National
82390140	8 oz	714360361083	36108	12/12	National



Acid Lovers® Azalea, Camellia, Rhododendron & Maple Fertilizer

Acid Lovers® dry fertilizer is formulated for acid loving plants. It is ideal for azaleas, camellias, rhododendrons, maples, hollies, gardenias, hydrangeas, blueberries, evergreens, ferns and shade plants. Excellent for use in raised beds during transplanting or feeding mid-season for a nutritional boost.



Item #	Desc	UPC	Vendor	CS/UOS	Location
81160138	1 lb	749688755573	75557	12/12	West
81160186	4 lb	749688121859	703p	12/12	West
81160126	12 lb	749688040129	710	5/5	West
81160167	25 lb	749688250047	732	1/1	West



Natural Wonder® Fruit Tree Fertilizer

Natural Wonder® fertilizer is formulated to feed all fruit trees, berries, and fruiting vines in containers or any backyard soils. It can be used during the initial transplanting after digging the hole or anytime of the year to feed actively growing fruit trees and vines.

Item #	Desc	UPC	Vendor	CS/UOS	Location
81160146	1 lb	749688706568	70656	12/12	West
81160132	12 lb	749688090124	713	5/5	West
81160170	25 lb	749688250092	735	1/1	West

Premium Gold® All Purpose Fertilizer

Premium Gold® All Purpose Fertilizer produces remarkable result. Nutrients are released immediately and over several months. Premium formula provides optimum nutrition. Plants don't lie – it's great for every plant in the garden!

Item #	Desc	UPC	Vendor	CS/UOS	Location
81160147	1 lb	749688708579	70857	12/12	West
81160133	12 lb	749688916875	712	5/5	West
81160171	25 lb	749688250078	734	1/1	West

Annual Bloom Flower Garden Pansy Fertilizer

Annual Bloom® Flower Garden Pansy Fertilizer is formulated for all flowering plants, containerized or in-ground. Use when planting seeds, transplanting established plants, and periodically throughout year – as needed.

Item #	Desc	UPC	Vendor	CS/UOS	Location
81160188	4 lb	749688928557	705p	12/12	West

Exotic Blend® Palm, Tropical & Hibiscus Fertilizer

Exotic Blend® dry fertilizer has been carefully designed for exotic plants such as palm, hibiscus, ferns, and tropical varieties. You'll get remarkable results and larger, natural blooms. We utilize a proven scientific formula that provides optimal levels of plant nutrition for stunning results.



Item #	Desc	UPC	Vendor	CS/UOS	Location
81160141	1 lb	749688750646	75064	12/12	West
81160190	4 lb	749688314138	756P	12/12	West
81160127	12 lb	749688010122	1032	5/5	West

Life All Purpose Fertilizer

100% organic & natural hand crafted blend. Ideal for organic vegetable gardens. No GMOs, chicken manure, sewage sludge ("Bio solids") to taint the cleanliness or safety of our handcrafted blend.

Item #	Desc	UPC	Vendor	CS/UOS	Location
81160145	1 lb	749688711647	71164	12/12	West

Root Zone® Starter Fertilizer

Root Zone® fertilizer is formulated to feed all transplants, vegetable garden plants, both summer and winter plants, in containers or in native soil found in your yard. It is best used when planting seeds or transplanting anything into a new container or at home in the garden.

Item #	Desc	UPC	Vendor	CS/UOS	Location
81160148	1 lb	749688711159	71115	12/12	West

Sweet & Sour® Citrus Fertilizer

Sweet & Sour® fertilizer is formulated to feed all fruit trees, berries, and fruiting vines in containers or any backyard soils. It can be used during the initial transplanting after digging the hole or anytime of the year to feed actively growing fruit trees and vines.

Item #	Desc	UPC	Vendor	CS/UOS	Location
81160149	1 lb	749688009003	900	12/12	West

Lawn and Garden Fertilizer

Our nitrogen fertilizer promotes lush, green growth and long term nutrition for lawns, vegetables, flowers, trees, shrubs, annuals, and perennials. A true organic, pelletized all purpose fertilizer that produces remarkable results because nutrients are released quickly yet continue to feed for several months. Ultra-premium scientific formula provides optimum levels of primary essential plant nutrients. TruBiotic ensures organic nutrients are thoroughly broken down then released in the soil for plant roots to absorb them as they are needed. Feeds for several months.



Item #	Desc	UPC	Vendor	CS/UOS	Location
81160137	18 lb	749688646994	699	1/1	West

2024



Blood Meal

Premium kiln-dried Blood Meal is an excellent source of organic nitrogen that promotes growth in all types of plants. It contains Superactive soil and seed inoculant and 5 strains of beneficial soil microbes. TruBiotic ensures organic nutrients are thoroughly broken down and then released in the soil for plant roots to absorb them as they are needed, contributing to drought tolerance, enhanced nutrient availability and increased plant performance. As an added bonus, it helps to repel deer! Use on vegetables, roses and flowers, trees and shrubs, container plants, tropical plants and all plants in vegetative growth. Can be used as a fertilizer tea to feed plants.

Item #	Desc	UPC	Vendor	CS/UOS	Location
81160116	2 lb	749688077712	716	12/12	West

Kelp Meal

Kelp Meal Plant Food, Fertilizer 2 lb plant food with cold water Norwegian kelp is an excellent source of potash and promotes health in all planting applications. Contains minerals, growth regulators, vitamins, hormones, and enzymes. Infused with TruBiotic which ensures organic nutrients are thoroughly broken down and then released in the soil for plant roots to absorb them as they are needed, contributing to drought tolerance, enhanced nutrient availability and increased plant performance.

Item #	Desc	UPC	Vendor	CS/UOS	Location
81160173	2.5 lb	749688077767	725	12/12	West

Alfalfa Meal

Alfalfa Meal is fast acting and excellent source of Magnesium - which roses love. It contains natural growth stimulant Triacentalol which boosts growth of all plant types. TruBiotic which ensures organic nutrients are thoroughly broken down and then released in the soil for plant roots to absorb them as they are needed, contributing to drought tolerance, enhanced nutrient availability and increased plant performance.

Item #	Desc	UPC	Vendor	CS/UOS	Location
81160181	3 lb	749688077736	720	12/12	West

Compost Starter

Compost Starter produces remarkable results because it significantly speeds up the decomposition of raw organic materials to create true organic humus. TruBiotic® ensures organic nutrients are thoroughly broken down then released in the compost pile for preparation of soil applications.

Item #	Desc	UPC	Vendor	CS/UOS	Location
81160183	3 lb	749688077118	727	4/4	West

Bone Meal

Bone Meal is an excellent source of organic phosphorous, providing both long term and short term benefits. Great for root and fruit development. It benefits bulbs, flowers, roses, vegetables, all blooming plants, trees and shrubs. It contains Superactive soil and seed inoculant and 5 strains of beneficial soil microbes. TruBiotic ensures organic nutrients are thoroughly broken down and then released in the soil for plant roots to absorb them as they are needed, contributing to drought tolerance, enhanced nutrient availability and increased plant performance.

Item #	Desc	UPC	Vendor	CS/UOS	Location
81160151	2.5 lb	749688077729	718	12/12	West

Fish Bone Meal

Pasteurized Fish Bone Meal is an excellent source of organic phosphorous. It benefits plants in all stages of growth and is especially beneficial for roots, buds and blooms. It contains Superactive soil and seed inoculant and 5 strains of beneficial soil microbes. TruBiotic ensures organic nutrients are thoroughly broken down and then released in the soil for plant roots to absorb them as they are needed, contributing to drought tolerance, enhanced nutrient availability and increased plant performance.

Item #	Desc	UPC	Vendor	CS/UOS	Location
81160152	2.5 lb	749688077774	722	12/12	West

Total Advantage® Rose & Flower Fertilizer

Dr. Earth® Total Advantage® Rose & Flower Fertilizer is formulated to feed flowering plants naturally to promote bigger and more abundant blooms. Dr. Earth® Total Advantage® Rose & Flower Fertilizer is great for all roses, flowers, flowering trees, shrubs as well as annuals & perennials.



Item #	Desc	UPC	Vendor	CS/UOS	Location
81160352	24 oz	749688410380	1038	12/12	West
81160150	1 lb	749688728553	72855	12/12	West
81160135	12 lb	749688030120	709	5/5	West
81160172	25 lb	749688250030	731	1/1	West

Pure Gold All Purpose Pelletized Fertilizer

Pure Gold is a true pelletized organic all purpose fertilizer that produces remarkable results because nutrients are released quickly yet continue to feed for several months. Ultra-premium scientific formula provides optimum levels of primary essential plant nutrients. TruBiotic ensures organic nutrients are thoroughly broken down then released in the soil for plant roots to absorb them as they are needed. Feeds for several months. Great for every plant in the garden.



Item #	Desc	UPC	Vendor	CS/UOS	Location
81160333	24 oz	749688410403	1040	12/12	West
81160335	3 lb	749688007580	758P	12/12	West

Flower Girl® Bud & Bloom Booster Fertilizer

Flower Girl® dry fertilizer produces fantastic results as it releases some nutrients quickly and others may last up to several months. Ultra-premium scientific formula provides measured and optimal plant nutrients for maximum plant health and growth.



Item #	Desc	UPC	Vendor	CS/UOS	Location
81160234	24 oz	749688410410	1041	12/12	West
81160142	1 lb	749688707923	70792	12/12	West
81160192	4 lb	749688803090	707p	12/12	West
81160128	12 lb	749688735216	101	5/5	West

Home Grown® Tomato, Vegetable & Herb Fertilizer

Home Grown® fertilizer is formulated to feed vegetable gardens, summer and winter crops, container plantings or native backyard soil. Use it during initial planting of seeds, transplanting, and on a regular basis as a top dressing or compost tea.



Item #	Desc	UPC	Vendor	CS/UOS	Location
81160257	24 oz	749688410397	1039	12/12	West
81160143	1 lb	749688734165	73416	12/12	West
81160130	12 lb	749688122085	711	5/5	West
81160168	25 lb	749688250054	733	1/1	West



Pump & Grow Cactus & Succulent

Pump & Grow Cactus and Succulent Plant Food, 1-1-2 Fertilizer, 8 oz., is a quick and easy to use product to fertilize your indoor and outdoor containers plants. Simply applying 2 pumps of fertilizer to your plants and water within 24hrs. 100% sustainable nutrients for 2 weeks. Excellent for transplanting or regular maintenance feeding of cactus and succulents.

Item #	Desc	UPC	Vendor	CS/UOS	Location
81160309	8 oz	749688410656	1065	12/12	West
81160330	16 oz	749688410779	1077	12/12	West

Home Grown Pump & Grow Organic Tomato & Vegetable Food

Pump & Grow Organic Tomato and Vegetable Food, 3-2-2 Fertilizer 8oz is a very quick and easy to use products for your garden and herbs. Simply applying 2 pumps of fertilizer to your plants feeds them 100% sustainable nutrients for 2 weeks. Quick & Easy - Pump & Grow!

Item #	Desc	UPC	Vendor	CS/UOS	Location
81160315	8 oz	749688410663	1066	12/12	West
81160314	16 oz	749688410786	1078	12/12	West

Pump & Grow Liquid-Concentrate

Pump & Grow Liquid-Concentrate Organic Plant Food 1-1-1 Fertilizer 8oz. A quick an easy solution for feeding plants in your garden. Derived from highest grade natural market super-foods such as seafoods, raw meats, fruits, vegetables, whole grains and everything we buy for our own family Simply applying 2 pumps of fertilizer to your plants feeds you them 100% sustainable nutrients for 2 weeks.

Item #	Desc	UPC	Vendor	CS/UOS	Location
81160317	8 oz	749688410724	1072	12/12	West
81160316	16 oz	749688410847	1084	12/12	West

Pump & Grow Pure Gold All Purpose

Pump & Grow All Purpose Plant Food, 1-1-1 Fertilizer, 8 oz., concentrated liquid fertilizers are very quick and easy to use because it can be applied directly to the soil. Simply apply two pumps to the soil and water within 24 hours to feed your plants 100% sustainable nutrients for 2 weeks. Gardening made easy with no mixing and no mess.

Item #	Desc	UPC	Vendor	CS/UOS	Location
81160325	8 oz	749688410854	1085	12/12	West
81160324	16 oz	749688410861	1086	12/12	West



Holly-tone® 4-3-4

For acid-loving plants, such as hollies, azaleas, camellias, evergreens, hydrangeas, dogwoods, blueberries, strawberries and rhododendrons. It is rich in natural organics and enhanced with Bio-tone®, our proprietary blend of beneficial microbes. Bio-tone biologically enhances our natural plant food to ensure superior plant growth. Used and recommended by Professionals.

Item #	Desc	UPC	Vendor	CS/UOS	Location
80030019	4 lb.	050197001045	HT4	12/12	East
80030036	8 lb.	050197001083	HT8	6/6	East
80030107	18 lb.	050197001182	HT18	1/1	East
80030106	36 lb.	050197001366	HT36	1/1	East
80030130	50 lb.	050197001502	HT50	1/1	East

Bulb-tone® 3-5-3

A premium plant food formulated specifically for bulbs and tubers. It contains bone meal and other natural organics to meet the special nutritional needs of these plants. Bulb-tone's all natural formula contains Bio-tone®, the proprietary blend of beneficial microbes. Bulb-tone feeds slowly, safely, and will provide a long lasting food reservoir to ensure superior results.

Item #	Desc	UPC	Vendor	CS/UOS	Location
80030015	4 lb.	050197006040	BT4	12/12	East
80030112	18 lb.	050197006187	BT18	1/1	East

Tree-tone® 6-3-2

A premium plant food formulated specifically for shade, fruit, and ornamental trees. Tree-tone's all natural formula contains Bio-tone®, our proprietary blend of beneficial microbes. Bio-tone biologically enhances our natural plant food to ensure superior plant growth. The natural organics in Tree-tone break down gradually to provide a safe, long lasting nutrient reservoir to feed the entire tree: leaves, trunk, and roots.

Item #	Desc	UPC	Vendor	CS/UOS	Location
80030023	4 lb.	050197007047	TR4	12/12	East
80030118	18 lb.	050197007184	TR18	1/1	East
80030117	36 lb.	050197007368	TR36	1/1	East

Flower-tone® 3-4-5

A premium flower food that is low in nitrogen and higher in phosphorous and potassium to maintain good plant growth and promote blooms rather than heavy foliage. Flower-tone's natural organics breakdown gradually providing a safe, long lasting food reservoir activated throughout the growing season. Flower-tone's all natural formula contains Bio-tone®, the proprietary blend of beneficial microbes. Bio-tone biologically enhances the natural plant food to ensure superior plant growth.

Item #	Desc	UPC	Vendor	CS/UOS	Location
80030017	4 lb.	050197029049	FT 4	12/12	East
80030110	18 lb.	050197029186	FT18	1/1	East

Citrus-tone® 5-2-6

Citrus-tone's all natural formula contains Bio-tone®, our proprietary blend of beneficial microbes. Bio-tone® biologically enhances our natural plant food to ensure superior plant growth.

Item #	Desc	UPC	Vendor	CS/UOS	Location
80030016	4 lb.	050197050043	CT4	12/12	East

Azalea-tone® 4-3-4

Long lasting, slow release for better blooms and foliage. Ideal for Azalea, Camellia, Gardenia & Rhododendron.

Item #	Desc	UPC	Vendor	CS/UOS	Location
80030173	4 lb.	050197065047	AT4	12/12	East
80030172	8 lb.	050197065085	AT8	6/6	East

Garden Food 10-10-10

A general purpose garden food that provides the three major nutrients in equal amounts. Promotes vigorous growth in all flowering plants and vegetables.

Item #	Desc	UPC	Vendor	CS/UOS	Location
80030031	6.75 lb.	050197028066	GF101010/6	6/6	East



Evergreen-tone® 4-3-4

Feed in the Spring and late Fall at half the Spring rate for BEAUTIFUL Evergreens, Pines, Conifers & More! 100% natural & organic ingredients with no fillers or sludges. Long lasting, slow-release feeding with our exclusive Bio-tone Microbes plus 5% Calcium, 1% Magnesium & 5% Sulfur. Also for Acid loving plants like Hydrangeas.

Item #	Desc	UPC	Vendor	CS/UOS	Location
80030215	8 lb.	50197067089	ET8	6/6	East

Berry-tone® 4-3-4

An all-natural plant food formulated specifically for blueberries, strawberries and raspberries. It is safe, long lasting, slow release nitrogen and will provide the nutrients necessary for bigger fruit growth.

Item #	Desc	UPC	Vendor	CS/UOS	Location
80030187	4 lb.	050197066044	BRT4	12/12	East

Iron-tone® 3-0-3

A premium plant food formulated to correct chlorosis and turn yellow foliage to a deep, dark green color. Iron-tone does not stain concrete, and can be used for plant or lawn applications.

Item #	Desc	UPC	Vendor	CS/UOS	Location
80030065	5 lb.	050197054058	IT5	12/12	East

Palm-tone® 4-1-5

Palm-tone is the result of The Espoma Company's expertise in natural organics combined with recommendations from leading research universities. Palm-tone's all natural formula contains Bio-tone®, the proprietary blend of beneficial microbes. Bio-tone biologically enhances the natural plant food to ensure superior plant growth.

Item #	Desc	UPC	Vendor	CS/UOS	Location
80030058	4 lb.	050197039048	PM4	12/12	East

Rose-tone® 4-3-2

A premium rose food designed to supply the necessary nutrients for growing prize winning roses. The organics in Rose-tone breakdown gradually providing a safe, long lasting food reservoir activated throughout the growing season. Rose-tone's all natural formula contains Bio-tone®, the proprietary blend of beneficial microbes.

Item #	Desc	UPC	Vendor	CS/UOS	Location
80030021	4 lb.	050197004046	RT4	12/12	East
80030038	8 lb.	050197004084	RT8	6/6	East
80030111	18 lb.	050197004183	RT18	1/1	East

Garden-tone® 3-4-4

An all-natural plant food formulated specifically for vegetable gardens. It is safe, long lasting, and will provide the nutrients necessary for vigorous and productive plants. Garden-tone's all natural formula contains Bio-tone®, our proprietary blend of beneficial microbes. Bio-tone biologically enhances our natural plant food to ensure superior plant growth.

Item #	Desc	UPC	Vendor	CS/UOS	Location
80030018	4 lb.	050197003049	GT4	12/12	East
80030035	8 lb.	050197003087	GT8	6/6	East
80030114	18 lb.	050197003186	GT18	1/1	East
80030113	36 lb.	050197003360	GT36	1/1	East

Plant-tone® 5-3-3

The original all natural plant food made from the finest quality organics available. Plant-tone's natural organics break down gradually, providing a safe, long lasting food reservoir activated throughout the growing season. Plant-tone's all natural formula contains Bio-tone®, the proprietary blend of beneficial microbes. Bio-tone biologically enhances the natural plant food to ensure superior plant growth.

Item #	Desc	UPC	Vendor	CS/UOS	Location
80030020	4 lb.	050197002042	PT4	12/12	East
80030037	8 lb.	050197002080	PT8	6/6	East
80030109	18 lb.	050197002189	PT18	1/1	East
80030108	36 lb.	050197002363	PT36	1/1	East
80030131	50 lb.	050197002509	PT50	1/1	East



Kelp Meal 1-0-2

Kelp Meal is brown seaweed harvested from the cold, nutrient-rich waters of the north Atlantic Ocean. Espoma® Kelp Meal, Ascophyllum nodosum, is the best species of kelp for both horticultural and agricultural use. Espoma® Kelp Meal is approved for organic gardening.

Item #	Desc	UPC	Vendor	CS/UOS	Location
80030072	4 lb.	050197027045	KM4	12/12	East

Garden Food 5-10-5

An agricultural grade all purpose plant food that helps plants quickly absorb nutrients. Less Nitrogen and Potassium than 10-10-10. For use on flowers, vegetables, trees and shrubs .

Item #	Desc	UPC	Vendor	CS/UOS	Location
80030032	6.75 lb.	050197019064	GF5105/6	6/6	East

Bone Meal 4-12-0

An all natural organic source of Nitrogen and Phosphorus. Bone Meal helps develop sturdy root systems, promotes plant growth, and is ideal as a supplement for bulbs, flowers and roses.

Item #	Desc	UPC	Vendor	CS/UOS	Location
80030179	4 lb.	050197010092	BM04	12/12	East
80030070	10 lb.	050197010108	BM10	6/6	East
80030069	24 lb.	050197010245	BM24	1/1	East

Bio-tone® Starter 4-3-3

Granular Bio-tone® starter is microbe enhanced all natural plant food. Contains an active community of living microbes blended with humates. Promotes faster establishment, deeper roots and a superior soil structure. Reduces transplant loss.



Item #	Desc	UPC	Vendor	CS/UOS	Location
80030063	25lb.	050197035255	BTSG25	1/1	East

Bio-tone® Starter Plus 4-3-3

Bio-tone® Starter Plus is an all-natural plant food that is made with a stronger concentration of beneficial bacteria and Mycorrhizae. The ideal starter plant food, originally designed for professionals. Bio-tone® Starter Plus will increase root mass and help avoid transplant loss. This is the only Espoma Tone that contains Mycorrhizae.

Item #	Desc	UPC	Vendor	CS/UOS	Location
80030062	5 oz.	050197038027	BTSP5OZ	80/80	East
80030014	4 lb.	050197038041	BTSP4	12/12	East
80030132	8 lb.	050197038089	BTSP8	6/6	East
80030121	18 lb.	050197038188	BTSP18	1/1	East
80030059	25 lb.	050197038256	BTSP25	1/1	East

Triple Phosphate 0-45-0

An enriched source of Phosphorus which helps with flower and fruit formation as well as root growth. For use on flowers, vegetables, trees and shrubs.

Item #	Desc	UPC	Vendor	CS/UOS	Location
80030103	6.5 lb.	050197016063	TP6	6/6	East

Tomato-tone® 3-4-6

A premium plant food formulated specifically for growing plump and juicy tomatoes. Tomato-tone's organic composition feeds your plants naturally and will not force rapid growth at the expense of blooms and tomato yield. Tomato-tone's all natural formula contains Bio-tone® that biologically enhances the natural plant food to ensure superior plant growth. Enhanced with 8% calcium to help prevent blossom end rot.

Item #	Desc	UPC	Vendor	CS/UOS	Location
80030022	4 lb.	050197009041	TO4	12/12	East
80030052	8 lb.	050197009089	TO8	6/6	East
80030115	18 lb.	050197009188	TO18	1/1	East

Blood Meal 12-0-0

An all natural organic source of nitrogen. Blood Meal promotes rapid growth and deep, dark green color, and is an ideal supplement for all annuals and perennials. A time proven remedy for sickly plants.

Item #	Desc	UPC	Vendor	CS/UOS	Location
80030180	3 lb.	050197013093	DB03	12/12	East
80030073	17 lb.	050197013178	DB17	1/1	East



Cow Manure Compost Blend

A Blend of Dehydrated Cow Maure and Compost for Lawn and Garden.



Item #	Desc	UPC	Vendor	CS/UOS	Location
80030200	1 cu ft	050197716017	DCM1	65/10	East

Compost Starter

Formulated to accelerate the process of home composting materials including manure, grass, leaves and food waste. Compost Starter contains billions of microbes specially culture to speed the decomposition of difficult to compost organic matter. These are combined with the proper energy sources and pH balancer's to assure composting success.



Item #	Desc	UPC	Vendor	CS/UOS	Location
80030080	4 lb.	050197023047	CS4	12/12	East

Chicken Manure 5-2-3

All natural poultry manure approved for organic gardening. Dehydrated and granulated for easy application.



Item #	Desc	UPC	Vendor	CS/UOS	Location
80030149	3.75 lb.	050197018036	GM3	12/12	National
80030148	25 lb.	050197018258	GM25	1/1	East

Soil Perfector

Soil Perfector is made from a naturally derived, ceramic mineral that is kiln-fired at temperatures in excess of 2000° F. This process creates a durable, lightweight granule containing thousands of tiny storage spaces that hold the perfect balance of water, air and nutrients for an improved soil structure.



Item #	Desc	UPC	Vendor	CS/UOS	Location
80030138	30 lb	050197034302	SPF30	1/1	East



Tomato! 1-3-1

Organic liquid plant food ideal for tomatoes and vegetables. Produces plump, juicy tomatoes.

Item #	Desc	UPC	Vendor	CS/UOS	Location
80030218	8 oz.	050197313087	TOPF8	6/6	East
80030222	16 oz.	50197313162	TOPF16	6/6	East

Bloom! 1-3-1

Bloom! Liquid Plant Food promotes flowers and fruit in all indoor and outdoor flowering plants, including hanging baskets. Espoma Bloom! is approved for organic gardening.

Item #	Desc	UPC	Vendor	CS/UOS	Location
80030220	16 oz.	50197304160	BL16	6/6	East

Grow! 2-2-2

Espoma organic indoor plant food is specially formulated with organic ingredients, all major plant nutrients & millions of beneficial microbes delivering optimum plant health & top performance results. For both outdoor and indoor use.

Item #	Desc	UPC	Vendor	CS/UOS	Location
80030221	16 oz.	50197303163	GR16	6/6	East



CULTIVATION NATION



Item #	Desc	UPC	Vendor	CS/UOS	Location
82000196	Flower - 1 lb	752289260636	0636	12/12	East
82000193	Veggie - 1 lb	752289260629	629	12/12	National
82000176	Grow - 1 qt	752289260186	186	12/12	National
82000188	Bloom - 1 qt	752289260261	261	12/12	National
82000215	Ph Down - 1 qt	752289270147	270147	12/12	National
82000218	Ph Up - 1 qt	752289270116	270116	12/12	National
82000214	Ph Down - 1 pnt	752289270130	270130	12/12	National
82000217	Ph Up - 1 pnt	752289270109	270109	12/12	National
82000182	Micro - 1 pnt	752289260223	0223	12/12	National



Open Sesame 5-45-19

For Early Flowering Stage. Open Sesame® is a blend of nutrients specifically designed for use during the early weeks of flowering. Open Sesame® supports vigorous flowering and bud development. Use in soilless mixes, soils, hydroponics and aeroponic systems.



Item #	Desc	UPC	Vendor	CS/UOS	Location
82000005	6 oz	752289201530	201530	24/24	National
82000006	1 lb	752289201639	201639	12/12	National

Marine Cuisine 10-7-7

Seafood for Your Garden! Marine Cuisine® is an all-purpose fertilizer that blends oceanbased ingredients like crab meal, shrimp meal, seabird guano, and kelp with mineral plant foods to give your garden a quick boost and provide long-lasting, slow release nutrition.



Item #	Desc	UPC	Vendor	CS/UOS	Location
82000081	4 lb	752289790393	790393	8/8	National
82000083	50 lb	752289790430	790430	1/1	National

Happy Frog All Purpose Dry Fertilizer

Happy Frog All-Purpose Fertilizer is a ready-to-use blend of natural fertilizers and microorganisms that deliver nutrition where your plants need it most. Highly recommended for vegetable gardens, annual and perennial flower gardens, ornamental plantings, and all types of container gardening.



Item #	Desc	UPC	Vendor	CS/UOS	Location
82000066	50 lb	752289600555	600555	1/1	National

Tomato & Vegetable Dry Fertilizer

This fertilizer also contains calcium which helps prevent blossom end rot and builds stronger cell walls, boosting the plants ability to resist disease. Mycorrhizal fungi are included to help increase root efficiency, which may enhance nutrient uptake and water absorption.



Item #	Desc	UPC	Vendor	CS/UOS	Location
82000064	50 lb	752289600517	600517	1/1	National

Cha Ching 9-50-10

For Late Flowering Through Harvest. Cha Ching® is a high-phosphorus fertilizer that is designed to help support late stage fruiting processes.



Item #	Desc	UPC	Vendor	CS/UOS	Location
82000057	6 oz	752289501333	510333	24/24	National
82000051	1 lb	752289501432	501432	12/12	National

Trio Pack

Trio Pack features one each; Big Bloom quart Grow Big quart Tiger Bloom quart (4 trio packs per case)



Item #	Desc	UPC	Vendor	CS/UOS	Location
82000100	Soil Trio Pack	752289791000	791000	4/4	National
82000107	Hydroponic Trio Pack	752289792007	792007	4/4	National

Beastie Bloomz 0-50-30

Beastie Bloomz® is a high-phosphorus soluble fertilizer specially formulated to support blossom development during mid to late flowering. For use in soilless mixes, soils, hydroponics, and aeroponic systems.



Item #	Desc	UPC	Vendor	CS/UOS	Location
82000049	6 oz	752289501319	501319	24/24	National
82000050	1 lb	752289501418	501418	12/12	National

Don't Bug Me Insect Spray

Indoor/Outdoor Home & Garden Spray. Don't Bug Me® is a fast, effective solution for most common garden pests. Because its active ingredient is Pyrethrum, which is derived from chrysanthemum flowers, it can be applied up to the day of harvest on any fruit or vegetable.



Restricted in NY.

Item #	Desc	UPC	Vendor	CS/UOS	Location
82000086	24 oz RTU	752289790508	790508	12/12	National



HAPPY FROG FERTILIZER



Item #	Desc	UPC	Vendor	CS/UOS	Location
82000046	Acid Loving Dry Fert 4 lb bag 4-5-3: Designed for Low pH Lovers	752289500626	500626	12/12	National
82000042	All Purpose Dry Fert 4 lb bag 6-4-5: Flowers, Vegetables and Ornamentals	752289500541	500541	12/12	National
82000045	Citrus & Avocado Dry Fert 4lb bag 7-3-3: Formulated for Citrus and Avocado Trees	752289500602	500602	12/12	National
82000041	Fruit & Flower Dry Fert 4 lb bag 4-9-3: Supports Abundant Fruiting & Flowering	752289500527	500527	12/12	National
82000043	Japanese Maple Dry Fert 4 lb bag 4-3-4: Helps Encourage Dense Vegetative Growth	752289500565	500565	12/12	National
82000044	Jump Start Dry Fert 4 lb bag 3-4-3: For Transplant Seedlings and Re-Potted Plants	752289500589	500589	12/12	National
82000047	Steamed Bone Meal Dry Fert 4lb bag 3-12-0: Provides Phosphorus at all Stages of Growth	752289500640	500640	12/12	National
82000040	Tomato & Vegetable Dry Fert 4lb bag 5-7-3: Designed for Vigorous Feeders	752289500503	500503	12/12	National
82000048	Cavern Culture Dry Fert 4 lb bag 1-12-0: Bat Guano, Seabird Guano and Rock Phosphate	752289500664	500664	12/12	National

PLANT CARE & FOOD

2024

BUSH DOCTOR FERTILIZER



Item #	Desc	UPC	Vendor	CS/UOS	Location
82000114	SledgeHammer 1 pt Nutrient Rinse - Encourages Water Movement - Removes Buildup	752289793806	793806	12/12	National
82000091	SledgeHammer 1 qt Nutrient Rinse - Encourages Water Movement - Removes Buildup	752289790805	790805	12/12	National
82000117	Bembé 1 pt 0-1-3: Enhance Sweetness - Created with a Complex Array of Sugars & Nutrients	752289794056	794056	12/12	National
82000115	Boomerang 1 pt 2-0.2-0.3: Supports Root Zone "Comeback Formula"	752289793851	793851	12/12	National
82000093	Boomerang 1 qt 2-0.2-0.3: Supports Root Zone "Comeback Formula"	752289790850	790850	12/12	National
82000116	Flowers Kiss 1 pt 1-0.30-0.05: Foliar Plant Food - Providing Nutrition From Top Down	752289793950	793950	12/12	East
82000113	Kangaroots 1 pt 0.8-0.1-0.03: Enhances Root Efficiency in the Rhizosphere	752289793769	793769	12/12	National
82000089	Kangaroots 1 qt 0.8-0.1-0.03: Enhances Root Efficiency in the Rhizosphere	752289790768	790768	12/12	National
82000118	Kelp Me Kelp You 1 pt 0.5-0-0.5: Seaweed Plant Food	752289794209	794209	12/12	National
82000103	Kelp Me Kelp You 1 qt 0.5-0-0.5: Seaweed Plant Food	752289791208	791208	12/12	National
82000112	Microbe Brew 1 pt 1-0.3-0.2: Microbe Plant Food - Enhance Nutrient Uptake	752289793714	793714	12/12	National
82000087	Microbe Brew 1 qt 1-0.3-0.2: Microbe Plant Food - Enhance Nutrient Uptake	752289790713	790713	12/12	National
82000119	Wholly Mackerel 1 pt 3-1-0: Fish Fertilizer - Supports Vigorous Growth	752289794308	794308	12/12	National
82000105	Wholly Mackerel 1 qt 3-1-0: Fish Fertilizer - Supports Vigorous Growth	752289791307	791307	12/12	National
82000211	CAL-MAG 1 pt OMRI Listed Strengthen Cell Walls And Aid In Fruit Development	752289520075	520075	12/12	National
82000212	CAL-MAG 1 qt OMRI Listed Strengthen Cell Walls And Aid In Fruit Development	752289520082	520082	12/12	National



Grow Big

Liquid Concentrate Fertilizer with Micronutrients. Get your garden going with Grow Big®, a liquid plant food that supports lush, vegetative growth.



Item #	Desc	UPC	Vendor	CS/UOS	Location
82000109	1 pt 6-4-4	752289793202	793202	12/12	National
82000069	1 qt 6-4-4	752289790201	790201	12/12	National
82000070	1 qt Hydroponic 3-2-6	752289790218	790218	12/12	National
82000075	1 gal 6-4-4	752289790300	790300	4/4	National
82000076	2.5 gal	752289790317	790317	2/2	National

2024

Big Bloom 0-0.5-0.7

FoxFarm's Big Bloom® Liquid Plant Food is a carefully selected blend of fertilizers formulated to support multiple blooms and seed formations. This liquid plant food supplies nutrients that your plants can access immediately. OMRI Listed® and Registered CDFA Organic Input Material.



Item #	Desc	UPC	Vendor	CS/UOS	Location
82000108	1 pt	752289793103	793103	12/12	National
82000068	1 qt	752289790102	790102	12/12	National
82000095	1 gal	752289790904	790904	4/4	National
82000096	2.5 gal	752289790911	790911	2/2	East

Tiger Bloom 2-8-4

Tiger Bloom® is a phosphorus fertilizer that contains nitrogen to support vigorous growth. Tiger Bloom® is designed to encourage abundant fruit, flower and multiple bud development.



Item #	Desc	UPC	Vendor	CS/UOS	Location
82000111	1 pt	752289793226	793226	12/12	National
82000071	1 qt	752289790225	790225	12/12	National
82000077	1 gal	752289790324	790324	4/4	National

ferti-lome



All Purpose Houseplant Food 10-10-10

Use to feed all potted plants, indoors and outdoors, including houseplants. 8oz liquid concentrate

Item #	Desc	UPC	Vendor	CS/UOS	Location
82280181	8 oz	732221180017	18001	12/12	East

Succulent & Cactus Plant Food 2-7-7

Use to feed Cactus, Jade, Aloe and all succulents. 8oz liquid concentrate.

Item #	Desc	UPC	Vendor	CS/UOS	Location
82280182	8 oz	732221180116	18011	12/12	East

Orchid Plant Food 9-7-9

Use to feed all Orchids. 8oz liquid concentrate.

Item #	Desc	UPC	Vendor	CS/UOS	Location
82280183	8 oz	732221180215	18021	12/12	East

African Violet & Blooming Plant Food 8-10-8

Use to feed all African Violets and other flowering plants. 8oz liquid concentrate.

Item #	Desc	UPC	Vendor	CS/UOS	Location
82280184	8 oz	732221180314	18031	12/12	East

Garden Cote 12-12-12

Specially formulated for flowers, vegetables and citrus blooms. NPK + Micros encourage greener flowering plants with more blooms. Can be used for annuals, perennials, petunias, pansies, impatiens, tomatoes, garden vegetables, peppers, melons and berries. It also can be added to soil around trees and shrubs, and applied to bulbs and bedding transplants. Time release fertilizer



Item #	Desc	UPC	Vendor	CS/UOS	Location
82280140	1 lb	732221121409	12140	24/24	East
82280141	4.5 lb	732221121416	12141	12/12	East



Gardener's Special Plant Food 11-15-11

Gardener Special contains both fast and slow release nitrogen, plus the necessary trace elements to help promote plant development. For use on vegetables roses, flowers, trees and shrubs.

Item #	Desc	UPC	Vendor	CS/UOS	Location
82280062	4 lb	732221107854	10784	12/12	East

Premium Bedding Plant Food 7-22-8

A premium quality bedding plant food with micronutrients and slow release Nitrogen that assists in growing healthy bedding plants and perennials.

Item #	Desc	UPC	Vendor	CS/UOS	Location
82280056	4 lb	732221107618	10761	12/12	East

2024

All Purpose Water Soluble Plant Food 20-20-20

This 20-20-20 plant food is ideal for all potted plants. Works best when used as a soil drench combined with a foliar spray.

Item #	Desc	UPC	Vendor	CS/UOS	Location
82280124	1.5 lb	732221117211	11721	12/12	East
82280125	3 lb	732221117228	11722	12/12	East

Rose Food 14-12-11

Rose Food provides the right nutrients to produce green leaves and new growth, which new blooms develop on Roses. Apply monthly during the growing season for bountiful blooms.

Item #	Desc	UPC	Vendor	CS/UOS	Location
82280066	4 lb	732221108301	10830	12/12	East

Tree And Shrub Food 19-8-10

Great for all types of trees and shrubs like shade trees, nut trees, evergreens, citrus, tropical and flowering trees. Feed trees and shrubs twice a year. Contains trace elements.

Item #	Desc	UPC	Vendor	CS/UOS	Location
82280071	4 lb	732221108646	10864	12/12	East
82280072	20 lb	732221108653	10865	1/1	East

Blooming & Rooting Plant Food

A highly concentrated plant food that helps promote vigorous blooming, root development, larger blooms on flowering shrubs, trees, Roses, Orchids, Tomatoes and all blooming and fruit bearing plants.

Item #	Desc	UPC	Vendor	CS/UOS	Location
82280133	1.5 lb	732221117785	11778	24/24	East
82280130	3 lb	732221117716	11771	12/12	East
82280131	8 oz	732221117723	11772	12/12	East

Fertilome Azalea Camellia Rhododendron Food 9-15-13

Contains plant food with trace elements which create an acidic growing environment thats ideal for Azaleas, Camellias and Rhododendron to thrive and grow.

Item #	Desc	UPC	Vendor	CS/UOS	Location
82280044	4 lb	732221106857	10685	12/12	East
82280045	15 lb	732221106956	10695	1/1	East

Tree And Shrub Food 19-8-10

Great for all types of trees and shrubs like shade trees, nut trees, evergreens, citrus, tropical and flowering trees. Feed trees and shrubs twice a year. Contains trace elements.

Item #	Desc	UPC	Vendor	CS/UOS	Location
82280065	20 lb	732221108226	10822	1/1	East

ferti-lome



Fish Emulsion Fertilizer 5-1-1

Derived from concentrated fish solubles that supply the natural release of essential nutrients for the development of green foliage, vigorous root systems and solid plant structure.

Item #	Desc	UPC	Vendor	CS/UOS	Location
82280029	16 oz	732221106116	10611	12/12	East
82280030	32 oz	732221106123	10612	12/12	East

Chelated Iron EDDHA 6% Water Soluble

A source of iron that is water soluble and readily available to plants. It can be used to prevent or correct chlorosis, the yellowing of leaves and other nutrient deficiencies in potted plants, shrubs, lawns, trees, flowers and vegetables.

Item #	Desc	UPC	Vendor	CS/UOS	Location
82280032	16 oz	732221106253	10625	12/12	East

Root Stimulator & Plant Starter Solution 4-10-3

User both indoor or outdoor, for all of your new plantings. Stimulates early root formation, and stronger root development. 4-10-3 with indole-3-butyric acid.

Item #	Desc	UPC	Vendor	CS/UOS	Location
82280038	16 oz	732221106406	10640	12/12	East
82280039	32 oz	732221106451	10645	12/12	East
82280040	1 gal	732221106505	10650	4/4	East

Hi-Yield

Fast Acting Gypsum

Fast-Acting Gypsum starts working immediately to help loosen compacted soil, including heavy clay soil and repairs salt damaged soil. **Not for sale in AK, DE, HI, MD, NJ, RI, WI**



Item #	Desc	UPC	Vendor	CS/UOS	Location
82280225	4 lb	732221320543	32054	12/12	East

Calcium Nitrate

Calcium nitrate is ideal for use in vegetable gardens to prevent blossom end rot. It provides both calcium and nitrogen. Supporting cell formation, it neutralizes acids to detoxify the plants for a healthier growth! The nitrogen component is also responsible for fueling protein production and essentially leafy growth. The perfect purchase for a natural way to have a healthier garden with brighter, and better results. Guaranteed to work like a charm every time!



Item #	Desc	UPC	Vendor	CS/UOS	Location
82280238	4 lb	732221321182	32118	12/12	East

Garden Fertilizer 8-10-8

Use on vegetables, flowers, trees, shrubs and tomatoes. Ideal tomato food and all Varieties of Vegetables



Item #	Desc	UPC	Vendor	CS/UOS	Location
82280231	20 lb	732221320901	32090	1/1	East

Tomato & Vegetable Food 4-10-6

Provides the proper nutrients necessary to promote vigorous growth, abundant vegetable harvest, and juicy tomatoes.



Item #	Desc	UPC	Vendor	CS/UOS	Location
82280232	4 lb	732221320949	32094	12/12	East

Iron Sulfate

The Iron Sulfate plant supplement is recommended for the prevention and correction of chlorosis. This plant fertilizer helps to give a beautiful green color to lawns, shrubs, flowers and gardens.

Not for sale in AK, HI



Item #	Desc	UPC	Vendor	CS/UOS	Location
82280272	4 lb	732221323407	32340	12/12	East



Magnesium Sulfate

Contains a soluble source of Magnesium that is readily available to aid in correcting plant Chlorosis. Excellent for use on palms. Use to encourage white blooms on Hydrangeas. **Not for sale in HI**

Item #	Desc	UPC	Vendor	CS/UOS	Location
82280189	4 lb	732221216341	21634	12/12	East

Triple Super Phosphate 0-45-0

Concentrated form of super phosphate. Ideal for vigorous plant root growth, sturdy stems, and hastened maturity. Can be used on vegetables, shrubs, flowers, shade, and fruit trees. This concentrated source of readily available phosphorous promotes flower and fruit production and enhances vegetable yields. 2 pounds covers 100 square feet. Analysis: 0-45-0. 4-pound container.

Not for sale in HI

Item #	Desc	UPC	Vendor	CS/UOS	Location
82280263	4 lb	732221322752	32275	12/12	East

Muriate Of Potash 0-0-60

An excellent source of Potassium, which aids plants in forming healthy stems, roots and tuber growth. Great for below ground forming vegetables such as Potatoes, Carrots and others.

Item #	Desc	UPC	Vendor	CS/UOS	Location
82280247	4 lb	732221321458	32145	12/12	East

Soil Sulfur

Designed to increase acidic conditions and to help lower PH in excessively alkaline soils. Great for use on lawns, acid loving ornamentals and vegetables. Allow for 6-8 weeks following application for results and effects to show. **Not for sale in HI**

Item #	Desc	UPC	Vendor	CS/UOS	Location
82280256	4 lb	732221321854	32185	12/12	East

Cottonseed Meal 6-1-1

A natural source of Nitrogen, Phosphate and Potash that helps create an acidic soil condition and aids in production of friendly soil bacteria. **Not for sale in HI**

Item #	Desc	UPC	Vendor	CS/UOS	Location
82280248	3 lb	732221321656	32165	12/12	East

Blood Meal 12-0-0

This plant growth supplement aids in plant productions of top growth and deep green foliage. Provides a slow release form of natural Nitrogen for continues feeding and reducing nitrogen burn. Can be used on Pansies, Roses, flowers, trees, shrubs and vegetables. **Not for sale in HI, WA**

Item #	Desc	UPC	Vendor	CS/UOS	Location
82280245	8 lb	732221321427	32142	4/4	East
82280246	2.75 lb	732221321441	32144	12/12	East

Aluminum Sulfate

Helps create an acid soil condition for plants. Intensifies Blue color in Hydrangeas. Use on Azaleas, Gardenias, Camellias, Rhododendrons, Blueberries and others listed on label.

Not for sale in HI

Item #	Desc	UPC	Vendor	CS/UOS	Location
82280253	4 lb	732221321755	32175	12/12	East

Growers Special 12-6-6

A time-release fertilizer that provides a complete feeding and contains Blue Chip form of Nitrogen. Can be used to feed all plants, even container grown, without burning. **Not for sale in AK, CT, DE, HI, MD, MT, NH, NM, VT, WA, WY**

Item #	Desc	UPC	Vendor	CS/UOS	Location
82280289	4 lb	732221331907	33190	12/12	East

Super Phosphate 0-18-0

Provides a readily available form of phosphate which is used by plants during photosynthesis. This plant growth supplement promotes larger more beautiful blooms & fruit. This phosphate fertilizer can be used on outdoor plants for enhanced growth. **Not for sale in HI**

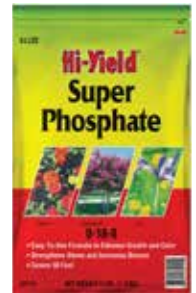

Item #	Desc	UPC	Vendor	CS/UOS	Location
82280236	4 lb	732221321151	32115	12/12	East

Hi-Yield®

Bone Meal 0-10-0

Provides a slow release form of natural Phosphorus to help plant produce sturdy root systems, hastens maturity and stimulates plant growth. For use on bulbs, Roses, flowers and shrubs. Excellent for vegetable gardens.

Product cannot be shipped to (HI, WA)



Item #	Desc	UPC	Vendor	CS/UOS	Location
82280240	4 lb	732221321243	32124	12/12	East
82280239	20 lb	732221321205	32120	1/1	East

Bone & Blood Meal 6-7-0

The Bone & Blood Meal plant food provides a excellent combination of natural Nitrogen and Phosphate. This plant growth supplement is perfect for all flowers, ornamentals, shrubs and vegetables. The plant fertilizer is gentle on plants. Perfect for delicate roses and other flowers. **Product cannot be shipped to (CA, HI, WA)**



Item #	Desc	UPC	Vendor	CS/UOS	Location
82280241	3 lb	732221321267	32126	12/12	East

Fast Acting Lime

Helps to increase the pH of acid soils, while also creating a proper soil environment. The pH supplement will boost effectiveness of fertilizer and increase availability of nutrients. Can be used on lawns, vegetables, flowers and ornamental beds. Can be used any time of the year. **Product cannot be shipped to (AK, HI)**



Item #	Desc	UPC	Vendor	CS/UOS	Location
82280243	4 lb	732221321342	32134	12/12	East
82280242	25 lb	732221321328	32132	1/1	East

Horticultural Hydrated Lime

Corrects soil acidity for shrubs, flowers, vegetables, lawns and house plants. Helps to loosen heavy clay soils and increases soil pH levels providing for better growth of plants. Can be used to keep down odor and flies around stables, outhouses, etc.

Not for sale in HI



Item #	Desc	UPC	Vendor	CS/UOS	Location
82280296	5 lb	732221333710	33371	6/6	East

GROW MORE®



Garden Molasses

Provides a source of carbohydrates & Organics for an enhanced flavorful yield. Improves aroma & taste in fruits, vegetables, & herb gardens.

Item #	Desc	UPC	Vendor	CS/UOS	Location
82570064	1 qt	080986053078	5307	12/12	West

Cactus Juice 1-7-6

Grow More Cactus Juice is a high quality fertilizer for all cacti and succulents with soluble calcium to strengthen plant structure, reduce tissue softness and promote optimal growth.

Item #	Desc	UPC	Vendor	CS/UOS	Location
82570031	16 oz	080986031304	3130	12/12	West

Maxi-Cal 10-0-0

Maxi-cal liquid is a bio-effective formulation that prevents or corrects of physiological calcium and micronutrients deficiencies. Contains 10 percent calcium Plus eight micros. Improves quality of fruits and vegetables.

Item #	Desc	UPC	Vendor	CS/UOS	Location
82570034	16 oz	080986130014	13001	12/12	West

Bonsai Nutrient Blend 1-1-1

Recommended for all container grown Bonsai, and native soil grown specimen plants. Our formula utilizes traditional slow acting organic nutrients, Blood Meal, Bone Meal, and Barley Meal. Low analysis formula designed to keep good color on foliage and eliminate loose spindly growth. Concentrated, makes 48 Gallons. Derived from Blood, Bone, and Barley Meals.

Item #	Desc	UPC	Vendor	CS/UOS	Location
82570036	8 oz	080986053719	5371	12/12	West

Lucky Bamboo 2-2-2

Designed for Dracaena Sandrine growing in containers. For indoor and outdoor usage.

Item #	Desc	UPC	Vendor	CS/UOS	Location
82570033	8 oz	080986078576	7857	12/12	West



Stump Remover 13-0-44

Use as a fertilizer or stump remover. Helps maintain pink color of Hydrangea grown in acidic soil.

Item #	Desc	UPC	Vendor	CS/UOS	Location
82570051	1 lb.	080986074219	7421	12/12	West

Soluble Palm Food 15-5-15

Recommended for all varieties of cycades and palms. A 3-1-3 ratio with extra Mn and Mg to correct frizzletop and yellow leaves in all palms. Developed by dr. Timothy Borschat, professor at University of Florida to correct common palm tree deficiencies. Dissolve 1-2 tablespoons per gallon of water for soil drench. Apply during the growing season (warm summer months). Also contains chelated micronutrients water palms before applying fertilizer.

Item #	Desc	UPC	Vendor	CS/UOS	Location
82570003	1.5 lb.	080986051074	5107	12/12	West
82570007	3 lb.	080986051029	5102	6/6	West

Sea Grow All Purpose 16-16-16

Sea Grow All Purpose 16-16-16 is a hybrid blend of botanical seaweed extract, blood meal, organic carbon, amino acids, carbohydrates, primary N-P-K plant foods, yucca extract and micronutrients. Provides a Bio-Stimulant effect from seaweed promotes vigorous growth, better quality fruits and abundant blooms with better keeping and storage qualities. Recommended for indoor or outdoor growing situations, container plants or field grown plants using native soil and artificial mixes.

Item #	Desc	UPC	Vendor	CS/UOS	Location
82570016	1.5 lb.	080986060908	6090	12/12	West
82570018	3 lb.	080986081828	8182	12/12	West

Sea Grow Flower & Bloom 4-26-26

A hybrid blend of botanical seaweed extract, blood meal, organic carbon, amino acids, carbohydrates, primary N-P-K plant foods, yucca extract and micronutrients. Biostimulant effect from seaweed promotes vigorous growth, better quality fruits and abundant blooms with better keeping and storage qualities. Recommended for indoor or outdoor growing situation, container plants or field grown plants using native soil and artificial mixes.

Item #	Desc	UPC	Vendor	CS/UOS	Location
82570017	1.5 lb.	080986060618	6061	12/12	West
82570019	3 lb.	080986081842	8184	12/12	West

Tomato Food 18-18-21

This tomato food has special formula for all tomatoes with extra magnesium and higher potash ratio for firmer fruit and yields. No matter what type of tomatoes you love, from cherry to beefsteak, this food will produce the most flavorful, plump tomatoes every time. Potassium nitrate base instead of a potassium chloride base. Uses all EDTA micronutrients including copper and zinc, while others use sulfates.

Item #	Desc	UPC	Vendor	CS/UOS	Location
82570005	1.5 lb	080986052361	5236	12/12	West

Super Bloomer 15-30-15

Designed to promote abundant blooms and vibrant flowers, this water-soluble fertilizer provides a balanced mix of nitrogen, phosphorus, and potassium. The higher phosphorus content stimulates flower production, while the balanced nutrient ratio supports overall plant health and vigor. Simply mix the concentrate with water as directed and apply to your plants for impressive blooming results. With Grow More Super Bloomer, you'll enjoy a colorful and flourishing garden.

Item #	Desc	UPC	Vendor	CS/UOS	Location
82570013	1.5 lb.	080986074189	7418	12/12	West
82570014	3 lb.	080986074158	7415	6/6	West
82570015	5 lb. bag	080986074141	7414	6/6	West

Citrus Food 20-10-15

Properly timed foliar or soil application of this citrus food can help improve fruit color, firmness and earlier maturity. Helps trees respond with improved vigor, foliage color and helps reduce alternate year bearing tendencies. Chelated micronutrients. For use on all citrus including orange, lemon, grapefruit, tangerine, limes and tangelo. 20-10-15 Formulation. Available in 1.5-pound pack.

Item #	Desc	UPC	Vendor	CS/UOS	Location
82570004	1.5 lb	080986086106	5260	12/12	West

Hydrangea Blueing Formula

Hydrangea bluing formula. Aluminum sulfate. Helps form acid soil for all hydrangea. Turns pink flowers blue. Pink and red forms often turn blue or purple in acid soils. Use for shrub, climbing vine, bug leaf garden and common varieties. Also used for azaleas, camellias, gardenias, fuchsias, begonias, rhododendrons.

Item #	Desc	UPC	Vendor	CS/UOS	Location
82570041	2 lb.	080986075391	7539	12/12	West

2024

Orchid Food 30-10-10

Grow More Orchid Growth 30-10-10 is great for all orchids during the growing season. It feeds through leaves and roots stimulating bud formation and root development. No harmful chlorides or sodium.



Item #	Desc	UPC	Vendor	CS/UOS	Location
82570029	10 oz	080986138133	13813	12/12	West
82570025	15 oz	080986053603	5360	12/12	West

Orchid Urea Free Growth Food 20-10-20

This premium orchid fertilizer is urea free, good nitrogen availability under wide range of temperature and climate conditions. Water soluble feedings, regularly result in many blooms, healthy, long lived Orchids. 20-10-20 Formulation. Available in 1.25-pound jar.



Item #	Desc	UPC	Vendor	CS/UOS	Location
82570027	10 oz	080986105272	5271	12/12	West
82570023	1.25 lb	080986052705	5270	12/12	West

Orchid Food Fertilizer 20-20-20

Use Grow More 20-20-20 as a general purpose, all-year-round feed for all sorts of orchids: such as Cattleyas, Vandas and Dendrobiums and other orchids. Recommended for slab-mounted epiphytic orchids, those with exposed root systems, as well as terrestrial orchids in soil-based potting mixtures.



Item #	Desc	UPC	Vendor	CS/UOS	Location
82570028	10 oz	080986053993	5399	12/12	West
82570024	1.25 lb	080986051210	5121	12/12	West

Orchid Bloom Formula Fertilizer 6-30-30

Grow More Orchid Bloom is specially designed plant food with a high phosphate to nitrogen ratio that helps improve bud set and increases the size and color of blooms. No harmful chlorides or sodium..



Item #	Desc	UPC	Vendor	CS/UOS	Location
82570026	10 oz	080986038143	13814	12/12	West
82570020	1.25 lb	080986051203	5120	12/12	West

Herb Food 5-1-5

Grow More Herb Food is a slow release, all natural fertilizer specially designed for annual and perennial herbs. It helps enhance the natural oils and flavors for a thriving herb garden.



Item #	Desc	UPC	Vendor	CS/UOS	Location
82570063	1 lb	080986060601	6060	12/12	West

Bromeliad Tillandsia Food 17-8-22

Bromeliad; Tillandsia food; Premium quality; Use indoor or outdoor for showy flowers in branched leaf clusters and handsomely marked flower clusters; 17-8-22



Item #	Desc	UPC	Vendor	CS/UOS	Location
82570030	10 oz	080986138102	13810	12/12	West
82570021	1.25 lb	080986051180	5118	12/12	West

Indoor & Outdoor Food 20-6-16

Grow More Indoor / Outdoor Plant Food 20-6-16 is a specially formulated plant food that will provide complete nutrients to your plants. It has a combination of Urea-free formula which includes calcium, sulfur, magnesium, and other essential micronutrients. This Indoor/Outdoor plant food comes in a 1.25-pound jar and has a high nitrogen ratio to help boost stem and leaf growth.



Item #	Desc	UPC	Vendor	CS/UOS	Location
82570022	1.25 oz	080986075094	18010	12/12	West

Rapid Root #3

IBA root powder. EPA registered cloning powder. 1 ounce of Rapid Root powder will treat approximately 1500 cuttings. Our one dip treatment powder prevents cross contamination problem associated with liquid products. University tested system that parallels nature's own root forming hormone.



Item #	Desc	UPC	Vendor	CS/UOS	Location
82570047	2 oz	080986039980	3998	12/12	West

Hawaiian Bud & Bloom 5-50-17

Don't let your plants down! They'll grow, bloom and thrive better with this top-quality, balanced food. Easy-to-use, instant water-soluble concentrate. Economical too!



Item #	Desc	UPC	Vendor	CS/UOS	Location
82570009	1.5 lb	080986075056	7505	12/12	West
82570010	3 lb	080986075445	7544	12/12	West

Citrus Grower Blend 1.7-0-0

Citrus grower blend fertilizer with chelated micronutrients that provide a readily available source of chelated zinc manganese and copper.



Item #	Desc	UPC	Vendor	CS/UOS	Location
82570042	10 oz	080986080852	8085	12/12	West
82570043	20 oz	080986080869	8086	12/12	West
82570044	15 lb		8088	1/1	West

Soil Acidifier 30-10-10

Grow More Soil Acidifier 30-10-10 is an effective soil acidifier that will help acidify or lower the pH of the soil. It contains chelated micronutrients, soil penetrant, and trace elements that's ideal to use with acid-loving plants that grows in alkaline soil such as azaleas, gardenias, roses, hydrangeas, evergreens, camellias, rhododendrons, junipers, etc. It is used to correct the alkaline soil's problem and helps prevent yellow plant anemia.



Item #	Desc	UPC	Vendor	CS/UOS	Location
82570002	1.5 lb	080986074127	7419	12/12	West
82570006	3 lb		7411	6/6	West

Eco Pond Clear

Eco Pond Clear by Grow More, an all natural algae control for both slime and greenwater types of algae. All natural bacterial product, harmless to fish and plants may be used in new or established ponds.



Item #	Desc	UPC	Vendor	CS/UOS	Location
82570037	10 oz		15102	12/12	West

All Seasons 20-20-20

Recommended for all varieties of cycades and palms. A 3-1-3 ratio with extra Mn and Mg to correct frizzle top and yellow leaves in all palms. Developed by dr. Timothy Borschat, professor at University of Florida to correct common palm tree deficiencies. Dissolve 1-2 tablespoons per gallon of water for soil drench. Apply during the growing season (warm summer months). Also contains chelated micronutrients water palms before applying fertilizer.



Item #	Desc	UPC	Vendor	CS/UOS	Location
82570001	1.5 lb.	080986075063	7506	12/12	West
82570008	5 lb.	080986052941	7431	6/6	West

Organic Iron Chelate Concentrate

Grow More Iron Chelate can be used as a soil application on all types of plants and may be applied in combination with other fertilizers. Powder formulation.



Item #	Desc	UPC	Vendor	CS/UOS	Location
82570045	8 oz	080986077005	7450	12/12	West

Siphon Mixer Injector

The easy-to-use Siphon Mixer is a great way to apply concentrated water-soluble fertilizers, fungicides, and insecticides through a garden hose. The Siphon Mixer connects directly to a hose bib and the powerful vacuum action siphons distillates at a 1:16 gallon ratio. No-clog unit features a back-flow check valve and is fit for permanent installation.



Item #	Desc	UPC	Vendor	CS/UOS	Location
82570052	5x1 pack	080986180057	18005	5/5	West

Magnum Rose Food 8-10-8

Magnum rose food is a complete one-step water-soluble fertilizer with chelated micronutrients and a soil penetrant. Manufactured to the highest quality available. Design is stylish and innovative. Satisfaction is ensured with this product. Formulated for all types of roses.



Item #	Desc	UPC	Vendor	CS/UOS	Location
82570011	1.5 lb	080986130151	13015	12/12	West
82570012	3 lb	080986030147	13014	12/12	West

GROW MORE®

Seaweed Extract

Grow more seaweed extract is liquefied organic kelp. Cold water processed to preserve minerals. Promotes plant growth and a vigorous root system. Foliar feed, root dip or soil drench.



Item #	Desc	UPC	Vendor	CS/UOS	Location
82570060	1 pt	080986060243	6024	12/12	West
82570061	1 qt	080986060489	6048	12/12	West
82570062	1 gal	080986060410	6041	4/4	West

Wet Soil Penetrant

EZ wet soil penetrant. -Can be used on any soil. -Promotes a deeper root system. -Helps move excess salt away from the root zone. - Non-ionic and has a neutral ph. -Helps alleviate dry spots and soil compaction problems. -Regular use will promote a deeper root system. -Leach excess salts away from the root zone, alleviate nun-off, erosion.



Item #	Desc	UPC	Vendor	CS/UOS	Location
82570049	1 qt	080986080555	8055	12/12	West
82570050	1 gal	080986080166	8016	4/4	West

Grow Vite 16-4-2

Grow More Grow-vite is an all purpose fertilizer with chelated iron, zinc, manganese and a special soil penetrant to help ensure these essential nutrients will be readily available to the roots and plant foliage. Ideal for lawns, flowers and vegetables.



Item #	Desc	UPC	Vendor	CS/UOS	Location
82570032	1 gal	080986076602	7549	4/4	West

Jump Start

Grow More Jump Start contains a unique combination of amino acids, micronutrient, vitamins & growth factors in the formula which help your plants thrive while accelerating leaf, stem & root growth.



Item #	Desc	UPC	Vendor	CS/UOS	Location
82570054	1 qt	080986074363	7436	12/12	West
82570055	1 gal	080986074379	7437	4/4	West

GREENVIEW®

All-Purpose 10-10-10

General purpose fertilizer. Provides sustained feeding with a balanced nutrient supply. Excellent for use on trees, shrubs, vegetables, flowers, and ornamental gardens. Ideal for use with newly seeded lawns.



Item #	Desc	UPC	Vendor	CS/UOS	Location
80350053	40 lb.	88685301926	21-30192	40/1	East

Garden Food 5-10-5

A general purpose granular fertilizer. Recommended for flowers, shrubs, and ornamentals. Helps produce strong vigorous root systems and sturdy plants. Non-acid forming formulation.



Item #	Desc	UPC	Vendor	CS/UOS	Location
80350062	40 lb.	88685400421	21-40042	40/1	East



Coop Poop™

Aerobically Composted Chicken Manure: An all-natural, slow-release, non-burning organic blend rich in humates, carbohydrates and trace minerals, which naturally enhances any soil type and promotes plant quality.



Item #	Desc	UPC	Vendor	CS/UOS	Location
81350052	1 lb.	855161009597	HGR 243 CP 1	6/6	East
81350006	6 lb.	855161002048	HGR 243 CP 6	6/6	East
81350004	25 lb.	855161002024	HGR 243 CP 25	1/1	East
81350005	40 lb.	855161002031	HGR 243 CP 40	1/1	East

Worm Castings

Increases beneficial microbial activity and enhances the soil. Provides faster growth, larger plants, and bigger yields.



Item #	Desc	UPC	Vendor	CS/UOS	Location
81350022	15 lb.	855161002512	HGR WC15	1/1	East



Tomato Food 5-10-10

Satisfies heavy feeding requirements of tomatoes. Helps establish new plants quickly and can be used on all garden vegetables.



Item #	Desc	UPC	Vendor	CS/UOS	Location
80070084	4 lb.	071605270044	27004	10/10	East

Bone Meal 4-12-0

All Natural Organic Bone Meal promotes superior plant growth and beautiful blooms. Slow release nitrogen feeding for all bulbs, flowering shrubs and perennials.



Item #	Desc	UPC	Vendor	CS/UOS	Location
80070053	3 1/2 lb.	071605202038	20203	12/12	East

Dried Blood 12-0-0

An all natural organic supplemental high-nitrogen plant food. Greens up yellowing leaves and promotes foliage growth. Long-lasting, even feeding of nitrogen. Excellent for all leafy plants and vegetables, especially lettuce, cabbage and swiss chard.

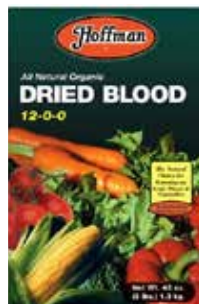

Item #	Desc	UPC	Vendor	CS/UOS	Location
80070055	3 lb.	071605216035	21603	10/10	East

Purely Organic Plant Food 4-2-3

All purpose garden & flower food, certified organic poultry manure based. No chemicals or contaminants, safe to use around people and animals. Produces outstanding results in flower and vegetable gardens and lawns.



Item #	Desc	UPC	Vendor	CS/UOS	Location
80070066	4 lb.	071605200041	20004	12/12	East
80070067	10 lb.	071605200102	20010	5/5	East



All Purpose 20-20-20

More professional growers have used this product for all their growing needs than any other formula. It is a balanced blend of Nitrogen, Phosphorus and Potassium with fully chelated trace elements that works on all plant materials as a general-purpose fertilizer. Indoors it is especially effective on foliage plants to keep leaves green and happy.



Item #	Desc	UPC	Vendor	CS/UOS	Location
80060003	8 oz.	671341520085	52008	12/12	National
80060002	1 1/2 lb.	671341520245	52024	12/12	National
80060011	4 lb.	671341520641	52064	6/6	National
80060018	10 lb.	671341520108	52010	1/1	National
80060033	350 sample packets	671341999997	70000	1/1	National

Orchid Special 30-10-10

High Nitrogen balance for orchids grown in fir bark. Feeds through both the roots and the leaves to ensure the development of new leaves. Designed to prevent nitrogen drawdown from the decomposition of the orchid fir bark growing material.



Item #	Desc	UPC	Vendor	CS/UOS	Location
80060010	8 oz.	671341530084	53008	12/12	National

Houseplant Special 15-30-15

Designed for use on all foliage and flowering plants. This formula has had much success over 60 years since its original design - the classic nutrient blend produces long-term green lush growth.



Item #	Desc	UPC	Vendor	CS/UOS	Location
80060007	8 oz.	671341515081	51508	12/12	National

African Violet 12-36-14

This 12-36-14 plant food has been a favorite of commercial African Violet growers for over 30 years. Perfect to maximize flower count, size and bright color on standard African Violet varieties.



Item #	Desc	UPC	Vendor	CS/UOS	Location
80060001	8 oz.	671341512080	51208	12/12	National



Hydrangea Blue 7-3-3

Unlike other blue enhancers, we have kept the standards you have come to trust in the Peters family name. We have designed this unique formula to not just keep your hydrangeas blue BUT to provide them with the nutrients they need for strong growth and well-being.

Item #	Desc	UPC	Vendor	CS/UOS	Location
80060030	1.5 lb.	671341593249	59324	12/12	National

Palm Food 16-5-25

A blend of essential nutrients designed for the unique requirements of palms. Formulated to prevent the build up of harmful salts while delivering additional potassium, magnesium, sulfur and micro nutrients. Jack's Classic Palm Food produces lush green leaves & strong growth in both pots and landscapes.

Item #	Desc	UPC	Vendor	CS/UOS	Location
80060016	1.5 lb.	671341516248	51624	12/12	National

Citrus FeED 20-10-20

Citrus FeED 20-10-20 is designed to provide the optimum combination of nutrients needed by plants in the citrus group. This formula with enhanced micronutrient levels will produce vibrant green leaves, strong branches and more fruit.

Item #	Desc	UPC	Vendor	CS/UOS	Location
80060019	1.5 lb.	671341525240	52524	12/12	National

Acid Special 17-6-6

Very effective in reducing the soil pH, which keeps iron and other trace elements available to the plant. In plantings next to the concrete foundations of the home, where the pH is elevated, it will keep the leaves green and healthy, promoting lush vegetative growth and better blooms. This formula contains elevated levels of iron and sulfur which most of the acid loving plants require.

Item #	Desc	UPC	Vendor	CS/UOS	Location
80060017	1.5 lb.	671341517245	51724	12/12	National
80060043	4 lb.	671341517641	51764	6/6	National

Tomato FeED 12-15-30

For all tomatoes and blooming vegetable varieties. Includes calcium to help prevent blossom end rot.

Item #	Desc	UPC	Vendor	CS/UOS	Location
80060042	1 1/2 lb.	671341513247	51324	12/12	National

Blossom Booster 10-30-20

Professional formula for more flowers and brighter colors on all outdoor and indoor plants. Includes minor nutrients, too. Plastic Tub with 100% Waterproof labeling.

Item #	Desc	UPC	Vendor	CS/UOS	Location
80060006	8 oz.	671341510086	51008	12/12	National
80060005	1 1/2 lb.	671341510246	51024	12/12	National
80060004	4 lb.	671341510642	51064	6/6	National
80060014	10 lb.	671341510109	51010	1/1	National

Petunia FeED 20-6-22

Specially formulated for iron hungry crops such as petunia, calibrachoa, bacopa, nemesia, diascia, scaevola and others! Feeds through both the roots and the leaves.

Item #	Desc	UPC	Vendor	CS/UOS	Location
80060021	1 1/2 lb.	671341526247	52624	12/12	National
80060038	4 lb.	671341526643	52664	6/6	National
80060020	10 lb.	671341526100	52610	1/1	National
80060037	350 sample pkts	671341700043	70004	1/1	National

ClassiCote™ with Crystal Green® 15-8-23

A time release fertilizer perfect for both indoor and outdoor planting. Jack's Crystal Green formula provides plants with a quick green up, while the time release fertilizer feeds for up to four months.



Item #	Desc	UPC	Vendor	CS/UOS	Location
80060054	2 lb	671341540328	54032	12/12	National
80060055	4 lb	671341540045	54004	6/6	National
80060041	25 lb bag	671341540250	54025	1/1	National
80060034	200 sample packets	671341700014	70001	1/1	National



Orchid Bloom Booster Liquid 3-9-6

This product is easy to mix and use. Orchid Bloom Booster contains not only major and minor elements but also calcium and magnesium, which is essential when using rain water, reverse osmosis water and relatively pure waters for growing. When used in conjunction with the Jack's Classic Orchid 7-5-6, it is the perfect system to keep your orchids producing excellent leaves and blooms throughout the year.

Item #	Desc	UPC	Vendor	CS/UOS	Location
80060008	8 oz.	671341503088	50308	12/12	National

Orchid Liquid 7-5-6

Easy to mix and use and contains not only major and minor elements but also Calcium and Magnesium, which is essential when using rain water, reverse osmosis water, and relatively pure waters for growing. When used in conjunction with the Jack's Classic Orchid Bloom Booster 3-9-6, it is the perfect system to keep your orchids producing excellent leaves and blooms throughout the year.

Item #	Desc	UPC	Vendor	CS/UOS	Location
80060009	8 oz.	671341507086	50708	12/12	National



Outdoor Fertilizer Spikes

Outdoor spikes specially formulated for specific plant needs. Easy way to feed plants all season long. Waterproof packaging with bold graphics for cross-merchandising in outdoor live plant area.

Item #	Desc	UPC	Vendor	CS/UOS	Location
80180348	A Organic Tree & Shrub 8pk	073035012102	1210	12/12	National
80180133	Tree 9pk	073035013109	1310	12/12	National
80180136	B Evergreen 9pk	073035013116	1311	12/12	National
80180019	C Tree & Shrub 5pk	073035010009	1000	12/12	National
80180021	D Fruit & Citrus 5pk	073035010023	1002	12/12	National

Tomato Fertilizer Spikes 6-18-6

For beautiful, healthy, juicy and big tomatoes. Special formula does the job from the roots up. Feeds for 8 weeks.



Item #	Desc	UPC	Vendor	CS/UOS	Location
80180026	18pack w/ clipstrip	073035060059	6005	24/24	National
80180147	Shelf Blister 18pack	073035060486	6000	12/12	National

Rose Fertilizer Spikes 9-12-9

Give your rose bushes the extra nourishment they crave with Jobe's Fertilizer Spikes for Roses. Unlike surface fertilizers that can wash away with rain or watering, Jobe's works underground at the plants roots, providing heightened growing power and healthy blooms that create a focal point for your home landscape.



Item #	Desc	UPC	Vendor	CS/UOS	Location
80180025	10 Pack	073035040020	4102	12/12	National

Tree Spikes

Easy to insert around the tree's dripline, the slow-release formula lasts all season. The pre-measured spikes make fertilizing easy with no measuring, hazardous chemicals or smells. Bag of 5.



Item #	Desc	UPC	Vendor	CS/UOS	Location
80180140	Tree	73035020107	2010	32/32	National
80180141	Evergreen	73035020114	2011	32/32	National
80180142	Fruit Tree	073035020121	2012	32/32	National

Bulk Fertilizer Tree Stakes

Jobe's® Fertilizer Spikes ensure a continuous supply of nutrients below the surface, where the trees' active roots are growing. Jobe's Spikes are easy to insert around each tree's dripline, and the slow-release formula lasts all season. No wasteful runoff, no mess, hazards or smells – only a safe beautiful yard. 160/ bulk stakes per case

Item #	Desc	UPC	Vendor	CS/UOS	Location
80180376	Tree & Shrub	073035026109	2610	160/160	National
80180377	Evergreen	073035026116	2611	160/160	National
80180378	Fruit & Citrus	073035026123	2612	160/160	National



Start 0-2-0

Liquinox Start Vitamin B1 (0-2-0) Transplant Solution Is A Growth-promoting Substance That Includes Vitamin B-1, Yucca Extract Base, Chelated Iron And Phosphoric Acid. Start Is Specifically Formulated To Help Reduce Transplant Shock And To Stimulate Feeder Root Growth. In Addition, Start Is An Effective Transplant Solution For Use On All Types Of Transplants. Light And Frequent Applications Of Start Will Result In Good, Healthy Root Structure And A Successful Planting.



Item #	Desc	UPC	Vendor	CS/UOS	Location
82610006	1 qt	011578020321	2032	12/12	West
82610007	1 gal	011578021281	2128	4/4	West

Bloom 0-10-0

Liquinox Bloom is a non-nitrogen formula created especially for flowers, fruits and vegetables. Excellent for plants that require greater acid concentration and as a winter food. Contains a wetting agent (yucca extract base) that helps loosen soils and aids in water penetration. Good on all flowers during budding and blooming periods. Helps toughen plants to withstand extreme climates.



Item #	Desc	UPC	Vendor	CS/UOS	Location
82610004	1 qt	011578010322	1032	12/12	West
82610005	1 gal	011578011282	1028	4/4	West

Fish Fertilizer 5-1-1

Liquinox Fish (5-1-1) is a fertilizer that may be used as a soil drench (applied directly to the soil) or foliar fed (applied directly to the leaves.) This product is safe and non-burning for use on vegetables, flowers, shrubs, lawns, and trees. May be used in garden all year long.



Item #	Desc	UPC	Vendor	CS/UOS	Location
82610012	1 qt	011578070326	7032	12/12	West
82610013	1 gal	011578071286	7128	4/4	West

Western State

Liquinox Western States Vitamin B1 4ea/1gal!For root growth and transplants. Active Ingredients: Iron, Manganese, Zinc Manufactured in United States.



Item #	Desc	UPC	Vendor	CS/UOS	Location
82610010	1 qt	011578060327	6032	12/12	West
82610011	1 gal	011578061287	6128	4/4	West

Iron & Zinc Fertilizer

Liquinox Iron + Zinc (0.1FE 0.1ZN) is an essential blend of fully chelated iron and zinc, which is designed for correction of chlorosis (yellowing leaves). This fully chelated solution does not contain sulfates and is an excellent product for achieving a dark green look.



Item #	Desc	UPC	Vendor	CS/UOS	Location
82610008	1 qt	011578030320	3032	12/12	West
82610009	1 gal	011578031280	3128	4/4	West

Citrus & Avocado Food 6-9-6

Use Liquinox Citrus & Avocado Food 6-9-6 as an excellent acid plant food designed to aid producing good, healthy solid fruit. Liquinox Citrus & Avocado Food 6-9-6 has been especially formulated for the avocado and citrus industry. This product has been tried and proven since 1944 and, will result in good firm fruit.



Item #	Desc	UPC	Vendor	CS/UOS	Location
82610014	1 qt	011578050328	5032	12/12	West

Grow + 8-0-0

Grow Plus is a calcium based fertilizer great for all plants in your yard and landscape. Calcium plays a important function in plant uptake. Builds strong cell walls and increases plant vitality calcium plays a critical role in soil balance and soil salinity and IMPROVES WATER PENETRATION. Every plant need calcium to grow and will help reduce plant stress. apply every two weeks all year long for beautiful landscape



Item #	Desc	UPC	Vendor	CS/UOS	Location
82610015	1 gal	011578101297	10129	4/4	West



Grow 10-10-5

Liquinox Grow (10-10-5) is a concentrated all purpose fertilizer specifically formulated for use on all types of indoor and outdoor plants. Grow encourages all year round growth. It is an excellent plant food for anything that you want to grow! The Nitrogen increases foliage color, stem growth and helps plants keep their vibrant colors. Phosphates encourage root growth, hasten maturity and increase plant hardiness.



Item #	Desc	UPC	Vendor	CS/UOS	Location
82610002	1 qt	011578101327	132	12/12	West
82610003	1 gal	011578101280	128	4/4	West



Dial Compost Thermometer

Rapitest soil thermometers are a must have tool for determining soil temperature when planting in early season or transplanting. Classic, Dial and Digital varieties are available along with a compost thermometer for use when composting.



Item #	Desc	UPC	Vendor	CS/UOS	Location
80140038	6.5"	035307016300	1630	6/6	National
80140039	19"	035307016355	1635	6/6	National



Moisture Tester

Instantly tells you when to water plants, prevents over watering, ideal for plants grown in window boxes, hanging baskets & growbags.

Item #	Desc	UPC	Vendor	CS/UOS	Location
80140049	1 Meter	03530718106	1810	12/12	National

4-IN-1 Tester

Helps to provide a healthy growing environment by indicating levels of sunlight, fertility, soil moisture, and soil alkalinity/acidity. No batteries are required.

Item #	Desc	UPC	Vendor	CS/UOS	Location
80140052	1 Meter	3530718182	1818-6	6/6	National

Soil pH Tester

Tests the acidity of soil quickly and easily with this soil pH tester. Gauge instantly displays from acid to alkaline the soils pH for quick results. Check which plants suit your soil with a reference guide for over 50 plants. Enables you to alter soil conditions. Use for fruits, flowers, shrubs and vegetables. No batteries required for operation.

Item #	Desc	UPC	Vendor	CS/UOS	Location
80140050	1 Meter	03530718151	1815	12/12	National

Rapitest® Digital pH Meter

The slender redesigned meter style provides an easier to read, instant digital read-out. It measures and displays the acidity / alkalinity of garden and container soil. Batteries are required and included. Use for vegetables, flowers, fruits or landscaping plants of all kinds.

Item #	Desc	UPC	Vendor	CS/UOS	Location
80140010	1 Meter	035307018458	1845	12/12	National

Rapitest® Digital Moisture Meter

This sleek updated design offers an instant and easy to read digital format. It checks soil moisture where it counts: at root level. Monitoring a plant's soil moisture level helps prevent over and / or under watering. Batteries required and included. Use for vegetables, flowers, fruits or landscaping plants of all kinds.

Item #	Desc	UPC	Vendor	CS/UOS	Location
80140008	1 Meter	035307018250	1825	12/12	National



Rapitest® Electronic Soil Tester

Determines soil pH and fertility level. Both tests can be completed in about a minute. Requires one AA battery. Complete instructions include how to adjust pH and select appropriate fertilizers according to soil conditions.

Item #	Desc	UPC	Vendor	CS/UOS	Location
80140011	1 Meter	035307018601	1860	6/6	National

Rapitest® Soil pH Meter

Checks which plants suit your soil pH and tells you how to alter soil. A pH performance guide for more than 350 plants is included. Ideal for potted indoor and outdoor plants. Simple readout. No batteries required.

Item #	Desc	UPC	Vendor	CS/UOS	Location
80140009	1 Meter	035307018403	1840	6/6	National

Rapitest® 4-Way Analyzer

Measure four soil moisture indicators at once with this Luster Leaf Rapitest 4-way soil moisture meter. Prevent scorching, overwatering and over fertilizing and ensure the soil moisture/acidity/alkalinity is ideal for whatever you are about to plant. The electronic soil analyzer checks combined soil N-P-K level based on USDA standards and you can toggle between various gauges for instant readings.

Item #	Desc	UPC	Vendor	CS/UOS	Location
80140044	1 Meter	03530718809	1880	3/3	National

Rapitest® Moisture Meter

Determines the moisture level where it matters - at the roots. New meter style with probe on flexible cord. Instantly tells you when to water your plants. Helps prevent over or under watering. Instruction booklet gives individual needs for over 150 plants. No batteries required.

Item #	Desc	UPC	Vendor	CS/UOS	Location
80140007	1 Meter	035307018205	1820	6/6	National

Rapitest® Soil Test Kit

Takes the guess work out of determining whether your soil pH needs adjusting or if nitrogen, phosphorus and potash should be added in the form of fertilizers. Just mix soil and water together, pour off solution into comparator, add one tablet, shake and compare to color chart. It's just that easy. Contains supplies for 40 tests - ten each for pH, nitrogen, phosphorus and potash.

Item #	Desc	UPC	Vendor	CS/UOS	Location
80140001	40 Tests	035307016010	1601	6/6	National
80140213	200 Tests	097395216659	1665	1/1	East

Rapitest® Moisture & Light Meter

Combination meter checks both sunlight and moisture. Instantly measure soil moisture levels and sunlight exposure with this meter. Gauge displays on a scale of 1-10 (dry-wet) and A-H (cloudy-sunny), and tethered stainless steel probe will measure water at the root level. Includes watering needs for over 150 plants. No batteries required for operation.

Item #	Desc	UPC	Vendor	CS/UOS	Location
80140046	1 Meter	035307018304	1830	6/6	East

Rapitest® pH Soil Tester

The ideal test to determine soil acidity/alkalinity. Particularly valuable for adjusting soil conditions for better growing lawns and plants. Just mix soil and water, pour off solution into comparator, add tablet, shake and compare to color chart. Ten pH tests each.

Item #	Desc	UPC	Vendor	CS/UOS	Location
80140004	10 Tests	035307016126	1612	12/12	National

Rapitest® SunCalc Sunlight Calculator

The SunCalc provides gardeners with the ability to maximize plants growing potential by placing them in optimum light conditions. It measures the amount of accumulated light that falls on a specific location. This provides gardeners with the ability to match a plant's nursery tag light requirements (full sun, partial sun, etc.) with the actual light conditions as measured by SunCalc.



Item #	Desc	UPC	Vendor	CS/UOS	Location
80140043	Sunlight Calculator	035307018755	1875	6/6	East



Foli-Cal

Foli-Cal: Liquid calcium formulation based on 10% calcium acetate. Corrects calcium deficiency disorders such as blossom end-rot on tomatoes, peppers, eggplant and bitter pit in apples. Works on vegetables, trees and vine crops.



Item #	Desc	UPC	Vendor	CS/UOS	Location
80820147	RTU 32 oz	022179103993	LG 7198	12/12	West

Sequestar® Iron 6%

Sequestar Iron 6% 3-0-0 is a water-soluble granular form of iron that corrects iron deficiency in plants. It contains Eddha, a top-of-the-line agent in chelating materials. This is highly effective in alkaline soils but can also work in more acidic soil conditions. Soil drenching is the best way of applying this product. The formula is readily available to the plant and can quickly cure chlorosis of even deep-rooted plants. The plants can be treated every 3-4 months at a lower rate.



Item #	Desc	UPC	Vendor	CS/UOS	Location
80820151	4 oz	022179100770	LG 7150	12/12	West

NATURE'S SOURCE™



All Purpose Plant Food 10-4-3

Easy, economical, effective, perfect choice for the time-challenged home gardener looking for a more sustainable plant food. One formulation for everything your customers grow: flowers, trees, shrubs, vegetables and herbs. Concentrated formula is easy to mix and goes a long way - offering a great value. Liquid concentrate containing oilseed extract which is a renewable source of plant nutrition and feeds the soil too. Pathogen free - heavy metals free - GMO free.

Item #	Desc	UPC	Vendor	CS/UOS	Location
80610001	15 oz	615369375401	7540-US	12/12	East
80610002	32 oz	615369375302	7530-US	12/12	East
80610004	64 oz	615369375203	7520-US	6/6	East



Fish-Seaweed Blend 2-3-1

A perfect blend of fish hydrolysate and seaweed. Fish and seaweed are known to build the natural sugar in plants. Flowers and foliage will be stronger and more colorful. Blooms will be more plentiful, fragrant and longer lasting. Great for all plants, indoor and outdoor. Best all-purpose, and #1 seller.



Item #	Desc	UPC	Vendor	CS/UOS	Location
80120011	18 oz.	081435218123	FS118	12/12	National
80120012	36 oz.	081435236127	FS136	12/12	National
80120013	1 gal.	081435240094	FS191	4/4	National
80120014	5 gal.	081435250451	FS150	1/1	National

Hydrolyzed Fish 2-4-1

Organic, highly nutritional protein fertilizer made with naturally occurring enzymes present in fresh north Atlantic fish. Nitrogen, derived from fish protein in the form of amino acids, slowly breaks down into basic compounds when added to soil. Does no biological damage to the soil and will promote the growth of beneficial bacteria. Because no oils or proteins are removed, the nutrients remain in the soil longer.



Item #	Desc	UPC	Vendor	CS/UOS	Location
80120001	18 oz.	081435018129	HF 118	12/12	National
80120002	36 oz.	081435036123	HF 136	12/12	National
80120003	1 gal.	081435040090	HF 191	4/4	National

Seaweed Plant Food 0-0-1

Growth promoting substances (Auxins, Cytokinins, Gibberellins) enhance plant development, color and vigor. Seaweed has also been found to increase plant hardiness and resistance to adverse environmental conditions, such as early frost, extreme heat and lack of moisture. Used as a seed inoculant, seaweed fertilizer increases and accelerates germination, and enhances the rapid development of a healthy root system. Seaweed is an excellent addition to any fertilization program.



Item #	Desc	UPC	Vendor	CS/UOS	Location
80120004	16 oz.	081435118126	SW 118	12/12	National
80120008	32 oz.	081435136120	SW 136	12/12	National
80120009	1 gal.	081435140097	SW 191	4/4	National



Tomato & Veg Formula 2-4-2

This is a perfect complete fertilizer for your tomatoes, vegetables and more. Made from fresh fish, seaweed, molasses, yucca extract and humic acids, this formula was uniquely designed for plants with intense vegetative growth.



Item #	Desc	UPC	Vendor	CS/UOS	Location
80120059	18 oz.	081435718128	TV 118	12/12	National
80120043	36 oz.	081435736122	TV 136	12/12	National

Rose & Flowering Formula 2-6-4

Rose & Flowering fertilizer was uniquely formulated for flowering plants to increase their vigor during flowering and to increase the volume and density of buds that produce healthy, vibrant flowers. Made with fresh fish, molasses, yucca extract, seaweed and humic acids our Rose & Flowering formula will ensure that your plants are healthy and happy, produce lush foliage and maximize their flowering ability!



Item #	Desc	UPC	Vendor	CS/UOS	Location
80120044	36 oz.	081435836129	RF 136	12/12	National

Crab Shell 5-3-0

It is an excellent dry organic source of NPK, calcium (23%) and magnesium (1.33%). Crab shell is high in chitin, which promotes the growth of chitin eating bacteria in the soil. When crab shell is added to the soil it helps to create a hostile environment for the fungus and nematodes by feeding the biological life. It will help eliminate ants, grubs, fungus and root nematodes, because they are all chitin based in structure. Put around plants, crab shell will keep slugs and snails off. It also helps choke out weeds and keep moles, voles, mice, etc from digging up bulbs and root vegetables.



Item #	Desc	UPC	Vendor	CS/UOS	Location
80120006	4 lb.	081435506046	CS 604	6/6	National

Kelp Meal 1-0-2

It is dried and ground Rock Weed (Ascophyllum Nodosum). It is full of trace Minerals, Carbohydrates and Amino Acids, which help create a strong root systems and makes a very healthy plant. It should be tilled in the soil before planting or can be top dressed, incorporated into potting soils, seed beds and composting material. It will add organic matter to your soil and help it retain moisture. Kelp Meal will keep your lawn healthy and green, and shows great results on all plants.



Item #	Desc	UPC	Vendor	CS/UOS	Location
80120005	4 lb.	081435406049	KM 604	6/6	National



Continuous Release Plant Food

Unique 15-7-15 NPK ratio designed specifically by Proven Winners to maximize flowering and plant growth. Feeds plants for 6-months with only one application.



Item #	Desc	UPC	Vendor	CS/UOS	Location
81000003	2 oz Packet	064277800022	3101011.OZ02P	200/200	East
81000002	2 1/2 lb.	064277800251	3101011.LB02.5P	12/12	East

Water Soluble Plant Food

Unique 24-12-17 NPK ratio designed specifically by Proven Winners to maximize flowering and plant growth. Only consumer plant food which includes Iron in the important EDDHA form designed to keep plants green at varying pH ranges.



Item #	Desc	UPC	Vendor	CS/UOS	Location
81000001	2.5 lb.	064277801258	3101010.LB02.5P	12/12	East

HIGH TECH MEDIA FOR HIGH TECH HYDROPONICS

Lettuce, herbs, veggies, cannabis and hemp are all popular hydroponic crops. Inert and stabilized media options are top choices for hydroponic systems. Find the perfect fit for your needs, including products from Grodan, Oasis and Jiffy.





SIMPLE YET SCIENTIFIC

The Plant-Prod MJ™ line of fertilizers was designed to bring our 70 years of experience to the cannabis growers of today. Plant-Prod is excited to provide licensed growers of medical marijuana products that are scientifically optimized, consistent and completely soluble.

Grow 12-8-26

This ideal ratio of nitrogen, phosphorus and potassium promotes optimal growth to ensure a sufficient plant structure to support target yields. The added magnesium ensures no signs of deficiency. Grow contains an enhanced micronutrient package with additional EDDHA iron to ensure efficient uptake at a wide range of pH levels.

Item #	Desc	UPC	Vendor	CS/UOS	Location
81970001	4.4 lb	69889123194	12319	6/6	East

Bloom 10-30-20

This essential formulation is high in phosphorus and moderate in potassium, encouraging full bud set and bud filling. The added magnesium ensures no signs of deficiency. Bloom also contains an enhanced micronutrient package with additional EDDHA iron to ensure efficient uptake at a wide range of pH levels.

Item #	Desc	UPC	Vendor	CS/UOS	Location
81970002	4.4 lb	69889123200	12320	6/6	East

Boost 15-30-15

This highly soluble formulation has a low salt index and contains no sulphates or harmful chlorides, making it a very safe fertilizer for young transplants to initiate rapid root development. When plants are of a sufficient level of maturity or when buds are pea sized, feeding with 15-30-15 provides a boost of phosphorus to promote vigorous bud setting and sizing.

Item #	Desc	UPC	Vendor	CS/UOS	Location
81970003	4.4 lb	069889123217	12321	6/6	East

Spike (CaMg)

The absence of nitrogen, phosphorus and potassium allows the use of this formulation at any stage of production without the risk of encouraging vegetative growth when undesired. Ideal for use with reverse osmosis (RO) or city water when calcium and magnesium levels are usually low. Use should be limited to 2 feedings per week at supplemental rates.

Item #	Desc	UPC	Vendor	CS/UOS	Location
81970004	.77 lb	069889123897	12389	12/12	East

Finisher 4-31-37

This finishing formulation encourages fullness and density. During the last few weeks of production, the elevated potassium supports plant turgidity and disease resistance, while the phosphorus optimizes photosynthesis. The added nitrogen ensures no signs of deficiency. Feed during final weeks of fertilization, followed by clear water prior to harvest.

Item #	Desc	UPC	Vendor	CS/UOS	Location
81970005	4.4 lb	069889123231	12323	6/6	East



Anti Transpirant

The safe way to reduce moisture loss when plants are under water stress due to winter kill, windburn, transplant shock and drought. Dries to form a clear and flexible protective coating. Organic, biodegradable, non-toxic and non-hazardous. Wilt-Pruf creates multiple layers of protection which provides the longest lasting (3 to 4 months in winter and 1 to 2 months in summer) film forming polymer.

Item #	Desc	UPC	Vendor	CS/UOS	Location
80380001	32 oz. RTU	035951070000	WILT-PRUF 07000	12/12	National
80380002	16 oz. Con.	035951070079	WILT-PRUF 07007	12/12	National
80380003	32 oz. Con.	035951070093	WILT-PRUF 07009	12/12	National
80380004	1 gal. Con.	035951070116	WILT-PRUF 07011	4/1	National
80380005	5 gal.	035951070130	WILT-PRUF 07013	1/1	East
80380006	55 gal.	035951070178	07017	1/1	East



Plant Food Plus™ 10-15-10

Liquid plant food feeds both indoor and outdoor plants. Provides vital micronutrients every time and encourages new plant growth.



Item #	Desc	UPC	Vendor	CS/UOS	Location
80050065	32 oz.	089146901099	SPF45180	8/8	National

All Purpose Extended Feed Plant Food 19-6-12

Great for all indoor and outdoor plants. Feeds continuously for up to 6 months. The slow release of nutrients virtually eliminates the chance of overfeeding. Instead, your plants get the nutrition they need when they need it.



Item #	Desc	UPC	Vendor	CS/UOS	Location
80050075	1 lb	089146901112	SPF48790	12/12	National
80050076	2 lb	089146900986	SPF48800	6/6	National

All Purpose Slow Release Plant Food 16-12-12

Granular plant food for flowers, vegetables, and gardens. Easy-to-use slow-release formula that feeds up to 3 months.



Item #	Desc	UPC	Vendor	CS/UOS	Location
80050078	3.5 lb	089146900887	SPF48640	6/6	National

Flower & Vegetable Extended Feed Plant Food 13-13-13

Contains slow-release nutrients your garden needs. Feeds flowers, fruits, and vegetables up to 6 months.



Item #	Desc	UPC	Vendor	CS/UOS	Location
80050077	2 lb	089146900955	SPF48300	6/6	National

Orchid Food 20-20-15

Helps grow healthier and more beautiful Orchids. Water soluble formula that contains vital micronutrients.



Item #	Desc	UPC	Vendor	CS/UOS	Location
80050067	10 oz	089146900993	SPF70600	12/12	National



Compost Tea Bags 4-6-4

All Natural. Designed for the avid organic gardener. This permeable fertilizer pack can be left to steep in a watering can overnight to make a Compost Tea brew for topical application.



Item #	Desc	UPC	Vendor	CS/UOS	Location
80950005	12 Bags/unit	031417001076	80-20-2005	10/10	East

4-6-4 Natural Organic Flower & Vegetable Plant Food

Promotes a rapid rate of vegetative establishment. Quick ground cover minimizes soil erosion and the need for repairs or re-seeding. Sustane replenishes the soil with a rich supply of humus (stabilized organic matter) and all of the essential nutrients required for quality growth.



Item #	Desc	UPC	Vendor	CS/UOS	Location
80950001	5 lb.	031417000437	80-20-1105	8/8	East
80950002	20 lb.	031417000468	80-20-1121	100/10	East

8-2-4 All Natural Plant Food For Organic Lawns & Landscapes

All Natural Slow Release Nitrogen Fertilizer provides 6 - 12 weeks of nitrogen in the organic slow release form. Sustane replenishes the soil with a rich supply of humus (stabilized organic matter) and all of the essential nutrients required for quality growth. This product provides a combination of plant nutrients and organic substances derived from biologically stable compost plus natural sulfate of potash and feather meal.



Item #	Desc	UPC	Vendor	CS/UOS	Location
80950003	5 lb.	003141700048	80-55-1105	8/8	East

Spring Weed & Feed Corn Gluten 9-0-0

Sustane 9-0-0 with non-GMO corn gluten meal with 15% Sustain fertilizer that performs as a natural broadleaf weed pre-emergent when used in spring. It is safe, easy to apply, and is blended with slow release nitrogen to help thicken lawns.



Item #	Desc	UPC	Vendor	CS/UOS	Location
80950007	30#	31417000550	80-60-1131	1/1	East

GARDEN ACCESSORIES



CHECK OUT OUR
CLEARANCE ITEMS!

DROP SHIP VENDORS

Esschert Design

FOB Thurmont, MD
\$100 minimum order
Under 3k order, 15% freight. Up to \$4,999 order,
10% freight. Up to \$7,499 order, 5% freight.
\$7,500+ = free freight
Oversized/overweight items are subject to
additional freight charges
20% restocking Fee

Land & Sea

FOB Thurmont, MD
\$100 minimum order
Under 3k order, 15% freight. Up to \$4,999 order,
10% freight. Up to \$7,499 order, 5% freight.
\$7,500+ = freight freight
Oversized/overweight items are subject
to additional
freight charges
20% restocking Fee

Red Carpet Studios

FOB Loveland, Ohio
\$250 minimum for garden catalog
\$150 minimum for fashion and holiday catalog
15% restocking fee

Boost Lifestyle Brands

Prepaid on \$2k order
Flat shipping rate of \$35 on orders less than \$2k

Glow Path

Prepaid on 1 pallet order
Less than Pallet, FOB Waterford, MI

Radians

Prepaid freight \$1,250
Minimum \$100
15 day delivery window



Griffin Greenhouse Retail WAREHOUSE Shipping Map

We are now shipping nationwide!

NATIONAL



2024

Refer to location key:

National items are stocked nationally
 Select items are sold East or West only; no exceptions

8" Kaleidoscope Planter

Premium plastic modular planter can be displayed individually each planter has a removable saucer ideal for succulents or shallow rooted planted.

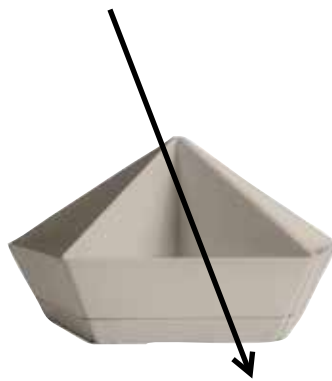

Item #	Desc	UPC	Vendor	CS/UOS	Location
80282643	Vanilla Bisque	770932844170	KDP08000A58	6/6	National

Where is the pricing?

1. Scan QR code on Chapter Pages to see pricing on Griffins.com
2. Contact your Griffin Sales Representative
3. Call into Griffin Customer Service 800.888.0054





Talon Bracket

Mount the brackets on a wall or column for hanging plants or other adornments. These brackets are resistant to all weather types and UV rays.

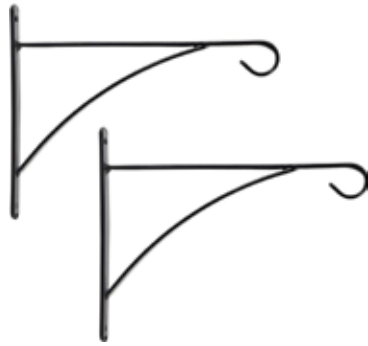

Item #	Desc	UPC	Vendor	CS/UOS	Location
80690162	12"	813001017454	BR05	10/10	East
80690163	16"	813001017461	BR06	10/10	East

FAIRY GARDEN KITS

Easily design a miniature garden scene and step into a world of fantasy. Fairy gardens are miniature gardens complete with structures and living plants limited only by the imagination. These kits include multiple handcrafted pieces and make it easy for children and adults to design unique and delightful gardens.



Tea Party Fairy Garden Kit contains:

- (1) Tea Pot Cottage
- (1) Fairy with Tea
- (1) Tree Trunk Table
- (2) Tree Trunk Chairs
- (3) Lattice Fences
- (1) Welcome Sign
- (1) Tea Set
- (1) Pair Hedgehogs

Item #	Desc	UPC	Vendor	CS/UOS	Location
80690701	Tea Party	849637004735	FG31	12/12	East



Adoring Acorns Fairy Garden Kit contains:

- (1) Acorn House
- (1) Fairy with Acorn Hat
- (1) Acorn Bench
- (3) Log Fences
- (3) Birdhouse Stakes
- (1) Squirrel
- (1) Tree Slab Pathway

Item #	Desc	UPC	Vendor	CS/UOS	Location
80690702	Adoring Acorns	849637004742	FG32	12/12	East



Face of the Forest Planter

Adding elements of fantasy and wonder to an area is easy with this durable planter for trees, walls, or fences. Whether using the whimsical face-shaped planter as a decorative container for growing and displaying live plants, or as a tree spirit embellishment to enrich the imaginative tone of your outdoor space, this functional planter brings a sprinkle of merriment and a hint of tranquility.

Item #	Desc	UPC	Vendor	CS/UOS	Location
80691011	Willow	849637009402	TF01	4/4	East
80691012	Elderberry	849637009419	TF02	4/4	East
80691013	Hawthorn	849637009426	TF03	4/4	East



Emerald Series Lattice Trellis

Made of high-quality metal with a bronze-look finish, this trellis provides necessary plant support and is easy to use.

Item #	Desc	UPC	Vendor	CS/UOS	Location
80690481	4'x10"	813001018475	TR01	5/5	East

Autumn Leaf Trellis

Attractively supports and displays climbing plants, flowers and vines or can even be used alone as a decorative garden accent.

Item #	Desc	UPC	Vendor	CS/UOS	Location
80690486	6'x10"	813001018529	TR06	5/5	East

Phoenix Trellis

The rustic patina on the flower motifs enhances the garden charm of this planting accessory. Count on this trellis for the architectural support your climbing plants need.

Item #	Desc	UPC	Vendor	CS/UOS	Location
80690489	6'x10"	813001018550	TR09	5/5	East



Rain Chain

Enjoy the rain and sounds of falling water with this whimsical Rain Chain. It is designed for easy hanging as a vertical water feature or downspout with a gutter clip at the top of the chain.

Item #	Desc	UPC	Vendor	CS/UOS	Location
80690909	Birds	849637007859	RC05	10/10	East
80690907	Watering Cans	849637006371	RC03	10/10	East

2024



Filigree Plant Stand

Great decorative addition to your home or garden. Finished with a durable matte black weather-proof epoxy coating for long life

Item #	Desc	UPC	Vendor	CS/UOS	Location
82140024	12"H X 14"W	095422001810	FPS	4/4	National
82140025	20"H X 14"W	095422001841	FPST	4/4	National

Hanging Basket w/ Liner



Item #	Desc	UPC	Vendor	CS/UOS	Location
82140207	14" Matte Black	095422000547	HBMB	6/6	National

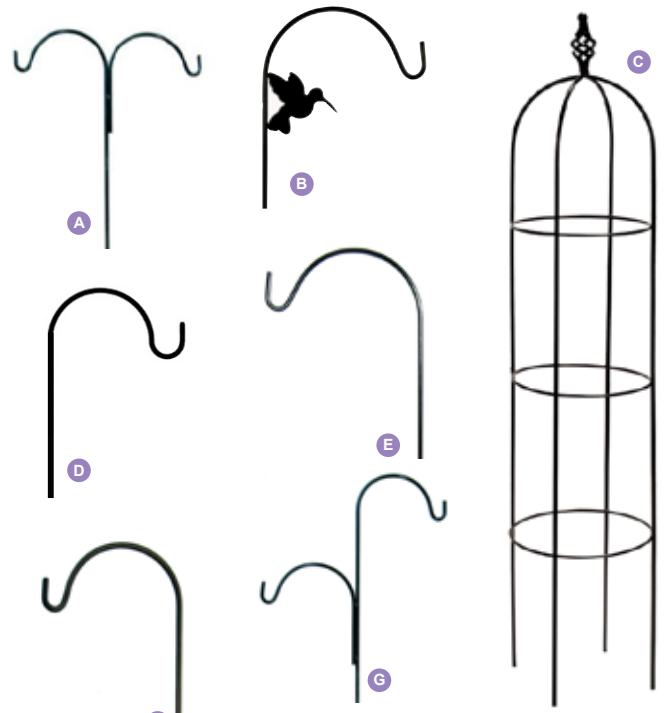

Obelisk with Spiral Twist



Garden Hooks

Item #	Desc	UPC	Vendor	CS/UOS	Location
82140097	A 90" Tall Double	095422000622	TD	10/10	National
82140102	B 65" Tall Floral Basket Hummingbird	095422993634	TFBHHB	10/10	National
82140060	C 54"x10.5"x10.5" Black Obelisk	095422994150	OST	4/4	National
82140061	C 54"x10.5"x10.5" Bronze Obelisk	095422994167	OSTBR	4/4	National
82140059	16 Pc. Obelisk Pallet	095422994518	OCA	1/1	National
82140086	D 65" Short Single	095422000417	SS	10/10	National
82140014	E 45" Floral Basket Feeder Hanger	095422480004	FBH	10/10	National
82140113	F 90" Tall Single	095422000615	TS	10/10	National
82140103	G 90" Tall Offset	095422000639	TOF	10/10	National
82140075	65" Short Offset	095422001438	SOF	10/10	National
82140082	H 90" Square Tall Offset w/ Finial	095422991739	SQTOF	5/5	National
82140089	I 65" Short Single w/ Spiral Twist	095422001469	SSST	5/5	National
82140078	J 65" Short single w/ Finial	095422994662	SQSSF	5/5	National
82140084	90" Tall Single w/Finial	095422991982	SQTSF	5/5	National
82140080	K 90" Tall Double w/Finial	095422994044	SQTDF	5/5	National

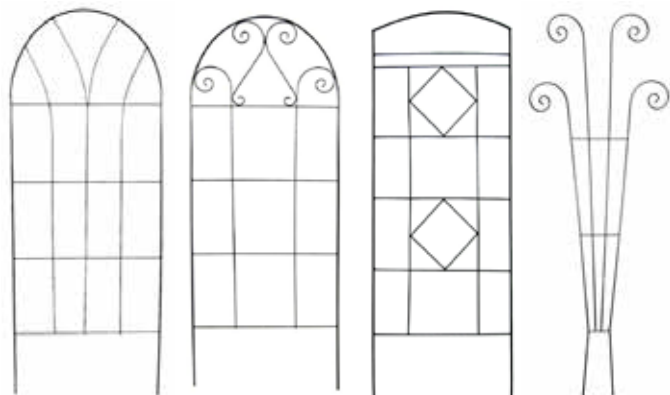

Cathedral Trellis

Item #	Desc	UPC	Vendor	CS/UOS	Location
82140011	65"Hx25"W Black	095422994235	CT	10/10	National
82140012	65"Hx25"W Bronze	095422994242	CTBR	10/10	National

Scroll Trellis

Item #	Desc	UPC	Vendor	CS/UOS	Location
82140068	65"Hx25"W Black	095422994266	SCT	10/10	National
82140069	65"Hx25"W Bronze	095422994273	SCTBR	10/10	National

Arch Trellis

Item #	Desc	UPC	Vendor	CS/UOS	Location
82140001	65"Hx25"W Black	095422994297	AT	10/10	National
82140002	65"Hx25"W Bronze	095422994303	ATBR	10/10	National

Fan Trellis

Item #	Desc	UPC	Vendor	CS/UOS	Location
82140027	60"H x 24"W Black	095422991814	FTM	10/10	National
82140028	60"H x 24"W Bronze	095422991685	FTMBR	10/10	National

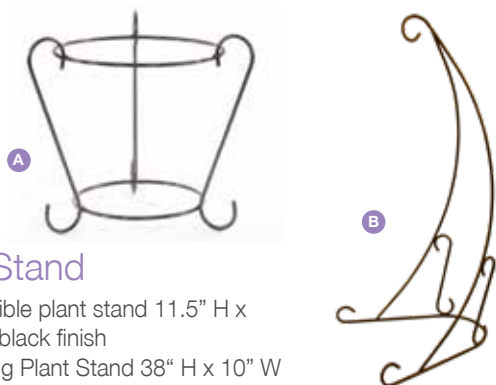

Plant Stand

(A) Reversible plant stand 11.5" H x 12.75" W black finish
 (B) Hanging Plant Stand 38" H x 10" W Bronze finish

Item #	Desc	UPC	Vendor	CS/UOS	Location
82140063	A Black	095422992514	PS-10	5/5	National
82140064	B Bronze	095422991609	PSBR	6/6	National

Wonder GRIP for Kids!

Textured nitrile palm coating on an ultra-lightweight seamless nylon knitted glove in a size for children. Three assorted colors.



Item #	Desc	UPC	Vendor	CS/UOS	Location
80090215	XS	639751239652	KWG515ACXS	12/12	National

Wonder GRIP® Nicely Nimble™

Breathable, textured nitrile palm coating on a comfortable seamless 15-gauge nylon knit. Three assorted colors.



Item #	Desc	UPC	Vendor	CS/UOS	Location
80090269	Small	639751401813	WG515ACS	12/12	National
80090270	Medium	639751401820	WG515ACM	12/12	National
80090271	Large	639751401837	WG515ACL	12/12	National

Wonder GRIP® Nearly Naked®

Breathable, textured nitrile palm coating on an ultra-lightweight seamless 18-gauge nylon knit. Three assorted colors.



Item #	Desc	UPC	Vendor	CS/UOS	Location
80090237	XS	639751401554	WG1850ACXS	12/12	National
80090238	Small	639751401516	WG1850ACS	12/12	National
80090239	Medium	639751401523	WG1850ACM	12/12	National
80090240	Large	639751401530	WG1850ACL	12/12	National

Bellingham® Nitrile TOUCH®

Abrasion & puncture resistant nitrile coating molds to the hand. Fits like a second skin! Excellent dexterity; breathable seamless nylon knit liner, six assorted colors. LFS's top selling garden glove.



Item #	Desc	UPC	Vendor	CS/UOS	Location
80090007	Small	639751137217	NT3700ACS	12/12	National
80090006	Medium	639751137224	NT3700ACM	12/12	National
80090005	Large	639751137231	NT3700ACL	12/12	National



Bellingham® Blue™ (A)

Premium, ergonomically shaped work glove. Tough, flexible, textured rubber palm. Anti-Oxidation Formula Latex. Seamless knit liner. Great grip, wet or dry. Tapered fingertips improve fit and dexterity and stabilized yarn will not shrink even after repeated machine washing.

Item #	Desc	UPC	Vendor	CS/UOS	Location
80090003	Small	639751202113	C3000S	12/12	National
80090002	Medium	639751202120	C3000M	12/12	National
80090001	Large	639751202137	C3000L	12/12	National
80090004	X-Large	639751202144	C3000XL	12/12	National

Bellingham® Grey™ (B)

Premium comfort and protection. Thick looped acrylic liner insulates and cushions hands. Textured rubber palm. Construction 10 gauge acrylic/polyester knit liner textured latex palm coating.

Item #	Desc	UPC	Vendor	CS/UOS	Location
80090015	Small	639751202519	C4510S	12/12	National
80090014	Medium	639751202526	C4510M	12/12	National
80090013	Large	639751202533	C4510L	12/12	National

Bamboo Gardener™ Rubber Palm (C)

Seamless knit bamboo liner keeps hands cool and comfortable. Natural rubber palm coat protects hands and enhances grip. 13-gauge Rayon Made From Bamboo, Polyester, Polyurethane, and other materials.

Item #	Desc	UPC	Vendor	CS/UOS	Location
80090021	Small	639751530117	C5301S	12/12	National
80090020	Medium	639751530124	C5301M	12/12	National
80090019	Large	639751530131	C5301L	12/12	National

Thorn-resistant Gauntlet Gloves

Canvas gauntlet protects forearms. Reinforced cowhide palm resists punctures and abrasion. Comfortable, reliable protection.



Item #	Desc	UPC	Vendor	CS/UOS	Location
80090506	Small	639751236811	C7352S	3/3	National
80090507	Medium	639751236828	C7352M	3/3	National

Bamboo Gardener™ Nitrile Palm (D)

Seamless knit bamboo liner keeps hands cool and comfortable. Nitrile palm coat resists punctures and abrasion. 13-gauge Rayon Made From Bamboo, Nylon, and Lycra.

Item #	Desc	UPC	Vendor	CS/UOS	Location
80090018	Small	639751537116	C5371S	12/12	National
80092756	Ladies Small	674326374758	C5370ACS	12/12	National
80090017	Medium	639751537123	C5371M	12/12	National
80092755	Ladies Medium	674326374765	C5370ACM	12/12	National
80090016	Large	639751537130	C5371L	12/12	National
80092754	Ladies Large	674326374772	C5370ACL	12/12	National

Bellingham® Nitrile TOUGH® (E)

Abrasion and puncture resistant nitrile coating molds to the hand. Fits like a second skin, wears like iron! Excellent dexterity; breathable seamless nylon knit liner. 13-gauge Nylon Knit Liner.

Item #	Desc	UPC	Vendor	CS/UOS	Location
80090010	Small	639751137316	NT3700BKS	12/12	National
80090009	Medium	639751137323	NT3700BKM	12/12	National
80090008	Large	639751137330	NT3700BKL	12/12	National
80090011	X-Large	639751137347	NT3700BKXL	12/12	National

Wonder Grip® Extra Grip (F)

Features a double coated textured latex palm and a tough 13-gauge nylon knit. Extra grip reduces hand fatigue.

Item #	Desc	UPC	Vendor	CS/UOS	Location
80090029	Medium	639751400427	WG310M	12/12	National
80090028	Large	639751400434	WG310L	12/12	National

Snow Blower™ (G)

PVC coated glove stays flexible to -4°F. Soft fleece liner adds warmth and comfort; textured coating provides excellent grip. 100% Acrylic lining. Double dipped PVC.

Item #	Desc	UPC	Vendor	CS/UOS	Location
80090236	X-Large	639751201246	SB4601XL	12/12	East

Gard Ware Nicely Nimble™

Breathable, textured nitrile palm coating on a comfortable seamless 15-gauge nylon knit. Three assorted colors.



Item #	Desc	UPC	Vendor	CS/UOS	Location
80091588	Small	674326333717	C515ACS	12/12	National
80091589	Medium	674326333724	C515ACM	12/12	National
80091590	Large	674326333731	C515ACL	12/12	National

Gard Ware Nearly Naked®

Ultra light weight 18 gauge nylon/spandex knit shell and durable, breathable single coated nitrile palm for excellent grip in wet or dry conditions. Three assorted colors



Item #	Desc	UPC	Vendor	CS/UOS	Location
80091568	Small	674326333755	C1850ACS	12/12	National
80091569	Medium	674326333762	C1850ACM	12/12	National
80091570	Large	674326333779	C1850ACL	12/12	National

Women's Tuscany Performance™

Premium natural leather palm and fingertips. Leather is drum dyed, a natural finishing process with a softer feel. Breathable spandex back with embossed logo and shirred wrist. Three assorted colors



Item #	Desc	UPC	Vendor	CS/UOS	Location
80090777	Small	639751410419	C7784ACS	12/6	National
80090778	Medium	639751410426	C7784ACM	6/6	National

Women's Slip On Synthetic Leather Palm Gloves

Padded synthetic leather palm and reinforced fingertips add protection. Patterned hyprene back provides attractive comfort and flexibility.



Item #	Desc	UPC	Vendor	CS/UOS	Location
80090806	Small	639751213713	C7333ACS	12/12	National
80090807	Medium	639751213720	C7333ACM	12/12	National
80090808	Large	639751213737	C7333ACL	12/12	National

Exceptionally COOL™ Gloves for Women

Lightweight, 13-gauge nylon knit with breathable polyurethane palm coat; three assorted patterns.



Item #	Desc	UPC	Vendor	CS/UOS	Location
80090024	Small	639751236514	C2603APS	12/12	National
80090023	Medium	639751236521	C2603APM	12/12	National
80090022	Large	639751236538	C2603APL	12/12	National

Kid Tuff Too™

These colorful, washable gloves will be instant winners with kids and the adults who like to buy things for them! Nylon knit with textured rubber palm, three assorted characters for each size.



Item #	Desc	UPC	Vendor	CS/UOS	Location
80090214	XS	639751237054	KT440ACXS	12/12	National
80090811	Toddler	639751237108	KT440ACT	12/12	National
80090812	XXS	639751237184	KT440ACXXS	12/12	National



Ducky Glove for Kids

This glove is already making a splash. Bright yellow nylon knit with bright orange nitrile 3/4 dip coating. Kids can use it as a puppet, too. Durable, washable, and lots of fun!



Item #	Desc	UPC	Vendor	CS/UOS	Location
80090032	Kids	639751105254	C1052T	12/12	National

BOSMERE

Slimline Water Barrel w/ Stand

Hot seller! Holds 26 gallons. Stand adds 12" to height. 12.5" x 14" x 37.5" h without stand. Comes with a stand and tap. Made in the UK.



Item #	Desc	UPC	Vendor	CS/UOS	Location
82010315	26 Gal.	5021711046437	K750	1/1	East

Original Neeleez Kneeler

Provides the ultimate comfort to your knees while carrying out weeding, planting and other tasks where you need to kneel down. It is light weight and waterproof to keep your knees dry in wet conditions. It has a durable quick dry neoprene outer skin with a memory foam cushion inner.



Item #	Desc	UPC	Vendor	CS/UOS	Location
82010243	Purple Kneeler	5013554200821	G125LI	6/6	National

Tomato Grow Bags

Easy to use and reuse just fill with compost excess moisture will drain through drainage holes. The bag is deep enough for tomato stakes or a tomato cage. Ideal for peppers your favorite herbs like rosemary or summer flowers. Made from wipe clean woven coated polyethylene with strong webbing handles making it easy to move around the patio. No need for a garden, brightens any patio when planted with flowers. Available in green color. Measures 12-1/2" diameter by 15" height.



Item #	Desc	UPC	Vendor	CS/UOS	Location
82010672	12.5"x15"	721082117157	K715	12/12	National

Down Under Plant Turner

Plant saucer rotates to offer your plant the best exposure to sun for uniformed growth



Item #	Desc	UPC	Vendor	CS/UOS	Location
82010059	16"	641341416107	S41610	8/8	National

Folding Kneeler Seat

Fitted with comfort pads on both seat and kneeler. Spring release allows Kneeler Seat to fold flat when not in use. Steel frame construction with a green powder coated finish, will last for years.



Item #	Desc	UPC	Vendor	CS/UOS	Location
82010024	24"x10"x19.5"	5013554144705	N470	3/3	National



Wren Scroll Trellis

Perfect for popping into containers or in the garden to give blooms and foliage support. Heavy duty green plastic coated for long lasting durability.

Item #	Desc	UPC	Vendor	CS/UOS	Location
82010675	12" x 8"	721082125053	L505	12/12	National
82010676	18" x 8"	600679001188	L510	12/12	National
82010570	36" x 16"	600679001362	L530	6/6	National

Ladder Pot Trellis

Great for popping into containers or in the garden to give blooms and foliage support. Heavy duty green plastic coated for long lasting durability 11.5" tall x 4" wide.

Item #	Desc	UPC	Vendor	CS/UOS	Location
82010144	Ladder style 11.5" x 4"	721082125039	L503	24/24	National

Wraparound Peony Support

This wrap around brace is the answer to a messy flower bed affected by wind and rain. Plastic coated to prevent rusting. The hoop of the wrap-around can be unhooked and wrapped around the grown plant or bush. Three legs provide strength and stability.

Item #	Desc	UPC	Vendor	CS/UOS	Location
82010705	15"x25"	721082056708	E670	24/24	National

Grid Support

This multiple bloom flower support suitable for many types of bushy flowers. Made of strong wire coated with dark green UV stabilized plastic. The grid construction of the frame gives individual bloom support.

Item #	Desc	UPC	Vendor	CS/UOS	Location
82010642	18"x25"	721082056302	E630	12/12	National



Down Under Plant Caddie

Our Plant Caddie is made of heavy duty, UV resistant plastic. Supports up to 500 lbs if planter is positioned evenly over wheels. Hole in the middle of the Plant Caddie helps your pots and planters drain properly to maintain healthy plants. Has 6 high quality wheels and 2 locking casters to help keep your caddie in place.



Item #	Desc	UPC	Vendor	CS/UOS	Location
82010246	14" - Black	641341144109	S14410	6/6	National
82010247	16" - Black	641341184105	S18410	6/6	National
82010248	20" - Black	641341204100	S20410	6/6	National
82010094	14" - Terra	641341144307	S14430	6/6	National
82010095	16" - Terra	641341184303	S18430	6/6	National
82010096	20" - Terra	641341204308	S20430	6/6	National

Down Under Plant Stand

The Bosmere Down Under Plant Stand prevents staining and rotting on all surfaces including decks, wood floors, carpet, tile or any other surface.



Item #	Desc	UPC	Vendor	CS/UOS	Location
82010685	12" Clear	641341104440	S10440	12/12	National
82010682	12" -Black	641341104103	S10410	12/12	National



Bamboo Torches

Classic Bamboo Torch with refillable fuel canister, fiberglass wick and fire retardant finish. Includes corrugated display box. Metal fuel canister can be filled with Citronella oil to help repel flying insects and mosquitoes.



Item #	Desc	UPC	Vendor	CS/UOS	Location
80340884	5' Napali	034613026171	Y2617A	48/48	East



bloem



Pink Flamingos

Colorful, fade resistant with galvanized steel legs that will not rust. Two classic poses - head up (25"x20") and head down (22"x20"). Features fun googly, moving eyes.

Item #	Desc	UPC	Vendor	CS/UOS	Location
80920770	2 pc.	811214020599	G2	6/6	National



Mini Mingo

2 Pack - 2.8" W x 5.8" H

One of the most popular lawn and garden accessories from the 1950s is available from Bloem! Now your home can feature this icon of retro hipster cool. These Pink Flamingos are made from the highest quality plastic for all-weather durability. Whimsical googly eyes and sturdy metal legs. Creative packaging for retail display.

Item #	Desc	UPC	Vendor	CS/UOS	Location
80920774	2 pack.	811214020636	G52	12/12	National

- GRIFFIN GAZETTE -

Published especially for top customers, the Griffin Gazette is loaded with news you can really use. Our team serves up timely production advice, retail inspiration, and product and variety information to help you bring your best crop to market. Check out the digital Gazette for exclusive bonus content not available in print!

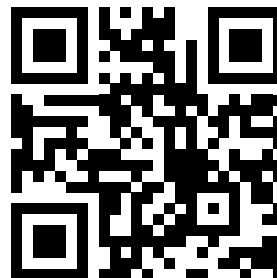

Visit <https://www.griffins.com/custom-site/publications> to browse the Gazette archives!



Fountains

Fountain comes equipped with pump.

Item #	Desc	Vendor	CS/UOS	Location
81791865	A Dorset Spshr Verdigris 25.6" x 15.8" x 23.6"	11006-VG	1/1	East
81791498	B Surrey Spshr Burnt Umber 15.75"x15.75x31.75	11031-BU	1/1	East
81791686	C Small Saverne Verdigris 16" L x 8" W x 30" H	11070-VG	1/1	East
81792393	D Charleston Birdbath 15.94" x 15.94" x 26.77"	11211-054	1/1	East
81792445	E Beverly Birdbath White 23.6" x 23.6" x 46.3"	11217-054	1/1	East
81792395	F Cascade 20.1" x 16.3" x 28"	11213-518	1/1	East
81792397	G Versailles 14.2" x 14.8" x 24.9"	11218-054	1/1	East
81792399	H Savannah 14" x 13.2" x 25.8" Blue	11214-136	1/1	East
81792446	I Savannah 14" x 13.2" x 25.8" White	11214-054	1/1	East

Rain Chain



Item #	Desc	UPC	Vendor	CS/UOS	Location
81792148	Umbrella 4x4x60	766282809839	44002	8/8	East
81792146	Flower 4x4x60	766282809815	44000	18/18	East

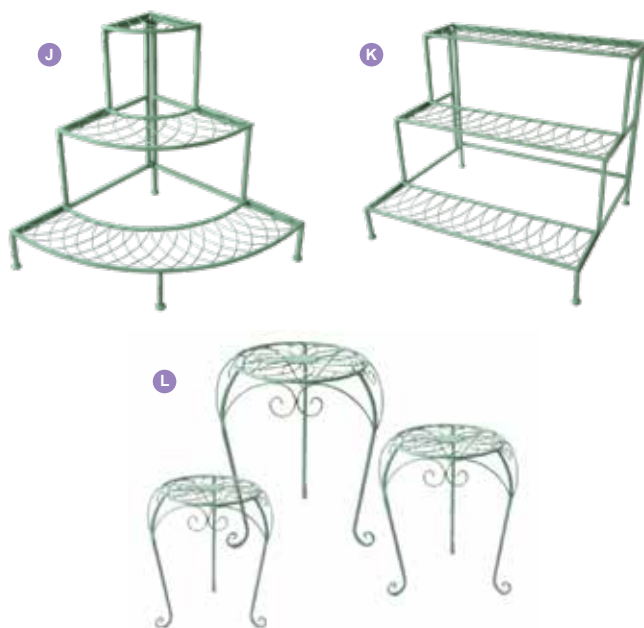

Antique Green Corner Plant Shelf (J)

Item #	Desc	Vendor	CS/UOS	Location
81791853	22.8x22.8x25	42002	2/2	East

Antique Green Plant Shelf (K)

Item #	Desc	Vendor	CS/UOS	Location
81791852	30x23.6x24.8	42001	2/2	East

Antique Green Plant Stands (L)

Item #	Desc	Vendor	CS/UOS	Location
81792181	Set of 3 13.8" L x 13.8" W x 16" H 10.6" L x 10.6" W x 10.6" H	42000	4/4	East



Inflatable Owl Display

Deters birds from decks, rafters, barns, docks, boats, marinas, etc.



Item #	Desc	UPC	Vendor	CS/UOS	Location
82170040	2 FT Tall	016069000028	NE-OR	12/12	National

Holographic Scare Tape

Reflective scare tape keeps your gardens safe from those crooked birds as its shifting holograms will shimmer beautifully in sunlight, disorienting and scaring them off.



Item #	Desc	UPC	Vendor	CS/UOS	Location
82170159	3/4" x 100' Roll	016069006792	HST-100CN	12/12	National

Harvest Guard

The Harvest Guard Premium Blanket offers reliable protection against frost, wind, and pests, ensuring the optimal growth and health of your plants. Its generous size provides ample coverage, allowing you to shield a large area of your garden or agricultural field.



Item #	Desc	UPC	Vendor	CS/UOS	Location
82170072	10' x 15'	016069000387	GF-1015	12/12	National
82170074	5' x 25'	016069000325	HG-25	12/12	National
82170078	8' x 6' Frost Protection Bag	016069005191	SPB5-6	12/12	National

Great Horned Hand Painted Owl

This Natural Enemy Scarecrow® deters pests from your yard and gardens. With its realistic design, Gardener's Great Horned Owl is the perfect deterrent device. This chemical-free device safely deters birds and unwanted pests and protects your dock, deck or boat. The hand-painted life-like design makes it look realistic and attractive to use in any place that needs some pest control.



Item #	Desc	UPC	Vendor	CS/UOS	Location
82170038	16"	016069000301	OW-6	6/6	National

Carefree Christmas Tree Watering Aid

Keep your tree looking fresh! Reduces Christmas Tree needle loss, all natural non-toxic. One bottle for trees under 8'. Mix entire bottle with 1 gallon of water and pour the solution into tree stand reservoir. Two bottles for trees over 8'. Mix both bottles with 1 gallon of water and pour the solution into tree stand reservoir.



Item #	Desc	UPC	Vendor	CS/UOS	Location
82170059	4 fl oz	016069006242	CCT-24	24/24	National



Arch Top Topiaries

Arch Top Topiary Set consists of 2 small and 2 large items plus stakes. All Deer Park Ironworks® products feature durable, heavy gauge metal construction and are protected with a baked-on, powder-coated finish. The natural patina appearance nicely complements any decor or color scheme. Small 12" x 36" Large 15" x 50"



Item #	Desc	UPC	Vendor	CS/UOS	Location
81920363	Set of 2	702085411398	TO215	2/2	East

Arch Top Topiaries

Small: 11"x11"x30"
Medium: 12.5"x12.5"x42"
Large: 14"x14"x60"

2 sets of three per case

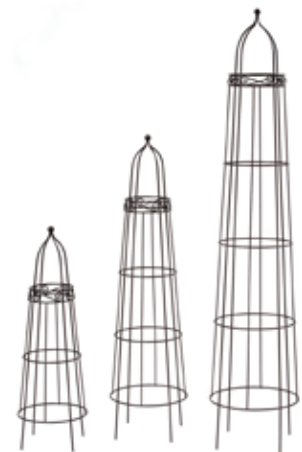

Item #	Desc	UPC	Vendor	CS/UOS	Location
81920355	S, M, L	702085410698	RN203SETB	2/2	East



RIVER NORTH COLLECTION

Made from heavy gauge wire | Holds pots up to 12"



Item #	Desc	UPC	Vendor	CS/UOS	Location
81920190	13"	635483011030	RN103B	6/6	National
81920191	21"	635483011047	RN104B	6/6	National
81920192	27"	635483011054	RN105B	6/6	National
81920195	2 Tier	635483011085	RN108B	1/1	East
81920193	63"x 18"	635483011061	RN106B	1/1	East

XXX Corner Rack

Beautiful and elegant, the Deer Park Ironworks XXX Corner Rack Plant Stand allows you to display your favorite flowers and plants in sophisticated style. Four shelves show off your plants while the delicate details perfectly complements the natural beauty of your backyard. Its classic elegance also makes this a beautiful addition inside your home. Made from durable, heavy gauge metal with a baked-on, powder-coated finish which helps to protect it from the elements. Natural Patina. 67" H X 23"W X 16"D



Item #	Desc	UPC	Vendor	CS/UOS	Location
81920128	35 lb Corner plant stand	702085400354	CR109	1/1	East

Tea Cart

Deer Park Tea Cart 30inx30inx17in with a natural patina appearance. Heavy gauge metal construction; baked-on, powder-coated finish. 30"L x 17"W x 30"H



Item #	Desc	UPC	Vendor	CS/UOS	Location
81920211	Natural Patina	702085400309	TC101	1/1	East
81920212	Black	702085405281	TC101-BLK	1/1	East

Large Flower Cart

64" x 40" x 27" black powder-coated finish.



Item #	Desc	UPC	Vendor	CS/UOS	Location
81920214	Black	702085405298	TC104-BLK	1/1	East

Premium Shepherds Plant Support - Black

Hang your favorite potted blooms from the extremely sturdy Deer Park Ironworks Premium Shepherds Hook Plant Support. Constructed of 5/8" solid steel and featuring a classic black powder-coated finish, your search is over to replace those flimsy shepherd hooks on the market today. All shepherd hooks come with 12" double Ground stake will anchor securely. Comes in your choice of available sizes.



Item #	Desc	UPC	Vendor	CS/UOS	Location
81920359	36" x 5/8"	702085410735	RN204SB	4/4	East
81920358	60" x 5/8"	702085410742	RN204MB	4/4	East
81920357	72" x 5/8"	702085410759	RN204LB	4/4	East
81920356	72" x 5/8" Dbl	702085410766	RN204DBLB	2/2	East

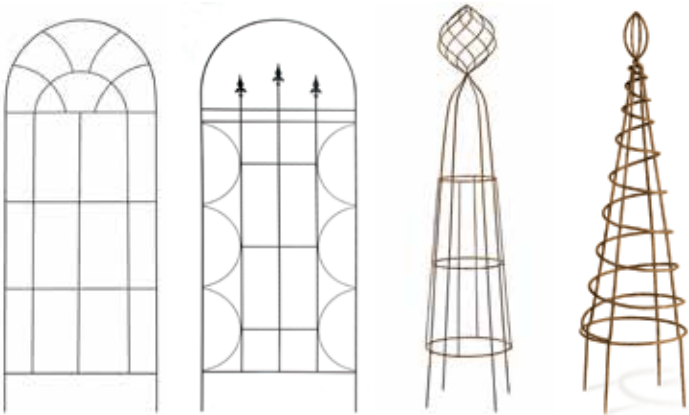

Arch Trellis - Black

Made of solid steel and powder-coated, Deer Park's Arch Trellis is especially designed for climbing plants.

Item #	Desc	UPC	Vendor	CS/UOS	Location
81920351	48" X 18"	702085410636	RN201SB	4/4	East
81920350	60" X 24"	702085410643	RN201MB	4/4	East
81920349	72" X 30"	702085410650	RN201LB	4/4	East

Steel Finial Trellis - Black

Give your favorite flowers and plants the support they need to grow with the Deer Park Ironworks Steel Finial Trellis. Constructed of durable steel and featuring a classic black powder-coated finish adorned with 3 fleur-de-lis, this trellis will be the focal point in your backyard or garden. Choose from available sizes.

Item #	Desc	UPC	Vendor	CS/UOS	Location
81920354	48" X 18"	702085410667	RN202SB	4/4	East
81920353	60" X 24"	702085410674	RN202MB	4/4	East
81920352	72" X 30"	702085410681	RN202LB	4/4	East

Firecracker Ball Topiary

Deer Park's Large Fire Cracker w/Ball Topiary is made of solid steel with a durable powder-coated finish that gives it a natural patina appearance. This topiary can function as a decorative piece or functional for climbing plants. Dimensions are 15" Diam. X 60"H plus stakes.

Item #	Desc	UPC	Vendor	CS/UOS	Location
81920221	Tall 15" Diam. x 60"H + stakes	702085403102	TO102	4/4	East
81920219	Short 11" Diam. x 45"H + stakes	702085400767	TO101	4/4	East

Spiral Topiary

The Spiral Topiary Planter is made with baked on powder coated finish for lasting durability. The unique finial top design adds a visual accent to flower or herb gardens. Climbing plants love to creep up the spiral frame.

Item #	Desc	UPC	Vendor	CS/UOS	Location
81920223	14" Diam. x 43"H + stakes	702085403379	TO103	4/4	National
81920225	16" Diam. x 55"H + stakes	702085403386	TO104	4/4	National

Lattice Plant Stand - Black

Deer Park's Lattice Plant Stand is made of durable steel and is powder-coated for long lasting outdoor or indoor use.



Item #	Desc	UPC	Vendor	CS/UOS	Location
81920362	16" x 15"	702085410810	RN206SB	6/6	East
81920361	21" x 15"	702085410827	RN206MB	6/6	East
81920360	27" x 15"	702085410834	RN206LB	6/6	East

2 Tier Rectangular Plant Stand

Black powder-coated steel, easy assembly. Measures 27"W x 13"(D) x 31"(H). Holds up to (2) 12" pots.

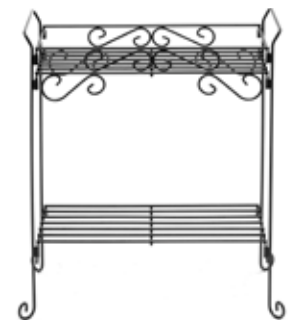

Item #	Desc	UPC	Vendor	CS/UOS	Location
81920189	2 tier	00635483011016	RN101B	1/1	East

Classic 3 Shelf Plant Stand

This plant stand sports a powder-coated finish that protects it from rust and other forms of corrosion. Three modular hanging pot holders outfit it. *Does not come with pots or plants pictured



Item #	Desc	UPC	Vendor	CS/UOS	Location
81920201	32"W x 16"D x 53"H	635483011238	RN123B	1/1	East



Dew Right

Tree watering bag designed to provide a drip irrigation system directly to roots over an extended period of time. Continuously waters for up to 8 hours.



Item #	Desc	UPC	Vendor	CS/UOS	Location
80010042	Tree Watering Bag	042579822782	TWBAG-12	12/12	National
80010093	Tree Watering Bag	042579822782	TWBAG-36	36/36	National

Patriotic Windy Wings

Add a touch of spirit into your patriotic garden. You will love the WindyWings Americana garden stake assortment! 4" x 4" x 16"



Item #	Desc	UPC	Vendor	CS/UOS	Location
80871218	24pc assortment	093335054527	5452	24/24	National

Windy Wings Flamingos Shelf Display

Fun Flamingos on stakes that have wings that move up and down to simulate flight when a breeze is blowing. Beautifully hand painted figures constructed of UV coated plastic for long life. Lacquer coated for a high gloss shine.



Item #	Desc	UPC	Vendor	CS/UOS	Location
80870049	24pc 6.5"x4"x15"	093335050383	5038	24/24	National

Windy Wings Songbirds Shelf Display

Add color and motion to your garden with beautifully hand-painted WindyWings Garden Stakes! As a breeze passes through, the Windywings glide up and down, simulating flight. 6.5" x 4" x 16"



Item #	Desc	UPC	Vendor	CS/UOS	Location
80870048	24pc assortment	093335050376	5037	24/24	National

Windy Wings Hummingbirds

This winged hummingbird on a tall stake is made from styrene plastic that is hand painted and UV treated. 8.9" X 7.3" X 28.7"

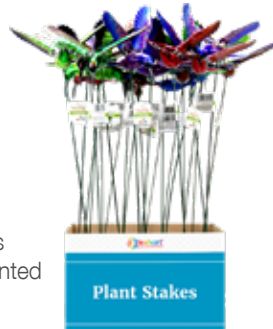

Item #	Desc	UPC	Vendor	CS/UOS	Location
80870473	24pc assortment	093335502066	50206	24/24	National

WindyWings Glass & Metal Butterflies Garden Stakes

Unique figures on stakes that have wings that move with the breeze. Beautiful, hand-painted butterflies. 5.9"L X 5.9"W X 26"H



Item #	Desc	UPC	Vendor	CS/UOS	Location
80871369	12 pc.	093335200276	20027	12/12	East
80871200	24 pc.	093335200184	20018	24/24	National

7" WindyWings Butterfly Garden Stakes

Unique figures on stakes that have wings that move with the breeze. Beautiful, hand-painted garden stakes with UV-coated plastic and a lacquer finish for high gloss. 7"L X 7" W X 29"H



Item #	Desc	UPC	Vendor	CS/UOS	Location
80870470	24 pc. assortment	093335502011	50201	24/24	National

4" WindyWings Butterfly

Unique figures on stakes that have wings that move up and down to simulate flight when a breeze is blowing. Beautifully hand painted figures constructed of UV coated plastic for long life. Lacquer coated for a high gloss shine. Assorted 4in Butterflies, 15in H with Stake, 12 Designs



Item #	Desc	UPC	Vendor	CS/UOS	Location
80870052	24pc assortment	093335051083	5108	24/24	National

Solar Double Spinner Wind Chime

Enjoy the relaxing sounds of these beautiful wind chimes as a gentle breeze passes through the hand-painted colorful butterfly design. The chimes will sing as double spinner twirls in two directions, adding music, color, and motion to your home. Makes a wonderful addition to your patio, yard, or garden and is an impressive gift for the garden enthusiast!



Item #	Desc	UPC	Vendor	CS/UOS	Location
80871615	16"x4.5"x42" Cardinal	093335721900	72190-RS	1/1	National
80871619	14"x4.5"x42" Butterfly	093335721870	72187-RS	1/1	National

WindyWings Whirligigs

Add fun, color and movement to your garden or anywhere with this beautiful, assorted garden stakes display. 3.5"L x 7"W x 28.75"H



Item #	Desc	UPC	Vendor	CS/UOS	Location
80870513	24pc assortment	093335506071	50607	24/24	National

Ruby Red Throat Hummingbird

The beautiful wings gently flutter in the breeze, and the built in solar panel will charge in the sun and automatically glow at night!



Item #	Desc	UPC	Vendor	CS/UOS	Location
80871332	6" x 4" x 18" 24 PC	093335058389	5838	24/24	National

4" WindyWings™ Mixed Assorted Shelf Display

Each stake is 13" tall. 24 piece mixed assortment in a plastic pot display. Includes (6 each): 4" butterflies, 4" dragonflies, 4" hummingbirds and 4" song birds. Comes fully assembled. Already positioned in a plastic pot. 95% plastic and 10% metal. 6" x 4.5" x 16"



Item #	Desc	UPC	Vendor	CS/UOS	Location
80870001	24pc assortment	093335050352	5035	24/24	National

Solar Glass Bird Garden Stakes

The beautiful wings gently flutter in the breeze, and the built in solar panel will charge in the sun and automatically glow at night!



Item #	Desc	UPC	Vendor	CS/UOS	Location
80871236	12pc assortment	093335547548	54754	12/12	National

WindyWings Dragonfly

Enjoy watching the translucent wings and bright body of a beautiful Dragonfly Garden Stake shine! With a simple breeze, the WindyWings will gently flutter simulating flight. Wherever this enchanting creature lands, it will stay, adding color and life to your garden. 6" x 4" x 15.5"



Item #	Desc	UPC	Vendor	CS/UOS	Location
80870056	24pc assortment	093335052424	5242	24/24	National

Glass Pineapple Garden Stake

A symbol of fun and hospitality, this illuminating Pineapple Garden Stake will light the way in your garden! The Solar powered LED light automatically glows from within at night. Textured hand blown glass and metal leafy crown give the pineapple a realistic touch and a designer flair. Makes a wonderful gift as well! 4.0" x 4.0" x 29.0"



Item #	Desc	UPC	Vendor	CS/UOS	Location
80871241	12pc assortment	093335207152	20715	12/12	East

7" WindyWings Assorted Wind Chimes

The vivid bright hues, the lovely sounds of the soothing chimes through the gentle breeze, and the "springed" wings that add whimsical motion, make this beautiful piece of garden art a delightful decorative accent to any home or yard! Hand painted with a special lacquer coating to protect the colors and provide a high-gloss shine. 4"x 8"x 21".



Item #	Desc	UPC	Vendor	CS/UOS	Location
80870436	24pc assortment	093335401048	40104	24/24	National

Metallic Daisy Stakes

Bring sprinkles and color to your garden these beautiful shimmering Metallic flowers.

9" x 3.2" x 35.8"



Item #	Desc	UPC	Vendor	CS/UOS	Location
80871396	12pc assortment	093335200214	20021	12/12	National



Eagle on a USA Flag Garden Statue

This stunning Bald Eagle Garden Statue with an American Flag detail will add a patriotic touch to your home or garden. Beautifully hand painted with great attention to detail and coated to withstand the elements outside, this elegant piece makes a proud addition to your home or garden. Enjoy indoors or out, UV treated to resist fading. Made of durable weather resistant resin 9.5" x 8.0" x 17.5"



Item #	Desc	UPC	Vendor	CS/UOS	Location
80871627	Eagle	093335172436	17243-RS	1/1	National

Solar Metal Dragonfly & Butterfly Spiral Garden Stakes

6pc Solar Metal Dragonfly and Butterfly with LED Spiral Tail Garden Stakes Assorted in Tray Display.



Item #	Desc	UPC	Vendor	CS/UOS	Location
80871472	8.5"x7.5"x31.5" 6 pc	093335550388	55038	6/6	National

Lily Garden Stake

A romantic blooming Red Lily Garden Stake illuminates at dusk gracing your garden with warmth and charm. This solar flower stakes is made of durable plastic to withstand the seasons and add an elegant touch of charm to your garden all year long. 4.0" x 5.0" x 35.0"



Item #	Desc	UPC	Vendor	CS/UOS	Location
80871469	9pc assortment	093335549733	54973	9/9	National

Solar Mini Hydrangea

Enjoy the full bloom and decorative glow of this gorgeous solar hydrangea garden stake day and night, all year long! At dusk, 26 solar-powered LED lights will automatically illuminate the beautiful, hand-painted flower. Adds an instant touch of color, light, and elegance to your garden. 7.0" x 7.0" x 21.5"



Item #	Desc	UPC	Vendor	CS/UOS	Location
80871209	4pc Solar Hyd Asst	093335541935	54193	4/4	National

Solar Garden Frog

An adorable frog and his jar full of sparkling LED fireflies adds a touch of childlike innocence and wonder to your garden. 6.0" x 7.5" x 11.0"



Item #	Desc	UPC	Vendor	CS/UOS	Location
80871025	Solar Frog	093335120727	12072-RS	1/1	National

Solar French Bulldog

A whimsical French bulldog and his jar full of LED fireflies make this solar-powered statue a charming addition to any garden. 6" x 7" x 10.5"



Item #	Desc	UPC	Vendor	CS/UOS	Location
80871609	Solar French Bulldog	093335717422	71742-RS	1/1	National

Solar Cardinals On Love Rock

Beautifully hand painted solar garden rock adds charm and warmth to your garden. Cardinals light up at night by a solar powered LED light! Made of durable weather resistant resin UV treated 6.5" x 4.5" x 8".



Item #	Desc	UPC	Vendor	CS/UOS	Location
80871347	Solar Cardinals	093335181995	18199-RS	1/1	National

Solar Bears Statue

Two adorable bears frame an illuminating bee hive in this heart warming garden statuary! At dusk, solar powered LED light will begin to glow from within the charming garden, highlighting both the hive and the little hand painted bees. The word "Welcome" is inscribed onto the hive for an added touch making this a beautiful piece of garden art. We are propelled by the joy of our customers as they create homes and gardens as wonderful as they are!



Item #	Desc	UPC	Vendor	CS/UOS	Location
80871665	Solar Bear	093335714216	71421-RS	1/1	National

Solar Gnome W/ Flower Hat

Solar powered LEDs provide an enchanting glow at dusk. Add instant charm and whimsy to your garden. made of durable resin for all season UV treated to resist fading 7.0" x 6.0" x 11.5"



Item #	Desc	UPC	Vendor	CS/UOS	Location
80871353	Gnome Statue	093335185917	18591-RS	6/6	National

Gnome Stoner Statue

Statues are constructed from a high quality resin that is resistant to breakage and able to endure most weather conditions. 7.0" x 10.5" x 10.5"



Item #	Desc	UPC	Vendor	CS/UOS	Location
80871300	Couch	093335157396	15739-RS	1/1	National

Solar Ganja Throne Gnome

Pay homage to your Good Time Ganja Throne Garden Gnome! Place this adorable gnome sitting on his throne of ganja anywhere and watch as his leaves illuminate each night at your desired time.



Item #	Desc	UPC	Vendor	CS/UOS	Location
80871389	12"	093335712694	71269-RS	1/1	East

Smoking Gnome Statues

This adorable gnome's bud garden will illuminate each night at your desired time. Simply set the battery timer and enjoy this handcrafted fun loving progressive home decor indoors or out! 5.0" x 5.5" x 12.5"



Item #	Desc	UPC	Vendor	CS/UOS	Location
80871259	Smoking Gnome Statue	093335157402	15740-RS	1/1	National

Fishing Gnome Statues

A playful reminder to slow down and enjoy life, this adorable fishing gnome is sure to put a smile on your face.



Item #	Desc	UPC	Vendor	CS/UOS	Location
80871002	12"	093335118168	11816-RS	1/1	National

Yoga Gnome Pot Stake

Colorful gnome adds a touch of charm and whimsy to any potted plant. Hand painted with adorable details. Ultra violet treated. Made of durable resin. Available in 3 colors. Cannot specify color. 8.5" x 7.5" x 31.5"



Item #	Desc	UPC	Vendor	CS/UOS	Location
80871462	12pc assortment	093335500543	50054	12/12	National



Treekote Aerosol Spray

This Treekote aerosol spray is tree wound dressing. Just apply to fresh pruned areas. It protects your shrubs, bushes, vines, and trees from decay, insects, and fungi.



Item #	Desc	UPC	Vendor	CS/UOS	Location
80470165	12 oz.	050699002120	300212	12/12	National

Grafting Wax

The oldest and most-used grafting wax in the country. Wax compounds comprised of natural rosins, tallow and vegetable wax. Perfectly seals all your grafting cuts and scions.



Item #	Desc	UPC	Vendor	CS/UOS	Location
80470167	1/4 lb. pkg	050699000140	300014	12/12	National

Vinyl Tree Wrap

Easy to apply white vinyl tree wrap. Simply begin at base of tree and wrap upward. Helps to protect trees from sunscald, severe frost, rodents, windburn and lawn trimmers. Also protects young trees from wind and storm damage and assures straight tree growth. Preserves moisture content of bark and prevents excessive dripping.



Item #	Desc	UPC	Vendor	CS/UOS	Location
80470182	24" 4 pc	050699004247	300424	12/12	National

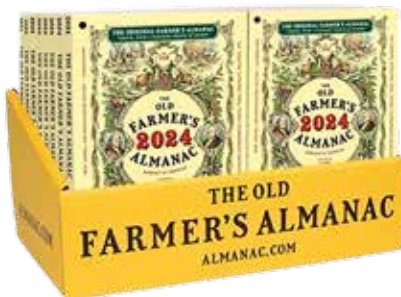
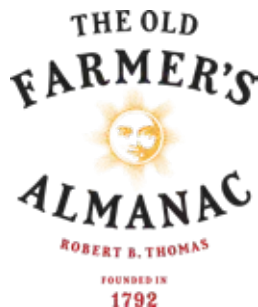

Old Farmer's Almanac

Counter Display. Recognized for generations by its familiar yellow cover, America's best-loved annual and oldest continuously published periodical (now in its 231st year!) promises to be "useful, with a pleasant degree of humor," once again fulfilling both the mission set forth by its founder, Robert B. Thomas, and readers' expectations. This edition is packed with wit, wisdom, tips, advice, facts, fun, recipes, and much more.

2024

Item #	Desc	UPC	Vendor	CS/UOS	Location
80460001	2024	014021032339	1024	24/24	East



Old Farmer's Almanac Gardening Calendar

A perennial favorite of gardeners for 45 years, this beautiful calendar offers original full-color illustrations, timely gardening advice, fun facts, quotes, and lore. The 2023 Gardening Calendar offers friendly reminders on when to start perusing seed catalogs or planting summer-flowering bulbs, inspiring quotations from poets and public figures, growing advice on favorite plants like forsythia and rhubarb, tips on getting rid of pests, and folklore for predicting how the weather will affect your garden. All packed into a stunning wall calendar!

Item #	Desc	UPC	Vendor	CS/UOS	Location
80460015	Calendar	14021032360	2020	20/20	East



Replacement Pole Aluminum

Easy to use 5-foot replacement aluminum pole for use with flags or banners. 1in diameter.

Item #	Desc	UPC	Vendor	CS/UOS	Location
80400377	5' Pole only	085199002141	25110	1/1	National



Replacement Flag 3' x 5' Poly/Cotton

Item #	Desc	UPC	Vendor	CS/UOS	Location
80400356	3'x5'	085199254045	25404	6/6	National



USA Polycotton Flag Dowel

Item #	Desc	UPC	Vendor	CS/UOS	Location
80400364	4"x6" ball tip	085199654319	25431F	144/144	National
80400365	8"x12" spear tip	085199654326	25432F	144/144	National
80400366	12"x18" spear tip	085199654333	25433F	144/144	National

Flags Stick Display

The Heath Outdoor Products - made in USA flags - #25154 combination pack. Includes 120 each 12-inch by 18-inch (#25433) staff flags and 108 each 4-inch by 6-inch 4-pack (#25434). Show your patriotism with pride. Cotton staff flags are perfect for parades, promotions or decorations. They feature a non-fray finish and are mounted on wooden staffs with flattened safety tips.



Item #	Desc	UPC	Vendor	CS/UOS	Location
80400381	Flag Display	10085199451564	25154-SW 1/1		National



Single Promo Shepherd Rod

Crane is 60" in height and a 1/2 solid round steel poll with one hook. Comes in black powder coat finish

Item #	Desc	UPC	Vendor	CS/UOS	Location
80630068	60"	727332608086	27532	6/6	National

Double Wrought Iron Shepherd Rod

81" Double Wrought Iron Shepherd rod with knock down base

Item #	Desc	UPC	Vendor	CS/UOS	Location
80630057	81"	727332204080	27506	6/6	National

Double Promo Shepherd Rod

Crane is 90" in height and with a 1/2" solid round steel with 2 hooks. Comes in a black powder coat finish.

Item #	Desc	UPC	Vendor	CS/UOS	Location
80630071	84"	727332620101	27535	6/6	National

J Hook With Flared End

Made of durable black powder coated steel; perfect for hanging your favorite plant, bird feeder, or decoration. Versatile hanger works in almost any indoor or outdoor setting. When hung securely this hook will hold up to 25 lb.



Item #	Desc	UPC	Vendor	CS/UOS	Location
80630037	3"	727332152039	27445	12/12	National

Upturn Straight Hanger

Comes in black powder coat finish. Hand made wrought iron.



Item #	Desc	UPC	Vendor	CS/UOS	Location
80630010	6"	727332124067	27409	12/12	National
80630009	15"	727332128157	27408	12/12	National

Fence And Deck Hook

Great for hanging a bird feeder near a window made of durable black powder coated steel also perfect for hanging your favorite plant, bird feeder, or yard ornament. Hand-crafted forged curl brings Old Word style to your backyard. When hung securely this hook will hold up to 15 lb.



Item #	Desc	UPC	Vendor	CS/UOS	Location
80630049	36"	727332060365	27480	6/6	National

Wrought Iron Shepherd Hooks

Single. Solid Square Steel. Item comes in black powder coat finish. Hand made heavy duty wrought iron.

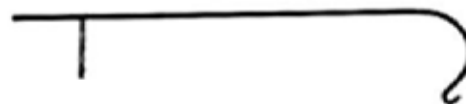

Item #	Desc	UPC	Vendor	CS/UOS	Location
80630051	48"	727332624086	27500	12/12	National
80630052	70"	727332000613	27501	6/6	National

Shepherd Hooks

Hook crane used to hold feeders and plants. Hand-crafted wrought iron construction.



Item #	Desc	UPC	Vendor	CS/UOS	Location
80630056	81" Single	727332200082	27505	6/6	National
80630053	90" Single	727332000620	27502	6/6	National

Curved Deck Rail Hook

Comes with a clamp for 2x4 or 2x6 Rail. Item comes in black powder coat finish. Hand made heavy duty wrought iron.



Item #	Desc	UPC	Vendor	CS/UOS	Location
80630050	36"	727332208101	27481	6/6	National

Upturn Angled Hanger

Comes in black powder coat finish. Hand made wrought iron.



Item #	Desc	UPC	Vendor	CS/UOS	Location
80630008	6"	727332116062	27407	12/12	National
80630007	12"	727332120120	27406	12/12	National



Upturn Curved Hanger

Comes in black powder coat finish. Hand made wrought iron.



Item #	Desc	UPC	Vendor	CS/UOS	Location
80630006	6"	727332100061	27405	12/12	National
80630005	9"	727332104090	27404	12/12	National
80630004	12"	727332108128	27403	12/12	National
80630003	18"	727332112187	27402	12/12	National
80630002	24"	727332113115	27401	6/6	National

Downturn Curved Hanger W/ Forged Curl

Black powder coated steel attaches to wood fences or decks. Long 48" hook allows you to hang your plant from the deck at just the right angle. When attached securely to a railing this hanger will hold up to 10 lb.



Item #	Desc	UPC	Vendor	CS/UOS	Location
80630013	16"	727332176912	27412	12/12	National

Plant Pot Ring

Hang potted plants where you want them with a plant pot ring. Multiple sizes available for varying container sizes in a black powder coat finish



Item #	Desc	UPC	Vendor	CS/UOS	Location
80630033	4"	727332300041	27460	12/12	National
80630034	6"	727332308061	27461	12/12	National
80630035	8"	727332312082	27462	12/12	National
80630036	10"	727332316103	27463	12/12	National

S Hooks

Items made with black powder coat finish. Hand made heavy wrought iron.



Item #	Desc	UPC	Vendor	CS/UOS	Location
80630025	4" x 1"	727332183118	27437	12/12	National
80630024	6" x 1"	727332183125	27436	12/12	National
80630026	6" x 2"	727332168061	27438	12/12	National
80630023	8" x 1"	727332183132	27435	12/12	National
80630027	12" x 2"	727332172129	27439	12/12	National
80630028	18" x 2"	727332176189	27440	12/12	National
80630029	24" x 2"	727332180247	27441	12/12	National

Downturn Curved Hanger

Heat-treated steel with a black matte finish. Useful for hanging plants or feeders.



Item #	Desc	UPC	Vendor	CS/UOS	Location
80630014	8"	727332176912	27413	12/12	National

Adjustable Deck Hanger w/ Clamp for Rail

Great for hanging a bird feeder near a window. Made of durable black powder coated steel. Also perfect for hanging your favorite plant, birdfeeder, or yard ornament. Hand-crafted forged curl brings Old World style to your backyard. When hung securely this hook will hold up to 15 Lbs.



Item #	Desc	UPC	Vendor	CS/UOS	Location
80630048	36"	727332183538	27479	6/6	National

Downturn Straight Hanger

Comes in black powder coat finish. Hand made wrought iron.



Item #	Desc	UPC	Vendor	CS/UOS	Location
80630012	10"	727332136107	27411	12/12	National
80630011	12"	727332140128	27410	12/12	National



Mask w/Ear Loop Nonwoven Cloth

Item #	Desc	UPC	Vendor	CS/UOS	Location
81311763	3-ply 20pk	869292900135	MSK	1/1	East



Spiral Metal Rain Gauge

Rapitest Rain Gauges are made to accurately record rain fall while decoratively accenting the yard, patio or garden. All of our cylinders are polystyrene to resist the effects of weather and resist breaking if dropped. All of our cylinders are also properly scaled up to 5" (12.5cm) using both imperial and metric measurements.



Item #	Desc	UPC	Vendor	CS/UOS	Location
80140173	Rain Gauge Spiral	035307016461	1646	6/6	National

Rapitest® Rain Gauge in Deco Holder

An attractive rain gauge for your container or garden bed. It will accurately measure the amount of moisture your garden or any outdoor area is receiving. The Rapitest Rainfall Gauge is scaled in both millimeters and inches. Includes adjustable mounting stake. Adjustable in height. Easy to assemble. Height: 39.5" Material: Vinyl coated steel.



Item #	Desc	UPC	Vendor	CS/UOS	Location
80140064	Rain Gauge	003530716409	1640	6/6	National

Rain Gauge with Bracket

Rapitest Rain Gauges are made to accurately record rain fall while decoratively accenting the yard, patio or garden. Whether they come with a decorative bracket or adjustable stake, all components are included for easy assembly and placement. All of our cylinders are polystyrene to resist the effects of weather and resist breaking if dropped.



Item #	Desc	UPC	Vendor	CS/UOS	Location
80140062	5"	035307016386	1638	6/6	National



SAVE MONARCH BUTTERFLIES PLANT MILKWEED

Decorative Garden Stake

The beautiful fairy butterfly graceful vintage pattern garden stake can decor your garden or lawn, adding color and life to your garden.

Item #	Desc	UPC	Vendor	CS/UOS	Location
80162160	Monarch Stake	093432285701	28570	12/12	National

Whimsical Plant Stand Tricycle

Whimsical tricycle plant stand with powder-coated finish. The generous platform and top support ring can accommodate pots up to 10 Inches in diameter. 24.5L x 12W x 17H in.



Item #	Desc	UPC	Vendor	CS/UOS	Location
80160333	Tricycle	093432891858	89185	2/2	East

Antique Red Industrial Wagon Planter

Plant stand has sturdy base and unique, industrial metal look, moving wheels and sewn in coco liner.



Item #	Desc	UPC	Vendor	CS/UOS	Location
80161386	14"	093432866887	86688	2/2	East

16" Green Grower's Wall Planter

Wall planter mounts easily to fenceline, wall, or railing. Includes coco fiber liner.



Item #	Desc	UPC	Vendor	CS/UOS	Location
80160154	16"	093432885093	88509	12/12	National

Milkhouse Herbs Oval Planter



Item #	Desc	UPC	Vendor	CS/UOS	Location
80161684	16"	093432826225	82622	6/6	National

CEA TECHNICAL TIPS!

Subscribe to our CEA e-mail program and learn helpful tips and tricks to optimize your growing facility!



Visit www.griffins.com to subscribe!

PANACEA®

Vintage Seed Pocket Buckets w/ Wood Handles

Assorted 2.5 quart aged galvanized buckets with handle displaying a vintage seed packet design.



Item #	Desc	UPC	Vendor	CS/UOS	Location
80161431	2.5 quart	093432832929	83292	12/12	National

Deck Railing Flower Box Holder

Decorative flower box holder can mount easily over a deck rail or round fence. Powder coated steel for added durability.

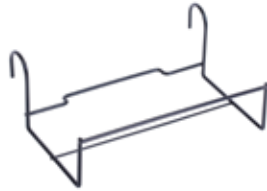

Item #	Desc	UPC	Vendor	CS/UOS	Location
80160244	Black 2" x 6"	093432890431	89043	6/6	National
80160242	Green 2" X 6"	093432890080	89008	6/6	National

Heart Shaped Folding Basket Hanger

An elegant heart shape design adds beauty to any outdoor area. Hanger will hold a 10" or 12" basket, which hangs from the unit to help keep the pot off the deck or patio.



Item #	Desc	UPC	Vendor	CS/UOS	Location
80160004	40"	093432881002	88100	6/6	National

Antique Gold Flower Bracket

Hanging plant bracket for indoor or outdoor use. Ideal for plants, bird feeders, wind chimes, and other hanging decor. Hanging hardware included for easy installation.



Item #	Desc	UPC	Vendor	CS/UOS	Location
80160233	9" Gold	093432856437	85643	6/6	National

Jumbo Ceiling Hook

Panacea's HoldAll® Jumbo ceiling hook features metal construction and a powder-coated finish.



Item #	Desc	UPC	Vendor	CS/UOS	Location
80160951	Black	093432861219	86121	6/6	National

Swivel Ceiling Hook

This small hook has a solid base, while the hook rotates 360°. This rotation allows you to see all facets of your hanging item, or allows your plants in hanging baskets to receive sunlight on all sides. The package includes a standard screw to mount the hook to a wooden ceiling or exposed beam, as well as a bolt and toggle nut for plaster or wallboard ceiling installations.



Item #	Desc	UPC	Vendor	CS/UOS	Location
80160205	Black 1 1/2"	093432861318	86131	6/6	National

Ceiling Hook

Ceiling Decorative hook that can hold wind chimes, flowering baskets, tube feeders or lanterns. Makes your garden look more complete. Powder-coated for added durability.



Item #	Desc	UPC	Vendor	CS/UOS	Location
80160954	Black 5pc	093432862018	86201	12/12	National
80160955	White 5pc	093432862025	86202	12/12	National
80160956	Antique 5pc	093432862056	86205	12/12	National

Wreath Hanger

Over-the-Door Wreath Hangers are designed as an easy way to hang your wreaths with ease. Each hanger fits over a door and then you hang your wreath on the hook.



Item #	Desc	UPC	Vendor	CS/UOS	Location
80161968	Black	093432362020	36202	12/12	National
80161969	White	093432362068	36206	12/12	National
80161970	Brass	093432362099	36209	12/12	National

Large Fleur-De-Lis Double Hook

Large fleur-de-lis double hook shepherd staff. Made of 1/2" rod material. Powder coated glossy black finish.



Item #	Desc	UPC	Vendor	CS/UOS	Location
80160172	72"	093432887226	88722	4/4	National

Single Shepherd Hook

Made from a solid square tube steel, stronger than the round wire shepherd's hooks and powder coated after they are formed.



Item #	Desc	UPC	Vendor	CS/UOS	Location
80160055	48" Single	093432894385	89438	10/10	National

Black Shepherd's Hook

Made of round steel wire approximately 1/2" thick and powder coated after it is formed into shape.



Item #	Desc	UPC	Vendor	CS/UOS	Location
80160029	36" Single	093432890240	89024	12/12	National
80160034	48" Single	093432890349	89034	10/10	National
80160021	64" Single	093432890035	89003	10/10	National
80160032	84" Single	093432890318	89031	10/10	National

Forged Hook With Leaves & Vines

The Panacea single Shepherd's Hook hang wind chimes, flower baskets, or flags virtually anywhere.



Item #	Desc	UPC	Vendor	CS/UOS	Location
80160295	84"	093432894446	89444	5/5	National

Hanging Plant Bracket

The hardened steel construction creates a sturdy piece, and the black finish helps draw the eye to it.



Item #	Desc	UPC	Vendor	CS/UOS	Location
80160235	12"	093432855218	85521D	6/6	National

10" Swivel Bracket



Item #	Desc	UPC	Vendor	CS/UOS	Location
80160203	Black	093432854013	85401	12/12	National
80160204	White	093432854020	85402	12/12	National

Forged Straight Hook

Made of solid round and square rod with a powder coated black finish for long life.



Item #	Desc	UPC	Vendor	CS/UOS	Location
80160053	15"	093432894156	89415	12/12	National

Extender S Hook



Item #	Desc	UPC	Vendor	CS/UOS	Location
80160212	Black 2-Pk	093432865019	86501	12/12	National
80160213	White 2Pk	093432865026	86502	12/12	National

Garden "S" Hook

Made of steel wire with a powder coated black finish.



Item #	Desc	UPC	Vendor	CS/UOS	Location
80160022	4" - 2 pk	093432890110	89011	12/12	National
80160023	6" - 2 pk	093432890127	89012	12/12	National
80160024	8" - 2 pk	093432890134	89013	12/12	National
80160026	18"	093432890158	89015	12/12	National
80160027	24"	093432890165	89016	12/12	National

PANACEA®

Wire Easel Stand

This 30-inch metal easel is made of powder-coated steel. The legs of this easel are designed to easily be driven into soft ground for items to be at the gravesite. It flaunts a green shade that will blend well with your outdoor decor.



Item #	Desc	UPC	Vendor	CS/UOS	Location
80160888	30"	093432310052	31005	60/60	National

"J" Hooks

Available in black color. Made of solid round and square rod with a powder coated black finish for long life.



Item #	Desc	UPC	Vendor	CS/UOS	Location
80160044	3" w/Screw	093432894033	89403	24/24	National
80160045	6" Threaded	093432894040	89404	24/24	National

36" Extender Chain

3 pack

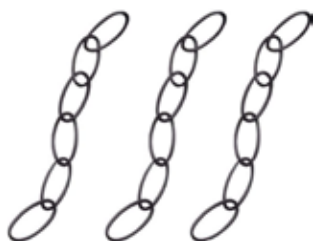

Item #	Desc	UPC	Vendor	CS/UOS	Location
80160208	White	093432864029	86402	6/6	National
80160207	Black	093432864012	86401	6/6	National

Swag Hook



Item #	Desc	UPC	Vendor	CS/UOS	Location
80160885	Black 2 Pack	093432861011	86101	6/6	National
80160886	White 2 Pack	093432861028	86102	6/6	National

PATIO ESSENTIALS®



Citronella Candle Mason Jars

Add a little farmhouse charm to your outdoor space with these Mason Jar Citronella Candles! The warm, neutral colors (smokey brown, grey, and wine bottle green), the vintage-inspired embossed text are just a few of the details on these candles that give them extra charm and character. The matte black lid adds to the vintage vibe but also serves the practical purpose of protecting the candle when it's not in use.

Item #	Desc	UPC	Vendor	CS/UOS	Location
81330137	5oz	811381024017	22843	9/9	East
81330008	10oz	811381021948	22500	9/9	East



Tea Light Holder Colored Glass Bottles

Add a cozy glow to your outdoor space with these Hanging Glass Tealight Holders! Available in blue, pink, green, and clear, these tea light holders are inspired by the shape of vintage milk bottles and have small floral relief on them so that they have a fun, playful style that works in any space. The base of the lantern is made from metal for stability and easy access to light and replace the candle, and comes with an attached chain and hook if you want to hang your lantern! For use with standard-sized tealight candles, we recommend using our Patio Essentials Citronella Tealight Candles to help add to your barrier of protection.

Item #	Desc	UPC	Vendor	CS/UOS	Location
81330074	Colored	811381021481	22460	8/8	East

Torch Fuel

Fill your torches with our Citronella-Scented Torch Fuel to create a cozy ambiance in your outdoor space and add to your barrier of protection. Our EZ-Fill cap and curved handle of the back of the bottle help prevent spills and splashes when filling your torch canisters.



Item #	Desc	UPC	Vendor	CS/UOS	Location
81330098	44 oz Citronella	815094012903	PETF044	9/9	East
81330100	64 oz Citronella	815094012927	PETF064	6/6	East

Bamboo Torches

Enhance your backyard bash with our Woven Rope Bamboo Torches! The woven rope and dark bamboo these torches have a natural but distinct look that adds a fun feel to your outdoor activities. Fill your torches with our Citronella-Scented or Scatterbug torch fuel and space them 18-36 inches apart around the perimeter of your outdoor space for best results.



Item #	Desc	UPC	Vendor	CS/UOS	Location
81330056	Rope Bamboo Torch	815094013177	30055-150	24/24	East

Beachcomber Bamboo Torches

Made from natural woven bamboo, this full-length garden torch complements any yard and is durable enough to withstand outdoor use. The fiberglass wick will illuminate your yard with ample torchlight and provide a long-lasting burn.



Item #	Desc	UPC	Vendor	CS/UOS	Location
81330150	Woven Bamboo Torch	815094013160	30928-150	24/24	East

Mossy Oak Mosquito Repellent

Settle in on the porch after a long day of hunting with our 8-ounce Mossy Oak Metal Tin Citronella Candles to enjoy the evening. Wrapped in Mossy Oak's Break Up Country pattern, you'll feel like you're still out in the woods, but without the bugs! Whether you're up at the hunting lodge or sitting in your back yard wishing it was hunting season, grab a few of these citronella candles and space them 18-36 inches apart to enjoy the great outdoors Mossy Oak style.



Item #	Desc	UPC	Vendor	CS/UOS	Location
81330082	8 oz.	815094013269	21168	9/9	East



Citronella Glass Candle

Our Patio Essentials 10-ounce Retro Glass Citronella Candles add a fun and colorful atmosphere to any outdoor party! Whether you're celebrating a big birthday or just having a family dinner out on the patio, these medium-sized candles are perfect for scattering on tables and surfaces throughout the yard or to line a long dining table. These citronella candles come in a textured glass container in hot pink, blue, and green. Grab multiple candles in the same color or mix and match for variety and then space them 18-36 inches apart in your outdoor space to help create a barrier of protection.

Item #	Desc	UPC	Vendor	CS/UOS	Location
81330011	10 oz.	815094013283	22249	9/9	East

LED Color Changing Candle

Watch as an array of colors brighten your outdoor space when you light our Patio Essentials 7-ounce Color-Changing Citronella Candle, 3-Pack! The heat-activated LED technology in these small citronella candles creates a northern lights-like color-changing display. As the candle heats up, the frosted glass will start to light up and flicker through a range of colors like pink, yellow, orange, green, blue, and purple. These candles are at their most dazzling after the sun goes down, so make sure to keep the lid on them whenever they aren't in use—it helps to protect the candle from the elements, but also helps preserve the battery life of the LEDs that create the colorchanging effects.



Item #	Desc	UPC	Vendor	CS/UOS	Location
81330107	LED Candle	811381022570	22278-LED	12/12	East

Citronella Candle Lantern

Allow yourself to enjoy your backyard and outdoor activities to their fullest. Patio Essential's Citronella Candle Lantern keep bugs away so you can enjoy your summer nights in the yard. They look great as well. They are the perfect addition to any yard or party.



Item #	Desc	UPC	Vendor	CS/UOS	Location
81330103	Lantern	811381022266	22533	4/4	East



22" Decorated Pumpkin

Halloween decoration fun for inside or out. Can be used non-illuminated, or illuminated with cord.

Item #	Desc	UPC	Vendor	CS/UOS	Location
81320067	Cord/light included	78304558411	55841	1/1	East

Pink Flamingos

Includes 1 each 29" standing & 19" feeding, made from sturdy salmon pink weather resistant plastic and metal legs. Each flamingo includes Don Featherstones signature. Comes in a colorful tropical retail display box.



Item #	Desc	UPC	Vendor	CS/UOS	Location
81320002	Pink Flamingos	078304623607	62360	4/4	East

Union Featherstone Realmingo

52" original Featherstone feeding flamingo statue. Body is weather & fade-resistant plastic and the leg is painted weather resistant wood.



Item #	Desc	UPC	Vendor	CS/UOS	Location
81320003	Garden Flamingo	078304625656	62565	1/1	East

Zombie Flamingos

With this Zombie flamingo pair standing guard, maybe the real Zombies won't bother you - they'll think their cohorts have beat them to the punch. One of these frightening birds is standing while the other is feeding; both are on high alert. 12.2 x 4 x 18.5 inches.



Item #	Desc	UPC	Vendor	CS/UOS	Location
81320073	Zombie Flamingos	078304623638	62363	4/4	East



EcoMaster® Nitrile Palm PTE Garden Gloves

13 gauge Eco-friendly Recycled PTE/Spandex Seamless Liner is soft and moisture wicking for a comfortable wear. Breathable micro-finish nitrile palm coating provides improved durability and grip. Available in 3 assorted colors.



Item #	Desc	UPC	Vendor	CS/UOS	Location
80092743	Small	674326370354	C3705ACS	12/12	National
80092744	Medium	674326370361	C3705ACM	12/12	National
80092745	Large	674326370378	C3705ACL	12/12	National



Ladybug & Bumblebee Wall Décor

12" Ladybug and Bumblebee Wall Décor

Item #	Desc	UPC	Vendor	CS/UOS	Location
80731341	12"	727744402647	MLB12	8/8	East

Colorful Frog & Gecko Wall Décor

18" Colorful Frog and Gecko Wall Décor



Item #	Desc	UPC	Vendor	CS/UOS	Location
80731339	18"	727744402630	MCFG18	6/6	East



Sun with Blue & Green Rays

29" Sun with Blue and Green Rays.
Metal wall decor.



Item #	Desc	UPC	Vendor	CS/UOS	Location
80731342	29"	727744402685	MSBG29	4/4	East

Ladybugs

19" Red, Blue, and Yellow Ladybugs. wall decor.
Made of metal



Item #	Desc	UPC	Vendor	CS/UOS	Location
80731279	19"	727744402425	MRBYL19	12/12	East

Oval Planter w/ Gardening Tools

12"L x 5"W x 5"T, metal planter.



Item #	Desc	UPC	Vendor	CS/UOS	Location
80731123	12"	727744803123	FOPT15	12/12	East

Vibrant Dot Butterfly

20" metal butterfly wall decor



Item #	Desc	UPC	Vendor	CS/UOS	Location
80731343	20"	727744402692	MVDB20	4/4	East

Vibrant Dot Dragonfly

20" metal dragonfly wall decor



Item #	Desc	UPC	Vendor	CS/UOS	Location
80731344	20"	727744402708	MVDD20	4/4	East



6165 L'il Buggers

100% cotton. Snug-fitting knit wrist.



Item #	Desc	UPC	Vendor	CS/UOS	Location
82290059	XX-Small	065537071466	6165	12/12	East

6171 Oh, Snap! (Kids)

15gg WasteNot™ polyester knit made from 23.5% (+/- 2%) recycled post consumer PET bottles. Sandy latex palm coating. Ergonomically formed. Snug-fitting seamless knit wrist.



Item #	Desc	UPC	Vendor	CS/UOS	Location
82290042	XX-Small	065537866277	6171-XXS	6/6	East
82290041	X-Small	065537866284	6171-XS	6/6	East

6146 L'il Monkees (Kids)

Nylon seamless knit. Rubber crinkle latex coating. Snug-fitting knit wrist.



Item #	Desc	UPC	Vendor	CS/UOS	Location
82290057	X-Small	065537823454	6146	12/12	East

6163 Splish & Splash (Kids)

6163 Splish & Splash Gloves are the perfect size for your children! At a very small Kids Size XXS these nylon seamless knit gloves have a rubber crinkle latex coating to keep your kids hands safe while they play in the yard with mom and dad. These gloves have a snug fit wrist cuff to prevent dirt and grime from getting into the glove keeping your hands clean.



Item #	Desc	UPC	Vendor	CS/UOS	Location
82290058	X-Small	065537829197	6163	6/6	East



204 Sparrow (A)

Spandex back made with WasteNot™ yarn is comprised of 96% recycled PET bottles, microfibre palm and silicone printed palm. Features hooded fingertips and knuckle bar, snug fitting shirred elastic wrist with slip-on style cuff.

Item #	Desc	UPC	Vendor	CS/UOS	Location
82290010	Small	065537866109	204-S	6/6	East
82290009	Medium	065537866116	204-M	6/6	East
82290008	Large	065537866123	204-L	6/6	East

111 Uptown Girl (B)

Spandex back made with WasteNot™ yarn is comprised of 96% recycled PET bottles, hooded fingertips and padded knuckle bar, wavy polyurethane coated palm for a sure-grip conductive thumb and fingertips can be used on touchscreen devices. Snug fitting shirred elastic wrist with slip on style cuff.

Item #	Desc	UPC	Vendor	CS/UOS	Location
82290064	Small	065537824055	111-S	6/6	East
82290063	Medium	065537824062	111-M	6/6	East
82290062	Large	065537824079	111-L	6/6	East

376 Rosé (C)

A customer favorite! WasteNot™ polyester seamless knit gloves are made from 30% recycled post consumer PET bottles. These lightweight gloves have a sandy latex coating engineered with Reclaim™ additive that accelerates biodegradation in landfill conditions (ASTM DSSII), treated to bead water off which lasts up to 5 washes, snug-fitting seamless knit wrist.

Item #	Desc	UPC	Vendor	CS/UOS	Location
82290103	Small	065537905709	376-S	6/6	East
82290102	Medium	065537905723	376-M	6/6	East
82290101	Large	065537905716	376-L	6/6	East

375 Karma (D)

WasteNot™ polyester seamless knit gloves are made from 25% recycled post consumer PET bottles. These lightweight gloves are engineered with a foam nitrile palm engineered with Reclaim™ additive that accelerates biodegradation in landfill conditions. (ASTM DSSII)

Item #	Desc	UPC	Vendor	CS/UOS	Location
82290035	Small	065537866178	375-S	60/6	East
82290034	Medium	065537866185	375-M	60/6	East
82290033	Large	065537866161	375-L	60/6	East

317 Lite as a Feather (E)

WasteNot™ polyester seamless knit gloves made from 50% recycled post consumer PET bottles. These lightweight polyurethane gloves are engineered with a Reclaim™ additive that accelerates biodegradation in landfill conditions (ASTM DSSII), snug-fitting seamless knit wrist.

Item #	Desc	UPC	Vendor	CS/UOS	Location
82290077	Small	065537858845	317-S	6/6	East
82290076	Medium	065537858852	317-M	6/6	East
82290075	Large	065537858869	317-L	6/6	East

307 Women's Game of Thorns (F)

Hard-wearing microfibre palm, padded palm patch, Spandex back made with WasteNot™ yarn is comprised of 96% recycled PET bottles, reinforced hooded fingertips, knuckle bar and thumb saddle, microfibre laminated PVC gauntlet style cuff.

Item #	Desc	UPC	Vendor	CS/UOS	Location
82290074	Medium	065537832661	307-M	6/6	East
82290073	Large	065537832678	307-L	6/6	East

314 Men's Game of Thorns (G)

Billions of plastic bottles go into landfills every year. But now you can do something about it. Our WasteNot™ yarn is made from 100% recycled PET bottles. PET stands for polyethylene terephthalate which is a form of polyester. Plastic bottles made from PET are recycled and turned into polyester to make gloves.

Item #	Desc	UPC	Vendor	CS/UOS	Location
82290056	One Size	065537836430	314	6/6	East



MUD Bamboo Latex Dipped Gloves

Watermelon and magenta.
One size M/L



Item #	Desc	UPC	Vendor	CS/UOS	Location
81751208	M/L	662909514967	MD32001W-WML	3/3	East

Ladies Mud Glove Nitrile Palm w/ Daisy Print

These daisy print gloves are lightweight, and feature a flat nitrile-coated palm.



Item #	Desc	UPC	Vendor	CS/UOS	Location
81751141	XS/S	662909514295	MD31001B-WXS	3/3	East
81751142	S/M	662909514301	MD31001B-WSM	3/3	East
81751143	M/L	662909514318	MD31001B-WML	3/3	East

Kids Simply Mud

Latex free to avoid allergic reactions. Form fitting extended cuff keeps glove on and debris out. Breathable lightweight nylon liner to keep your hand cool. Water resistant textured nitrile palm provides excellent grip, wet or dry.



Item #	Desc	UPC	Vendor	CS/UOS	Location
81751129	Huckleberry	616314186011	081H/K	6/6	East
81751130	Kiwi	616314186028	081K/K	6/6	East

Bamboo Double Dipped Latex Work Gloves

the work gloves feature a double dipped latex coating, the flat latex undercoating is water resistant which acts as a barrier keeping your hands dry and protected from any water, mud, chemicals, grease, and oil while on the job.



Item #	Desc	UPC	Vendor	CS/UOS	Location
81751206	XS/S	662909514943	MD32001W-WXS	3/3	East
81751207	S/M	662909514950	MD32001W-WSM	3/3	East

Simply MUD Gloves

Simply Mud gloves have a microsurface nitrile coating. Lightweight and form fitting nylon shell. Huckleberry- blue Passion Fruit - purple



Item #	Desc	UPC	Vendor	CS/UOS	Location
81751082	Passion S	616314063886	021PF/S	6/6	East
81751126	Huckleberry S	616314147951	021H/S	6/6	East
81751083	Passion M	616314063893	021PF/M	6/6	East
81751125	Huckleberry M	616314147944	021H/M	6/6	East
81751084	Passion L	616314063909	021PF/L	6/6	East
81751124	Huckleberry L	616314147937	021H/L	6/6	East

MUD Original Glove

Keep your hands comfortable and dry. Latex crinkle grip for enhanced wet and dry grip. Thick coating on palm is extra thick for enhanced puncture and abrasion resistance.



Item #	Desc	UPC	Vendor	CS/UOS	Location
81751067	Violet-S	616314062803	020DP/S	6/6	East
81751063	Lime-S	616314062766	020AG/S	6/6	East
81751069	Violet-L	616314062827	020DP/L	6/6	East

MUD Women's Nylon w/ Flexible Nitrile Palm



Item #	Desc	UPC	Vendor	CS/UOS	Location
81751212	Amethyst-XS	662909515544	MD31031A-WXS	3/3	East
81751216	Pear-XS	662909515582	MD31031P-WXS	3/3	East
81751220	Sweet Pea-XS	662909515629	MD31031SP-WXS	3/3	East
81751213	Amethyst-S	662909515551	MD31031A-WS	3/3	East
81751217	Pear-S	662909515599	MD31031P-WS	3/3	East
81751221	Sweet Pea-S	662909515636	MD31031SP-WS	3/3	East
81751214	Amethyst-M	662909515568	MD31031A-WM	3/3	East
81751218	Pear-M	662909515605	MD31031P-WM	3/3	East
81751222	Sweet Pea-M	662909515643	MD31031SP-WM	3/3	East
81751219	Pear-L	662909515612	MD31031P-WL	3/3	East
81751223	Sweet Pea-L	662909515650	MD31031SP-WL	3/3	East



HI-VIZ Lime Green Mesh Safety vest

One Size



Item #	Desc	UPC	Vendor	CS/UOS	Location
81751252	Safety Vest	662909000000	SW46202-O	1/1	East



Boss® V2 FLEXI-GRIP® High-Vis

Textured, poly knit with latex-coated palm provides exceptional grip and protection from abrasions. A fluorescent polyester shell offers good visibility, breath-ability and movement.

Item #	Desc	UPC	Vendor	CS/UOS	Location
81750615	Small	072874064846	8412B	12/12	East
81750465	Medium	072874064648	8412M	12/12	East
81750466	Large	072874064655	8412L	12/12	East
81750467	X-Large	072874064662	8412X	12/12	East

Jersey Work Gloves Brown

Jersey work gloves are a comfortable and breathable fit. Ideal for light tasks, stretch back for flexibility, knit wrist to keep out dirt and debris. *6/pairs in per bag

Item #	Desc	UPC	Vendor	CS/UOS	Location
81750370	Large	072874004231	4020	1/1	East
81750373	3 pc Bag	072874402303	4023	1/1	East

Boss® Jobmaster® Nylon Nitrile Coated Glove

Maximum dexterity and tactility. Nylon with nitrile coated palm. Resistance to abrasions & cuts. Open, breathable back. Flexible knit wrist seals out dirt & debris.

Item #	Desc	UPC	Vendor	CS/UOS	Location
81750514	Medium	072874069483	8442M	12/12	East
81750515	Large	072874069490	8442L	12/12	East
81750516	X-Large	072874069506	8442X	12/12	East

Disposable Nitrile Power Free



Item #	Desc	UPC	Vendor	CS/UOS	Location
81750880	Large	072874083731	1UH0088BL	50/50	East

Gauntlet Rose Glove

Durable suede shell for protection against sharp objects. Padded palm for extra protection from sharp objects. Synthetic suede gauntlet cuff for forearm protection.



Item #	Desc	UPC	Vendor	CS/UOS	Location
81751368	Moss-S	838237002722	054M/S	6/6	East
81751353	Ruby-S	838237001664	054R/S	6/6	East
81751369	Moss-M	838237002739	054M/M	6/6	East
81751354	Ruby-M	838237001671	054R/M	6/6	East
81751370	Moss-L	838237002746	054M/L	6/6	East
81751371	Moss-XL	838237002753	054M/XL	6/6	East

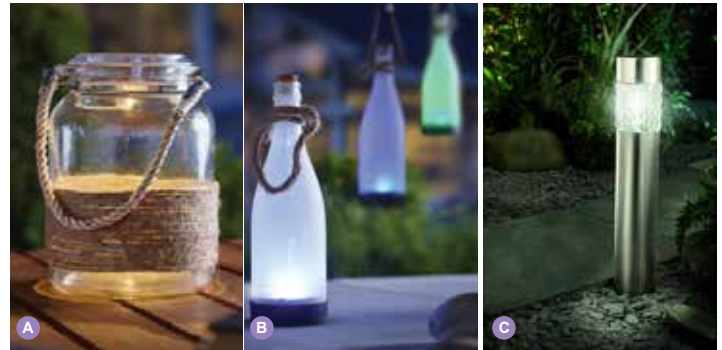

Hanging Solar Jar (A)

The Solar Hanging Jar is perfect for entertaining and outdoor dining. Suitable for hanging or freestanding. Made of glass with a rope handle. Fully-charged AAA battery included for its LED light.

Item #	Desc	UPC	Vendor	CS/UOS	Location
81730488	Large-Blue	814567026850	6730	9/9	East

Hanging Solar Bottle (B)

The Solar Hanging Bottle is perfect for entertaining and outdoor dining. Suitable for hanging or freestanding. Made of glass with a rope handle. Fully-charged AAA battery included for its LED light.

Item #	Desc	UPC	Vendor	CS/UOS	Location
81730473	Solar	814567025204	6740	12/12	East

Light Motion Sensor Stainless Steel Bollard (C)

Motion sensor bollard light perfect for illuminating pathways. Standby mode is 5 lumens. Increases to 50 lumens when motion sensor is activated.

Item #	Desc	UPC	Vendor	CS/UOS	Location
81730481	Sensor	814567025280	6762	12/12	East

LAWN & GARDEN PROBLEM SOLVERS



CHECK OUT OUR
CLEARANCE ITEMS!



Griffin Greenhouse Retail WAREHOUSE Shipping Map

We are now shipping nationwide!

NATIONAL



2024

Refer to location key:

National items are stocked nationally
 Select items are sold East or West only; no exceptions

8" Kaleidoscope Planter

Premium plastic modular planter can be displayed individually each planter has a removable saucer ideal for succulents or shallow rooted planted.

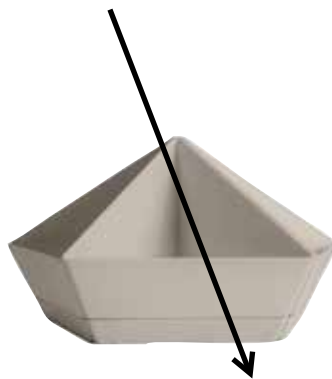

Item #	Desc	UPC	Vendor	CS/UOS	Location
80282643	Vanilla Bisque	770932844170	KDP08000A58	6/6	National

Where is the pricing?

1. Scan QR code on Chapter Pages to see pricing on Griffins.com
2. Contact your Griffin Sales Representative
3. Call into Griffin Customer Service 800.888.0054



ARBER



Bio Fungicide

Control challenging diseases longer with our natural bio fungicide. Protects against fungus, mold, mildew, and rot using Mother Nature's good bacteria. Say goodbye to disease on your leaves and in your soil and hello to stronger plants.

Item #	Desc	UPC	Vendor	CS/UOS	Location
82200006	8 oz Con.	850025915199	1-331762-2	6/6	East
82200002	16 oz Con.	850025915007	1-331712-1	6/6	East

Bio Insecticide

Prevent insect and mite build up and suppress soil-dwelling pests with our Bio Insecticide. This unique formulation uses good bacteria that's harmless to beneficial insects and pollinators and helps your plant thrive. Grow plants, not pests with over 20 natural compounds that are effective against the smallest yet mightiest of pests.

Item #	Desc	UPC	Vendor	CS/UOS	Location
82200008	8 oz Con.	850025915205	1-341762-2	6/6	East
82200003	16 oz Con.	850025915014	1-341712-1	6/6	East

Bio Protectant

Our Bio Protectant acts to increase your plants' chlorophyll production to keep them greener longer while also boosting your plants' immune system to ensure your plants remain healthy.

Item #	Desc	UPC	Vendor	CS/UOS	Location
82200007	8 oz Con.	850025915182	1-521762-2	6/6	East
82200001	16 oz Con.	850025915038	1-521712-1	6/6	East

Spray Bottle

Ensure your gardens get their required hydration and nutrients with our Spray Bottle. Featuring a spray nozzle and a translucent design, the Spray Bottle holds up to 32oz making mixing up our concentrates simple and adding convenience to your regular plant wellness routine.



Item #	Desc	UPC	Vendor	CS/UOS	Location
82200005	32oz.	850025915045	3-764926-1	6/6	East

Atlas Chemical Corp.

Super Gasser

Atlas Giant Destroyers is designed to permanently get rid of pesky burrowing animals, such as gophers, groundhogs, moles, and ground squirrels from your yard. Insert a giant destroyer cartridge into the tunnel and cover all the exits. Then light the Giant Destroyer to release gas into the tunnels. The gas will instantly kill underground pests.



Item #	Desc	UPC	Vendor	CS/UOS	Location
82520001	Super Gasser	010052003331	00333	48/48	West

BONIDE® HERBICIDES

Weed Beater® Plus Crabgrass & Broadleaf

Contact and systemic action. Kills grassy and broadleaf weeds like crabgrass, clover, chickweed, oxalis, dollarweed, spurge, foxtail and over 200 others. Not recommended for St. Augustine or Centipede grass type turf. Combines Quinclorac, 2,4-D and Dicamba for complete post emergent weed control, right down to the roots!

Not for sale in AK, HI, NY, SC, UT.



Item #	Desc	UPC	Vendor	CS/UOS	Location
80100048	32 oz. RTU	037321000655	065	12/12	East
80100259	32 oz. RTS	037321000662	066	12/12	East

Kleen Up HE Concentrate

Bonide KleenUP he Concentrate is a highly efficient, fast-acting, nonselective herbicide designed to kill over 200 types of weeds, brush, and grasses in one application. Starts working upon contact and kills down to the root so weeds won't grow back. This product is rainfast in just hours after application so it won't be washed away. **Not for sale in IN, ME, NY, WY**



Item #	Desc	UPC	Vendor	CS/UOS	Location
80101015	1 pt	037321007524	752	6/6	East
80101016	1 qt	037321007531	753	6/6	National
80101017	1 gal	037321007548	754	4/4	East

TRUSTED SINCE 1926
BONIDE®



KleenUp® HE RTU

Kills all unwanted weeds and grasses. Great for preparing flowerbeds, vegetable and ornamental garden sites, renovating lawns and for multipurpose weed control. Complete, to the root control in 2-4 weeks. Visible results in hours. **Not for sale in AZ, IN, ME, NY**

Item #	Desc	UPC	Vendor	CS/UOS	Location
80101018	32 Oz.	037321007579	757	6/6	National
80101019	1 Gal.	037321007586	758	4/4	East

KleenUp® 365

The fast-acting formula of KleenUp 365 makes it perfect for use on unwanted weeds & grasses. It kills the roots and all. Visible results will occur in 10 hours. This product is ideal for use on driveways, gravel areas, patios, parking areas, sidewalks, brick walkways, brick pathways, along fences, curbs, cracks in sidewalks, & more. One application of our weed preventer controls vegetation for up to 1 year. **Not for sale in AL, MD, PA, TX, VA**

Item #	Desc	UPC	Vendor	CS/UOS	Location
80100859	32 oz. RTU	037321007302	730	12/12	East
80100860	1 Gal RTU	037321007319	731	4/4	East

Captain Jack Deadweed Brew

Our herbicide provides fast-acting control of weeds, grass, mosses, & algae within hours. Captain Jack's Deadweed Brew is great for use on visible weeds within vegetable & flower gardens, landscaped areas, & lawns. It can also be used on visible weeds around & on buildings, sidewalks, fences, bark mulch, driveways, patios, & gravel. Approved and suitable for all of your organic gardening needs. **Not for sale in ME**

Item #	Desc	UPC	Vendor	CS/UOS	Location
80101050	RTU 32oz	037321026020	2602	6/6	National
80101049	Conc. 32oz	037321026013	2601	6/6	East

Captain Jack Lawnweed Brew

Derived from Iron, Captain Jack's Lawnweed Brew offers selective control of weeds, disease, moss, algae, and lichens in lawns. The active ingredient is derived from iron, which occurs in nature. Kills many common weeds like dandelion, clover, moss, narrow-leaved plantain, chickweed, and thistle. Works quickly, as dying weeds will be seen within hours of application. **Not for sale in CA, HI, IA, KS, NE, RI, SD**

Item #	Desc	UPC	Vendor	CS/UOS	Location
80101055	RTU 32oz	037321026105	2610	6/6	East
80101058	RTS 32oz	037321026129	2612	6/6	East
80101057	Conc. 32oz	037321026112	2611	6/6	East
80101061	RTU 128oz	037321026167	2616	4/4	East

Ground Force® Vegetation Killer

Kills all plant life, roots and all!. Prevents new growth for up to one full year. An excellent choice for driveways, patios, fence lines, gravel paths, parking areas, side walks, curbs. Higher concentrations than competitive brands. Imazapyr + Glyphosate.

Not for sale in AL, AK, DC, DE, HI, ND, PA, VA

Item #	Desc	UPC	Vendor	CS/UOS	Location
80100069	32 oz. Con.	037321051213	5121	12/12	East
80100070	1 gal. Con.	037321051312	5131	4/4	East

Brush Killer Bk-32

This powerful, non-volatile formulation works on the toughest weed species, yet is harmless to grass. It stays where you spray, without the danger of vapor damage or root uptake by surrounding trees and ornamentals. **Not for sale in AK, HI**

Item #	Desc	UPC	Vendor	CS/UOS	Location
80100066	16 oz. Con.	037321003304	330	12/12	East
80100166	32 oz. Con.	037321003311	3316	6/6	National

Chickweed, Clover & Oxalis Killer

Contains Horsepower® (Triclopyr + MCPA + Dicamba) Systemic action kills to the root. Compare and save. One pint treats 5,000 sq. ft., over 1½ times the competition. Plus, the label lists over 150 additional tough to control weeds. **Not for sale in AK, CA, HI, OK**

Item #	Desc	UPC	Vendor	CS/UOS	Location
80100202	16 oz. Con.	037321000617	061	12/12	East
80100203	32 oz. RTU	037321006121	0612	12/12	East

Sedge Ender

Incredibly effective pre and post emergent control of goosegrass, nutgrass (and all sedges), crabgrass, foxtail and many, many other problem grassy type weeds. Safe to use on both northern and southern lawns. Excellent cool weather performance. Sulfentrazone plus Proflaminate. 16 oz. treats 2,000–8,700 sq. ft. **Not for sale in AZ, CA, LA, NY, ND, DC**

Item #	Desc	UPC	Vendor	CS/UOS	Location
80100004	16 oz. Con.	037321000693	069	12/12	East

Weed-N-Feed

Popular product for care of grass and ornamental turf. No mixing. On/off switch for easy use. One quart treats 2,500 square feet. It contains 20-0-0 fertilizer plus 2,4-D and 2,4-DP. This product arrives in a container with an attached hose-end sprayer. Simply connect a garden hose to the sprayer and begin application. **Not for sale in FL, HI, DC**

Item #	Desc	UPC	Vendor	CS/UOS	Location
80100361	RTS 1 32oz	037321003014	301	12/12	West



CJ NeemMax RTU

4-In-1 Insecticide, Fungicide, Miticide & Nematicide. Cold pressed Neem Oil processed without chemicals. For residential use on listed crops including vegetables, fruits, citrus, nuts ornamental plants, lawns and other listed plants.

Not for sale in ID, MD, SD, VT, WY



Item #	Desc	UPC	Vendor	CS/UOS	Location
80101100	0.5 gal	037321020066	2006	6/6	East
80101134	1 gal	037321020080	2008	3/3	East

CJ Fruit Tree Spray

Concentrated formula is an excellent product for the home orchardist. Controls both insects, and diseases on fruit trees, flowers, evergreens, and strawberries. Only need as little as 1-1/2 tablespoons per gallon. Ideal for fungus and insect control. **Not for sale in ID, ME, MI, NJ, SD, VT**



Item #	Desc	UPC	Vendor	CS/UOS	Location
80101101	Conc Pint	037321020028	2002	6/6	National
80101102	Conc Quart	037321020035	2003	6/6	National

Weed Beater® ULTRA

The ultimate systemic broadleaf weed killer for lawn and turf. New chemistry that's especially effective on over 200 hard-to-kill weeds, right to the roots. Visible results in just 24 hours! Rainfast once dry. Reseed in just two weeks. Superior cool-weather performance down to 45°F extends application window to early spring and late fall, when weeds are most susceptible. Non 2, 4-D formula contains MCPA, Mecoprop-p, Dicamba and Carfentrazone. 16 oz. concentrate treats up to 21,000 sq. ft. in the South and 10,000 sq. ft. in the North. Ready to use formula contains "See Spray" non-staining blue marker dye. **Not for sale in AK, HI. 16 oz. Con. not for sale in VT**



Item #	Desc	UPC	Vendor	CS/UOS	Location
80100065	16 oz. Con.	037321003090	309	6/6	National
80100023	16 oz. RTS	037321003120	312	12/12	East
80100022	32 oz. RTU	037321003076	307	12/12	National

CJ Deadweed Brew

Captain Jack's Deadweed Brew is great for use on visible weeds within vegetable and flower gardens, landscaped areas, and lawns. It can also be used on visible weeds around and on buildings, sidewalks, fences, bark mulch, driveways, patios, and gravel. Approved and suitable for all of your organic gardening needs. **Not for sale in ME, NM**



Item #	Desc	UPC	Vendor	CS/UOS	Location
80101048	16 oz Con.	037321026006	2600	6/6	East
80101052	128oz Con.	037321026037	2603	4/4	East

Wilt Stop

Popular product for care of grass and ornamental turf. No mixing. On/off switch for easy use. One quart treats 2,500 square feet. It contains 20-0-0 fertilizer plus 2,4-D and 2,4-DP. This product arrives in a container with an attached hose-end sprayer. Simply connect a garden hose to the sprayer and begin application.



Item #	Desc	UPC	Vendor	CS/UOS	Location
80100205	40oz. RTU	037321000990	99	12/12	West

COMBOS

Turbo Spreader Sticker

Bonide Turbo Spreader Sticker is a biodegradable, combination spreading, sticking and penetrant agent designed to provide better distribution and adhesion of all types of insecticides, herbicides, and fungicides.

Not for sale in CA



Item #	Desc	UPC	Vendor	CS/UOS	Location
80100151	8oz.	037321000976	97	12/12	West

Citrus Fruit & Nut Orchard Spray

This all natural, all in one, insect and disease control concentrate is perfect for those customers that prefer a natural choice. Great for citrus, fruit and nuts, and also vegetables, ornamentals, houseplants and lawns. Truly effective and all purpose. Use as little as 2 1/2 oz./gal. Available in convenient, no-mix ready-to-spray bottles for easy application to trees and larger areas. **Not for sale in DC**



Item #	Desc	UPC	Vendor	CS/UOS	Location
80100161	16 oz. Con.	037321002178	217	12/12	National
80100160	32oz RTS	037321002161	216	12/12	National
80101041	32oz Con.	037321002185	2186	6/6	National

Pruning Sealer Aerosol

A superior protective seal for pruned, grafted or damaged trees, roses or shrubs. Contains an antiseptic and a sealant to kill and keep out infections and insects. Won't burn or run. Also can be used to waterproof planting pots, wooden tubs, canvas. Brown to blend with tree bark.



Item #	Desc	UPC	Vendor	CS/UOS	Location
80100013	14 oz.	037321002215	221	12/12	National



Rose Rx 4-in-1 Concentrate

Rose Rx (4-in-1), insecticide, fungicide, miticide for organic gardening. Controls plant disease, mites and all stages of insect life cycles. Use on roses, flowers and more. **Not for sale in ID, ND, OK, PR, DC**



Item #	Desc	UPC	Vendor	CS/UOS	Location
80101135	16 oz Con.	037321008170	817	6/6	East

Rose Shield Systemic Rose & Flower Drench

Bonide Rose Shield is very protective and will shield your roses from insects and disease for six weeks. This product can also be used on full flowerbeds as well as azaleas, camellias, and other shrubs. This product will protect your flowers from Japanese beetles, borers, aphids, black spot, powdery mildew, rust, and much more.

Not for sale in CA, CT, MD, MA, NY, VT



Item #	Desc	UPC	Vendor	CS/UOS	Location
80101025	40oz.	037321009474	947	6/6	West

Rose Shield

Lambda-Cyhalothrin kills bugs on contact and by ingestion. Thiamethoxam is absorbed by the plant, and moves rapidly throughout, killing insects from within. Difenoconazole, a contact & systemic fungicide, works from within the plant as well, stopping existing, and preventing new plant disease. A great solution for insect and disease problems for roses, flowers, landscape plants, trees, shrubs and ground covers. Lasts up to 30 days. Rain proof within 60 minutes.

Not for sale in CT, MD, MA, NY, PR, VT



Item #	Desc	UPC	Vendor	CS/UOS	Location
80100706	32 oz. RTU	037321009825	982	12/12	National

Rose Shield Insect & Feed

Systemic insecticide plus fertilizer for roses, flowers, and shrubs. Granular formula promotes strong roots and blooms while protecting plants against insect damage for up to 8 weeks. (1) 6 lb container treats up to 48 rose bushes or 300 square feet. Works to the roots and protects from the inside. This product kills Adelgids, Aphids, Fungus gnats and many more listed insects. **Not for sale in CA, CT, MD, MA, VT, NY, LA, ME, NV, NJ, RI, SD**



Item #	Desc	UPC	Vendor	CS/UOS	Location
80101023	6lb. Granular	037321009467	946	4/4	East

Fruit Tree & Plant Guard

This goof proof water based combination is economical, versatile and has a very broad spectrum. Only 2 oz./gal. treats not only a comprehensive listing of fruit, but also nuts, flowers, shrubs and ornamentals. Available in concentrate, including our "Twist and Shoot" RTS for convenient tall tree spraying. Contains actives: Lambda Cyhalothrin, Pyraclostrobin, and Boscalid. **Not for sale in IA**



Item #	Desc	UPC	Vendor	CS/UOS	Location
80100679	16 oz. Con.	037321020219	2021	6/6	East
80100683	16 oz. RTS	037321020615	2061	12/12	East

Fruit Tree and Plant Guard Concentrate

Fruit Tree and Plant Guard is an easy, versatile and effective way to control and prevent listed insects and disease on fruit, nuts, ornamental trees, shrubs & flowers. Perfect for the novice or master orchardist. Protect Apples, Cherries, Peaches, Pears and more. Controls Powdery Mildew, Apple Scab, Fly Speck and more.



Item #	Desc	UPC	Vendor	CS/UOS	Location
80100680	1 qt Conc	037321020318	2031	6/6	East

INSECTICIDES

Revenge Wasp & Hornet

Provides instant knockdown, quick kill, and residual action that takes out the entire nest and prevents re-nesting. Jet spray shoots 20 feet. Works on yellow jackets, wasps, carpenter bees, and hornets. **Foam not for sale in AZ, ID, ME, NJ Aerosol not available for sale in AZ, CA, NJ, OR, RI**



Item #	Desc	UPC	Vendor	CS/UOS	Location
80101123	Foam 15oz.	037321046431	4643	12/12	National
80101122	Aerosol 15oz.	037321046530	4653	12/12	West

Mosquito Beater Plunks

Water soluble pouches provide the perfect delivery system for this natural mosquito larvicide. Upon dissolving, thousands of floating granules quickly and evenly release the Bti active ingredient across the surface of any standing water. **Not for sale in WA, DC.**



Item #	Desc	UPC	Vendor	CS/UOS	Location
80100073	2 oz. / 24pk	037321005490	549	12/12	National



Annual™ Tree & Shrub Insect Control

One application kills insects, and prevents new infestations for an entire year. No spraying, just mix and pour at the base of the plant. Systemic insecticide is absorbed through the roots to all parts of the plant, even new growth, and won't wash off. For use on listed fruit, nut and ornamental trees and shrubs. Kills borers (including Emerald Ash Borer & Asian Longhorned Beetle), adelgids, miners, whitefly, scale, beetles, weevils. Contains 1.47% Imidacloprid.

Not for sale in CT, ME, MD, MA, NV, NJ, NY, PR, RI, VT

Item #	Desc	UPC	Vendor	CS/UOS	Location
80100126	32 oz. Con.	037321006091	609	12/12	East
80100127	1 gal. Con.	037321006114	611	4/4	National

Thuricide Bacillus Thuringiensis

Contains BT Kurstaki 15%, a liquid formulation of bacteria. Controls caterpillars, loopers, cabbageworms, hornworms, leaf folders and leaf rollers. One pint treats up to 10,875 sq ft. Won't harm beneficial insects.

Item #	Desc	UPC	Vendor	CS/UOS	Location
80100239	8 oz. Con.	037321008026	802	12/12	East

Slug Magic® Pellets

Patented, rain proof formula makes slugs disappear! Can be used around pets and wildlife. Slug Magic can be used in fruit and vegetable gardens up to the day of harvest. 1.0% iron phosphate pellets.

Item #	Desc	UPC	Vendor	CS/UOS	Location
80100638	1 lb.	037321009030	903	12/12	East
80100144	24 oz.	037321009047	904	12/12	East
80100040	3 lb.	037321009054	905	12/12	East

Eight® Flower & Vegetable Granules

Outstanding surface and subsurface insect control, specifically designed for vegetable and flower garden use. One application provides season long control (three months). A partial listing of insects and crops include: wireworms, seed maggots, weevils, cutworms, billbugs, armyworms, mole crickets and cranefly on beans, peas, melons, squash, tomatoes, lettuce, peppers and broccoli. The label includes many more. Use 1lb. per 500 sq. ft. Contains Bifenthrin .115%. **Not for sale in AK, HI**

Item #	Desc	UPC	Vendor	CS/UOS	Location
80100037	3 lb.	037321007883	788	12/12	East

BT Thuringide Spray

Controls destructive worms, and caterpillars in and around vegetable and flower gardens. Has no effect on birds, earthworms or beneficial insects such as honey bees and lady bugs. May be used on edibles right up to the day of harvest.

Item #	Desc	UPC	Vendor	CS/UOS	Location
80100862	32 oz. RTU	037321008064	8066	6/6	East
80101077	16 oz Con.	037321008033	8036	6/6	East

Eight® Garden Dust

An outstanding vegetable garden insecticide that kills and repels most insect pests common to home gardens. Provides contact and residual control of over 55 hard to kill insects. Designed for use on vegetables, roses and flowers. Easy to use and one application can last up to 4 weeks. **Not for sale in AK, HI**

Item #	Desc	UPC	Vendor	CS/UOS	Location
80100035	10 oz. Puff	037321007845	784	12/12	East
80101076	3lb	037321007869	7866	6/6	East

Japanese Beetle Killer

Natural pyrethrum for quick and easy kill of Japanese Beetles and many other insects. **Not for sale in AK, AZ, CA, HI, ID, MT, NM, ND, OR, SD, UT, WA, WY, DC**

Item #	Desc	UPC	Vendor	CS/UOS	Location
80100152	32 oz. RTU	037321001966	196	12/12	East

Systemic Granules Insect Control

Convenient, ready-to-use granules provide effective, long lasting insect control for 8 weeks. Excellent indoor no odor, no spray, no mess formula. Systemic action moves throughout the plant, even protecting new growth. Kills tough houseplant pests like fungus gnats, mealybug, whitefly, thrips and aphids. Contains Imidacloprid 0.22%. **Not for sale in CT, D.C, MA, MD, NY, PR, VT, ME, NJ**

Item #	Desc	UPC	Vendor	CS/UOS	Location
80100148	1 lb.	037321009528	952	12/12	East
80101092	4lb.	037321095347	95349	9/9	East

Bug & Slug Killer

Bug & Slug Killer is a bait that attracts and kills snails, slugs and other crawling garden insects. Approved for organic gardening. Use to protect listed vegetables, fruits and berries.

Item #	Desc	UPC	Vendor	CS/UOS	Location
80101090	1.5 lb	037321009085	9086	6/6	East

2024

TRUSTED SINCE 1926
BONIDE®



All Seasons® Horticultural Spray Oil

A superior type paraffinic oil that may be used as a growing season spray, dormant spray (no leaves) or delayed dormant (green tip) spray to control over wintering eggs of red spiders, scale insects, aphids, bud moths, leaf roller, red bug, codling moth, blister mites, galls, whitefly, mealy bugs and other insects. Highly recommended for use on fruit trees, shade trees, shrubs, ornamentals, roses and vegetables. **RTU: Not for sale in HI.**

Item #	Desc	UPC	Vendor	CS/UOS	Location
80101039	16 oz Con.	037321002109	2106	6/6	National
80100059	32 oz. RTU	037321002147	214	12/12	National
80100058	32 oz. RTS	037321002130	213	12/12	East
80101040	32 oz Con.	037321002116	2116	6/6	East

Tomato & Vegetable 3-1

This product is designed to kill species of aphid, spider mite, ant, cricket, weevil, caterpillar, fly, thrip, silverfish, & more. Tomato & Vegetable spray controls blackspot, powdery mildew, rust, scab, blight, brown rot, & leaf spot. For best control apply as a protective spray early in the season before the diseases are noticed. Our insect killer is perfect for use on listed fruits, vegetables, & ornamentals. This product is conveniently ready to use when it arrives at your door.

Item #	Desc	UPC	Vendor	CS/UOS	Location
80101073	32 oz RTU	037321006886	6886	6/6	National

MITE-X

A broad spectrum, effective indoor/outdoor mite control on vegetables, fruit, nuts, vine crops, shrubs, berries, herbs, spices, ornamentals, evergreens, greenhouse plants and interior plants. Safe for use around children and pets. Made from botanical extracts. Also kills aphids and thrips. Pleasant odor. A specific miticide for houseplants. Also kills aphids and thrips.

Item #	Desc	UPC	Vendor	CS/UOS	Location
80100359	32 oz. RTU	037321002857	285	12/12	East

Systemic Insect Control

Economical, long lasting insect control for ornamental gardens, shrubs and trees. Use as little as 2 tablespoons/gal. Acephate 9.4% Concentrate. neonic alternative chemistry. **Not for sale in CA, LA, HI.**

Item #	Desc	UPC	Vendor	CS/UOS	Location
80100042	16 oz. Con.	037321009412	941	12/12	East

Colorado Potato Beetle Beater

Contains Spinosad .5% Controls the tough CO Potato Beetle larvae, as well as selected leaf beetle larvae and adults - naturally. For organic production. **Not for sale in AK, AZ, CA, CO, HI, ID, MT, NV, NM, ND, OR, SD, UT, WA, WY, DC**

Item #	Desc	UPC	Vendor	CS/UOS	Location
80100579	16 oz. Con.	037321006879	687	12/12	East

Captain Jack's Deadbug Brew™

Captain Jack's Deadbug Brew® contains Spinosad. Deadbug Brew kills bagworms, borers, beetles, caterpillars, codling moth, gypsy moth, loopers, leaf miners, spider mites, tent caterpillars, thrips and more! Use on fruits, vegetables, berries, citrus, grapes, nuts and ornamentals. Captain Jack's Dust. **Not for sale in AK, HI**

Item #	Desc	UPC	Vendor	CS/UOS	Location
80101045	16 oz Con.	037321002529	2526	6/6	National
80101044	32 oz RTU	037321002505	2506	6/6	National
80100353	32 oz. Con.	037321002536	253	12/12	East
80100354	32 oz. RTS	037321002550	255	12/12	East
80101046	1.5lb Dust	037321002574	2576	6/6	East
80101047	4lb	037321002581	2586	6/6	East

Systemic Rose & Flower Care

2-in-1 Systemic Insecticide plus 8-12-4 Fertilizer for roses, flowers, and shrubs. Systemic Rose & Flower is specifically formulated to provide up to 8 Weeks of insect control, as well as essential macro plus micro nutrients. Convenient granules. Great for container gardens. Contains 0.22% Imidacloprid. **Not for sale in CT, Long Island, NY, LA, MA, ME, MD, NV, NJ, RI, SD, and VT**

Item #	Desc	UPC	Vendor	CS/UOS	Location
80101091	2lb	037321009443	9446	6/6	East

Eight® Garden & Home

Controls over 130 different insect pests on fruits, roses, flowers, lawns, shrubs, trees and over 60 varieties of ornamentals. No odor, water based, indoor/outdoor. Contains Lambda-cyhalothrin insecticide.

Not for sale in AK, HI

Item #	Desc	UPC	Vendor	CS/UOS	Location
80100068	32 oz. RTU	037321004288	428	12/12	National

Malathion 50E Concentrate

Malathion Insect Control concentrate is labeled for use on houseplants, vegetables, fruits, and ornamentals to control a variety of insects.

Not for sale in AK, CA, HI.

Item #	Desc	UPC	Vendor	CS/UOS	Location
80101094	32 oz Con.	037321009931	9936	6/6	East

TRUSTED SINCE 1926
BONIDE



Diatomaceous Earth

For indoor/outdoor insect control In homes, barns, stables, vegetable and flower gardens. Dual mechanical mode of action works by contact and by ingestion. Insects cannot become immune to its action. Bedbugs, Asian lady beetles, box elder bugs, mites, ants, flies, fleas, spiders, other beetles and crawling insects all succumb within 24-48 hours of contact. Apply as a dust or a slurry.

Item #	Desc	UPC	Vendor	CS/UOS	Location
80100848	1.3 lb. jug	37321001201	120	12/12	National
80100711	5 lb.	037321001218	121	8/8	National

Eight® Yard & Garden

Permethrin 2.5% Non-staining, water based. Use as a general home and grounds spray to keep out invading ants, ticks, mosquitoes, fleas, flies... can be used directly on homes, patios, porches, garages... Controls over 100 insects on fruit, nuts, vegetables, flowers, trees, shrubs, roses and also kills stink bugs. **Not for sale in AK, HI**

Item #	Desc	UPC	Vendor	CS/UOS	Location
80100167	32 oz. RTS	037321004264	426	12/12	East

Pyrethrin Garden Insect Spray

Natural pyrethrin in a concentrated formula for economical, natural, broad spectrum garden insect control. Ideal for vegetables, fruits, flowers and delicate ornamentals. Use up to the day of harvest.

Not for sale in CA, DC

Item #	Desc	UPC	Vendor	CS/UOS	Location
80100617	8 oz. Con.	037321008576	857	12/12	East
80100618	32 oz Con.	037321008583	858	12/12	East

Eight® Vegetable, Fruit & Flower

Provides economical, contact and residual insect control for up to 4 weeks. Kills over 100 insects which destroy lawns, roses, flowers, trees, shrubs, vegetables, fruit, nuts, and may be applied to homes and other areas to stop infestations of flies, ticks, fleas, mosquitoes, ants... all flying, crawling & hopping insects. Even great for houseplants! Contains 2.5% Permethrin. **Not for sale in AK, HI.**

Item #	Desc	UPC	Vendor	CS/UOS	Location
80100027	16 oz. Con.	037321004424	442	12/12	National
80100412	32 oz. Con.	037321004431	443	12/12	East

Malathion Insect Control

50.0% Cythion. A truly all-purpose insecticide. Labeled for use on fruits, vegetables and ornamentals. 16 oz. makes up to 50 gal. of spray.

Not for sale in AK, CA, HI



Item #	Desc	UPC	Vendor	CS/UOS	Location
80100045	16 oz. Con.	037321009924	992	12/12	National

Ant, Flea & Tick Granules

0.25% Permethrin. Fast acting, long lasting (4 weeks) insect control for lawns and home foundations. Great for ants, fire ants, fleas, ticks, crickets, earwigs, spiders, sowbugs, silverfish, clover mites, chinch bugs, armyworms, sod webworm, leaf hoppers, millipedes and certain grubs.

Not for sale in AK, HI



Item #	Desc	UPC	Vendor	CS/UOS	Location
80100124	10 lb.	037321606130	60613	4/4	East

Revenge Ant Bait Stations

Pre-filled liquid ant bait stations for control of sweet, grease, Argentine and Carpenter Ants. Also kills roaches. Large 0.75 oz. bait stations with 1% low-dose formula for best control of large/multiple colony problems. Indoor/Outdoor use.

Not for sale in AK, DC, HI



Item #	Desc	UPC	Vendor	CS/UOS	Location
80100168	3 Pk.	037321451006	45100	12/12	East

Ant & Roach Killer

Weather resistant formula granules kill ants before they become a problem in your house. Kills within 24 hours. Quick acting killer can also be used indoors for ant control. Kills both sweet and grease eating ants, kills the entire colony, kills roaches, crickets, mole crickets, slugs, snails, earwigs and silverfish. **Not for sale in AK, CA, CO, CT, DE, HI, ID, IL, IN, IA, KS, ME, MD, MA, MI, MN, MO, MT, NE, NV, NH, NJ, NY, ND, OR, PA, SD, UT, VT, WA, WY, DC**



Item #	Desc	UPC	Vendor	CS/UOS	Location
80100170	1lb. Dust	037321455028	45502	12/12	West
80100171	1.5lb. Granules	037321456025	45602	12/12	West



Super Soap

Spinosad .005% plus potassium salts of fatty acids 1.94% fast acting patented formula for organic gardening to kill over 30 insects and mites on vegetables, fruit, nuts, berries, herbs, container plants, greenhouse plants, and ornamentals. Also kills powdery mildew.

Item #	Desc	UPC	Vendor	CS/UOS	Location
80100926	32 oz RTU	037321006558	6556	6/6	National

Insecticidal Soap

Potassium fatty acids from plants kill insects on contact. Great for houseplants, vegetables, flowers, fruits. Patented formula does not persist in the environment and may be used up to day of harvest. Preferred by organic gardeners. Contains no flammable solvents or animal fatty acids like other brands. **Not for sale in HI.**

Item #	Desc	UPC	Vendor	CS/UOS	Location
80101098	32 oz. RTU	037321006527	6526	6/6	National

Bon-Neem II®

A broad spectrum fungicide, insecticide and miticide for control of insects, diseases and mites on vegetables, fruit, nuts, herbs, spices, roses, flowers, shrubs, houseplants, shrubs and more around the home. Kills stink bugs, boxelder bugs, fungus gnats plus Brown Patch, Dollar Spot (on Turf) and Snow Mold to name just a few.

Item #	Desc	UPC	Vendor	CS/UOS	Location
80100245	32 oz. RTU	037321000259	025	12/12	East

Neem Oil - Organic

An all purpose insecticide, miticide and fungicide for organic gardening. Derived from the Neem seed, Neem oil is an excellent choice for use on virtually any plant, including roses, flowers, vegetables, herbs, spices, houseplants, trees, turf and shrubs. Kills all stages of insects - eggs, larvae and adults. Makes a great dormant spray. Imparts a healthy shine to hardy leaf surfaces. Comes in an economical concentrate and convenient ready to use.

Item #	Desc	UPC	Vendor	CS/UOS	Location
80100003	16 oz. Con.	037321000242	024	12/12	East
80101033	32 oz RTU	037321000228	226	6/6	National
80100949	1 gal RTU	037321000235	023	4/4	National

Neem Max Conc.

Neem Max is an organic plant-based, botanical product that contains the full spectrum of bioactive compounds that stops the insect lifecycle. This 4-in-1 product is a Fungicide, Insecticide, Miticide & Nematicide. Apply as a spray or as a drench to protect your plants from insects and diseases. **Not for sale in AZ, WY, PR**



Item #	Desc	UPC	Vendor	CS/UOS	Location
80101032	8oz Con.	037321000204	20	12/12	East
80101141	8oz RTU Houseplants	037321001171	117	12/12	East
80101034	16 oz Con.	037321000266	26	6/6	National

Mosquito Beater® Repellent

Residual formula repels mosquitoes, gnats, flies and other nuisance insects for up to 2 weeks. Made with natural ingredients. Great for lawns, patios, gardens, barns....Any outdoor area. Pleasantly scented. 1 quart treats 5000 sq. ft. Convenient, no-mix ready-to-spray applicator. **Not for sale in IN, KS, DC**



Item #	Desc	UPC	Vendor	CS/UOS	Location
80100183	Fogger 15oz.	037321005605	560	12/12	West
80100074	4m Granular	037321056126	5612	12/12	West
80101072	32 oz RTS Killer	037321006800	6806	6/6	National
80101069	32 oz RTS	037321005643	5646	6/6	West

Spider & Ground Bee Killer

Kills and repels. Our pest control is great for use on a variety of bug species including ant, spider, roach, cricket, mite, silverfish, wasp, bee, hornet, & more. Designed for indoor & outdoor use. Includes applicator cap for hard to reach areas.

Not for sale in CA, MD, WA



Item #	Desc	UPC	Vendor	CS/UOS	Location
80101132	10oz.	037321046844	4684	12/12	West

Spider Killer

Kills spiders on contact. This long-lasting non-staining formula also kills palmetto bugs, stink bugs, Asian lady beetles, and other listed insects. Water-based formula leaves no unpleasant odor or staining in carpets or floors. **Not for sale in AZ, ME, OR, RI**



Item #	Desc	UPC	Vendor	CS/UOS	Location
80101120	1 gal RTU	037321046868	4686	4/4	West



Revenge Flea Fogger

Flea Fogger prevents fleas from developing into the biting adult stage. It also kills other species of insects including cockroaches, brown dog ticks, spiders, ants, & other listed insects. It does not control bed bugs. **Not for sale in AZ, ID, ME, PR**



Item #	Desc	UPC	Vendor	CS/UOS	Location
80101121	6oz.3pk.	037321046134	4613	12/12	West

Termite & Carpenter Ant Killer

Indoor/Outdoor formula termite and carpenter ant killer. Contact kill provides immediate results when spraying insects directly. Powerful, long-lasting Deltamethrin provides indoor or outdoor protection from carpenter ants and other wood infesting insects when they return to treated areas. **Not for sale in AZ, FL, ME, PR**



Item #	Desc	UPC	Vendor	CS/UOS	Location
80101119	Aerosol 15oz.	037321046233	4623	12/12	West
80101115	32 oz RTU	037321046202	4620	6/6	West

House Guard

Kills roaches, ants, bedbugs, fleas, spiders and ticks. Expanding Foam Spreads deep into hard to reach places. Keeps killing roaches for up to 18 months. Non-Staining formula does not stain where you put it. **Not for sale in DC, ME, TX**



Item #	Desc	UPC	Vendor	CS/UOS	Location
80101014	Aerosol 15oz.	037321466406	46640	12/12	West
80101130	32 oz RTU	037321046509	4650	6/6	West
80101012	1 gal RTU	037321465409	46540	4/4	West

Bedbug Killer

Kills bedbugs and their eggs. Kills even pyrethroid-resistant bedbugs. The fast-acting formula lasts up to 2 months on laminated wood surfaces. It also kills fleas, listed ticks, ants, spiders, stink bugs, box elder bugs and may more home invading insect pests. Premium, non-staining formula. **Not for sale in ME, NJ, PR**



Item #	Desc	UPC	Vendor	CS/UOS	Location
80101125	32 oz RTU	037321046707	4670	6/6	West

REPELLENTS

Gophertox®

REVENGE® Gophertox® Gopher Killer is a poison bait to kill pocket gophers in your lawn. This product helps protect flower bulbs in the fall and can be used on lawns. **Not for sale in NH, PR**



Item #	Desc	UPC	Vendor	CS/UOS	Location
80100592	1lb	037321006954	695	12/12	East

Moletox II

Effectively kills moles and pocket gophers. Crack corn based bait can be place in an active run or tunnel. Can also be used to protect flower bulbs by using Bonide Moletox II around the bulb and covering with soil. 1# container. **Not for sale in NH**



Item #	Desc	UPC	Vendor	CS/UOS	Location
80100234	1 lb	037321006985	698	12/12	East

Go Away! Rabbit, Dog, & Cat Repellent

Go Away! Rabbit, Dog & Cat Repellent Granules by Bonide effectively and naturally repel animals and deter them from forbidden areas in your yard, lawn and garden. Use this product as a training aid! While this product is an animal behavior modification tool, it may need to be supplemented with other behavior modification techniques to break domestic animals and pets of existing bad habits. **Not for sale in IN, ME, NM**



Item #	Desc	UPC	Vendor	CS/UOS	Location
80100196	1.5lb	037321008705	870	12/12	West

Snake Repellent

Repel snakes and other pests from your yard and garden with Snake Stopper Snake Repellent Granules from Bonide! Natural ingredients keep snakes away from your yard by triggering their escape and avoidance behavior, without causing any harm! Cinnamon Oil, Cedarwood Oil, and Clove Oil create a strong smell and taste to naturally deter snakes, iguanas and lizards. **Not for sale in AK, DC**



Item #	Desc	UPC	Vendor	CS/UOS	Location
80100627	1.5lb	037321087519	8751	12/12	West

TRUSTED SINCE 1926
BONIDE®



Repels-All® Granules

A convenient granular formulation of the all-natural and popular Repels-All® liquid. Triggers genetically and biologically ingrained fear and flight responses in a multitude of animal intruders - without harm. Lasts up to 2 months. Protects plants and property - year round. Organic and biodegradable. **Not for sale in IN, NM, VT**

Item #	Desc	UPC	Vendor	CS/UOS	Location
80101095	1.25 lb.	037321023609	23606	6/6	National
80101096	3 lb.	037321023616	23614	4/4	National
80100016	6 lb.	037321023623	2362	4/4	East

Repels-All®

All natural ingredients. Repels three ways: by sense of touch, taste and smell. Protects plants and property including structures for up to 2 months per application. Rain fast after 6 hours. Most comprehensive animal repellent available. Contains garlic, dried blood, whole egg solids, clove, fish oil, onion and wintergreen.

Not for sale in IN, NM, VT

Item #	Desc	UPC	Vendor	CS/UOS	Location
80101097	32 oz. Con.	37321002376	2376	6/6	National
80101043	32 oz RTS	037321002406	2406	6/6	East

MoleMax®Sonic Spike

Exclusive "Chatter Sound" technology mimics predator warning. Effective on most burrowing rodents. Superior components for year -round use. Patented "open wave" tip for maximum sound release. Normal "C" cell battery version designed for 18 month extended battery life. **Not for sale in OK, WY, DC**

Item #	Desc	UPC	Vendor	CS/UOS	Location
80100967	Spike	037321611189	61120	6/6	East

MoleMax® Granules

Mole and vole repellent granules and bulb protector. Repel moles, voles, gophers, rabbits, armadillos, skunk... in lawns, flower beds, gardens... Clean, dustless, biodegradable granules are safe for use around children, plants and pets. 1 lb. treats 500 sq. ft. and lasts up to 3 months. Contains Rucinus Communis Oil. **Not for sale in IN, WI, DC**

Item #	Desc	UPC	Vendor	CS/UOS	Location
80101074	5lb	037321006916	6914	4/4	National
80100194	10 lb. Bag	037321006923	692	4/4	National

MoleMax® RTS

MoleMax® repels moles, voles, gophers, rabbits, and other listed rodents. Lasts up to 3 months, when used as directed. It penetrates deep into the soil where animals burrow for maximum efficacy.

Not for sale in IN, NM, WI, DC

Item #	Desc	UPC	Vendor	CS/UOS	Location
80100586	32 oz	037321006909	690	12/12	East

Moletox Mole & Gopher Killer

This mole and gopher killer protects your lawn from unsightly mounds and ridges. Economical - one tsp. treats an active burrow or tunnel. Zinc phosphide on cracked corn. Excellent bait acceptance. **Not for sale in DC, NH.**

Item #	Desc	UPC	Vendor	CS/UOS	Location
80100133	8 oz.	037321006978	697	12/12	East

Rat Magic®

The perfect sister product to our popular Mouse Magic, Rat Magic® is designed for outdoor use to repel rodents such as rats, chipmunks and squirrels. This unique combination of essential oils is people and pet safe, and biodegradable. 5lbs. treats up to 1000 sq. ft. or a 2 ft. barrier that's 500 ft. long. **Not for sale in IN, MD, NM**

Item #	Desc	UPC	Vendor	CS/UOS	Location
80101084	5lb	037321008637	8634	4/4	East

Mouse Magic®

The all natural ingredients in Mouse Magic triggers "escape/avoidance" behaviors in mice driving them from homes, sheds, and patios. Simply locate "place packs", which exude the repelling quality of the essential oils, any where mice enter, feed or nest. Repels for over 30 days in laboratory tests. **Not for sale in DC, IN, NM, VT**

Item #	Desc	UPC	Vendor	CS/UOS	Location
80100153	4 pk.	037321008651	865	12/12	National
80100243	12 Pk.	037321008668	866	6/6	East

Bat Magic®

Drives bats from attics, blinds, wall voids, chimneys, and other confined spaces they like to hide in. Contains natural, essential oils packaged in convenient simple to use "place packs". **Not for sale in IN, NM, WI, DC**

Item #	Desc	UPC	Vendor	CS/UOS	Location
80100631	4 pack	037321008767	876	12/12	East

2024



Chipmunk, Squirrel, Rodent Repellent

Naturally drive rats, chipmunks, squirrels and other rodents from premises, around homes, barns, stables, patios, garages, trash cans, wood piles. Biodegradable and people & pet safe.

Not for sale in AK, CT, DC, IN, KY, ME, MS, NM, NV, SD.



Item #	Desc	UPC	Vendor	CS/UOS	Location
80100928	32 oz RTS	037321008682	868	6/6	East

Shot-Gun Repels-All Animal Repellent Rtu

Deer and Rabbit Repellent protects flowers, shrubs, vegetables, fruit, bulbs, lawns, trees... from deer, rabbits, squirrels...both an odor and a taste barrier. All natural ingredients. Leaves no noticeable residue. Lasts 3 months. Contains putrescent whole egg solids, garlic and capsaicin. **Not for sale in IN, NM, VT**



Item #	Desc	UPC	Vendor	CS/UOS	Location
80101099	32 oz RTU	037321002383	2386	6/6	National

Hot Pepper Wax Animal Repellent

A natural repellent for use on fruits, vegetables and ornamentals. Even stops animals from chewing wood structures and fences. One application can last up to 4 weeks. Made from hot cayenne peppers. **Not for sale in AK.**



Item #	Desc	UPC	Vendor	CS/UOS	Location
80100274	32 oz. RTU	037321001270	127	12/12	East

Go Away! Deer & Rabbit Repellent

The formula used to create the granules does not act as a poison, and it will not harm the animals. It is safe to use this product around areas where children play as long as it is used as directed. It is perfect for deterring animals as the scent is unpleasant to them and keeps them away from the area. Use this product exactly as directed for optimal protection. One container can treat up to 900 Square Ft. **Not for sale in AL, IN, ME, NM, OH**



Item #	Desc	UPC	Vendor	CS/UOS	Location
80101042	32oz.	037321002307	2306	6/6	National
80100346	Gran.3lb.	037321002277	227	12/12	East

SPECIALTY



Rot-Stop® Concentrate

Nutritional Calcium corrects calcium deficiency. Controls blossom end rot on tomatoes, other vegetables. Apply to developing fruit and foliage after periods of heavy rain or rapid growth. 4 tbsp./gal.

Not for sale in MD, WI

Item #	Desc	UPC	Vendor	CS/UOS	Location
80100211	8 oz. Con.	037321001669	166	12/12	East
80101036	32 oz RTU	037321001676	1676	6/6	National

Tomato & Blossom Set Spray

Makes blossoms set fruit despite poor weather. Nearly every blossom will produce larger, meatier, almost seedless tomatoes, ripening up to 3 weeks earlier. Also for use on other vegetable plants! Contains natural plant growth hormone Kinetin. **Not for sale in CA, HI, NM**

Item #	Desc	UPC	Vendor	CS/UOS	Location
80101067	8 oz RTU	037321005438	5436	6/6	National

Stump-Out

BONIDE Stump-Out® accelerates the decomposition of seasoned tree stumps to allow them to easily be burned out or chopped out of the ground. Works in 4 - 6 weeks.

Item #	Desc	UPC	Vendor	CS/UOS	Location
80101063	1lb Granules	037321002727	2726	6/6	National

Poison Ivy & Oak Killer

BONIDE Poison Ivy & Oak Killer is a systemic weed killer designed to control weeds to the root. It won't harm lawngrass and is safe and effective to use when used as directed. Product is rainfast after application is dry. **Not for sale in AK, AZ, CA, CO, HI, ID, MT, NM, ND, OR, SD, UT, WA, WY**

Item #	Desc	UPC	Vendor	CS/UOS	Location
80101066	32 oz RTU	037321005063	5066	6/6	East

Stump & Vine Killer

Kills stumps and vines without harming turf. Contains brush applicator for an easy application. Kills poison oak, poison ivy and more. **Not for sale in AK, HI, VT**

Item #	Desc	UPC	Vendor	CS/UOS	Location
80101064	8 oz Con.	037321002741	2746	6/6	National

TRUSTED SINCE 1926 BONIDE® TRAPS

Beetle Bagger™ Japanese Beetle Trap

These irresistible, dual Floral/Pheromone lure system protects 5,000 sq. ft., all season long! The hourglass shaped disposable collection bags trap beetles securely. Attractive display box goes anywhere - shelf displays, counter tops, peg hook displays. Each kit contains 1 trap, 1 dual-lure and 2 collection bags.

Not for sale in DC. **Not for sale in AK, AZ, CA, HI, ID, MT, NV, NM, ND, OR, UT, WA, WY, DC**



Item #	Desc	UPC	Vendor	CS/UOS	Location
80100055	Trap Kit	037321001973	197	24/24	East
80100010	Trap Lures	037321019725	1972	12/12	East
80100009	Bags 6/pk	037321019718	1971	24/24	East

2024

Revenge® Moth Traps

Insect Traps with Pheromone Lure, Attracts and captures pantry pests. For kitchens, cupboards, pet food, bird seed. Non-toxic and odorless. Lasts for 3 months.

Not for sale in WY, DC



Item #	Desc	UPC	Vendor	CS/UOS	Location
80100006	2 pack	076807007009	124	48/12	East

Revenge® Fly Catchers

The original fly catching ribbon. Guaranteed not to dry out in the package or in use. EZ Grab tab makes deployment simple Odorless and for use indoors or in outbuildings.

Not for sale in WY, DC



Item #	Desc	UPC	Vendor	CS/UOS	Location
80100768	100 pack Shelf Display	37321461265	46126	100/100	East

Revenge® Jumbo Fly Catchers

8 feet of our UV stable, non-drying "memory glue" - won't adhere to skin. One sided coating for clean, EZ application to walls, ceilings, poles, even trees. A nice big 7.25" wide roll for maximum fly catching capacity.

Not for sale in WY, DC



Item #	Desc	UPC	Vendor	CS/UOS	Location
80100424	12 pk	076807000451	46220	12/12	East

FUNGICIDES

Infuse Systemic Disease Control Concentrate

Bonide Infuse Systemic Disease Control Concentrate prevents and controls over 30 plant diseases, including tough to control soil borne pathogens. The formula is ideal for use on bulb, annual and perennial flowers, bedding plants and ground covers, deciduous and evergreen trees and shrubs. **Not for sale in AR, HI, IN, KY, LA, MT, WI, DC**



Item #	Desc	UPC	Vendor	CS/UOS	Location
80100053	16 oz Con.	037321001485	148	12/12	West

Sulfur Dust

90% Sulfur. A specially prepared micronized sulfur suitable for use as a dust or spray. The fine particle size gives better coverage, adhesion and disease control. This product controls a large number of diseases on fruits, vegetables and various ornamentals. Approved for organic gardening. Now labeled for chiggers.

Not for sale in AK, DC



Item #	Desc	UPC	Vendor	CS/UOS	Location
80100156	1 lb.	037321001416	141	12/12	East
80101035	4lb	037321001423	1428	8/8	National

Mancozeb® Flowable with Zinc

Mancozeb with Zinc 37.0%. A broad spectrum fungicide for use on a wide variety of vegetables and ornamentals. Controls leaf spot, downy mildew, blights, anthracnose, botrytis and other listed diseases. Use 2-5 teaspoons per gallon.

Not for sale in AK, AZ, CA, CO, HI, ID, MT, ND, NM, NV, NY, OR, SD, UT, WA, WY



Item #	Desc	UPC	Vendor	CS/UOS	Location
80100620	16 oz. Con.	037321008620	862	12/12	East

Revitalize Bio

A high potency biofungicide/bactericide that controls many diseases and is suitable for organic gardening. Triggers plant immune response



Item #	Desc	UPC	Vendor	CS/UOS	Location
80100911	16 oz Con	037321007777	777	12/12	East
80100912	32 oz RTU	37321007791	779	12/12	National



Copper Fungicide

This patented, copper formulation protects a wide range of plants from turf to veggies, to fruit and flowers from a host of listed diseases. Great for Blight! Suitable for organic gardening. Dust or Spray - Copper Sulfate 7.0%. Liquid - Copper Octanoate.

1lb. Can Not for sale in AK, CA



Item #	Desc	UPC	Vendor	CS/UOS	Location
80100034	1 lb. Can	037321007715	771	12/12	National
80100611	4 lb. Bag	037321007722	772	12/12	East
80101078	16 oz Con.	037321008118	8116	6/6	East
80100929	16 oz RTS	037321008132	813	6/6	East
80100932	32 oz RTS	037321008149	814	6/6	East
80101075	32 oz RTU	037321007753	7756	6/6	National

Fung-onil®

Truly all purpose. Controls numerous diseases on roses, flowers and vegetables, fruit and shade trees. Contains Chlorothalonil, commonly known as Daconil. **Not for sale in AK, HI RTU: Not for sale in HI, KS**



Item #	Desc	UPC	Vendor	CS/UOS	Location
80100038	16 oz Con.	37321008804	880	12/12	National
80100198	32 oz Con	37321008811	881	12/12	East
80101088	32 oz RTU	037321008835	8836	6/6	National



Houseplant Insect Killer and Mite Control

Houseplant Insect & Mite Control kills and controls listed insects, mites and controls listed fungal diseases, all in just one product. The insect killer fights to kill and control Ants, Earwigs, Fruit Flies, Lace Bugs, Loopers and more.



Item #	Desc	UPC	Vendor	CS/UOS	Location
82270140	24 oz RTU	840216200036	800100B	8/8	National

Home Pest Control Plus Germ Killer

Ready to Use Home Pest Killer Plus Germ Killer. Kills insects and reduces 99% of the germs that they may leave behind.

Not for sale in CA, ME



Item #	Desc	UPC	Vendor	CS/UOS	Location
82270054	24 oz RTU	840216200104	800300A	12/12	National
82270055	1 gal RTU	840216200111	800301A	12/12	National

Home Pest Bed Bug & Flea Killer

Roach killer indoor, insect killer: kills bed bugs, ticks, fleas, crawling pests and other listed insects. Up to 30 days protection: kills bed bug eggs before they hatch and other listed insects for up to 30 days. **Neonic Not for Sale CT, ME, MD, NJ, NY, VT**



Item #	Desc	UPC	Vendor	CS/UOS	Location
82270081	15 oz	687073013207	701320A	12/12	National
82270007	15.7 oz Non-neonic	687073013283	701328A	12/12	National

Home Insect Killer

Keeps killing for up to 18 months. For American and German Cockroaches and Argentine Ants on non-porous surfaces. **Not for sale in CA, ME**



Item #	Desc	UPC	Vendor	CS/UOS	Location
82270014	1.3 gal RTU	840216200388	820038A	4/4	National

Vegetable & Garden Insect Spray

Kills over 70 listed insects including Aphids, Caterpillars, Thrips, Tomato Hornworm, and Whiteflies. Protect fruits and vegetables from insect damage, for outdoor use. Active ingredient 0.75% Cyfluthrin.



Item #	Desc	UPC	Vendor	CS/UOS	Location
82270072	32 oz Con.	687073015218	701521A	8/8	National



Tomato & Vegetable Insect Killer

Kills listed pests, such as aphids, adult Japanese beetles, cutworms. Leafy, fruiting and root vegetables such as tomatoes, peppers, carrots, as well as on cucurbits. Active ingredient Cyfluthrin.

Not for sale in CA



Item #	Desc	UPC	Vendor	CS/UOS	Location
82270073	24 oz RTU	687073075236	707523A	8/8	National
82270058	32 oz RTS	687073075229	707522A	8/8	National

Tomato, Vegetable & Fruit Insect Control

Kills on contact to protect your edibles against Aphids, Caterpillars, Mealybugs, Spider Mites and other listed pests. Use to protect edibles such as vegetables, fruit and nut trees, citrus, berries, herbs and outdoor container-grown plants.



Item #	Desc	UPC	Vendor	CS/UOS	Location
82270021	24 oz RTU	840216200470	820047B	8/8	National

3-in-1 Fruit & Vegetable Solution Concentrate

Protects your garden from a wide range of fungal diseases such as Black Spot, Powdery Mildew, Rust and more; For best results, apply early in the season before diseases are noticed



Item #	Desc	UPC	Vendor	CS/UOS	Location
82270175	32oz.	687073075007	707500E	4/4	National

Fruit, Citrus & Vegetable Insect Control

Perfect solution to prevent insects from destroying your plants. 32 oz., concentrate, Fruit, Citrus, and Vegetable Insect Control. This formula will provide you with season long protection. Kills insects instantly, and prevents new infestations from occurring. Specially formulated for edible plants. Formula is rainproof one hour after application. Active ingredient Imidacloprid. **Concentrate not for sale ME, MD, MA, NV, NJ, NY, RI, VT**



Item #	Desc	UPC	Vendor	CS/UOS	Location
82270071	32 oz Con.	687073015201	701520A	8/8	National

Rose & Flower Insect Killer

Ready to Use Dual Action Rose & Flower Insect Killer. Fast acting and lasts up to three times longer than competitive products - Based on product label comparisons. **Not for sale in CT, MD, VT and Nassau, Suffolk, Kings & Queens counties of NY, ME, MA, NJ**



Item #	Desc	UPC	Vendor	CS/UOS	Location
82270135	15oz Continuous Spray	687073013306	701330A	12/12	National
82270120	24 oz RTU Dual Action	687073025705	502570B	12/12	National
82270139	24 oz RTU	687073085709	708570A	12/12	National

All In One Rose & Flower Care

All-in-One Rose & Flower Care, Granules, 4lb., is convenient, easy-to-use and takes the guesswork out of application. Fertilizer, insect control and disease control in one application without spraying! Systemic formula cannot be washed off by rain.

***Imidacloprid version not for sale in CT, MD, VT, ME, MA, NJ, NY**



Item #	Desc	UPC	Vendor	CS/UOS	Location
82270123	4lb Granular (Imidacloprid)	687073011104	701110A	6/6	National
82270125	4lb Granular (Non-Neonic)	687073011166	701116E	6/6	National
82270009	32oz Conc	840216200616	708260D	8/8	National
82270129	32oz Conc (Imidacloprid)	687073012606	701260B	8/8	National
82270131	64oz Conc (Imidacloprid)	687073012620	701262B	4/4	National

2 In 1 Rose & Flower Care Granules

2-in-1 Systemic Rose & Flower Care feeds plus protects against listed insects in one easy step. Controls aphids, lace bugs, leafhoppers and thrips. Promotes strong roots and beautiful blooms. Rainproof protection lasts up to 6 weeks. ***Imidacloprid versions Not for sale in Nassau, Suffolk, Kings & Queens NY, CT, MD, VT, ME, MA, NJ**



Item #	Desc	UPC	Vendor	CS/UOS	Location
82270121	5lb Granular (Imidacloprid)	687073011005	701100A	6/6	National
82270127	10lb Granular (Imidacloprid)	687073012101	701210A	4/4	National



Disease Control For Roses Flowers & Shrubs

This concentrate will make up to 42 gallons of spray. Controls Black Spot, Powdery Mildew, Crabapple Scab, Rust, Boxwood Blight and other listed diseases. Best used to treat roses, flowers, trees, shrubs and even some houseplants. Systemic rainproof protection lasts up to 2 weeks! **Not for sale in NY**



Item #	Desc	UPC	Vendor	CS/UOS	Location
82270128	32oz Concentrate	687073012507	701250B	8/8	National

3-in-1 Insect Disease & Mite Control

Triple protection for flowering plants, trees and shrubs. Kills and controls insects. Cures and prevents fungal disease. Controls Spider Mites. Protects up to two times longer against twice as many pests versus other brands. Systemic rain proof protection lasts up to 30 days. Active ingredients imidacloprid, tau-fluvalinate and tebuconazole. **Not for sale in CT, ME, MA, NJ, NY, VT. Concentrate Not for Sale CA, HI**



Item #	Desc	UPC	Vendor	CS/UOS	Location
82270134	24oz RTU	687073012903	701290B	12/12	National
82270132	32oz Concentrate	687073012859	701285B	8/8	National
82270133	32oz RTS	687073012873	701287A	8/8	National
82270197	32oz Concentrate	840216200654	820065B	8/8	National
82270196	32oz RTS	840216200647	820064B	8/8	National

Brush Killer Plus Quart Concentrate

Brush Killer Plus Concentrate kills tough brush and viney weeds, roots and all. This formula kills Kudzu, Poison Ivy, Poison Oak and Blackberries-over 75 hard to kill plants in all. Active ingredients Triclopyr, triethylamine salt.



Item #	Desc	UPC	Vendor	CS/UOS	Location
82270066	24 oz RTU	687073046304	704630D	6/6	National
82270067	32 oz Concentrate	687073046403	704640B	8/8	National
82270068	32 oz RTS	687073046458	704645A	8/8	National
82270069	1 gal RTU	687073046557	704655A	4/4	National
82270070	1.3 gal RTU power spray	687073047011	704701A	4/4	National

Extended Control Brush Killer

Extended Control Brush Killer its name is the full year of control-365-days-against tough brush such as Poison Ivy, Poison Oak, Kudzu, Blackberry and other Listed brush. Our formula kills the root. You will enjoy 12-months of protection. This 32 oz. concentrate covers 4,000 sq. ft. and can also be used to kill Stumps. Get More From the Blue Bottle. **Not for sale CA**



Item #	Desc	UPC	Vendor	CS/UOS	Location
82270174	32oz.	825216200258	800600B	8/8	National
82270173	1.3gal	825216200272	800620A	4/4	National

Tree and Shrub Protect & Feed Granules

Tree and Shrub Protect and Feed Granules provides 12-month long-lasting systemic protection against damaging insects including adelgids, aphids, borers, Japanese beetles, leaf miners, scale and white flies plus feeds in a single application. It provides slow-release feeding and no spraying required. Having beautiful trees and shrubs has never been easier. Concentrate active ingredients Merit insecticide, Clothidinid and feeds with 2-1-1 Fertilizer. *NY* Versions contain active ingredient Merit insecticide and 2-1-1 fertilizer. **Not for sale in CT, ME, MD, MA, NJ, NY, VT**



Item #	Desc	UPC	Vendor	CS/UOS	Location
82270145	32oz Concentrate	687073018103	701810A	8/8	National
82270148	32oz Concentrate *NY	687073019018	701901A	8/8	National
82270143	4lb Granular *NY	687073017007	701700B	6/6	National
82270147	4lb Granular	687073019001	701900B	6/6	National
82270142	1gal Concentrate	687073016154	701615A	4/4	National

Shrub Care Protect & Feed Granules

Shrub Care Protect & Feed 4lb Granules provides 6-weeks of systemic protection against damaging listed insects, including Aphids, Cuban Laurel Thrips (Ficus), adult Japanese beetles**, Leafhoppers, Root Weevils and more. It controls listed diseases like Black Spot, Powdery Mildew, Rust and Southern Blight. 6-9-6 Fertilizer Active ingredients Acephate, Tebuconazole. **Not for sale in NY**



Item #	Desc	UPC	Vendor	CS/UOS	Location
82270151	4 lb	840216200029	801000A	6/6	National



Pest Insect Killer

Home Pest Insect Killer is a versatile insect killer for indoor and outdoor use. Kills ants, fleas, roaches, scorpions, spiders and other listed insects. Kills fleas for up to 12 months. Kills over 50 listed insects. Great for use on houseplants. **Not for sale in CT, MD Nassau, Suffolk, Kings, Queens counties NY, ME, MA, NJ VT**



Item #	Desc	UPC	Vendor	CS/UOS	Location
82270080	15 oz	687073013108	701310A	12/12	National

Carpenter Ant & Termite Killer Plus

Kills ants, termites, fleas, ticks, crickets, spiders, flies, and more. Even controls Carpenter bees. Pump style sprayer with adjustable nozzle. Use on lawns, landscapes foundations, decks, and around home structures.

Not for sale in NY



Item #	Desc	UPC	Vendor	CS/UOS	Location
82270156	1gal Concentrate	687073003154	700315A	4/4	National
82270157	1 gal RTU	687073003321	700332A	4/4	National
82270158	1.3 gal power spray	687073003352	700335A	4/4	National

Termite Killer Granules

Termite Killer Granules prevents listed nuisance pest from getting inside your home by creating a protective barrier that lasts for up to 30 days. Just sprinkle and water in. The exclusive formula kills and protects against such listed insects as termites, ants, centipedes and digger wasps.

Non-Neonic Not for sale in NY



Item #	Desc	UPC	Vendor	CS/UOS	Location
82270004	9 lb	687073003505	700350L	4/4	National
82270008	9 lb non-neonic	687073003703	700370A	4/4	National

Termite & Carpenter Bee Killer Plus Foam

Termite and Carpenter Bee Killer Plus Foam kills termites you see and those you don't see on contact. Its broad-spectrum foam expands to cover hard-to-reach areas both indoors and out. Can be used on lawns, landscapes, foundations, decks, patios, wood piles and wooden elements in basements, crawl spaces, attics, decks, fencing and other listed areas.

Not for sale in MD, VT, and NY counties Nassau, Suffolk, Kings, Queens), NJ



Item #	Desc	UPC	Vendor	CS/UOS	Location
82270159	18oz Foam	687073004205	700420A	12/12	National

Insect Disease & Mite Control

Kills listed insects, diseases, and mites. Controls Ants, Aphids, Mites, Spider Mites, Whiteflies, Fruit Flies, Ear Wigs, and many more. Fungicide controls Blackspot, Powdery Mildew, Rust, Scab, Leaf Spot, and more.



Item #	Desc	UPC	Vendor	CS/UOS	Location
82270002	28 oz RTS	687073061253	706125D	4/4	National
82270100	24 oz RTU	687073071009	707100D	4/4	National

Home Insecticidal Soap

Home Insecticidal Soap protects ornamental and edible plants from damaging insects such as aphids, mealybugs, mites, whiteflies, and more. For use on vegetables, flowers, fruit, and houseplants. Use indoors or outdoors. Active ingredients: potassium salt of fatty acids.



Item #	Desc	UPC	Vendor	CS/UOS	Location
82270095	24 oz RTU	687073062304	706230A	8/8	National
82270020	1 gal RTU	840216200425	820042A	4/4	National

Lawn Weed and Disease Control

Kills listed weeds including Dandelion, Common Chickweed, Clover, and more down to the root. See visible results in hours. Fungicide controls Rust, Dollar Spot, Lichens, and more.



Item #	Desc	UPC	Vendor	CS/UOS	Location
82270023	24 oz RTU	840216200494	820049B	8/8	National

Houseplant Insect Killer

Provides quick control of pests in minutes, including Aphids, Mealybugs, Scale Insects, Whiteflies, Spider Mites and more. Controls powdery mildew on houseplants, flowers, shrubs and trees. Use to protect houseplants indoors and outdoors, and it is safe to use on flowers and shade trees.



Item #	Desc	UPC	Vendor	CS/UOS	Location
82270022	24 oz RTU	840216200487	820048B	8/8	National



Neem Oil

Neem Oil is an easy to use option for listed pests and diseases. For use on roses, flowers, fruits and vegetables. Controls aphids, whiteflies and spider mites. Controls black spot, rust and powdery mildew. Can be used up to the day of harvest. For Organic gardening.



Item #	Desc	UPC	Vendor	CS/UOS	Location
82270096	24 oz Concentrate	687073062403	706240A	8/8	National
82270097	24 oz RTU	687073062502	706250A	8/8	National
82270019	1 gal RTU	840216200401	820040A	4/4	National

Rose & Flower Insect Disease & Mite Control RTU

Protect Your Favorite Flowers From Both Fungal Diseases And Pests Controls Insects, Diseases And Mites Including Spider Mites, Aphids, Caterpillars, Whiteflies, And Other Listed Pests For Use On Roses, Flowers, Ornamental Trees And Shrubs Ideal For Controlling Rose Diseases Prevents Leaf Loss Caused By Black Spot And Rust.



Item #	Desc	UPC	Vendor	CS/UOS	Location
82270094	24 oz RTU	687073062205	706220B	8/8	National



Yard & Garden Insect Killer

Final Stop® Yard & Garden Insect Killer Spray produces remarkable results, because all the ingredients are formulated to perform different tasks and functions synergistically. Our unique combination of natural ingredients works to kill immediately, yet controls insects for weeks with continued protection.



Item #	Desc	UPC	Vendor	CS/UOS	Location
81160165	24oz. Conc.	749688240284	1022	12/12	West
81160164	24oz. RTU	749688649223	8003	12/12	West
81160180	32oz. RTS	749688320283	8004	12/12	West



Pest Control Killer

Pest Control Killer Spray produces remarkable results because all the ingredients are formulated to perform different tasks and functions synergistically, in a controlled fashion. Our unique combination of natural ingredients works to kill immediately, yet controls insects for weeks with continued protection.

Item #	Desc	UPC	Vendor	CS/UOS	Location
81160159	24oz. RTU	749688649230	8000	12/12	West

Snail & Slug Killer

Snail & Slug Killer Spray produces remarkable results, because all the ingredients are formulated to perform different tasks and functions synergistically, in a controlled fashion. Our unique combination of natural ingredients works to kill immediately, yet controls snails and slugs for weeks with continued protection.

Item #	Desc	UPC	Vendor	CS/UOS	Location
81160161	24oz. RTU	749688649278	8001	12/12	West

Vegetable Garden Insect Killer

Vegetable Garden Insect Killer Spray produces remarkable results because all the ingredients are formulated to perform different tasks and functions synergistically. Our unique combination of natural ingredients works to kill immediately, yet controls insects for weeks with continued protection.

Item #	Desc	UPC	Vendor	CS/UOS	Location
81160005	24oz. RTU	749688649261	8005	12/12	West

Weed & Grass Herbicide

Weed & Grass Herbicide Killer Spray is a herbicide that produces remarkable results, because all the ingredients are formulated to perform different tasks and functions synergistically, in a controlled fashion. Our unique combination of natural ingredients works to kill immediately.

Item #	Desc	UPC	Vendor	CS/UOS	Location
81160163	24oz. RTU	749688649216	8002	12/12	West

Rose & Flower Insect Killer

Rose & Flower Insect Killer Spray produces remarkable results, because all the ingredients are formulated to perform different tasks and functions synergistically. Our unique combination of natural ingredients works to kill immediately, yet controls insects for weeks with continued protection.

Item #	Desc	UPC	Vendor	CS/UOS	Location
81160160	24oz. RTU	749688649247	8008	12/12	West



House Plant Insect Killer

House Plant Insect Killer Spray produces remarkable results, because all the ingredients are formulated to perform different tasks and functions synergistically. Our unique combination of natural ingredients works to kill immediately, yet controls insects for weeks with continued protection.



Item #	Desc	UPC	Vendor	CS/UOS	Location
81160136	12oz. RTU	749688079990	7999	6/6	West

Disease Control Fungicide

Disease Control Fungicide is a protective dormant spray that provides year-round disease control on trees, shrubs, lawns flowers and edibles. Our unique combination of natural ingredients kills and controls powdery mildew and other mold. Kills on contact while providing continued protection for weeks.



Item #	Desc	UPC	Vendor	CS/UOS	Location
81160157	24oz. RTU	749688649285	8007	12/12	West
81160177	32oz. RTS	749688320221	7004	12/12	West



Vole Scram™

Vole Scram is a new and unique natural repellent that drives out voles from your garden and lawn. Unlike other repellents, it works by taste and smell. It is easily applied and contains all organic ingredients. It won't harm people or animals and won't wash away with rain.



Item #	Desc	UPC	Vendor	CS/UOS	Location
80580027	6 lb.	186955000149	18006	6/6	National

Mole Scram™

Mole Scram™ contains more active ingredients and a stronger formula than other repellents, yet it's organic and environmentally safe. The triple action formula works by taste and smell, and also reduces the presence of moles' insect food. Mole Scram™ rids your yard of moles and keeps them from returning. **Not for sale in AK, ME, MT, NE, NV, NM, WY, DC**



Item #	Desc	UPC	Vendor	CS/UOS	Location
80580066	4.5 lb. Bag	186955000071	12040	6/6	National
80580011	10 lb Bag	186955000590	12010	4/4	National

Deer Scram™

All natural, biodegradable, environmentally safe and guaranteed to keep deer and rabbits away from your prized gardens, shrubs and trees, while not being offensive to humans. Deer Scram won't harm animals, the environment and, most importantly, you and your family. Blended from selected organic components, Deer Scram will keep deer off your plantings because it convinces deer that harm is nearby through their uncanny sense of smell.



Item #	Desc	UPC	Vendor	CS/UOS	Location
80580036	2 lb Bag	186955000040	1004	6/6	National
80580001	2.5 lb. Can	186955000033	1003	12/12	National
80580064	6lb. Bag	186955000026	10060	6/6	National
80580003	25 lb. Pail	186955000255	1025	1/1	National

All Natural Rabbit Scram™

Granular and easy to use, all natural and environmentally safe. Specifically formulated to stop rabbit damage to vegetables, shrubs and flowers, and it's guaranteed. It doesn't smell bad and won't wash off in rain. Rabbit Scram™ won't harm animals, the environment or you and your family.



Item #	Desc	UPC	Vendor	CS/UOS	Location
80580038	2 lb Bag	186955200446	11004	6/6	National
80580005	2.5 lb. Can	186955000439	11003	12/12	National
80580065	6 lb. Bag	186955000118	11060	6/6	National

Scram™ For Dogs Shaker Bag

Americas finest dog repellent works faster, is more effective and is less expensive per square foot. Provides strong, natural repelling power that trains dogs to stay away from these areas around your home without harming people, pets.



Item #	Desc	UPC	Vendor	CS/UOS	Location
80580019	3.5lb.	186955000743	14003	6/6	West

Scram™ For Cats Shaker Bag

Americas finest cat repellent works faster, is more effective and is less expensive per square foot than other cat repellents on the market. Provides strong, natural repelling power that trains dogs to stay away from these areas around your home without harming people, pets.



Item #	Desc	UPC	Vendor	CS/UOS	Location
80580021	3.5lb.	186955000842	15003	6/6	National

Deer & Rabbit Repellent

Dual action formula. Dries odorless and clear. Deer, family & pet friendly. Long lasting! Up to 8 weeks! Spray any time on new growth. For use on bushes, flowers, shrubs, trees. Designed to be used year round. 100% Satisfaction guaranteed.



Item #	Desc	UPC	Vendor	CS/UOS	Location
81030001	32 oz. RTU	855289007000	ADPR032	12/12	National
81030002	1 gal. RTU	855289007017	ADPR128	4/4	National
81030003	32 oz. Con.	855289007024	ADPC032	6/6	East
81030029	5 LB Granular	855289007154	ADPG5D	4/4	East
81030028	2 LB Granular	855289007147	ADPG2D	6/6	East
81030027	32oz Hose End	855289007123	ADPC32R	6/6	East

Tick & Mosquito Repellent

This product is environmentally friendly, has six key active ingredients and a spreader sticker for up to four weeks of efficacy without washing off. Safe to use around children & pets. Non-offensive odor. Use as a barrier repellent. Covers up to 10,000 sqft. (16oz covers up to 5,000 sqft.)



Item #	Desc	UPC	Vendor	CS/UOS	Location
81030015	32 oz. RTS	855289007079	ADPTM32R	6/6	National
81030016	32 oz. Con.	855289007086	ADPTM32C	6/6	East
81030019	16 oz. Con.	855289007109	ADPTM16R	6/6	National
81030030	2lb. Granular	855289007161	ADPG2T	6/6	East
81030031	5lb. Granular	855289007178	ADPG5T	4/4	East

Small Animal Repellent

Designed and used daily to repel mice, chipmunks, squirrels, skunks and other small mammals. Proven to be safe and extremely effective. Everguard Small Animal Repellent is a ready-to-use product. Simply shake bottle and spray your plants. Take back your yard and enjoy the beauty of flowering plants.



Item #	Desc	UPC	Vendor	CS/UOS	Location
81030007	32 oz. RTU	855289007055	ADPAR032	12/12	East
81030008	1 gal. RTU	855289007062	ADPAR128	4/4	East

MK-1 Marketing Kit



POP Marketing Kit

Item #	Desc	Vendor	CS/UOS	Location
81030034	Kit	POP	1/1	East

ferti·lome

Brush Killer Stump Killer

For the control of unwanted woody plants, vines and broadleaf weeds around homes, cabins, fences, walkways, and other non-crop areas. **Not for sale in AK, HI, DC**



Item #	Desc	UPC	Vendor	CS/UOS	Location
82280121	8 oz RTU	732221114838	11483	12/12	East
82280122	16oz Concentrate	732221114845	11484	12/12	East
82280123	32oz Concentrate	732221114852	11485	12/12	East

MoleGo Granules

Repels moles and other small animals from your lawn, garden and flower bed. For year-round control apply mole repellent in early spring, mid summer & early fall. The mole remover can be used when planting new plants, trees and shrubs. Covers 5000 sq ft. **Not for sale in AK, HI, MD, MT, NY, RI, WI, WY, DC.**



Item #	Desc	UPC	Vendor	CS/UOS	Location
82280117	10 lb	732221113176	11317	1/1	East

ferti·lome®

Yield Booster RTU

Helps stop blossom end rot on Tomatoes and setting of fruit and correcting calcium deficiencies. Contains 1.5% Calcium derived from Calcium Chloride. **Not for sale in HI**



Item #	Desc	UPC	Vendor	CS/UOS	Location
82280027	32oz RTU	732221106055	10605	12/12	East

Pruning Sealer Aerosol

A protective seal for pruning cuts. Spray ends of pruned branches and limbs thoroughly to provide a tough, rapid drying coating over pruned areas. Fast and easy to use aerosol spray can. Asphalt base.

Not for sale in AL, AK, AR



Item #	Desc	UPC	Vendor	CS/UOS	Location
82280001	15 oz	732221100152	10015	12/12	East

Tomato & Pepper Set RTU

Help blossoms set fruit, reduce end rot, and produce larger, meatier fruits. Active ingredient Cytokinin, as kinetin, based on biological activity. For use on Tomatoes, Beans, Cucumbers, Eggplants, Melons, Okra, Peppers, Strawberries, Grapes.

Not for sale in AK, CA, HI, WI



Item #	Desc	UPC	Vendor	CS/UOS	Location
82280002	32oz RTU	732221100275	10027	12/12	East

Start & Grow Premium Plant Food 19-6-12

A premium slow released fertilizer designed for use at planting time as well as for use as a maintenance fertilizer to help maintain professional looking plants and landscapes. **Not for sale in AK, DE, GA, HI, MD, MT, NV, VT, WA**



Item #	Desc	UPC	Vendor	CS/UOS	Location
82280128	4 lb.	732221117457	11745	12/12	East

Rooting Powder

Great for seeding or transplanting to stimulate early root formation and stronger root development. This root stimulator is easy to use. Simply dip the cutting into the powder before planting.

Not for sale in AK, HI



Item #	Desc	UPC	Vendor	CS/UOS	Location
82280037	2 oz	732221106390	10639	12/12	East

Triple Action

An effective insecticide, miticide and fungicide all in one provides plants with complete protection. Controls Aphids, Spider Mites, Scale, Mealybug, Whiteflies and more. Controls various Fungal diseases including Powdery Mildew Black Spot, Anthracnose, Rust, and many others listed. Contains Pyrethrins, and NEEM. OMRI listed. **Not for sale in AK, HI**



Item #	Desc	UPC	Vendor	CS/UOS	Location
82280142	8oz Concentrate	732221122444	12244	12/12	East
82280143	16oz Concentrate	732221122451	12245	12/12	East
82280144	32oz Concentrate	732221122468	12246	12/12	East
82280007	32 oz RTU	732221102514	10251	12/12	East
82280108	32 oz RTS	732221112476	11247	12/12	East

Tree & Shrub Drench

Control pests like Aphids, Leaf Beetles, Leafhoppers, Borers, Leafminers, Mealybugs, Japanese Beetles, Scale, Thrip and Whitefly. See label for complete list of pests controlled. Dissolves in water and moves down through soil, and is absorbed through the roots. Provides up to 12 months of systemic protection. Contains Imidacloprid. **Not for sale in AK, CA, CT, DE, HI, MD, MA, NV, NJ, NY, VT, DC**



Item #	Desc	UPC	Vendor	CS/UOS	Location
82280104	16oz Concentrate	732221112056	11205	12/12	East
82280105	32oz Concentrate	732221112063	11206	12/12	East
82280106	1gal Concentrate	732221112070	11207	4/4	East

Fruit Tree Spray

Kills Eggs, Larvae and Adult Insects. Prevents Fungal Attack of Plant Tissues. Use Indoors or Out. Can be used on fruits, nuts, vegetables, herbs, spices, roses, houseplants, flowers, shrubs and turfgrass. **Not for sale in AK, CA, HI**



Item #	Desc	UPC	Vendor	CS/UOS	Location
82280006	16oz Concentrate	732221101319	10131	12/12	East

Diatomaceous Earth

Diatomaceous Earth is a natural indoor and outdoor contact insecticide that works by causing abrasions on insects as they come in contact with product, resulting in loss of body fluids, then dehydration. Digestible by Earthworms, thus causing them no harm. Very effective in controlling Snails and Slugs in bedding plant areas and around houses. **Not for sale in AK, DC, HI, NY**



Item #	Desc	UPC	Vendor	CS/UOS	Location
82280390	4 lb.	732221402546	16004	4/4	East
82280391	7 oz.	732221402607	16005	12/12	East

Dipel Dust Biological Insecticide

Bacillus Thuringiensus Dipel Dust kills a number of crop destroying insects, such as Bagworms, Armyworms, Tent Caterpillar, and more. Can be used on vegetables, shrubs, lawns and flowers to kill insects biologically. **Not for sale in AK, CA, HI, MD, WI**



Item #	Desc	UPC	Vendor	CS/UOS	Location
82280026	1lb Puffer	732221105867	10586	12/12	East
82280070	4 lb	732221108592	10859	12/12	East

Premium Lawn & Garden Sprayer

Strong Metal Pump Rod. Broad Base for Increased Stability.



Item #	Desc	UPC	Vendor	CS/UOS	Location
82280092	1gal Sprayer	732221109728	10972	1/1	East

Come & Get It Products

For outdoor use around residential sites. Slug and bug control. Use around flowers, gardens, turf, and ornamentals. Lasts up to four weeks. **Not for sale in AL, AK, CA, FL, GA, HI, ME, MD, NY, ND, OK, SD**



Item #	Desc	UPC	Vendor	CS/UOS	Location
82280156	1 lb spinosaad plus	732221160255	16025	12/12	East
82280158	1 lb slug & snail bait	732221160354	16035	12/12	East
82280157	3 lb slug & snail bait	732221160347	16034	12/12	East

Fungicide

Use on vegetables, fruits, nuts, trees, shrubs, lawns, flowering plants, houseplants, and tropicals. Bacillus amyloliquefaciens strain D747. **Not for sale in AL, AK, CA, FL, GA, HI, ME, MD, ND, SD**



Item #	Desc	UPC	Vendor	CS/UOS	Location
82280172	16oz Concentrate	732221161122	16112	12/12	East
82280173	32 oz RTS	732221161146	16114	12/12	East
82280174	32 oz RTU	732221161160	16116	12/12	East

Chameleon® Adaptable Hose End Sprayer

Chameleon Adaptable Hose End Sprayer is a versatile hose end sprayer. It includes 3 different spray positions. A quick connect adapter easily attaches to hoses. The sprayer can adapt to fit multiple container sizes. Handle design helps minimize contact with chemicals for a safer application method.



Item #	Desc	UPC	Vendor	CS/UOS	Location
82280093	32 oz	732221109797	10979	6/6	East

Hi-Yield®

Measuring Cup

These 4 oz plastic cups are calibrated for Teaspoon, Tablespoon and Ounces to provide a handy reusable measuring device. Do not use for food products.



Item #	Desc	UPC	Vendor	CS/UOS	Location
82280094	1 cup	732221110083	11008	36/36	East

Hi-Yield®

Killzall 365

Control unwanted weeds for up to one year. Use on non-crop areas such as fencerows, driveways, around buildings for total vegetation control. 32oz concentrate treats up to 4,300 square feet. Contains 43% Glyphosate and 0.78% Imazapyr.

Not for sale in AK, HI, IA, NY, RI, DC



Item #	Desc	UPC	Vendor	CS/UOS	Location
82280251	32oz Concentrate	732221321700	32170	12/12	East
82280252	1gal Concentrate	732221321717	32171	4/4	East

Killzall Quick

Our fastest KILLZALL yet! Rainproof in 10 minutes, reaches roots in 1-2 hours; visible results in as little as 3 hours. A non-selective systemic weed and grass killer that will eliminate undesirable vegetation – roots and all – in and around lawns, driveways, parking areas, between stepping stones and bricks, flower beds, trees and shrubs. Special caution should be taken to avoid spraying desired vegetation. Contains Glyphosate 2% and Pelargonic Acid.

Not for sale in AK, CA, HI



Item #	Desc	UPC	Vendor	CS/UOS	Location
82280249	32oz RTU	732221321687	32168	12/12	East
82280250	1gal RTU	732221321694	32169	4/4	East

Killzall Concentrate Weed & Grass Killer

Super concentrate, Non-selective weed and grass killer contains a double surfactant formulation that dries on plants fast to start working quickly down to the root. Use near fences, on paths, patios, sidewalks, curbs, and driveways. Rainfast in 2 hours. **Not for sale in AK, HI, DC**



Item #	Desc	UPC	Vendor	CS/UOS	Location
82280307	16oz Concentrate	732221336919	33691	12/12	East
82280308	32oz Concentrate	732221336926	33692	12/12	East
82280309	1gal Concentrate	732221336933	33693	4/4	East

Killzall Extended Control

Kills and prevents listed weeds and grasses for up to 3 months. Apply only where no vegetation is desired; established grassy and broadleaf weeds and weed prone areas, where weeds have not yet emerged. Visible effects should occur in 3-5 days with complete kill in 2-4 weeks. Contains 2% Glyphosate and 0.5% Prodiamine. **Not for sale in AK, CA, HI, MA**



Item #	Desc	UPC	Vendor	CS/UOS	Location
82280311	32oz Concentrate	732221336988	33698	12/12	East

Spreader Sticker

A water soluble spray additive that makes water wetter and increases absorption, translocation and sticking of pesticides. Low foaming and contains no oil.

Not for sale in DC, HI, VT, WA



Item #	Desc	UPC	Vendor	CS/UOS	Location
82280199	8oz Concentrate	732221310612	31061	12/12	East
82280200	16oz Concentrate	732221310629	31062	12/12	East

55% Malathion Spray

Effectively controls aphids, thrips, spider mites, lace bugs and more. See label for full list. For use on herbaceous plants, ornamental non-flowering plants, shrubs, vegetables, and fruit trees. The active ingredient in this 16 oz. bottle of insecticide spray is 55% Malathion. **Not for sale in AK, CA, HI, MD, NY, DC**



Item #	Desc	UPC	Vendor	CS/UOS	Location
82280218	8oz Concentrate	732221320277	32027	12/12	East
82280219	16oz Concentrate	732221320284	32028	12/12	East

Kill-A-Bug II Indoor/Outdoor Spray

Long-lasting action continues killing insects for up to four months after you spray. Use in and around residences and their immediate surroundings. **Not for sale in AK, HI, ME, MD, MA, NJ**



Item #	Desc	UPC	Vendor	CS/UOS	Location
82280266	32 oz RTU	732221323100	32310	12/12	East
82280265	1 gal RTU	732221323087	32308	4/4	East

Hi-Yield®

Bug Blaster Bifenthrin 2.4 RTS

Treats Up To 5,300 Sq. Ft. Odor Free, Non Staining & Water Based Provides Up To 4 Months Control of Cockroaches & 3 Months Control of Other Pests Listed on Label. **Not for sale in AK, HI, MA, NE, NY, RI, DC**



Item #	Desc	UPC	Vendor	CS/UOS	Location
82280274	16oz Concentrate	732221323957	32395	12/12	East
82280264	32 oz RTU	732221322974	32297	12/12	East

Fire Ant Control with Acephate

A granule insecticide for control of fire ants. Contains the active ingredient Acephate. Designed for use on residential, recreational turfgrass, commercial turf as well as non-crop areas. This fire ant control solution controls fire ants for a full season for long lasting protection. **Not for sale in AK, CA, CO, CT, DE, HI, IL, IN, IA, KY, ME, MD, MA, MN, MO, MT, NE, NH, NJ, NY, ND, OH, OR, PA, RI, SD, UT, VT, WA, WV, WI, WY, DC**



Item #	Desc	UPC	Vendor	CS/UOS	Location
82280283	8oz	732221330337	33033	12/12	East
82280284	1lb	732221330351	33035	12/12	East

Stump Remover

This product decomposes the wood of tree stumps allowing for easy removal or burning. This tree stump remover is harmless to vegetation surrounding the stump.



Item #	Desc	UPC	Vendor	CS/UOS	Location
82280215	1.5 lb	732221320154	32015	12/12	East

Vegetable, Flower, Fruit & Ornamental Fungicide

Controls Take All Patch, Brown Patch, Dollar Spot, Leaf Spot and more. See label for full list. Prevents and cures fungal diseases on vegetables, flowers, fruit, ornamentals, trees and shrubs. Apply the fungicide early in the season. Most effective when applied at first sign of disease. **Not for sale in AK, CA, CO, HI, ID, MA, MT, RI, WY, DC**



Item #	Desc	UPC	Vendor	CS/UOS	Location
82280301	32oz	732221335509	33550	12/12	East

Root Killer

Use to clear out sewer lines, septic tanks and drain fields. Will not harm trees, shrubs, sewer or drain pipes. Formulated to quickly and economically kill and dissolve fungus and roots from trees and shrubs. **Not for sale in AK, CA, CT, HI, ME, NJ, NY, NC**



Item #	Desc	UPC	Vendor	CS/UOS	Location
82280300	1.5 lb	732221334816	33481	12/12	East

Triclopyr Ester

Controls actively growing annual and perennial broadleaf weeds such as Oxalis and Wild Violet. Can be used on perennial bluegrass, perennial ryegrass, and tall fescue ornamental turf. Do not apply to Bahiagrass, Bentgrass, bermudagrass, Centipedegrass, St. Augustine, or Zoysiagrass. **Not for sale in AK, AZ, HI**



Item #	Desc	UPC	Vendor	CS/UOS	Location
82280313	8oz	732221352612	35261	12/12	East

Systemic Insect Granules

Controls aphids, whiteflies, leafminers, lace bugs and more. See label for full list of insects. Ideal for roses, flowers, shrubs and containerized plants both indoor and outdoor. The insecticide granules provide protection against damaging insects for up to 2 months. **Not for sale in AK, CT, HI, MD, MA, NV, NJ, NY, RI, VT, DC**



Item #	Desc	UPC	Vendor	CS/UOS	Location
82280207	1 lb	732221321885	31228	12/12	East

Herbicide Granules

These easy-to-apply granules are for use in flowerbeds, vegetable gardens, around ornamental trees, shrubs, and flowers listed on the label. **Not for sale in AK, HI, NM**



Item #	Desc	UPC	Vendor	CS/UOS	Location
82280192	4 lb	732221227422	22742	6/6	East
82280191	15lb	732221217485	21748	1/1	East

Hi-Yield®

Turf & Ornamental Weed & Grass Stopper

Provides superior control of Crabgrass and many other annual grass and broadleaf weeds. See label. Intended for use on ornamental landscape areas, established lawns and ornamental turf. **Not for sale in AK, HI, MA**



Item #	Desc	UPC	Vendor	CS/UOS	Location
82280282	35 lb	732221330313	33031	1/1	East

Multi-Use Dust

Controls Ants, Boxelder Bugs, Cockroaches (including both resistant and non-resistant strains), Crickets, Fleas, Firebrats, Silverfish, Termites, Carpenter Ants and Carpenter Bees, Centipedes, Ground Beetles, Millipedes, Scorpions, Spiders, Sowbugs and others listed on label. **Not for sale in AK, CA, HI, MA, NV, NY, RI, WA, WI, DC**



Item #	Desc	UPC	Vendor	CS/UOS	Location
82280226	1 lb	732221320581	32058	12/12	East
82280227	4 lb	732221320598	32059	12/12	East

Dusting Wettable Sulfur

Controls diseases and insects including Thrips and Rust Mites. See label for full list. It can be used as a dust or by combining with water to create a wettable spray. This product is highly effective in the control of Chiggers in your yard or garden. **Not for sale in AK, HI, MA, NJ, ND, DC**

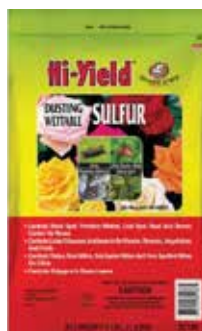

Item #	Desc	UPC	Vendor	CS/UOS	Location
82280257	4 lb	732221321885	32188	12/12	East

Vegetable & Ornamental Insect Control Granules

Designed as a ready-to-use granular insecticide to control various insects and spiders on home perimeter, ornamental & flower gardens. **Not for sale in AK, HI, MA, OK, WI**



Item #	Desc	UPC	Vendor	CS/UOS	Location
82280269	4 lb	732221323254	32325	12/12	East

Slug & Snail Bait

A very effective and easy to use Slug and Snail control. Formulated to attract Slugs and Snails, then paralyze them until the sun dehydrates them and they die. Longer lasting all weather formula effective up to 3 to 4 weeks. **Not for sale in AK, CA, HI, MA, NJ, NY**



Item #	Desc	UPC	Vendor	CS/UOS	Location
82280229	2.5 lb	732221320703	32070	12/12	East



Spinosad

Use on Vegetables, Fruits, Citrus, Lawn and Ornamentals. For Control Of Foliage Feeding Worms, Thrips And Other Listed Pests. Provides Control Of Spider Mites, Worms, Fire Ants And Thrips. **Not for sale in AK, FL, GA, HI, ME**



Item #	Desc	UPC	Vendor	CS/UOS	Location
82280161	16oz Concentrate	732221160521	16052	12/12	East
82280163	16 oz	732221160620	16062	12/12	East
82280162	32oz RTS	732221160552	16055	12/12	East
82280165	32 oz RTS	732221160644	16064	12/12	East
82280166	32 oz RTU	732221160767	16076	12/12	East

Caterpillar Killer Spray with BT

Non-toxic to humans, pets and beneficial insects. Use on Vegetables, Fruits, Ornamentals and Shade Trees to control leaf chewing worms like Tomato Hornworm, Gypsy Moth, Cabbage Looper, Tent Caterpillar, Imported Cabbage Worm, Bagworms and others list on label. **Not for sale in AK, GA, HI, ME**



Item #	Desc	UPC	Vendor	CS/UOS	Location
82280153	8oz Concentrate	732221160118	16011	12/12	East
82280154	16oz Concentrate	732221160125	16012	12/12	East
82280155	32 oz RTU	732221160163	16016	12/12	East



Diatomaceous Earth Crawling Insect Control

Control crawling pests like ants, earwigs, snails, and slugs naturally. Diatomaceous earth causes abrasions on pests as they come in contact which results in loss of body fluids. Digestible by Earthworms, thus causes no harm. **Not for sale in AK, CA, HI, TN, VA**



Item #	Desc	UPC	Vendor	CS/UOS	Location
82280152	7oz Puffer	732221160057	16005	12/12	East
82280151	4 lb	732221160040	16004	12/12	East

Horticultural Oil

Use as a dormant and growing season insect spray. Kills all stages of insects, including eggs. Use to control insects, mites, scale, for roses, flowers, fruits, vegetables, houseplants and trees. Use on Roses, Flowers, Fruits, Vegetables, Houseplants and Trees. **Not for sale in AK, GA, HI, ME, VA**



Item #	Desc	UPC	Vendor	CS/UOS	Location
82280159	16oz Concentrate	732221160422	16042	12/12	East

Copper Soap Fungicide

helps control powdery mildew, black spot, rust and more. Use on roses, fruits and vegetables, ornamentals and turf. Perfect for the organic gardener.

Not for sale in AL, AK, CA, FL, GA, HI, ME, MD, ND, SD



Item #	Desc	UPC	Vendor	CS/UOS	Location
82280177	16oz Concentrate	732221161320	16132	12/12	East
82280178	32 oz RTS	732221161344	16134	12/12	East
82280179	32 oz RTU	732221161368	16136	12/12	East

Neem

3 in 1 Multi-Purpose Fungicide, Insecticide, Miticide. For Organic Gardening use on Houseplants, Fruits, Flowers, Trees, Shrubs and other listed plants. Defend your plants and control diseases like Powdery Mildew, Black Spot, Downy Mildew, Anthracnose, Rust Leaf Spot, and others listed on label. Apply at the first sight of pests like Aphids, Spider Mites, Scale, Whiteflies, Beetles, and others listed. Can be used up to day of harvest. **Not for sale in AK, HI, ME**



Item #	Desc	UPC	Vendor	CS/UOS	Location
82280167	16oz Concentrate	732221160927	16092	12/12	East
82280168	32 oz RTU	732221160965	16096	12/12	East



SAFEHAVEN TRAPS

GONZO® Safe Haven™ live catch animal traps are constructed of heavy gauge, galvanized steel and set up in minutes. Keep unwanted animals from your grounds and humanely move them to a new location. No poisons or needless kills.



Small Animal Trap

The humane catch and release safe haven small animal trap. Great for Squirrels, Chipmunks, Feral Cats, Rabbits, and other small nuisance animals.

Item #	Desc	UPC	Vendor	CS/UOS	Location
82320051	Small Safehaven	855846004534	8000	10/10	National



Large Animal Trap

The humane catch and release safe haven Large animal trap. Great for Raccoons, Opossums, Skunks, Ground Hogs and other large nuisance animals.

Item #	Desc	UPC	Vendor	CS/UOS	Location
82320052	Large Safehaven	855846004541	8001	5/5	National

Safe Haven Large Trap with BONUS Small Trap



Item #	Desc	UPC	Vendor	CS/UOS	Location
82320053	BONUS Safehaven	855846004558	8002BP	3/3	National

Ground Squirrel Max Trap

The humane catch and release Safehaven Squirrel Max trap, traps multiple squirrels at once.



Item #	Desc	UPC	Vendor	CS/UOS	Location
82320054	Safehaven SquirrelMax	855846004565	8003	1/1	National

GONZO

Safe Haven Chipmunk Max Trap

Just bait and set along walls or known pathways. This versatile trap can be used anywhere, inside the house, barn, shed or outside. Keep unwanted animals from your grounds and humanely move them to a new location.



Item #	Desc	UPC	Vendor	CS/UOS	Location
82320060	Chipmunk Trap	855846004626	8005	5/5	National

Rodent Pro Mouse Trap

GONZO® ProSeries™ Multi-Max® Snap Traps are great for trapping mice or rats. This versatile trap can be used anywhere, inside the house, barn, shed or outside for rodents of all sizes. Patented 90° vertical trigger strikes faster than traditional traps and the unique design draws rodents deep into kill zone. 99% Success Rate...Kills the first time around!



Item #	Desc	UPC	Vendor	CS/UOS	Location
82320039	2 pk	855846004299	7000	12/12	National

Rodent Pro Sure-Strike Trap

GONZO® RodentPro® Superior® Sure-Strike® traps are a marked improvement from the traditional wood traps. Stainless steel mechanisms won't rust, keeping the trap dependable year after year. This versatile trap can be used anywhere, inside the house, barn, shed or outside. Super powerful springs ensure a quick, humane kill. Four-Way® mechanism kills mice and rats approaching the trap from any direction.



Item #	Desc	UPC	Vendor	CS/UOS	Location
82320057	2 pk Mouse	855846084596	7013	36/36	National
82320058	Single pk Rat	855846004602	7014	12/12	National

Rodent Pro Safe Haven Mouse Trap

GONZO® RodentPro® SafeHaven® live catch mouse traps and a cinch to use. Just bait and set along walls or known pathways. This versatile trap can be used anywhere, inside the house, barn, shed or outside. Humanely catch and release without ever having to touch the mice.



Item #	Desc	UPC	Vendor	CS/UOS	Location
82320046	2 pk	855846004428	7006	6/6	National

Rodent Safe Haven Trap

Just bait and set along walls or known pathways. This versatile trap can be used anywhere, inside the house, barn, shed or outside. Keep unwanted animals from your grounds and humanely move them to a new location.



Item #	Desc	UPC	Vendor	CS/UOS	Location
82320059	Rodent Trap	855846004619	8004	6/6	National

Safe Haven Rat Max Trap

Just bait and set along walls or known pathways. This versatile trap can be used anywhere, inside the house, barn, shed or outside. Keep unwanted animals from your grounds and humanely move them to a new location.



Item #	Desc	UPC	Vendor	CS/UOS	Location
82320061	Rat Max Trap	855846004633	8006	4/4	National

Mole Trap

Simply the best way to kill moles. Easy to place and set. All steel construction with powder coat finish provides long life.



Item #	Desc	UPC	Vendor	CS/UOS	Location
82320003	Mole Trap	855846004022	5002	6/6	West

Mole & Gopher Sonic Spike II Repellers

New and improved sonic spike repeller twin pack uses a microprocessor, eliminating analog parts that are prone to failure. Insert spikes close to your structure and gradually move spikes towards the perimeter of your yard.



Item #	Desc	UPC	Vendor	CS/UOS	Location
82320017	Sonic Repellers	855846004176	5016	6/6	West



Copper Stopper™ Slug & Snail Barrier Tape

Slugs and snails are deterred from crossing GONZO® Copper Stopper™ Barrier Tape as their slime secretions react with the copper surface providing them with an unpleasant sensation. Satisfaction Guaranteed!



Item #	Desc	UPC	Vendor	CS/UOS	Location
82320055	Slug & Snail Trap	855846004527	9000	12/12	West

Wire Gopher Trap

Kills Moles & Gophers effectively and safely without poisons. Features durable steel construction with powder coat finish for long-lasting use.



Item #	Desc	UPC	Vendor	CS/UOS	Location
82320001	2 pack	855846004008	5000	12/12	West
82320010	Bulk	855846004107	5000B	24/24	West

Dead-End® Mole & Gopher Trap

Your easy, no-mess way to stop moles & gophers dead in their tracks and keep them from destroying your lawn and property effectively and safely without poisons



Item #	Desc	UPC	Vendor	CS/UOS	Location
82320002	Dead-End Trap	855846004015	5001	12/12	West

Gopher Shield

Prevents moles, gophers and voles from destroying new plantings. Stainless steel weave creates long-lasting protection. Expands for new growth. Promotes healthy root growth year round.



Item #	Desc	UPC	Vendor	CS/UOS	Location
82320007	1 gal	855846004077	5007	6/6	West
82320008	5 gal	855846004084	5008	12/12	West
82320009	15 gal	855846004091	5009	6/6	West



Squirrel Stopper

Liquid products that stops indoor and outdoor foraging, nesting and entry damage caused by squirrels and chipmunks.



Item #	Desc	UPC	Vendor	CS/UOS	Location
81490087	Aerosol Sprayer	813935000218	SQ-U-SC1	12/12	National
81490088	32oz RTU	813935000065	SQ-U-016	6/6	National

Mole & Vole Stopper

Granular products that stop tunneling and foraging damage caused by moles, voles and shrews.

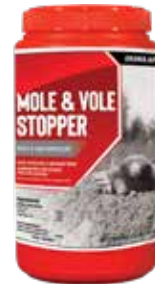

Item #	Desc	UPC	Vendor	CS/UOS	Location
81490073	2.5lb granular	813935000539	MV-G-001	4/4	National

Reptile Stopper

Granular products that stop entry, nesting and damage caused by snakes and reptiles.



Item #	Desc	UPC	Vendor	CS/UOS	Location
81490090	2.5lb granular	813935000560	SN-G-001	4/4	National

Animal Stopper Pet Safe Repellent

Animal Stopper can be used to deter deer, rabbits, groundhogs and most other common pests from low level foraging. 100% SATISFACTION GUARANTEED! It stops deer, rabbits, groundhogs, skunks and most common garden pests!



Item #	Desc	UPC	Vendor	CS/UOS	Location
81490045	32oz RTU	813935003004	AS-U-016	6/6	National
81490040	2.5lb granular	813935000119	AS-G-001	4/4	National
81490047	1gal w/Trigger Spray	813935003011	AS-U-128	4/4	National



Dog & Cat Stopper

Liquid and granular products that stop indoor and outdoor damage caused by most dog and cat breeds without causing pain or harm to them.



Item #	Desc	UPC	Vendor	CS/UOS	Location
81490098	2.5lb granular	813935000508	WW-G-001	4/4	National
81490095	32oz RTU	813935003028	WW-U-016	6/6	National

Deer Stopper

Ready-to-use and concentrate products that stop damage caused by deer, moose, elk and related animals. Available in two unique formulas, original Deer Stopper and Deer Stopper II, that may be used alone or rotated month to month as needed.



Item #	Desc	UPC	Vendor	CS/UOS	Location
81490058	1 quart	813935000256	DS-C-032	6/6	National
81490059	32oz RTS	813935000249	DS-C-032-HS	6/6	National
81490052	32oz RTU	813935000034	DS-U-016	6/6	National
81490062	DSII 32oz RTU	813935006661	XD-U-016	6/6	National
81490054	1gal w/ Trigger Spray	813935001116	DS-U-128	4/4	National

Rodent Stopper

Liquid products that stops indoor and outdoor foraging, nesting and entry damage caused by mice, rats and other rodents.



Item #	Desc	UPC	Vendor	CS/UOS	Location
81490080	Aerosol Sprayer	813935000201	RS-U-SC1	12/12	West
81490081	32oz RTU	813935004131	RS-U-016	6/6	National

Pulverize Weed & Grass Killer

Weed and Grass Killer is a fast acting, weed, grass, algae and moss killer. Incidental over spray will not stain concrete or pavement. Pulverize Weed and Grass Killer is a non-selective herbicide that controls many common annual weeds. Pulverize Weed and Grass Killer suppresses the growth of some bi-annuals and perennial weeds. It can be used in cultivated areas prior to planting grass or flowers. Best results are obtained with young, actively growing weeds, less than five inches in size.



Item #	Desc	UPC	Vendor	CS/UOS	Location
81490159	32oz Weed & Grass Killer RTU	813935009525	PWG-U-032	6/6	National



Ant, Roach & Spider Spray

Household insecticide with quick knockdown plus extended residual control. Kills roaches, ants, fleas, ticks, spiders, earwigs, silverfish and many more. For residual indoor and outdoor use. **Not for sale in AK, AR, AZ, DC, DE, GA, HI, IA, ID, IL, IN, KS, KY, LA, MD, ME, MN, MS, MT, ND, NE, NH, NV, NY, OR, RI, SC, TN, UT, VA, VT, WI, WV, WY**



Item #	Desc	UPC	Vendor	CS/UOS	Location
80820363	32 oz. RTU	022179105089	LG 6162	12/12	West

Once A Year Insect Control II

Used as a soil drench on ornamental trees, shrubs and certain fruit and nut trees. Controls adelgids, leaf beetles, leafhoppers, mealy bugs, scale, whiteflies, borers (including the Emerald Ash borer) and many others. No spraying, just use around the roots as a soil drench for full season insect control.



Not for sale in CT, MA, ME, MD, ND, DC, VT

Item #	Desc	UPC	Vendor	CS/UOS	Location
80820282	1 qt. Conc.	022179102620	LG 6342	6/6	West
80820081	1gal Conc.	022179102637	LG 6350	4/4	West

Mosquito Control

Kills mosquitos that may transmit West Nile Virus. Controls outdoor pests for up to 6 weeks. Use on lawns, trees, shrubs, roses, ornamentals, and around house foundations. **Not for sale in AL, AK, AZ, AR, CT, DE, FL, GA, HI, ID, IA, KS, LA, ME, MI, MN, MS, MO, MT, NE, NV, NM, ND, OK, OR, SC, SD, TN, TX, UT, WV, WI, WY**



Item #	Desc	UPC	Vendor	CS/UOS	Location
80820364	32oz RTS	022179105225	LG 6264	6/6	National
80820383	32oz RTU	022179105515	LG 6312	12/12	West
80820280	1 qt. Conc.	022179105133	LG 6279	6/6	West

Mite & Insect Control

Repels and eliminates mites, aphids, caterpillars, chinch bugs, fleas, mole crickets, ticks, whiteflies and many other listed pests. For use on lawns, trees, shrubs, roses, and ornamentals. Can be used around house foundations to kill and repel roaches, ants and more. **Not for sale in AK, FL, ID, KS, KY, ME, MD, MN, MT, NH, NM, NY, ND, WV, WY, DC**



Item #	Desc	UPC	Vendor	CS/UOS	Location
80820277	1 pt. Conc.	022179105096	LG 6172	6/6	National
80820278	1 qt. Conc.	022179105102	LG 6228	6/6	National



Sluggo®

Snail and slug control at its best. An alternative to traditional slug and snail baits, Sluggo contains iron phosphate and can be used around pets and wildlife. This product is labeled for use in vegetable gardens up until harvest and remains effective after rain or sprinkling. A pellet that breaks down into fertilizer! New lower rate, 1 lb. covers up to 2,000 sq ft.



Item #	Desc	UPC	Vendor	CS/UOS	Location
80820094	1 lb. Shaker	022179101241	LG 6515	12/12	National
80820095	2.5 lb. Jug	022179101852	LG 6500	6/6	National
80820372	2.5 lb. Display	022179101852	LG 10032	80/80	West
80820096	5 lb. Jug	022179101579	LG 6530	6/6	National
80820097	10 lb. bag	022179101203	LG 6510	1/1	National
80820098	10 lb. Jug	022179101869	LG 6555	6/6	West

Sluggo® Plus

This new formulation of Sluggo controls slugs, snails, earwigs, sow bugs (roly poly), pill bugs and cut worms too. Sluggo Plus is a smaller light green pellet and can be used on ornamentals, vegetables, fruit trees, berries, turf and in non-commercial greenhouses. Scatter the bait at ½ to 1 lb. per 1,000 sq ft around and near the plants to be protected. Contains the active Spinosad and iron phosphate.



Item #	Desc	UPC	Vendor	CS/UOS	Location
80820101	1 lb. Shaker	022179102484	LG 6575	12/12	National
80820102	2.5 lb Jug	022179102460	LG 6570	6/6	National
80820373	2.5 lb. Display	022179102460	LG 10081	80/80	West
80820103	5 lb. Jug	022179102583	LG 6580	6/6	West
80820104	10 lb. Jug	022179102590	LG 6585	6/6	West

Sluggo® Maxx

Controls snails and slugs and can be used around pets and wildlife. This product contains a higher concentration of iron phosphate than Sluggo® or Sluggo® Plus. 3x more power in each pellet! 1 lb. covers 11,000 sq. ft.

Not for sale in DE, FL, MI, ND, OH, OK, SC, TN, WY



Item #	Desc	UPC	Vendor	CS/UOS	Location
80820352	1lb Can	022179105201	LG 6542	6/6	National
80820353	2.5 lb Jug	022179105195	LG 6544	6/6	West

All Natural Snail & Slug Spray

Made from 100% naturally occurring plant materials. Repels snails and slugs on fruits, vegetables, citrus, and ornamentals. Excellent choice for preventative control! Can be used up to the day of harvest. **Not for sale in AK, AL, AR, CO, CT, DC, GA, IA, ID, IN, KS, KY, LA, MD, ME, MI, MO, MS, MT, NC, ND, NM NV, SC, SD, TN, UT, VA, VT, WV, WY**



Item #	Desc	UPC	Vendor	CS/UOS	Location
80820093	1 qt RTU	022179102903	LG 6440	12/12	National

All Natural Mite & Insect Control

Made from 100% naturally occurring materials. Controls mites and insects on vegetables, grapes, fruit and nut trees, and ornamentals. Provides broad spectrum control, rapid knockdown, and residual control. Can be applied to crops any time during the growing season up to the day of harvest. **Not for sale in AK, AL, AR, AZ, CO, CT, DC, GA, IA, ID, IN, KS, KY, LA, MD, ME, MI, MO, MS, MT, ND, NH, NM, NV, OH, OK, PA, RI, SC, SD, TN, VA, VT, WA, WI, WV, WY**



Item #	Desc	UPC	Vendor	CS/UOS	Location
80820055	1qt RTU	022179102781	LG 6284	12/12	National

Garden Insect Spray

For control of foliage feeding worms (caterpillars), thrips, fire ants and other listed pests in: Lawns, Outdoor Ornamentals, Vegetables, Apples, Citrus and Stone Fruit. Contains the active Spinosad.



Item #	Desc	UPC	Vendor	CS/UOS	Location
80820224	8 oz. Conc.	022179104730	LG 6158	12/12	West
80820070	16 oz. Conc.	022179101630	LG 6150	12/12	National
80820073	16 oz. RTS	022179102439	LG 6130	12/12	National
80820071	32 oz. Conc.	022179102446	LG 6135	12/12	National
80820223	32 oz. RTU	022179104341	LG 6133	12/12	National
80820074	32 oz. RTS	022179102958	LG 6138	12/12	West
80820072	1 gal. Conc.	022179102392	LG 6155	4/4	West

Insecticidal Soap RTU

Contains specially selected soaps (fatty acid salts) chosen for effective pest control. This product provides curative control of powdery mildew. **Not for sale in AK, AZ, AR, DE, GA, HI, ID, IL, IN, IA, KS, KY, LA, ME, MD, MN, MS, MO, MT, NE, NV, NH, NY, ND, OR, RI, SC, TN, UT, VT, VA, WV, WI, WY, DC**



Item #	Desc	UPC	Vendor	CS/UOS	Location
80820390	32 oz. RTU	022179105485	LG 6412	12/12	West



Monterey B.t.

Kills caterpillar-type insects, but has no effect on birds, earthworms, or beneficial insects such as honeybees and ladybugs, when used as directed. Worm stage and caterpillars eat treated foliage, then immediately stop feeding and damaging plants. For use on fruits, vegetables, ornamentals and shade trees. Can be used on edible plants up to the day of harvest. Contains BT Kurstaki bacteria. **RTU Not for sale in AR, ND, WY**



Item #	Desc	UPC	Vendor	CS/UOS	Location
80820225	8oz Conc.	022179104747	LG 6328	12/12	National
80820066	16oz Conc.	022179103900	LG 6332	12/12	National
80820069	32oz RTU	022179104082	LG 6338	12/12	National
80820196	32oz RTS	022179104297	LG 6334	12/12	National
80820067	1 qt. Conc.	022179103917	LG 6336	12/12	West
80820068	1 gal. Conc.	022179104068	LG 6344	4/4	West

Take Down Garden Spray

Will kill exposed aphids, beetles (colorado potato beetle, flea beetle, japanese beetle, asparagus beetle), caterpillars (gypsy moth caterpillars, tent caterpillar, diamondback moth larvae, leafrollers), ants (except fire ants, harvester ants, carpenter ants, and pharaoh ants), mealybugs, mites, leafhoppers, scale, thrips, fungus gnats, whitefly, adelgids, plant bugs, sawfly larvae, psyllids, spittlebugs, and phylloxera. Dormant and growing season insect spray that kills all accessible stages of listed insects, including eggs. Does not persist in the environment. Contains: Pyrethrins and Canola Oil. **Not for sale in ND, WY, DC**



Item #	Desc	UPC	Vendor	CS/UOS	Location
80820091	32 oz. RTU	022179103634	LG 6232	12/12	National
80820317	1pt. Conc.	022179101302	LG 6239	6/6	National
80820286	1 gal. Conc.	022179104419	LG 6247	4/4	West

Take Down -O

Item #	Desc	UPC	Vendor	CS/UOS	Location
80820388	1 pt. Take Down-O	022179105553	LG 6244	6/6	West
80820389	1 gal. Take Down-O	022179105560	LG 6249	4/4	West

Sucker-Stopper® RTU

This ready to use formula stops suckers on apples, pears, olives, and many woody ornamentals. Just spray on base of plant to control regrowth of suckers from roots and pruning wounds.



Item #	Desc	UPC	Vendor	CS/UOS	Location
80820110	16 oz. RTU	022179103924	LG 4300	6/6	National

Bug Buster II

Bug Buster II is specially formulated for homeowner use to control over 100 garden and nuisance pests in lawns, ornamentals, vegetables, flowers, fruits, and roses. Kills Japanese beetles, cicadas, fleas, ticks, ants, and tomato hornworms. Contains the proven active ingredient, Esfenvalerate. **Not for sale in AK, HI, NE, ND, WY, DC**



Item #	Desc	UPC	Vendor	CS/UOS	Location
80820226	8oz Conc.	022179104723	LG 6378	12/12	National
80820271	1 pt. Conc.	022179103313	LG 6382	6/6	West

Fungi-Max Multi Purpose Fungicide

Prevents controls all major plant diseases including anthracnose brown patch copper spot dollar spot leaf spot. Including septoria zonate melting out crown rot leaf smuts powdery mildew rust red thread spring dead spot necrotic ring spot summer patch others. Use outdoors on roses flowers ornamentals shrubs trees lawns fruit nut trees. ornamentals & bedding plants. **Not for sale in ND, WV, DC**



Item #	Desc	UPC	Vendor	CS/UOS	Location
80820210	8oz. Conc.	022179104631	LG 3213	6/6	West
80820211	1 pt Conc.	022179104648	LG 3216	6/6	West

Bug Buster-O Insect Control

This organic insecticide controls over 100 insects. A natural pyrethrin, it quickly knocks down and kills Cucumber Beetles, Japanese Beetles, Stink Bugs, Tomato Hornworms and many more insects. It can be used on fruits, vegetables and ornamentals - even on the day of harvest. Easy-to-use. **Not for sale in AZ, AR, ID, IA, KY, NE, NV, ND, WV, WY**



Item #	Desc	UPC	Vendor	CS/UOS	Location
80820191	8oz. Conc.	022179104211	LG 6398	6/6	National
80820192	1pt. Conc.	022179104228	LG 6396	6/6	West

Nematode Control

Nematode Control for home vegetable gardens, lawns, vineyards, fruit trees and ornamentals. It can be used up to the day of harvest. OMRI listed. Nematode Control Concentrate contains a natural ingredient that comes from the bark of a South American tree called Quilloja. Can be used as a pre-planting treatment or on established plants including berries, leafy greens, tomatoes, bulb, root and tuber vegetables, cole crops. **Not for sale in AK, DE, ID, IL, KS, ME, MA, MI, MN, NE, NV, NH, NJ, NY, ND, OH, SD, UT, VT, WV, WY, DC**



Item #	Desc	UPC	Vendor	CS/UOS	Location
80820129	1 qt.	022179103955	LG 6356	6/6	West



DIY Multi Insect Killer

This product is a perfect option for controlling adelgids, aphids, chafers, thrips, elm leaf beetles, leafhoppers, leaf miners, Japanese beetles, mealy bugs, whiteflies and many more. DIY Multi-Insect Killer is specifically designed for insect control for landscape ornamentals, residential trees and interior plantscapes. It is not designed for treating any food-bearing plants. **Not for sale in AL, AK, AR, CT, DE, FL, GA, HI, IN, KY, LA, ME, MA, MS, MT, NH, NJ, NY, NC, ND, RI, TN, VT, WV, WY, DC**



Item #	Desc	UPC	Vendor	CS/UOS	Location
80820059	15 ml	654702001218	LG 6220	12/12	West

Horticultural Oil

This pest control is great for use on aphids, leaf miners, thrips, leafhoppers, spider mites, scales, whiteflies, mealy bugs and many more. It gives poor control for caterpillar & worms. However, it does control eggs of all insects. Our insecticide is for use on a variety of trees & plants including apples, almonds, avocados, citrus, peaches, pecans, blackberries, figs, pineapple and more. **RTU Not for sale in AR, DE, ID, IN, NE, NH, OK, WV, WY, DC**



Item #	Desc	UPC	Vendor	CS/UOS	Location
80820275	1pt. Conc.	022179103740	LG 6286	6/6	West
80820077	32oz. RTS	022179103771	LG 6294	12/12	West
80820243	32oz. RTU	022179104907	LG 6302	12/12	West
80820276	1qt. Conc.	022179103757	LG 6299	6/6	West
80820078	1 gal. Conc.	022179103764	LG 6292	4/4	West

70% Neem Oil

A Fungicide/Insecticide/Miticide that helps control black spot, powdery mildew, rust, needle rust, downy mildew, spider mites, aphids, whiteflies, twig and tip blight, anthracnose, scab and flower, botrytis, alternaria, and other insect pests. **Not for sale in OR. RTU not for sale ND**



Item #	Desc	UPC	Vendor	CS/UOS	Location
80820222	8oz Concentrate	022179104716	LG6128	12/12	National
80820053	16 oz. RTS	022179102668	LG 6145	12/12	National
80820079	32 oz. RTU	022179103276	LG 6148	12/12	National
80820281	1 Pt. Conc.	022179101678	LG 6127	6/6	National
80820190	1 gal Conc.	022179104174	LG 6142	4/4	West

Liqui-Cop®

Liquid copper fungicide spray for disease prevention on fruit trees, nut crops, citrus, vegetables and ornamentals. Very economical replacement for Bordeaux mixture with an expanded label. Liqui-Cop is extremely waterproof and does not require oil or a sticker. A replacement for lime sulfur. Can be mixed with oils such as Monterey Horticultural Oil, for use as a dormant spray on fruit trees. **Not for sale in ND**



Item #	Desc	UPC	Vendor	CS/UOS	Location
80820229	8oz. Conc.	022179104754	LG 3102	12/12	West
80820049	32 oz. RTS	022179102576	LG 3190	12/12	National
80820296	1pt Conc.	022179100114	LG 3104	6/6	West
80820365	1qt Conc.	022179100121	LG 3109	6/6	West
80820048	1gal Conc.	022179103306	LG 3117	4/4	West

Fruit Tree Spray

Fruit Tree Spray Plus is a broad spectrum insecticide, fungicide and miticide for home garden use. This highly effective organic spray utilizes pyrethrins plus neem oil for fast and thorough action against a long list of targeted pests and diseases. Monterey Fruit Tree Spray Plus will act as an "exciter" to flush pests out of their hiding places and into direct contact with the spray. **Not for sale in AK, NE, ND, WY**



Item #	Desc	UPC	Vendor	CS/UOS	Location
80820273	1 pt. Con	022179104013	LG 6182	6/6	West
80820063	1 pt. RTS	022179104006	LG 6186	12/12	West

Foli-Cal®

This is a liquid calcium formulation based on 10% calcium acetate. Foli-Cal® will correct calcium-deficiency disorders such as blossom end-rot on tomatoes, peppers, eggplant and bitter-pit in apples. Foli-Cal® works on vegetables, tree and vine crops as well. **Not for sale in KY, ND, WY**



Item #	Desc	UPC	Vendor	CS/UOS	Location
80820308	1pt. Conc.	022179100817	LG 7204	6/6	West

Fish & Guano®

This organic concentrated fertilizer is made of liquid fish and bird guano. This is a high Analysis 9-6-2 natural fertilizer that can be applied monthly during the growing season. Whether at home or on a farm, this liquid fertilizer is excellent for your flowers, trees, transplants, and vegetables. Great for use on indoor houseplants. **Not for sale in ND**



Item #	Desc	UPC	Vendor	CS/UOS	Location
80820227	1qt. Conc.	022179103894	LG 7265	12/12	West



Complete Disease Control

Unique B.T. formula controls powdery mildew, Downy mildew, botrytis, Fusarium, fire blight, and many more hard to control diseases. Bee friendly. New biofungicide and bactericide that can be used as a foliar spray or soil drench.

Not for sale in ND



Item #	Desc	UPC	Vendor	CS/UOS	Location
80820220	8 oz. Concentrate	022179104433	LG 3370	6/6	National
80820221	16 oz. Concentrate	022179104440	LG 3374	6/6	National
80820209	32 oz. RTU	022179104488	LG 3174	12/12	National
80820298	32 oz. RTS	022179105171	LG 3176	6/6	West
80820297	1 gal Conc.	022179104471	LG 3382	4/4	West

Liquid Copper Fungicide RTU

For controlling diseases on vegetables, ornamentals, fruit, and algae in turfgrass. Dormant and growing season fungicide for control of listed plant diseases such as powdery mildew, rust, black spot, leaf and fruit spot, Downey mildew, late blights and leaf curl.

Not for sale in AR, ND, SC, WV, WY, DC



Item #	Desc	UPC	Vendor	CS/UOS	Location
80820230	32 oz. RTU	022179104617	LG 3154	12/12	National

Tomato Blossom Spray

This ready to spray fertilizer/herbicide can be used on tomatoes, cucumbers, squash, peppers, eggplant, melons, pumpkins, okra, strawberries, and other blooming crops. This spray increases the number of blossom sets and promotes flower growth for larger plant yields.

Not for sale in WA



Item #	Desc	UPC	Vendor	CS/UOS	Location
80820355	16oz. RTU	022179103986	LG 7234	6/6	West

Epsom Salts

Promotes bloom in roses and other flowering plants. Absorbed through the roots and foliage of plant. Epsom salts are a source of Magnesium that is essential to plant development. It is required by plants to produce chlorophyll. It also helps plants absorb Phosphorus. Promotes blooms in roses and other flowering plants.

Not for sale in ND



Item #	Desc	UPC	Vendor	CS/UOS	Location
80820143	4 lb.	022179100848	LG 7220	6/6	National

Remuda Weed & Grass Killer

Remuda Full Strength is a non-selective herbicide, it kills both annual and perennial grass, like crabgrass and many broadleaf weeds in lawns like thistle, clover, creeping charlie and poison ivy. This is post emergent herbicide is a 41% glyphosate concentrate with surfactant. Glyphosate is the worlds most commonly used herbicide. **Not for sale in AK, CO, FL, IL, IN, KS, KY, LA, ME, MD, MA, MN, MS, MO, NE, NV, NH, NM, NC, ND, PA, RI, SC, SD, TN, TX, VT, VA, WV, WI, WY, DC**



Item #	Desc	UPC	Vendor	CS/UOS	Location
80820015	1pt Conc.	022179101586	LG 5180	12/12	West
80820016	1qt Conc.	022179101593	LG 5185	12/12	West
80820017	1 gal Conc.	022179101609	LG 5190	4/4	West
80820018	2.5 gal Conc.	022179101616	LG 5195	2/2	West

Crab-E-Rad® Plus

For control of selective broadleaf weeds and certain grassy weeds in residential and ornamental turfgrasses. Use to control crabgrass, dandelion, clover, henbit, plantains, wild onion and many other listed lawn weeds.

Not for sale in AK, AR, CT, DR, FL, HI, ID, LA, MD, ME, MT, NY, RI, SD, VT, WY



Item #	Desc	UPC	Vendor	CS/UOS	Location
80820258	8oz Conc.	022179105003	LG 5208	6/6	West
80820259	1pt Conc.	022179105010	LG 5212	6/6	West

Vegetable & Ornamental Weeder

Promotes bloom in roses and other flowering plants. Absorbed through the roots and foliage of plant. Epsom salts is a source of Magnesium that is essential to plant development. It is required by plants to produce chlorophyll. It also helps plants absorb Phosphorus. Promotes blooms in roses and other flowering plants. **Not for sale in WA, DC**



Item #	Desc	UPC	Vendor	CS/UOS	Location
80820266	1 pt Conc.	022179101098	LG 5146	6/6	West
80820267	1qt. Conc.	022179101104	LG 5149	6/6	West

Fruit Tree & Vegetable Systemic Soil Drench

This pest control is great for use on aphids, flea beetles, leafhoppers, trips, whiteflies, Japanese beetles, mealy bugs and many more. Our soil drench is designed for use on tree & nut crops including Bananas, citrus, grapes, berries, pome fruits, stone fruits, cashews, pistachios, chestnuts, walnuts, avocados, Mangos and many more. **Not for sale in CT, DE, ME, MD, MA, NE, NH, RI, VT, WY, DC**



Item #	Desc	UPC	Vendor	CS/UOS	Location
80820361	1qt. Conc.	022179103788	LG 6274	6/6	West
80820061	1 gal. Conc.	022179103795	LG 6278	4/4	West



Star Thistle Killer

Use to control susceptible broadleaf weeds on established forage grasses in permanent ranchette grass pastures. **Available in CA Only**

Item #	Desc	UPC	Vendor	CS/UOS	Location
80820188	8oz. Conc.	022179103221	LG 5468	6/6	West

Thistledown

For selective control of broadleaf weeds in rangeland and permanent grass pastures. This concentrated herbicide will treat 1/2 - 2/3 acre. Controls Canada thistle, musk thistle, yellow star thistle, knapweed and more in home pastures and non-crop areas with no grazing restrictions. **Not for sale in CA, HI, NV, NH, NY, OR, RI, WY, DC**

Item #	Desc	UPC	Vendor	CS/UOS	Location
80820020	1 pt. Conc.	022179103269	LG 5482	6/6	West

Turflon Ester Specialty Herbicide

Turflon Ester controls bermudagrass, kikuyugrass and certain broadleaf weeds such as oxalis, ground ivy, wild violet, clover and ragweed. Consider these nuisances as good as gone. Our spray is used for the control of actively growing plants. Only emerged weeds present at the time of application will be controlled. **Not for sale in AK, ME, MA, MN, NH, ND, SD, DC**

Item #	Desc	UPC	Vendor	CS/UOS	Location
80820021	8oz. Conc.	022179101067	LG 5512	6/6	West
80820022	1 pt. Conc.	022179101050	LG 5518	6/6	West

Spurge Power®

Spurge Power 8 Oz is broadleaf herbicide for residential lawns. Controls dandelions, chickweeds, clover, oxalis, spurge, wild violet and many other broadleaf weeds.

Item #	Desc	UPC	Vendor	CS/UOS	Location
80820262	8oz. Conc.	022179104815	LG 5592	6/6	West
80820263	1 pt. Conc.	022179101159	LG 5599	6/6	West

Brush & Vine Control

Controls woody plants and vines in residential areas. Use to kill stumps and prevent regrowth of unwanted trees and shrubs. Controls vines such as Poison Oak and Poison Ivy. **Not for sale in DE, ID, IA, ME, MN, NH, NY, ND, RI, SD, WV, WY, DC**

Item #	Desc	UPC	Vendor	CS/UOS	Location
80820261	1qt Conc.	022179103931	LG 5367	6/6	West

Grass Getter

Grass Getter controls grassy weeds in bedding plants, ornamentals, ground covers, shrubs, and vegetables. This systemic herbicide kills most Annual and hard-to-kill Perennial grasses, as well as hard to control species such as Crabgrass, Bermudagrass, Foxtail, Goosegrass, Johnsongrass, Quackgrass and other listed grassy weeds. It will not control nutsedge (nutgrass), annual bluegrass (poa annua) or broadleaf weeds. **Not for sale in ME, NY, ND, DC**

Item #	Desc	UPC	Vendor	CS/UOS	Location
80820005	8oz. Conc.	022179100961	LG 5328	6/6	West

Weed Whacker

Including dandelions; oxalis; poison oak; spurge; rush; clover; aster and thistle. Consider these hard-to-control weeds as good as gone. Our 3-way herbicide is designed for warm & cool season turf. It's safe to use on Bluegrass; Fescue; Rye; St. Augustine; Bahia; Common Bermuda; Centipede; Zoysia and bent.

Item #	Desc	UPC	Vendor	CS/UOS	Location
80820034	1qt Conc.	022179100893	LG 5285	12/12	West

Florel Brand Growth Regulator-Residential

This plant growth regulator prevents unwanted nuisance fruit or nut formation on numerous trees listed on the label, including crabapple, flowering pear, flowering plum, maple, chestnut, olive, sweet gum (liquidambar), sour orange and more. **Available for sale in AZ, CA, CO, NM, NV, OR, UT, WA**

Item #	Desc	UPC	Vendor	CS/UOS	Location
80820397	1pt Conc.	022179105027	LG 4142	6/6	West
80820398	1qt Conc.	022179105034	LG 4146	6/6	West
80820399	1gal Conc.	022179105041	LG 4150	4/4	West

Florel Brand Growth Regulator-Dual

Not for sale in AK, CA, CO, WA

Item #	Desc	UPC	Vendor	CS/UOS	Location
80820395	1gal Conc.	022179100350	LG 4110	4/4	West

Sedgehammer

Selective herbicide for the control of nutsedge, horsetail, and other weeds. Can be used in turfgrass, ornamentals, landscaped areas, and non-crop areas. 5% Halosulfuron-methyl.

Not for sale in AK



Item #	Desc	UPC	Vendor	CS/UOS	Location
80820264	.5oz	714654514980	LG 5405	12/12	National

2024



Tree Feast™ 5-7-5

Monterey® Tree Feast™ is specifically formulated to help promote plant and root growth in trees. **Not for sale in AR, KY, MS, MO, NE, ND, SC, SD, VT, WV, WY**



Item #	Desc	UPC	Vendor	CS/UOS	Location
80820351	1 gal Conc.	760755100409	LG 7364	4/4	West

Iron Combo™

Iron Combo™ is a broad spectrum micronutrient fertilizer designed to help correct and prevent iron and other micronutrient deficiencies. The iron, copper, manganese and zinc are complexed in a soluble form ready for absorption. **Not for sale in AR, CA, KY, NE, NH, ND, SC, SD, VT, WV, WY**



Item #	Desc	UPC	Vendor	CS/UOS	Location
80820385	32 oz. RTS	022179105522	LG 7376	10/10	West
80820339	1qt. Conc.	022179105294	LG 7350	10/10	West
80820340	1 gal. Conc.	022179105300	LG 7352	4/4	West

Nutra-Gel Moisture retaining gel w/ Fertilizer Plus Iron

Nutra-Gel is a unique fertilizer and water retainer. Inside each granule are essential nutrients that assist in plant nutrition and an absorbent to retain moisture. **Not for sale in AR, IL, KY, MS, MO, MT, NE, NH, ND, OH, OK, PA, SC, SD, VT, WV, WY**



Item #	Desc	UPC	Vendor	CS/UOS	Location
80820384	8 oz.	022179105461	LG 7367	12/12	West

Iron Tree Treats

Monterey® Iron Tree Treats are readily soluble capsules formulated to help alleviate yellowing (iron chlorosis) and other micronutrient deficiencies in trees. **Not for sale in AR, FL, KY, MS, MO, MT, NE, NH, ND, SC, VT, WV, WY**



Item #	Desc	UPC	Vendor	CS/UOS	Location
80820350	Capsules	022179105348	LG 7360	8/8	West

Turf Booster

Turf Booster has been specially formulated for lawns and turf. Monterey® Turf Booster contains 3 forms of nitrogen for effective use during growth and development. The nutrients found in Monterey® Turf Booster may enhance turf growth and soil nutrition. **Not for sale in AR, KY, MD, MO, MT, NE, ND, SC, SD, VT, WV, WI, WY**



Item #	Desc	UPC	Vendor	CS/UOS	Location
80820401	1qt. RTS	022179105539	LG 7378	10/10	West
80820337	1qt. Conc.	760755020103	LG 7346	10/10	West
80820338	1gal. Conc.	760755100102	LG 7348	4/4	West

Pasture Fertilizer

Monterey pasture fertilizer is specially formulated to encourage strong growth of pasture grasses and legumes. Applying this fertilizer improves the growth of your pasture improving grazing for horses, cattle or other livestock. **Not for sale in SD**



Item #	Desc	UPC	Vendor	CS/UOS	Location
80820249	1 gal Conc.	022179104891	LG 7103	4/4	West

Seed Starter 1-1-1

The nutrients in Monterey® Seed Starter help promote growth of the seedling when applied to newly seeded lawns, vegetable gardens and other seed plantings. Improving soil nutrition encourages a vigorous root system for plants. **Not for sale in AR, FL, GA, KY, MS, MO, MT, NE, NH, ND, SC, SD, VT, VA, WV, WY**



Item #	Desc	UPC	Vendor	CS/UOS	Location
80820345	1 gal Conc.	022179105331	LG 7358	4/4	West

Dr. Iron Resealable Bag

Corrects iron deficiency fast with lasting results. Won't stain concrete or burn foliage. Environmentally friendly. Apply 3.5 lbs per 1,000 sq. ft. Controlled release for seasonlong feeding.



Item #	Desc	UPC	Vendor	CS/UOS	Location
80820136	7 lb. bag	022179102705	LG 7115	8/8	National
80820138	21 lb. bag	022179102477	LG 7122	4/4	West
80820139	40 lb. bag	022179101517	LG 7117	2/2	West



Codling Moth Trap & Lure

Codling moths are a worldwide pest that attacks apples, pears, walnuts and quince, so these are the trees to use it on. **Not for sale in CT, LA, NM, OK**

Item #	Desc	UPC	Vendor	CS/UOS	Location
80820167	2 traps	022179102279	LG 8500	12/12	West

Spider Trap

Pesticide-free sticky trap for catching spiders in homes, RV's, garages and patios, etc. Spiders wander in to hide or find food, and are trapped by the heavy sticky glue in the trap. **Not for sale in AL, AZ, CO, GA, HI, ID, IL, IN, KY, MD, MA, MS, MO, NV, NH, NM, ND, OH, OK, OR, PA, SD, UT, VA, WV, WY, DC**

Item #	Desc	UPC	Vendor	CS/UOS	Location
80820174	4 traps	022179103344	LG 8620	12/12	West

Peach Tree Borer Trap

Attracts and traps Peach Tree Borers. Use any time during the growing season to capture moths. Treat as appropriate to control pests. **Not for sale in CO, NM**

Item #	Desc	UPC	Vendor	CS/UOS	Location
80820173	2 traps	022179102712	LG 8710	12/12	West

Yellow Sticky Trap

Catch and monitor insects. Attracts insects by imitating a very healthy plant leaf. Catches insects at the onset of proliferation, so treatment can be applied before infestation causes damage to plants. **Not for sale in KY, NM, OK**

Item #	Desc	UPC	Vendor	CS/UOS	Location
80820386	5 traps	022179102309	LG 8800	12/12	West

Citrus Leafminer Trap

Control unwanted insects in your greenhouse, home, and garden. Pesky insects are attracted to the bright, yellow color and then killed by the powerful sticky glue. Eco-friendly and non-toxic. After use can be disposed of in your trash or compost. **Not for sale in CO, LA, OK**



Item #	Desc	UPC	Vendor	CS/UOS	Location
80820166	2 traps	022179102897	LG 8920	12/12	West



Herbicide Helper

Herbicide Helper is a Spreader / Penetrant for use with herbicides for improves performance. Herbicide Helper improves the Wetting of Foliage and gets better results for a faster Weed Kill. And Helps the herbicides stick to the targeted weeds. **Not for sale in ME**

Item #	Desc	UPC	Vendor	CS/UOS	Location
80820357	1 pt. Conc.	022179100138	LG 1104	6/6	West
80820356	8 oz. Conc.	022179101173	LG 1109	6/6	West

Mark-It Blue

MARK-IT BLUE is a concentrated blue colorant designed to provide temporary highly-visible evidence of spray application patterns. MARK-IT BLUE readily dissipates, is non-toxic and totally compatible with water-soluble solutions.

Item #	Desc	UPC	Vendor	CS/UOS	Location
80820303	1pt. Conc.	022179104624	LG 1142	12/12	West
80820115	8oz. Conc.	022179101395	LG 1130	12/12	West

Monterey® Magnify

Use on lawns, ornamentals and non-crop areas. Formulated with ammonium salts, non-ionic surfactants and anti-foaming agents. Enhances the biological activity and leaf-surface penetration of herbicides, defoliant and desiccants whose labels specify the addition of ammonium sulfate/nitrate and/or surfactants.

Not for sale in AR, ID, IL, KY, MA, ME, MS, ND, TN, UT

Item #	Desc	UPC	Vendor	CS/UOS	Location
80820366	1 qt. Conc.	022179104242	LG 1150	12/12	West

Garden Phos

For control of root rot, downy mildew, fire blight, sudden oak death (s.o.d.), phytophthora & pythium diseases and other listed diseases. Can be used as soil drench, foliar spray, or basal bark application.

Not for sale in NY

Item #	Desc	UPC	Vendor	CS/UOS	Location
80820301	1pt. Concentrate	022179104549	LG 3303	6/6	National
80820302	1 qt. Conc.	022179104556	LG 3307	6/6	West

Pentra-Bark®

Superior nonionic wetting agent, designed to improve penetration of water-based basal applications through bark. May be used in agriculture, horticulture, industrial, and forestry applications. Designed for fast-spreading, uniform distribution and absorption of spray on leaf and stem surface. **Not for sale in AR, MS, NY, UT**



Item #	Desc	UPC	Vendor	CS/UOS	Location
80820127	1 qt. Conc.		LG 1160	12/12	West

2024



Biting Insect Repellent

Best Yet is the ultimate in personal relief from Mosquitoes, Fleas, Flies, Ticks, Green Heads, Chiggers, No-See-Ums and Gnats. A light misting application of this Cedar Oil Solution will provide all day protection. It will not sweat off like DEET products or other natural insect repellents. Best Yet can be used on children of all ages and animals of any kind. It can be applied directly to the skin or over clothing.



Item #	Desc	UPC	Vendor	CS/UOS	Location
80120022	2.5 oz	081435624252	BY 125	24/24	East
80120023	4 oz. RTU	081435304284	BY 104	28/28	East

Garden Weed Preventer

The flower and garden weed preventer. Proven effective with 180 varieties of bulbs, flowers, roses, shrubs, trees and vegetables. Stops weeds before they start. Apply just once and enjoy weed-free gardens for up to 14 weeks. Ready to use granular form requires no measuring or mixing. Contains 1.47% Trifluralin.



Item #	Desc	UPC	Vendor	CS/UOS	Location
80350093	5.625 lb.	088685637933	2463795	4/4	National
80350096	13 lb. bag	088685637780	2463798	1/1	East
80350097	16 lb	088685638008	2463800	1/1	East
80350098	31.3 lb. bag	088685636776	2463802	1/1	East

2024

Preen

Extended Control Weed Preventer

Stop weeds before they start and prevent weeds from occurring for up to 6 months.

Not for sale in NY



Item #	Desc	UPC	Vendor	CS/UOS	Location
80350331	5 lb. Shaker	088685640926	2464092	24/24	National
80350583	10 lb	088685642067	2464206	1/1	East

Natural Vegetable Garden Weed Preventer

Enjoy a weed-free vegetable garden without all the work. Preen Natural Vegetable Garden Weed Preventer is the natural way to keep weeds from sprouting! Use the natural weed control in your fruit, vegetable, herb, and landscape beds anytime during the growing season to save time from back-breaking weeding. Formulated to control some of toughest weeds, like clover, bluegrass, crabgrass, foxtail, lambsquarters and plantain. Just sprinkle around established vegetables, herbs, and fruits once a month to prevent weeds from returning to your garden. Children and pets can play in the area immediately after application. **Not for sale in SD**



Item #	Desc	UPC	Vendor	CS/UOS	Location
80350343	5 lb.	088685638008	2464153	4/4	National

Garden Weed Preventer Plus Plant Food

Prevents weeds and feeds plants in one easy step. Balanced fertilizer promotes abundant blooms, increased yields and strong root development. Safe for use around over 200 established flowers, vegetables, trees and shrubs. One application fertilizes your plants and prevents weeds for up to three months.



Item #	Desc	UPC	Vendor	CS/UOS	Location
80350103	5.625 lb	088685639029	2163902	4/4	National
80350106	16 lb drum	088685639067	2163907	1/1	East

YOU'VE GOT A PERENNIAL PARTNER IN US

Quality inputs yield the best finished crops. Griffin partners with accomplished perennial breeders and producers to bring you the best in seed, cuttings and young plants. Explore our seed and vegetative perennial assortments in our Seed & Plant catalog.

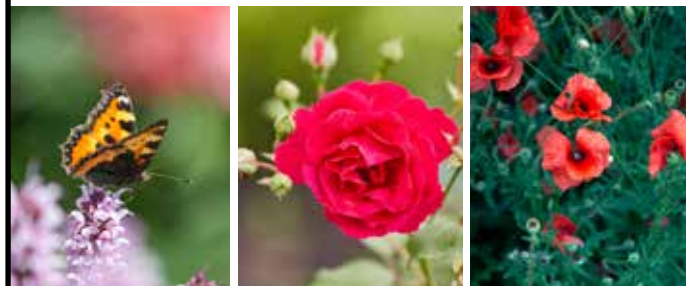



Disposable Yellowjacket Trap (A)

Effective in targeting and trapping all of the major species of yellowjacket found in North America. Perfect for picnics and camping trips. No killing agents - Once trapped, yellowjackets simply drown in the liquid. Water-soluble attractant included - Just add water and hang.

Item #	Desc	UPC	Vendor	CS/UOS	Location
80220002	Trap	042853776039	YJTD-DB12-E	12/12	East
80220035	Display Box	042853775032	YJTD-DB12-W	12/12	West

W-H-Y® Trap - Wasp • Hornet • Yellowjacket (B)

Captures multiple species of stinging pest insects: Paper Wasps, Bald-faced Hornets, European hornets and Yellowjackets and more. The RESCUE® team of scientists has spent years developing a combination of three attractants and a distinctive double chamber design for the W-H-Y Trap. Non toxic mode of action.

Item #	Desc	UPC	Vendor	CS/UOS	Location
80220011	Trap	042853801007	WHYTR-BB8	8/8	National
80220093	Refill Box	042853811006	WHYTA-DB6	6/6	National

Big Bag Fly Trap (C)

Disposable trap designed for areas with heavy fly concentrations. It's proven to catch common nuisance and filth flies, including house flies, false stable flies, blow flies, blue and green bottle flies, flesh flies, face flies and many others. Easy to use - just add water and the fast-acting attractant starts luring flies to the trap. Holds up to 40,000 flies.

Item #	Desc	UPC	Vendor	CS/UOS	Location
80220001	Fly Bag Trap	042853797010	BFTD-DB12	12/12	National

TrapStik for Wasps (D)

The TrapStik® for Wasps catches paper wasps, carpenter bees and mud daubers. Catches queens and workers, from spring through fall. Can be placed near a nest to reduce populations.

Item #	Desc	UPC	Vendor	CS/UOS	Location
80220032	Wasp TrapStik	042853500016	TSW-BB6	6/6	National
80220095	Display 48-pk	042853500016	TSW-FD48	1/1	National

TrapStik for Flies (E)

The TrapStik® for Flies uses VisiLure™ technology to lure flies with appealing colors and a multi-dimensional pattern. Flies are attracted by the colors and patterns on the TrapStik®, then get stuck to the adhesive surface. Catches common house flies, cluster flies, fruit flies, and gnats.

Item #	Desc	UPC	Vendor	CS/UOS	Location
80220031	Fly TrapStik	042853400002	TSF-BB8	8/8	National

Japanese & Oriental Beetle Trap (F)

Catches two destructive pests: the Japanese beetle and the Oriental beetle. An all-in-one trap with no accessories to buy. New easy-lock bottom allows the trap to be emptied and reused; and the floral and pheromone lure lasts the entire beetle season. The double-layer nylon bag is highly durable and the design ensures the bag stays attached. Catch capacity is four times larger than the competition.

Item #	Desc	UPC	Vendor	CS/UOS	Location
80220005	Beetle Trap	042853780487	JBTZ-DB12	12/12	East

Disposable Fly Trap (G)

Fast-acting attractant dissolves and activates quickly once water is added. Proven to catch common nuisance or filth flies including house flies, cluster flies, false stable flies, blow flies, bottle flies, flesh flies and others. Place outdoors near household garbage bins, compost piles, dog kennels and other areas with flies. Sanitary; no need to touch the attractant or the flies. Holds up to 20,000 flies.

Item #	Desc	UPC	Vendor	CS/UOS	Location
80220004	12piece Display Box	042853773014	FTD-DB12	12/12	National

Fruit Fly Trap (H)

Indoor trap uses a food-based lure and color proven attractive to fruit flies. Catches fruit flies that congregate and breed near fruit, vegetables and food scraps. Simply add the liquid attractant to the trap and it starts catching fruit flies in minutes. Each trap comes with a 30-day supply of attractant and is reusable with fruit fly trap attractant refills. Safe to use around food. Non-toxic. Once caught, fruit flies will drown in the non-toxic liquid attractant.

Item #	Desc	UPC	Vendor	CS/UOS	Location
80220087	Trap	042853600006	FFTR-BB4	4/4	National
80220053	12piece Display	042853620004	FFTA-DB12	12/12	National

Ant Bait Stations

A dual-bait formula that includes protein and carbohydrate in a form that is easy to ingest and transport. When placed where ant activity is seen, the foraging ants enter the bait station to find food and their colony. This will not only kill the workers but also will wipe out the queen and next generation of ants. Mess-Free/won't spill. Child Resistant. Visible results over night. Ants find it fast.



Item #	Desc	UPC	Vendor	CS/UOS	Location
80220145	4 Pack Box	10042853640009	AB4-SF12	4/4	National

2024



Carpenter Bee Trap

RESCUE Carpenter Bee TrapStik employs our exclusive VisiLure colors and patterns proven to attract carpenter bees. Our TrapStik works like nothing else on these pests. To protect wildlife from the sticky surface, we added bird guards.



Item #	Desc	UPC	Vendor	CS/UOS	Location
80220106	Carpenter Bee Trap	042853520007	CBTS-BB6	6/6	National

FlyPad Trap

This is not your average sticky fly trap. FlyPad's unique corrugated texture features glue-filled grooves to catch flies, while the ridged surface stays clean to the touch during setup and disposal. When it comes to trapping flies, RESCUE!



Item #	Desc	UPC	Vendor	CS/UOS	Location
80220148	2pk shelf pk of 16	042853470005	FP2-DB16	16/16	National

Deck & Patio Fly Trapstik

Uses our exclusive VisiLure® technology to draw insects with appealing colors and a multi-dimensional pattern. Flies are attracted by the colors and patterns, then get trapped on the sticky surface.



Item #	Desc	UPC	Vendor	CS/UOS	Location
80220105	Fly Trapstik	042853420017	TSBF-BB6	6/6	National

Disposable Yellow Jacket Trap

Rescue! Disposable Yellowjacket Trap is effective in targeting and trapping all of the major species of Yellowjacket found in North America. Lured by the powerful scent, Yellowjackets enter through the top cap and drown in the water. Ideal for picnics or camping, Disposable Yellowjacket Traps have convenient Yellowjacket control in the bag.



Item #	Desc	UPC	Vendor	CS/UOS	Location
80220035	Display Box	042853775032	YJTD-DB12-W	12/12	West



Bird Bath & Fountain Maintenance

This safe but fast-acting enzyme-based formula reduces and eliminates muck, dead leaves, and odors. When applied to fresh water it will super charge naturally occurring bacteria.



Item #	Desc	UPC	Vendor	CS/UOS	Location
82430062	8oz.	768980880028	88002	12/12	National

Fountain Clarifier

This fountain enzyme clarifier product is designed to keep your fountain clean and clear by breaking down organic waste, debris and other contaminants. Simply add Fountain Clarifier to your fountain water, and let it work its magic.



Item #	Desc	UPC	Vendor	CS/UOS	Location
82430063	8oz.	768980880035	88003	12/12	National

Fountain Algaecide & Clarifier

Effectively eliminates green water algae, string and hair algae, blanketweed algae and others. Non-hazardous, non-staining, and non-foaming when used as directed. Controls green water to keep pond water clean and clear in ornamental ponds and water gardens.



Item #	Desc	UPC	Vendor	CS/UOS	Location
82430068	8oz.	768980880158	88015	12/12	National

Multi-Use 20% Vinegar

Natural and safe 20% industrial strength white vinegar. Multi-use and perfect for cleaning, laundry, automotive and gardening. Perfect replacement for harmful household chemicals.



Item #	Desc	UPC	Vendor	CS/UOS	Location
82430065	1 gal Conc.	768980880097	88009	4/4	National
82430067	1 qt Conc.	768980880110	88011	12/12	National



Sticky Trap Houseplant Insect Traps

Yellow sticky traps for indoor or outdoor use. Attracts and traps gnats, whiteflies, aphids, and other insects hiding in your potted plants. Non toxic. Pesticide free



Item #	Desc	UPC	Vendor	CS/UOS	Location
80530127	12 traps per pack	018506001858	185-24	24/24	National

Mosquito Bits®

Simply sprinkle in any standing water - including water gardens. Like the Mosquito Dunks®, this product kills mosquito larvae before they become adult (biting) mosquitoes. Quick Kill Bits™ will eliminate mosquito larvae within 24 hours. The Mosquito Bits® are now labeled to control Fungus Gnats in plant beds or pots!



Item #	Desc	UPC	Vendor	CS/UOS	Location
80530009	8 oz.	018506001162	116-12	12/12	National
80530011	30 oz.	018506001179	117-6	6/6	National

Deer Ban®

Unique Gel-tablet application provides effective year-round protection from wildlife damage. Uses predator urine triggering animal flight response. Natural and biodegradable. Drop capsules every 5-10 ft around coverage area or place in planters. Perfect around gardens and ornamentals. Easy-to-use and odorless to humans; effective up to 90 days.



Item #	Desc	UPC	Vendor	CS/UOS	Location
80530052	50 Pack	018506020019	2001	12/12	National

Mosquito Dunks®

Kills mosquitoes before they are old enough to bite. Made with BTi, a natural, soil borne bacteria. Approved for use around fish, birds, wildlife, people, pets and plants. Kills mosquito larvae for 30 days or longer. Simply place a floating Mosquito Dunk® in areas where water collects around your home. Each Dunk® will take care of up to 100 sq. ft. of water surface regardless of depth. Approved for organic production.



Item #	Desc	UPC	Vendor	CS/UOS	Location
80530001	2 Dunks	018506001025	102-12	12/12	National
80530003	6 Dunks	018506001100	110-12	12/12	National

Year-Round® Horticultural Oil Spray

Versatile plant protection without the use of synthetic toxins. Protects garden plants and ornamentals in and around the home; use on fruit trees and edibles up to the day of harvest. Controls aphids, spider mites, fungus gnats, scale, white fly and many other common plant pests. Odorless and non-irritating. Highly refined oil will not burn or brown plants even in direct sunlight. Approved for organic gardening.



Item #	Desc	UPC	Vendor	CS/UOS	Location
80530020	1 gal. Con.	018506001209	120-4	4/4	National
80530065	Pint Con.	018506001131	113-6	6/6	National
80530066	Quart Con.	018506001148	114-6	6/6	National
80530067	RTS qt.	018506001216	121-6	6/6	National

Year-Round® Horticultural Oil Spray – for Gardens

Premixed Year-Round® Spray Oil in a convenient quart spray bottle. Labeled specifically for outdoor use. For organic gardening.



Item #	Desc	UPC	Vendor	CS/UOS	Location
80530022	32 oz. RTU	018506001223	122	12/12	National

Year-Round® Horticultural Oil Spray House Plant

Premixed Year-Round® Spray Oil in a convenient quart spray bottle. Labeled specifically for indoor use. For organic gardening. Ready-to-use for house plants.



Item #	Desc	UPC	Vendor	CS/UOS	Location
80530023	32 oz. RTU	018506001230	123	12/12	National

Tick Take Tick Removal Spoons

The Summit Tick Take Tick Removal Spoons are a safe and easy way to remove ticks from people and pets. Comes in a handy pack of 3 – one for home, car, backpack, etc. Small, lightweight design lets you take a spoon along when gardening, hiking or doing other outdoor activities.



Item #	Desc	UPC	Vendor	CS/UOS	Location
80530093	3 pack	018506001537	153	12/12	National



Insect Dust

Made from 100% Food-Grade Diatomaceous Earth, a fossilized hard shelled algae. Insect Dust is like crawling over broken glass to insects but is harmless to pets and humans. Use indoors or out, around the foundation of your home as a barrier, on vegetable plants, ornamentals, houseplants, on slugs, snails, ant mounds, earwigs, in cracks and crevices, sprinkle on mattresses to kill bed bugs, on carpet to kill fleas or anywhere else insects are found.



Item #	Desc	UPC	Vendor	CS/UOS	Location
80660021	4.4 lb.	699064500207	50020-7	6/6	East

Milky Spore Powder

A one time application using only one teaspoonful every 4 feet in a checker board pattern on your lawn, or use the Lawn and Garden Dispenser. 10 oz.- will treat 2,500 sq. ft. Apply anytime the ground is not frozen. Ten year performance guarantee on the Japanese Beetle Grub (can last up to twenty years). Not harmful to man, animals or the environment, safe to use around water ways. Kills the grub stage of the Japanese Beetle.



Item #	Desc	UPC	Vendor	CS/UOS	Location
80660032	10 oz.	699064800109	80010-9	6/6	East



Zinc Homeowner Bait

Containing the acute toxin Zinc Phosphide (2.0%), this single-feed formula is presented on wheat for use to control Pocket Gophers. Available in 1 lb. for homeowners. No permit and/or license is required.

Not for sale in AL, AK, CT, DE, FL, GA, HI, ID, IL, IN, KY, ME, MD, MA, MI, MS, NH, NJ, NY, NC, OH, PA, RI, SC, TN, VT, VA, WV, WI, WY, DC



Item #	Desc	UPC	Vendor	CS/UOS	Location
82590001	1lb	091017600161	60016	12/12	West

Gopher Getter Type 2

Ideal for managing Pocket Gopher infestations. Containing .005% Diphacinone, this formula is a multiple-feed solution requiring the gopher to eat the bait 3-4 days continuously. An anise coating is adhered to milo grain, acting as an attractant and producing high palatability among Pocket Gophers. **Not for sale in AL, AR, CO, CT, DE, FL, GA, HI, ID, IL, IN, IA, KS, KY, ME, MD, MA, MI, MN, MS, MO, MT, NH, NJ, NM, NY, NC, ND, OH, PA, RI, SC, SD, TN, VT, VA, WV, WI, DC**



Item #	Desc	UPC	Vendor	CS/UOS	Location
82590002	1lb	091017210162	21016	12/12	West
82590003	5lb	091017210056	21005	6/6	West

Ground Squirrel Bait

Bait is pelletized to emulate their natural food source and encourage them to eat the bait, not to store it. It contains the anticoagulant Diphacinone (.005%) and is a multiple-feed solution requiring the rodent to consume 3-4 days of continuous feeding. Bait station required.

Not for sale in AL, AK, AR, CO, CT, DE, FL, GA, HI, IL, IN, IA, KS, KY, ME, MD, MA, MI, MN, MS, MO, MT, NE, NH, NJ, NY, NC, ND, OH, OK, PA, RI, SC, SD, TN, TX, VT, VA, WV, WI, WY, DC



Item #	Desc	UPC	Vendor	CS/UOS	Location
82590006	4lb	091017310046	31004	6/6	West
82590007	20lb	091017310206	31020	1/1	West
82590019	Station	091017390000	39000	6/6	West

Rat & Mouse Bait Station

Molded of heavy-duty plastic to withstand any type of abuse, bait station is sized for rat and mouse control applications. Measuring at 10" x 6" x 3 1/4", it is ideal to place under work benches, cabinets, warehouse pallets, etc. Includes a child resistant cap for refilling and provisions to anchor it to the ground.



Item #	Desc	UPC	Vendor	CS/UOS	Location
82590020	Station	091017390017	39001	6/6	West

Gopher Getter Midget with Bait Type 2

A safe and simple tool that gives the occasional user a reasonable method of controlling Pocket Gophers. Applicator tool dispenses bait subsoil, likely only allowing the gopher to come into contact with the bait and helps to prevent secondary exposure. **Not for sale in AL, AK, AR, CO, CT, DE, DC, FL, GA, ID, IA, IL, IN, HI, KS, KY, MA, ME, MD, MI, MN, MO, MS, MT, NC, ND, NH, NJ, NM, NY, OH, PA, PR, RI, SC, SD, TN, VA, VT, WV, WI**



Item #	Desc	UPC	Vendor	CS/UOS	Location
82590027	Midget w/ 1lb Bait	091017706009	70101	6/6	West

Gopher Getter Applicator with Bait Type 2

The Wilco Gopher Bait Applicator is recommended for anyone with several acres, or for commercial use requiring extensive gopher control. This tool is a hand operated probe that dispenses Wilco's gopher bait underground into the gopher's natural runway. This keeps the bait away from birds, pets and children. There is no danger of harming children or other animals when used as instructed. **Not for sale in AL, AK, AR, CO, CT, DE, DC, FL, GA, ID, IA, IL, IN, HI, KS, KY, MA, ME, MD, MI, MN, MO, MS, MT, NC, ND, NH, NJ, NM, NY, OH, PA, PR, RI, SC, SD, TN, VA, VT, WV, WI**



Item #	Desc	UPC	Vendor	CS/UOS	Location
82590022	Applicator w/ 1lb Bait	091017701004	70601	8/8	West

CROP SUPPORT



CHECK OUT OUR
CLEARANCE ITEMS!



Griffin Greenhouse Retail WAREHOUSE Shipping Map

We are now shipping nationwide!

NATIONAL



2024

Refer to location key:

National items are stocked nationally
 Select items are sold East or West only; no exceptions

8" Kaleidoscope Planter

Premium plastic modular planter can be displayed individually each planter has a removable saucer ideal for succulents or shallow rooted planted.

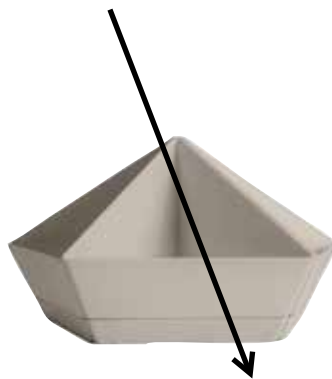

Item #	Desc	UPC	Vendor	CS/UOS	Location
80282643	Vanilla Bisque	770932844170	KDP08000A58	6/6	National

Where is the pricing?

1. Scan QR code on Chapter Pages to see pricing on Griffins.com
2. Contact your Griffin Sales Representative
3. Call into Griffin Customer Service 800.888.0054





Diamond Espalier Trellis

Heavy Duty Espalier Trellis with Diamond Accent can be used for freestanding or in-ground. Redwood construction resists decay when directly on the ground, enhances the beauty of your outdoor space, provides a natural wood solution for climbing plants and vines, creates filtered sunlight and shade for an outdoor space, and adds visual interest to fences or walls.



Item #	Desc	UPC	Vendor	CS/UOS	Location
82620004	3ft X 7ft	604280006372	37NDE	2/2	West



Fan Trellis

Light Duty Fan Trellis can be used for freestanding or on ground. Redwood construction resists decay when directly on the ground, enhances the beauty of your outdoor space, provides a natural wood solution for climbing plants and vines, creates filtered sunlight and shade for an outdoor space, and adds visual interest to fences or walls.

Item #	Desc	UPC	Vendor	CS/UOS	Location
82620001	2x4 ft	604280004040	24NTFAN	6/6	West
82620002	6 ft	604280004262	6NTFAN	6/6	West
82620003	8 ft	604280004989	8NTFAN	6/6	West
82620018	Red 6 ft	791167736009	6RGTFFAN	6/6	West



Fan Espalier Trellis

Light Duty Trellis can be used for freestanding or in-ground. Redwood construction resists decay when directly on the ground, enhances the beauty of your outdoor space, provides a natural wood solution for climbing plants and vines, creates filtered sunlight and shade for an outdoor space, and adds visual interest to fences or walls.

Item #	Desc	UPC	Vendor	CS/UOS	Location
82620005	2x4 ft	604280004248	24NEFAN	6/6	West
82620006	2.5x7 ft	604280004224	2127NEFAN	6/6	West
82620007	3x4 ft	604280004033	34NEFAN	6/6	West
82620016	Green 3'x3'	604280005030	3GGEFLR	6/6	West

Heavy Duty Fan Trellis

Heavy Duty Espalier Trellis can be used for freestanding or in-ground. Redwood construction resists decay when directly on the ground, enhances the beauty of your outdoor space, provides a natural wood solution for climbing plants and vines, creates filtered sunlight and shade for an outdoor space, and adds visual interest to fences or walls.



Item #	Desc	UPC	Vendor	CS/UOS	Location
82620008	3.5ft x 6ft	604280006266	3126NEFANHD	2/2	West

House Plant Trellis

Light Duty Trellis can be used for freestanding or in-ground applications or attached to existing structures. Redwood construction resists decay when directly on the ground, enhances the beauty of your outdoor space, provides a natural wood solution for climbing plants and vines, creates filtered sunlight and shade for an outdoor space, and adds visual interest to fences or walls.



Item #	Desc	UPC	Vendor	CS/UOS	Location
82620009	1.5ft x 2ft	604280004019	1122NBEFLR	6/6	West

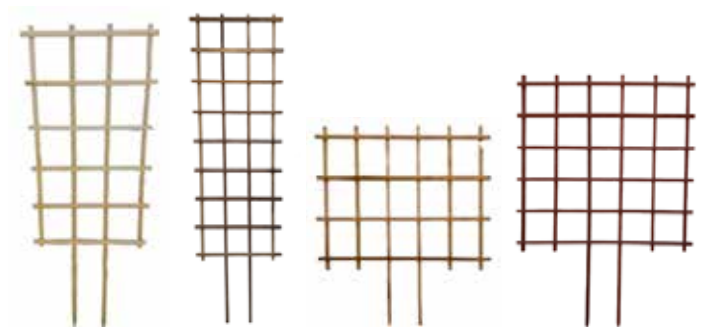

Espalier Trellis

Light Duty Espalier Trellis can be used for freestanding or in-ground. Redwood construction resists decay when directly on the ground, enhances the beauty of your outdoor space, provides a natural wood solution for climbing plants and vines, creates filtered sunlight and shade for an outdoor space, and adds visual interest to fences or walls.

Item #	Desc	UPC	Vendor	CS/UOS	Location
82620017	22"x40"	850044240067	2240NGE	6/6	West
82620010	2'X7'	604280004255	27NE	6/6	West
82620012	3'x3.5'	604280004217	3312NE	6/6	West
82620024	3.5'x5'	604280004095	3125NSE	6/6	West
82620013	5'x5'	604280005108	55NGE	6/6	West
82620011	Green 3'x3'	791167736504	33GGE	6/6	West
82620015	Green 5'x5'	604280005122	55GGE	6/6	West
82620014	Red 4'x4'	791167736702	44RGE	6/6	West



Majestic

Heavy Duty Fan Trellis can be used for freestanding or in-ground applications or attached to existing structures. Redwood construction resists decay when directly on the ground, enhances the beauty of your outdoor space, provides a natural wood solution for climbing plants and vines, creates filtered sunlight and shade for an outdoor space, and adds visual interest to fences or walls.



Item #	Desc	UPC	Vendor	CS/UOS	Location
82620022	2'x7'	604280006693	27NME	2/2	West



Heavy Duty Trellis

Made with 1"x2" pieces of wood. Light Duty Trellis can be used for freestanding or in-ground. Redwood construction resists decay when directly on the ground, enhances the beauty of your outdoor space, provides a natural wood solution for climbing plants and vines, creates filtered sunlight and shade for an outdoor space, and adds visual interest to fences or walls.

Item #	Desc	UPC	Vendor	CS/UOS	Location
82620019	1.5'x3.5'	604280006143	112312NEHD	6/6	West
82620020	2'x3.5'	604280006242	2312NEHD	6/6	West
82620021	3'x3.5'	604280006341	3312NEHD	6/6	West
82620029	2'x7.5'	604280006280	2712NLTHD	2/2	West
82620030	4'x6'	604280006464	46NLTHD	2/2	West
82620031	4'x7.5'	604280006488	4712NLTHD	2/2	West

2024

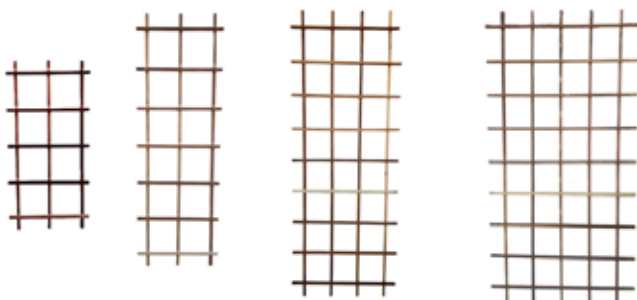

Ladder Trellis

Trellises are for vines, fruit trees, and other plants that need upward growth. Not for standing on.

Item #	Desc	UPC	Vendor	CS/UOS	Location
82620028	Red 2'x4'	850044240074	24RLT	6/6	West
82620025	2'x6'	604280004415	26NLT	6/6	West
82620026	3'x8'	604280004439	38NLT	6/6	West
82620027	4'x8'	604280004842	48NLT	6/6	West

Square Espalier

Light Duty Square Trellis can be used for freestanding or in-ground applications or attached to existing structures. Redwood construction resists decay when directly on the ground, enhances the beauty of your outdoor space, provides a natural wood solution for climbing plants and vines, creates filtered sunlight and shade for an outdoor space, and adds visual interest to fences or walls.



Item #	Desc	UPC	Vendor	CS/UOS	Location
82620023	3'	604280004026	3NSE	6/6	West

Simple Ties w/ Nails

Used to secure tree supports



Item #	Desc	UPC	Vendor	CS/UOS	Location
82620063	24" 12 bags of 6 pack	850044240005	24ST6PK	1/1	West
82620064	32" 12 bags of 6 pack	850044240012	32ST6PK	1/1	West
82620065	36" 12 bags of 6 pack	850044240029	36ST6PK	1/1	West
82620066	24" 500 case	850044240081	24ST	1/1	West
82620067	32" 500 case	850044240098	32ST	1/1	West
82620068	36" 500 case	850044240159	36ST	1/1	West

Redwood Planter

This smooth natural redwood planter from A&G Agricultural Supply features rounded formal corners. It is smooth, sturdy, and hand made. Beautiful for outdoor plants.



Item #	Desc	UPC	Vendor	CS/UOS	Location
82620050	8"x10"x24"	604280015022	81024FP	1/1	West
82620051	8"x10"x36"	604280015039	81036FP	1/1	West
82620052	8"x10"x48"	604280015046	81048FP	1/1	West
82620053	15"x14"x36"	604280015114	151436FP	1/1	West
82620054	15"x14"x48"	604280015121	151448FP	1/1	West
82620055	18"x18"x13"	604280015183	18181312FP	1/1	West



Redwood

These stakes are for tree support.

Item #	Desc	UPC	Vendor	CS/UOS	Location
82620032	1"x3'	604280560034	113R	25/25	West
82620033	1"x4'	604280030049	114R	25/25	West
82620034	1"x5'	604280030056	115R	25/25	West
82620035	1"x6'	604280030063	116R	25/25	West
82620036	1"x7'	604280030070	117R	25/25	West
82620037	1"x8'	604280030087	118R	25/25	West
82620038	1"x2"x7'	604280056179	127R	12/12	West
82620039	1"x2"x8'	604280056186	128R	12/12	West
82620040	2"x2"x6'	604280030223	226R	6/6	West
82620041	2"x2"x7'	604280030278	227R	6/6	West
82620042	2"x2"x8'	604280030278	228R	6/6	West

Pine Poles

Treated Pine Poles are essential, pre-treated wooden poles designed for a range of agricultural and outdoor applications. These durable poles offer reliable support and structure for various needs such as fencing, construction, and landscaping. Resistance against decay and pests, makes them a practical choice for long-lasting projects in agriculture and outdoor settings. These stakes are for tree support.



Item #	Desc	UPC	Vendor	CS/UOS	Location
82620061	Treated 8'	850044240036	BYKT	1/1	West
82620062	Untreated 8'	850044240043	BYKU	1/1	West



Green

Great for use with shrubs, vines, tomatoes, and vegetables. Lightweight but durable.

Item #	Desc	UPC	Vendor	CS/UOS	Location
82620043	1"x3'	850044240142	113GR	25/25	West
82620044	1"x4'	604280031046	114GR	25/25	West
82620045	1"x5'	604280031046	115GR	25/25	West
82620046	1"x6'	604280031060	116GR	25/25	West
82620047	2"x2"x8'	604280031121	228GR	9/9	West

Redwood Window Box

This is perfect for any garden or landscape. Handmade from beautiful California redwood. Banded with stainless steel bands.



Item #	Desc	UPC	Vendor	CS/UOS	Location
82620056	2'	604280017026	2BWB	1/1	West
82620057	3'	604280017033	3BWB	1/1	West
82620058	4'	604280017040	4BWB	1/1	West



Coco Grow Pole

These poles are made with all-natural coconut coir that helps to retain moisture and nutrients that aid in overall plant health. Providing vertical support for climbing plants and vines, each pole includes a hollow PVC pipe that is stackable and allows for ample drainage.



Item #	Desc	UPC	Vendor	CS/UOS	Location
80690896	1.57 x 15.75"	849637006968	CP01	36/36	East
80690897	1.77 x 23.62"	849637006975	CP02	20/20	East
80690898	1.77 x 35.43"	849637006982	CP03	36/36	East

Bendable Coco Grow Pole

In addition to providing versatile support for climbing plants and vines, these bendable coco fiber poles aid in retaining moisture and nutrients for overall plant health. Each pole includes a flexible wire with the ability to create unique shapes and add visual appeal to your plants.

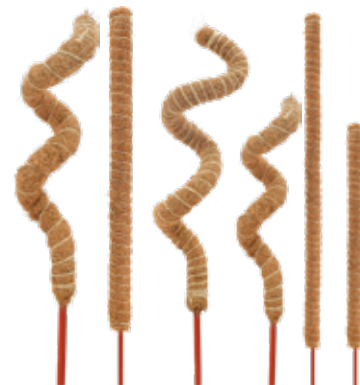

Item #	Desc	UPC	Vendor	CS/UOS	Location
80690964	1.5 x 24"	849637009037	CP07	20/20	East
80690965	1.5 x 36"	849637009044	CP08	36/36	East

Plastic Grow Pole

Our Plastic Grow Pole is crafted from toughened PET material, ensuring exceptional durability and long-lasting support for your plants. Fill with moss, coco coir, or other medium and watch your plants thrive with this high-quality pole.



Item #	Desc	UPC	Vendor	CS/UOS	Location
80691029	2.4x17"	849637009907	CP11	36/36	East

BOSMERE

Wren Scroll Pot Trellis

Graceful plant support for potted plants and in the garden. Heavy gauge green vinyl coated steel.



Item #	Desc	UPC	Vendor	CS/UOS	Location
82010677	24"x10"	721082125152	L515	12/12	National

Nutscene Twine Balls

A 164' spool of 3-ply twine in 10 colors: lime green, green, natural, dark blue, sky blue, orange, pink, black, red and purple.



Item #	Desc	UPC	Vendor	CS/UOS	Location
82010191	Assort.Colors 164' Ea.Ball	5012519430150	K808	36/36	National

Net Grow Tunnel

The durable, green poly mesh net grow tunnel features drawstring ends and is wrapped over strong galvanized steel hoops. The mesh on this grow tunnel protects your young plants from strong sunlight while still allowing light and rain to filter through. The galvanized steel hoop frame and easy drawstring ends make this grown tunnel even more practical. Plus, it folds for easy storage.



Item #	Desc	UPC	Vendor	CS/UOS	Location
82010940	118"L x 17.75"W x 17.75"H	721082128436	L843	5/5	National



Dalen



Trellis Netting 7" Reach Through Nylon Mesh

Weatherproof nylon scrog netting proudly made in the USA with premium quality, heavy duty 7" mesh and not easy to tear.

Item #	Desc	UPC	Vendor	CS/UOS	Location
82170054	5' X 15'	016069000059	TP-15C	12/12	National
82170055	5' X 30'	016069000196	TP-30C	12/12	National
82170056	5' X 60'	016069001667	TP-60	12/12	National

Deer-X Protective Netting

Keep destructive deer away from your garden, vegetables, fruits, shrubs, trees or flowers with this high-quality garden fence animal barrier.

Item #	Desc	UPC	Vendor	CS/UOS	Location
82170026	Premium 7'X50'	016069006259	DXP-12	12/12	National
82170024	7' X 100' / Cut Case Display	016069000493	DX-7	6/6	National
82170025	14' X 75'	016069000509	DX-14	6/6	National

Bird-X Protective Netting

Bird-X protects fruits and berries from thieving birds and other garden pests. The durable polypropylene mesh will protect your plants ensuring that birds and pests don't destroy them. The netting is easy to install and is available in multiple sizes.

Item #	Desc	UPC	Vendor	CS/UOS	Location
82170019	7' X 20' /Cut Case Display	016069000073	BN-1	12/12	National
82170020	14' X 14' /Cut Case Display	016069000080	BN-2	12/12	National
82170023	14' X 75'	016069000158	BN-5	6/6	National
82170022	14' X 45' /Cut Case Display	016069000141	BN-4	6/6	National
82170021	28' X 28'	016069000134	BN-3	6/6	National

Harvest-Guard Premium Blanket

During the winter, these protectors offer just the right air, light, and waterpermeability to promote a safer environment for your plants while helping trap heat and moisture to speed up germination to improve crop yield.

Item #	Desc	UPC	Vendor	CS/UOS	Location
82170076	10'x12'	016069004989	HGP-1012	6/6	National
82170077	10'x20'	016069004996	HGP-1020	4/4	National



Kwik Grips Plant Ties

Kwik Grips Plant Ties are an easy-to-use, multi-purpose solution for securing branches and plants across all seasons. The soft, flexible “hook and loop” design provides a simple method of securing plants, vines, branches, wraps, and covers. There are also multiple securing uses outside of the garden.



Item #	Desc	UPC	Vendor	CS/UOS	Location
82170048	25' Roll	016069005184	SG25-12	12/12	National

Twist Tie with Cutter

Easily and safely secure several plants to existing supports using these Gardeneer Twist Tie Plant Securers with Cutter. Using supports throughout your garden helps your favorite plants or crops grow upright, fostering healthy root systems. These rolls each include 100' of sturdy twist ties, made from lasting, plastic coated wire.



Item #	Desc	UPC	Vendor	CS/UOS	Location
82170047	100' Roll	016069004361	TWST-100	15/15	National

Stretch Tie

Secure your large plants to their stakes using the Gardeneer Stretch Tie Gardener's Wrap. This innovative material easily wraps around your plants to help keep them upright while growing. The wrap expands with the growth of your plant, preventing damage to the stem. The 0.5" width is perfect for keeping the ties unobtrusive, and the 150 foot length will yield several sturdy ties. Use the durable Stretch Tie Gardener's Wrap to help your plants grow tall and strong.



Item #	Desc	UPC	Vendor	CS/UOS	Location
82170196	1/2" x 150'	016069004354	ST-150	12/12	National

Insect Guard

A protective garden cover that helps keep bugs and swarming insects away from your plants. Our outdoor plant covers are made using non-woven fabric that allows sunlight and air to pass through. They are reusable to provide protection for your plants year after year. You can easily cut our outdoor plant covers to wrap them around small bushes or use them on multiple small crop patches.



Item #	Desc	UPC	Vendor	CS/UOS	Location
82170157	5' x 40'	016069006907	ING-40	8/8	National



Mow-Over Tree Stake Kit

Protect trees for easy mowing without trimming around stakes.

Item #	Desc	UPC	Vendor	CS/UOS	Location
82170065	Tree Staking Kit	016069000721	TSD-12	12/12	National

Garden Staples Shelf Display

Secure landscape fabrics and films, garden netting, floating garden covers and burlap tightly to the ground. Constructed of durable steel, staples are easy to push into and pull out of the ground.

Item #	Desc	UPC	Vendor	CS/UOS	Location
82170013	4" 20-Pack	016069003937	GS-20	24/24	National
82170015	4" 40-Pack	016069004743	GS-40BW	24/24	National

Harvest-Guard Roll Display

All-season protection blanket against Frost, Insects, Birds, and Heavy Rain.

Item #	Desc	UPC	Vendor	CS/UOS	Location
82170073	40"x50'	016069004019	GF-4050	28/28	National

Weed-Shield® Fabric Barrier

Use the grid pattern on this landscape fabric for easy garden layout and planting.

Item #	Desc	UPC	Vendor	CS/UOS	Location
82170202	3' x 50'	016069003067	WS3-50	20/20	National
82170201	3' x 100'	016069003074	WS3-100	12/12	National

Baby Owl

Add-on to your fake owl family. Grow more in your garden with this cute little baby Great Horned Owl companion that stands 10.6" tall.



Baby Owls are also known as Owlets!

Item #	Desc	UPC	Vendor	CS/UOS	Location
82170154	10.6"	016069006846	OWB-8	8/8	National

Rotating-Head Owl

natural's patented decoy owl to scare birds is here to take all the fuss out of driving rodents, pests, and annoying birds away from your deck, roof, rafters, boats, windows, or veranda.

Item #	Desc	UPC	Vendor	CS/UOS	Location
82170158	18"	016069006921	RHO4-CUS	4/4	National



LANDSCAPE FABRIC

Suppresses weed growth around plants | *Easy-to-use*

3 year Weed Barrier®

An entry-level 1 oz. garden fabric. Allows air, water and nutrients to pass through. It conserves soil moisture and promotes plant growth. UV treated fabric.



Item #	Desc	UPC	Vendor	CS/UOS	Location
80010821	1oz. 3' x 50'	042579824304	DWB10350	28/28	National
80010820	1oz. 3' x 100'	042579824311	DWB103100	15/15	National

2024

6 year Weed Barrier®

Ideal for short-term weed control for annual plantings. This polypropylene product consists of layers that are laminated and spun-bonded for added strength and extra light blockage.



Item #	Desc	UPC	Vendor	CS/UOS	Location
80010825	4'x100'	042579824342	DWB154100	12/12	National

12 Year Weed Barrier®

Its unique design provides several advantages over conventional weed barrier products. It is fabricated using a spunbond method, which sandwiches melt-blown material between two layers of spun material, forming a powerful 3-ply layer of weed protection.



Item #	Desc	UPC	Vendor	CS/UOS	Location
80010163	6' X 300'	042579633760	12 YR-6300	1/1	National

Typar Premium

TYPAR® Premium Landscape Fabric blocks weeds around plants; unlike plastic, lets moisture, nutrients and air pass through, and is guaranteed to last for 15 years with proper installation and maintenance.



Item #	Desc	UPC	Vendor	CS/UOS	Location
80010078	1.9oz 3'x25'	039526381775	3201C-501W	30/30	National
80010046	1.9oz 3'x50'	039526381690	3201C-502W	20/20	East

15 year Weed Barrier

Standard Weed Control 1.5 oz. pointbond landscape fabric is great for economical or light/medium duty landscape applications. DeWitt Standard Weed Control stops weeds without chemicals and lets air, water and nutrients pass through.



Item #	Desc	UPC	Vendor	CS/UOS	Location
80010824	3'x50'	042579824328	DWB15350	20/20	National
80010822	3'x100'	042579824335	DWB153100	12/12	National
80010827	4'x300'	042579824380	DWB154300	1/1	National
80010828	6'x300'	042579824397	DWB156300	1/1	National

Weed Barrier Pro Black

Designed specifically for professional landscapers, contractors and garden centers, DeWitt Weed-Barrier® Pro is available in black and brown. There's a color to fit every mulch or stone application. Specifically made as a landscape and garden fabric, DeWitt Weed-Barrier® Pro is UV and hydrophilic treated for water permeability.



Item #	Desc	UPC	Vendor	CS/UOS	Location
80010028	6' X 300'	042579816071	PRO BLK-6300	1/1	National
80010470	12' X 300'	042579823703	PRO BLK-12300F	1/1	National

11 Gauge Anchoring Pins

U-shaped steel pins that are angled at their ends for quicker and easier installation by piercing the fabric and penetrating the soil with hand pressure. 6" long x 1" wide.



Item #	Desc	UPC	Vendor	CS/UOS	Location
80010011	P/1000	042579816194	APB1	1000/1000	National
80010058	P/500	042579115006	APB5	500/500	National
80010010	P/48	042579123483	APRC	48/48	National



Natural Burlap

Natural burlap is ideal for soil erosion control, plant protection, wind screen, and tree wraps. Made of jute carpet backing cloth. Medium-weave burlap is the biodegradable. Oil contents 6%; moisture regain 16%. An environmentally friendlier alternative to synthetic burlap.



Item #	Desc	UPC	Vendor	CS/UOS	Location
80010004	3' x 12'	042579431205	NB312	30/30	National
80010005	3' x 24'	042579432400	NB324	20/20	National
80010006	3' x 250' Bulk	042579430031	NB3	1/1	National

Shade Tarp

Can be used for many applications including shading people, plants, pets, and greenhouse shading.

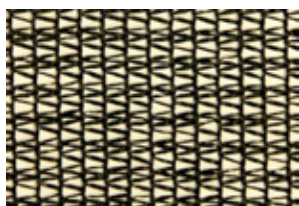

Item #	Desc	UPC	Vendor	CS/UOS	Location
80010602	10'x10'	042579819652	STK60G1010TG2	1/1	National
80010603	10'x20'	042579819669	STK60G1012TG2	1/1	National

Bird And Pond Netting

Bird Barricade is an environmentally safe mesh netting constructed of polypropylene strands and has a 3/4" hole opening. Bird Barricade is the humane way to prevent animals from feeding on and harming trees, bushes, flowers and other plants.



Item #	Desc	UPC	Vendor	CS/UOS	Location
80010192	7' X 10'	042579823369	BPN710	28/28	National
80010193	7' X 20'	042579823376	BPN720	14/14	National
80010189	14' X 14'	042579823383	BPN1414	11/11	National
80010190	14' X 45'	042579823390	BPN1445	7/7	National
80010191	28' X 28'	042579823406	BPN2828	7/7	National

Tree Stake Kit

DeWitt Tree Stake Kits are the professional choice for both commercial and residential applications. Each kit includes a unique non-girdling strap, rope, and (3) 15" plastic tree stakes.



Item #	Desc	UPC	Vendor	CS/UOS	Location
80010040	15" stakes	042579123490	RS15	14/14	National

Crop Protection Winter Fabric

This 1.5 oz. fabric is ideal for protecting flowering annuals, bedding plants and vegetables from severe cold and freezing. Temperatures underneath the fabric are warmer than outside conditions.



Item #	Desc	UPC	Vendor	CS/UOS	Location
80010234	6'x50'	042597822256	SUPREME650	16/16	National

Wooden Tree Stake Kit

This kit includes everything needed to support one newly transplanted tree, or any tree that needs protective support from winds and storms. Your tree grows straight and natural. Unique non-girdling strap with brass grommets. 3 easy to drive into ground, pencil-pointed hardwood 32" stakes. 33 ft of safe and easy-to-use professional tree rope.



Item #	Desc	UPC	Vendor	CS/UOS	Location
80010003	Tree Stake Kit	042579130009	PSS	12/12	National

Earth Coiled Edging

Made from 100% recycled plastic.



Item #	Desc	UPC	Vendor	CS/UOS	Location
80010207	60'	022401100882	EAR-60	1/1	National

Pro-5 Weed Barrier®

Pro-5 Weed Barrier One of the industry's best 5 oz. woven, needle punched, polypropylene fabric designed for professional and commercial use. Pro-5 has been approved by leading landscape architects and government agencies. Pro-5 conserves soil moisture, increases plant growth, and prevents unwanted weeds from germinating. Gold stripes located 12" apart make for easy plant alignment.



Item #	Desc	UPC	Vendor	CS/UOS	Location
80010063	3'x250'	042579132508	P3	1/1	National
80010064	4'x250'	042579142507	P4	1/1	National
80010067	5'x250'	042579152506	P5	1/1	National
80010065	6'x250'	042579162505	P6	1/1	National
80010066	8'x250'	042579182503	P8	1/1	National



Aglok & Prolock Chain Ties

Designed for attaching support stakes to trees larger than 2 in. diameter. Chain ties are great for holding plants to trellises, arbors, lattice or other structures. Lightweight and strong, chain ties are made from durable high-density polyethylene and are easy to use over and over again.



Item #	Desc	UPC	Vendor	CS/UOS	Location
80470066	Prolock 1" X 100'	019263261905	2619	10/10	National
80470064	Aglok 1/2" X 150'	019263261707	2617	20/20	National

2024

Jute Twine

Secure plants, designate rows in a garden or use for gift packages, scrapbooks, cards and more. Spool length is 219'.



Item #	Desc	UPC	Vendor	CS/UOS	Location
80470126	Natural 219 ft.	019263263008	2630	24/24	National
80470127	Green 219 ft.	019263263107	2631	24/24	National

Coated Paper Tree Wrap

Tree wrap protects from insects and heat scold. Easy to use coated paper that will not girdle tree bark.



Item #	Desc	UPC	Vendor	CS/UOS	Location
80470171	3"x50'	050699003035	300303	24/24	National

Treekote Tree Wound Dressing

Tree wound dressing protects your shrubs, bushes, vines, and trees from decay, insects, and fungi. Apply to fresh pruned areas. Shields tree wounds. Withstands all weather: hot, cold, wet, and dry. For patching damaged areas of trees and shrubbery, tree surgery and grafting. Brushtop plastic container.



Item #	Desc	UPC	Vendor	CS/UOS	Location
80470158	16 oz.	050699000164	300016	12/12	National

Tree Stake Kit

Tree stake kit contains 3 notched, pointed hardwood stakes, 3 10" poly straps and 30' of galvanized wire. Everything you need to protect your younger tree from wind and storm damage.



Item #	Desc	UPC	Vendor	CS/UOS	Location
80470060	Tree Stake Kit	019263262100	2621	12/12	National

Garden Hardwood Stakes

Pencil pointed, high-quality 1"x1" stakes from North American hardwoods (Oak, Cherry and Maple) used to support and protect weaker plants or mark separate rows of plants. Banded into bundles for easy handling and retailing. Pricing is based on eaches



Item #	Desc	UPC	Vendor	CS/UOS	Location
80470112	3'x1"x1"	019263255102	2551	25/25	East
80470113	4'x1"x1"	019263255201	2552	25/25	East
80470114	5'x1"x1"	019263255300	2553	25/25	East
80470115	6'x1"x1"	019263255409	2554	25/25	East
80470116	7'x1"x1"	019263255508	2555	25/25	National

GGSPRO TECHNICAL TIPS!

Subscribe to our GGSPRO e-mail program and learn helpful tips and tricks to optimize your growing facility!

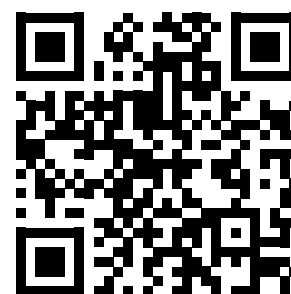

Visit www.griffins.com to subscribe!



Weed Guard Woven Poly Landscape Fabric

9 pack retail ready rolls of weed barrier fabric 3' x 50'

Item #	Desc	UPC	Vendor	CS/UOS	Location
80470010	3'X 50'	019263252804	2528	9/9	National

Medium Weight Burlap Pac

The original packaged burlap in a colorful see-through package. First quality (selvaged both sides), medium-weave, 7 oz. burlap for decorating, crafts, gardening or any other odd jobs around the house. Especially useful for winter protection of valuable evergreen shrubs and bushes.



Item #	Desc	UPC	Vendor	CS/UOS	Location
80470001	3'x9'	019263257502	2575	16/16	National
80470002	3'x12'	019263257601	2576	12/12	National
80470003	3' X 24'	019263257700	2577	9/9	National
80470004	3'x48'	019263257809	2578	5/5	National



RapiClip® Plant Clips

Stretchy material expands with the growth of plant or tree. Convenient ball keeps product wound and secure.

Item #	Desc	UPC	Vendor	CS/UOS	Location
80140200	4MMX100'	035307908681	868	10/10	National

RapiClip® Tomato Clips

Easily clip plants to stakes and wires.



Item #	Desc	UPC	Vendor	CS/UOS	Location
80140013	15 Pack	035307008190	819	12/12	National

RapiClip® Plant Clips

These Twist and Clips will clip plants to canes and wires.



Item #	Desc	UPC	Vendor	CS/UOS	Location
80140067	15 Pack	035307008084	808	12/12	National

RapiClip® Vine & Veggie Trellis Net

Green textile trellis net that provides support to vines and vegetable plants.



Item #	Desc	UPC	Vendor	CS/UOS	Location
80140080	5'x10'	035307008640	864	12/12	National

RapiClip® Plant Twist Tie

Plastic coated wire in holder with cutter.



Item #	Desc	UPC	Vendor	CS/UOS	Location
80140073	100'	035307008411	841	12/12	National
80140076	164'	035307008466	846	12/12	National

Soft Wire Tie Strips

Light duty, pre-cut 8 pieces of multi-purpose PVC/thermoplastic rubber.



Item #	Desc	UPC	Vendor	CS/UOS	Location
80140081	Tie Strips	0353078657	865	12/12	National



RapiClip® Tomato Plant Twine (A)

Natural 2-ply jute. Excellent for supporting tomato plants.

Item #	Desc	UPC	Vendor	CS/UOS	Location
80140018	800'	035307008756	875	12/12	National

RapiClip® Stretchy Nylon Tomato Ties (B)

These Tomato ties are soft, stretchy nylon ties for delicate plants.

Item #	Desc	UPC	Vendor	CS/UOS	Location
80140014	8 Pack	035307008296	829	12/12	National

Foam Wire Tie (C)

RapiClip Foam & Wire Twist Tie - Plant foam wire tie. Ideal for connecting plants and stems to supports. Features 1mm galvanized garden wire wrapped with 7mm foam.

Item #	Desc	UPC	Vendor	CS/UOS	Location
80140070	32.5'	035307008350	835	12/12	East

RapiClip® Vinyl Stretch Tie (D)

Plastic coated wire in holder with cutter.

Item #	Desc	UPC	Vendor	CS/UOS	Location
80140074	1/2" x 150'	035307008442	844	12/12	National
80140075	1" x 150'	035307008459	845	12/12	National

Twine in Dispenser Can

Perfect for dozens of uses around the house and garden. It is great for fastening, training and support in the yard and garden. Suitable for delicate tasks including securing clematis vines to a trellis, and rough tasks such as securing cords and hoses.



Item #	Desc	UPC	Vendor	CS/UOS	Location
80140085	Natural	035307004024	402	12/12	National
80140086	Green	035307004048	404	12/12	National

RapiClip® Plant Twist Ties (E)

0.4mm galvanized wire coated in plastic.

Item #	Desc	UPC	Vendor	CS/UOS	Location
80140077	8" - 100 pk	035307008480	848	12/12	National

RapiClip® Light Duty Garden Wire (F)

Green vinyl coated wire.

Item #	Desc	UPC	Vendor	CS/UOS	Location
80140072	164' Light Duty	035307008381	838	12/12	National

Heavy Duty Garden Wire (G)

Heavy duty garden wire for all yard and garden jobs. 50' roll and carded, with weather-resistant packing.

Item #	Desc	UPC	Vendor	CS/UOS	Location
80140069	50'	035307008343	834	12/12	National

RapiClip® 16' Soft Wire Tie (H)

Multi-purpose cushioned wire tie for countless home and garden uses. Great for supporting saplings and young or recently transplanted trees.

Item #	Desc	UPC	Vendor	CS/UOS	Location
80140163	Brown	035307008596	859	12/12	National
80140015	Green	035307008398	839	12/12	National
80140016	Green Heavy Duty	035307008572	857	12/12	National

RapiClip® Heavy Duty Garden Twine

Heavy duty, 3- ply jute twine for plant support. 200'



Item #	Desc	UPC	Vendor	CS/UOS	Location
80140017	Natural	035307008749	874	12/12	National
80140019	Green	035307008770	877	12/12	National



Double Flower Supports

This double peony flower support is perfect support for peonies. Vinyl coated steel supports.



Item #	Desc	UPC	Vendor	CS/UOS	Location
80140135	18"x36"	035307009784	978	12/12	National

Single Flower Supports

This single peony flower support is perfect support for peonies. Three vinyl coated steel support legs.



Item #	Desc	UPC	Vendor	CS/UOS	Location
80140203	10"x18"	035307009678	967	12/12	National
80140134	14"x24"	00353079777	977	12/12	National
80140141	18"x30"	035307009876	987	12/12	National

Connecting Stakes

Plant Supports offer a full range of vinyl-coated items to keep almost any plant protected within bounds. 13"x30".



Item #	Desc	UPC	Vendor	CS/UOS	Location
80140121	3 Pack	035307009142	914	12/12	East

Link-Ups U-Support

Prop-Ups. For use with annuals or perennials. Helps protect from wind or rain damage. May be used season after season. Great for single stem or bushy plants.



Item #	Desc	UPC	Vendor	CS/UOS	Location
80140144	4"x15"	035307010209	1020	12/12	National
80140145	6"x17"	035307010254	1025	12/12	National
80140146	8"x22"	035307010308	1030	24/24	National
80140147	10"x30"	035307010353	1035	24/24	National
80140148	12"x34"	035307010407	1040	24/24	National
80140149	15"x30"	035307010452	1045	24/24	National
80140150	16"x40"	035307010506	1050	24/24	National

Garden Twine

Jute Twine products from Rapiclip offer a natural, biodegradable and compostable option for tying up plants, or anything around the home.



Item #	Desc	UPC	Vendor	CS/UOS	Location
80140088	400' Green Twine	035307008787	878	12/12	National

Gathering Rings

This gathering ring is easy to open and close to accept one or more taller stems. Vinyl coated steel.



Item #	Desc	UPC	Vendor	CS/UOS	Location
80140123	6"x36"	035307009166	916	24/24	National

Round Grow Through Grids

Keep almost any plant protected and within bounds. Vinyl coated.



Item #	Desc	UPC	Vendor	CS/UOS	Location
80140128	12"x18"	035307009715	971	12/12	National
80140129	16"x24"	035307009722	972	12/12	National
80140130	20"x30"	035307009739	973	12/12	National

Flower Support & Plant Props

Help to support your flower garden stems with these vinyl coated steel plant stakes.



Item #	Desc	UPC	Vendor	CS/UOS	Location
80140136	2"x24"	035307009791	979	72/72	National
80140137	2"x36"	035307009807	980	48/48	National
80140140	3"x44"	035307009852	985	24/24	National

Mossify™

Heart Metal Trellis

Our “Give Love” Heart Metal Trellis is the perfect gift for the plant lover in your life. It's not just a functional piece for their favourite plants, but also a token of your love and affection. The delicate design makes it a beautiful display for any room. Use our metal trellis to add different levels to your plant! Perfect support for climbing plants, vining plants or trailing plants!



Item #	Desc	UPC	Vendor	CS/UOS	Location
82370044	11.75" x 18"	660111996977	MTRLS-B-HRT-001	12/12	National

Reusable Plant Tape

Mossify Plant Tape is the ideal solution for gently securing and training your plants as they grow with their Bendable Moss Poles or Bendable Coir Poles. This innovative and versatile plant tape is designed to blend seamlessly with your indoor garden, featuring a subtle green color that won't detract from the beauty of your plants.



Item #	Desc	UPC	Vendor	CS/UOS	Location
82370008	10'	639114714802	PLNTTP-0010	12/12	National



The Bendable Moss Pole™

The Original Bendable Moss Pole™ by Mossify is a groundbreaking and award-winning moss pole that's revolutionizing the way customers support the growth of their tropical plants. Unlike traditional, rigid moss poles that dictate the direction of your plant's growth, Mossify's Bendable Moss Pole™ is designed to be flexible and adaptable, allowing plants to grow at their own natural pace and in any direction they please.

Item #	Desc	UPC	Vendor	CS/UOS	Location
82370057	16" Thin	660111997318	BMPN-3016	12/12	National
82370058	30" Thin	660111997325	BMPN-3030	12/12	National
82370002	30"	716252512269	BMP-0030	12/12	National
82370059	42" Thin	660111997332	BMPN-3042	12/12	National
82370003	42"	716252512276	BMP-0042	12/12	National

Bendable Coir Pole™

This unique plant support system is just what tropical plants have been craving for. Handcrafted with premium Manila rope, our Bendable Coir Pole™ is not only flexible and easy to use, but it's also perfect for all climbing, vining, and trailing plants. What sets our Bendable Coir Pole™ apart from the Bendable Moss Pole™ is that it's thinner and more pliable, making it the perfect support for a wide variety of plant sizes and shapes.



Item #	Desc	UPC	Vendor	CS/UOS	Location
82370004	16"	676307771082	BCP-0016	12/12	National
82370005	30"	676307771099	BCP-0030	12/12	National
82370006	42"	676307771105	BCP-0042	12/12	National



Tropical Squares Wooden Trellis

The Tropical Squares Wooden Trellis is crafted from high-quality Canadian Maple wood to ensure durability and longevity while maintaining a minimalist look. This fashionable trellis not only supports your plants but also adds a touch of sophistication to your indoor garden, enhancing the overall aesthetic of your space.

Item #	Desc	UPC	Vendor	CS/UOS	Location
82370012	Natural	639114714819	WTRLS-N-TS-0001	12/12	National
82370013	Black	639114714826	WTRLS-B-TS-0001	12/12	National
82370014	White	639114714833	WTRLS-W-TS-0001	12/12	National
82370015	Gold	639114714840	WTRLS-G-TS-0001	12/12	National



Totem Pole Plant Support

The ideal support for all indoor climbing plants. The frame is constructed of heavy gauge steel wire for ease in placing in existing potted plants with no damage to plant roots. Completely assembled; ready to use. The nylon sock is filled with long-fibered sphagnum moss allowing this unique pole to be moistened to encourage plants to cling to the pole. Seven fastening pins are included to assist fastening plants.

Item #	Desc	UPC	Vendor	CS/UOS	Location
80130056	24"	010367010109	ML1010	12/12	East
80130067	24"	010367010109	ML1010 12 DISPLAY	12/12	East
80130057	30"	010367010208	ML1020	12/12	East



Black Plant Stand

Indoors, the plant stands bring harmony and simple elegance to any living room, entry hall, office, or bedroom. Outdoors, they add eye-catching charm to a front porch, patio, back deck, or garden. Gilbert & Bennett plant stands are available in a wide range of sizes from 15 in. to 30 in. tall. The size ranges are designed to suit a variety of needs or to be grouped together in multiple sizes to add depth to a garden display.

Item #	Desc	UPC	Vendor	CS/UOS	Location
82630027	15"	026546211151	BB3-BULK	9/9	West
82630028	21"	026546211151	BB4-BULK	9/9	West
82630029	30"	026546211304	BB5-BULK	9/9	West

Ultomato Cage

The Ultomato Cage is designed specifically for growing tomato plants and other climbing plants. It's the ULTimate in tomato support! For outdoor garden plot and container garden use.



Item #	Desc	UPC	Vendor	CS/UOS	Location
82630002	Green	099713052918	TMC60GR	10/10	West
82630003	Red	099713052932	TMC60RD	10/10	West

Tomato Twist

This twist is constructed out of solid steel with a powder coated finish for extra durability and rust resistance. It keeps your plant healthy by moving them away from the ground and allowing them to grow up to 5-ft tall. Supports plants without blocking sunlight or rain. Plants will easily adapt to this unique, twisted design, eliminating the need for stake ties.



Item #	Desc	UPC	Vendor	CS/UOS	Location
82630007	Green	099713051966	901267GR6	6/6	West
82630008	Red	099713053632	901267RD6	6/6	West

Green Bamboo Stakes

Each package contains 25 sturdy bamboo stakes. Green color to blend in with your garden. Great for building trellises or teepees for natural climbing plant support.



Item #	Desc	UPC	Vendor	CS/UOS	Location
82630021	2 ft. 4-6mm	048307210029	BB2	20/20	West
82630022	3 ft. 6-8mm	048307210036	BB3	20/20	West
82630023	4 ft. 6-8mm	048307210043	BB4	20/20	West
82630025	5 ft. 10-12mm	099713059047	BB5GHD	20/20	West
82630026	6 ft. 12-14mm	099713059054	BB6GHD	20/20	West



Fixed Stake Arms

Green plastic stake arms are designed for use with Ultomato or sturdy stakes of any size. Provides additional support to your Ultomato tomato cage. You can use to grow the cage as your plant grows.

Item #	Desc	UPC	Vendor	CS/UOS	Location
82630006	3 pack	048307118127	SA12	12/12	West

Expandable Stake Arms

Expandable Stake Arms are for use with the Ultomato, Stake it Easy or Sturdy Stakes of any size. Provides additional support to your Ultomato Tomato cage. Grow the cage as your plant grows.



Item #	Desc	UPC	Vendor	CS/UOS	Location
82630005	3 pack	048307118103	SAEXP10-14	12/12	West

Sturdy Stakes

Rustproof and plastic coated for watertight protection, steel core for strength. Spurs prevent slippage.



Item #	Desc	UPC	Vendor	CS/UOS	Location
82630009	2 ft.	048307700025	ST2	25/25	West
82630010	3 ft.	048307700032	ST3	25/25	West
82630011	4 ft.	048307700049	ST4-WS	25/25	West
82630012	5 ft.	048307700056	ST5	25/25	West
82630014	6 ft.	048307700650	ST6HD	10/10	West

Natural Bamboo Stakes

Natural Finish. Used for indoors or outdoors. Strong and durable.



Item #	Desc	UPC	Vendor	CS/UOS	Location
82630017	3 ft. 12 pk	099713056336	BB3N	20/20	West
82630018	4 ft. 12 pk	099713056343	BB4N	20/20	West
82630019	5 ft. 6 pk	099713056350	BB5N	20/20	West
82630020	6 ft. 6 pk	099713056367	BB6N	20/20	West



Gardening Training Wire

Light duty waterproof coated wire for training, and securing branches & vines.

Item #	Desc	UPC	Vendor	CS/UOS	Location
80340314	50'	034613003332	333	12/12	East

Twist Tie Dispenser with Cutter

Ideal for tying plants, vegetables, vines and more. The Bond Twist Tie Dispenser contains plastic coated metal wire that can be cut to any length using the built-in cutter. Colored green to blend with foliage.



Item #	Desc	UPC	Vendor	CS/UOS	Location
80340350	66'	034613011603	1160	10/10	East

U Pins

Secures fabric firmly to the ground. Constructed from steel with zinc coating to combat corrosion. 10 pins per individual pack.



Item #	Desc	UPC	Vendor	CS/UOS	Location
80340508	5.9"x1.5"	34613049927	4992BL	12/12	East

Tie Tape

Bulk tie tape is used for fastening new growth to plant stakes. Perfect for tomato plants and delicate vines. Easy to use and work with. Endless uses for the garden and home.



Item #	Desc	UPC	Vendor	CS/UOS	Location
80340352	150'x 1/2"	034613011504	1150PDQ	20/20	East

Bulk Hardwood Stakes

Bulk hardwood stakes used for plant support or temporary fencing. Kiln dried fir means hardwood is durable. Sharpened points for ease of placement.



Item #	Desc	UPC	Vendor	CS/UOS	Location
80340029	3'x3/4"	035355093001	9300	25/25	East
80340030	4'x3/4"	035355094008	9400	25/25	East
80340031	5'x3/4"	035355095005	9500	25/25	East
80340034	6'x3/4"	035355096002	9600	25/25	East

Packaged Hardwood Stakes

Kiln dried for straight stakes which provides extra strength. Pencil sharpened. Ideal for trees, shrubs, vines, tomatoes, and vegetables.



Item #	Desc	UPC	Vendor	CS/UOS	Location
80340082	4'x3/4"x3/4"	034613940064	94006	6/6	East
80340083	5'x3/4"x3/4"	034613950063	95006BG	6/6	East

Stake Display

- (50) 4' Bamboo 25CT Bag
- (40) 5' Heavy Bamboo Pack
- (40) 6' Heavy Bamboo Pack
- (50) 4' Bulk Hardwood 3/4"
- (25) 5' Bulk Hardwood 3/4"
- (25) 6' Bulk Hardwood 3/4"
- (20) 3' HD Super Steel
- (20) 4' HD Super Steel
- (20) 5' HD Super Steel
- (20) 5' HD Super Steel
- (1) Display Rack



Item #	Desc	UPC	Vendor	CS/UOS	Location
80341321	311 pc		ORBIT OPEN STOCK KIT	1/1	East

Hardwood Stakes

Larger diameter hardwood stake for extra strength. Kiln dried and pencil sharpened point.



Item #	Desc	UPC	Vendor	CS/UOS	Location
80340804	4'x1"x1"	034613940019	94001	25/25	East
80340806	6'x1"x1"	034613960017	96001BG	25/25	East

Bamboo Teepee Trellis

Teepee trellis is suitable for growing vine crops as well as decorative climbing plants or flowers. Folds for off-season storage. Constructed with aluminum rivets.



Item #	Desc	UPC	Vendor	CS/UOS	Location
80340043	60"	034613000607	TP60	6/6	East

Fiberglass Stake

Secures trees, shrubs, vines, tomatoes, and other vegetable plants. The stake guaranteed to not rot or split, and won't have you worrying about the elements testing the integrity of it. Light weight, and weather proof making it great for indoor and outdoor use.



Item #	Desc	UPC	Vendor	CS/UOS	Location
80340359	4'	034613008313	SFS4	10/10	East

Bamboo Stakes

Green dyed packaged bamboo stakes for staking plants, vines and vegetables. Comes in a retail poly bag. Packed 25 stakes per package.



Item #	Desc	UPC	Vendor	CS/UOS	Location
80340014	3'	035355003253	325	25/25	East

Bamboo Heavy Duty Stakes

Lightweight, long-lasting bamboo is ideal for supports and structures. Ideal for all weather conditions. A naturally beautiful landscape accent.



Item #	Desc	UPC	Vendor	CS/UOS	Location
80340779	5'	035355005400	5-40HD	40/40	East

Bamboo Plant Stakes

These natural bamboo stakes are perfect for vegetable gardening. Supports climbing plants.



Item #	Desc	UPC	Vendor	CS/UOS	Location
80340780	6'	035355006407	6-40HD	40/40	East

Bulk Steel Stakes

These heavy duty super steel stakes provide tons of uses for the garden. A must have item for all vegetable and flower growers. Pointed, ribbed and green in color. Weatherproof.



Item #	Desc	UPC	Vendor	CS/UOS	Location
80340363	2'	035355008029	SS2	20/20	East
80340037	3'	035355008036	SS3	20/20	East
80340038	4'	035355008043	SS4	20/20	East
80340039	5'	035355008050	SS5	20/20	East
80340040	6'	035355008067	SS6	20/20	East
80340042	8'	035355008081	SS8-HD	10/10	East

PANACEA®



42" Tomato Cages

Supports tomato plants, climbing vines, as well as bushy top heavy plants and flowers 42"x14" diameter 3 rings x 3 legs. Available in 4 colors: red, green, yellow, and blue.

Item #	Desc	UPC	Vendor	CS/UOS	Location
80160513	Red	93432897713	89771	50/50	National
80160514	Green	93432897720	89772	50/50	National
80160515	Yellow	93432897737	89773	50/50	National
80160516	Blue	93432897744	89774	50/50	National

2024

Double Peony Ring

Has 3 Legs, 2 Rings, 18" Top Ring x 30" High. Galvanized wire construction.

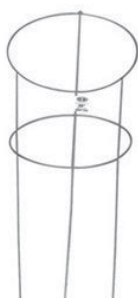

Item #	Desc	UPC	Vendor	CS/UOS	Location
80160063	18"	093432897201	89720	25/25	National

Tomato Cages

Galvanized wire construction. Cages are PVC coated. Great for supporting peppers, eggplants and other tall garden and flowering plants too!



Item #	Desc	UPC	Vendor	CS/UOS	Location
80160064	33"x12"	093432897232	89723	25/25	National
80160065	42"x12"	093432897249	89724	25/25	National
80160066	54" 4 Leg	093432897263	89726	25/25	National
80160530	54" 4 Leg Heavy Duty	093432897393	89739	20/20	National
80160524	54" 3 Leg	093432897256	89725	25/25	National

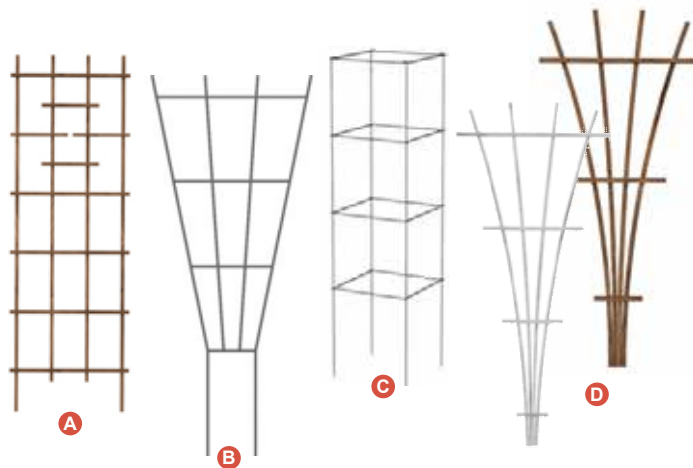

Wooden Ladder Trellis (A)

100% Wood. Available in brown and white.

Item #	Desc	UPC	Vendor	CS/UOS	Location
80161246	Brown 72"	093432824269	82426	6/6	East
80161248	White 72"	093432837368	83736	6/6	East

Green Fan Pot Trellis (B)

This trellis plant support spreads outward from a narrow base as it extends upward to a height of 36". Perfect for small climbing plants and use within a pot of 5" diameter or more.

Item #	Desc	UPC	Vendor	CS/UOS	Location
80160444	36"	093432896358	89635	12/12	East

Square Tomato Tower (C)

Tomato plants and other tall top heavy plants will thrive on this durable plant support tower. Just unfold and create a square frame and push the four stabilizing legs into the ground. Cage can be installed after plant is mature.

Item #	Desc	UPC	Vendor	CS/UOS	Location
80160067	46"	093432897300	89730	25/25	National

Wooden Fan Trellis (D)

100% Wood. Available in brown and white. Two sizes.

Item #	Desc	UPC	Vendor	CS/UOS	Location
80161249	Brown 48"	093432837375	83737	6/6	East
80161245	Brown 72"	093432824252	82425	6/6	East
80161247	White 72"	093432837351	83735	6/6	East

Plant Support

PVC coated Galvanized wire construction. Green - 2" ring, 36" Leg. Train the leaves or stem to twist around the stake for added effect and support.

Item #	Desc	UPC	Vendor	CS/UOS	Location
80160043	36"	093432893401	89340	24/24	National





Metal Plant Stake

Plastic coated metal plant stake (11mm dia.) Green

Item #	Desc	UPC	Vendor	CS/UOS	Location
80160479	3'x11mm	093432897867	89786	50/50	National
80160480	5'x11mm	093432897874	89787	50/50	National
80160481	6'x11mm	093432897881	89788	50/50	National



Moss Poles

Moss Pole is a naturally absorbent support pole that helps aerial roots take hold and creates an ideal habitat for many climbing and upright plants. It's the next best thing to growing your plants in a forest! The SuperMoss Pole includes metal pins to easily secure the branches and foliage.



Item #	Desc	UPC	Vendor	CS/UOS	Location
80230831	24"	759834222101	22210	12/12	West
80230181	3 feet	759834222354	22235	12/12	West

Moss Stake

An elegant and natural way to support growing plants, especially orchids, these sustainable bamboo stakes are covered in the same high-quality green Mountain Moss as our other products. A great way to add natural elements to any potted plant or support top heavy blooms, these stakes come in a fresh green color and are available in a variety of sizes and quantities. Whether you're bringing new life to your living space, enriching your garden for spring, or designing a centerpiece for a special occasion, it all starts with heart.



Item #	Desc	UPC	Vendor	CS/UOS	Location
80230182	18" 6pk	759834220503	22050	8/8	National



Moss Trellis

Item #	Desc	UPC	Vendor	CS/UOS	Location
81510398	12"	038858606297	1297-36-070	36/36	East

Tree Bags 2mm Poly Tube

Prevents broken branches and leaves from falling. Soil stays in the bag to protect interior of customers car. Protects plants from the cold and wind, and protects trees during transportation. Cut to size of the tree. Polyethylene bags on a roll. Flat: 38", Tube: 24", 2mm thickness. 660' roll length.



Item #	Desc	UPC	Vendor	CS/UOS	Location
81550071	24"x660'	813269017968	998600	1/1	East



Hortonova Trellis Net

Tenax Hortonova Trellis Net is the most effective and economical way to support climbing vegetables and heavy crops. The net is a resistant but lightweight stretchable trellis between and over gardens, flower beds or hydroponic systems.



Item #	Desc	UPC	Vendor	CS/UOS	Location
81900105	79"x1500' white	010515403197	1A140319	1/1	East
81900089	79"x1000' white 5.9"x6.7" mesh	010515502838	1A150283	1/1	East
81900112	120"x1500' white 5.9"x6.7" mesh	010515703105	1A170310	1/1	East
81900113	120"x3280' white 5.9"x6.7" mesh	010515703112	1A170311	1/1	East
81900079	59"x3280' white 5.9"x6.7" mesh	010515125105	58012510US	1/1	East
81900090	79"x3280' white 5.9"x6.7" mesh	010515125136	58012513US	1/1	East
81900298	79"x3280' white 4"x4" mesh	010515200222	2A220022	1/1	East
81900065	36" x 3280' white 5.9"x5.9" mesh	010515366072	58036607US	1/1	East
81900076	48"x3280' white 5.9"x5.9" mesh	010515366096	58036609US	1/1	East
81900104	48"x1500' white 5.9"x5.9" mesh	010515403180	1A140318	1/1	East
81900081	67"x3280' white 5.9"x6.7" mesh	010515125112	58012511US	1/1	East



Plastic Bamboo Trellis

This plastic trellis accents plants with its natural bamboo look. Designed to insert into potted soil. As the plant grows, roots grip onto the trellis base making it secure enough to be lifted by the top of the trellis for easy transport.



Item #	Desc	Vendor	CS/UOS	Location
82060088	28-3/4"	PS16	50/50	National
82060089	21-1/2"	PS17	50/50	National

Green Tripod

Economically designed with flexible legs to easily insert into soil to form a growing pyramid for vining plants. As the plant grows, it naturally secures itself to small, fine protrusions on the three legs. Top of the tripod features a lug to clip on a label and is soft enough to prevent eye injury.



Item #	Desc	Vendor	CS/UOS	Location
82060092	18"	TR18	50/50	National
82060093	24"	TR24	50/50	National
82060094	32"	TR32	50/50	National

Black Obelisk

Made to look like wrought iron. These obelisks have hook type grips on the bottom of their legs to achieve a secure hold in soil. Steps up the legs allow climbers to attach easily. Two pieces snap easily together.



Item #	Desc	Vendor	CS/UOS	Location
82060090	32"	OB2	25/25	National

In-Pot Cane Support

An economical way to reduce the mess and create more saleable items. Cane Supports are designed to grip and hold canes upright and steady in pots, helping to prevent damage to plants. Once the plant is rooted, the pot may be lifted by cane for transport.



Item #	Desc	Vendor	CS/UOS	Location
82060084	In-Pot Cane	CBS1	100/100	National

Gro Triangle

Designed to hold three canes upright, creating a column. Sized for split or standard canes.



Item #	Desc	Vendor	CS/UOS	Location
82060081	Triangle Support	GRO-T2	100/100	East

WORLD SOURCE PARTNERS

20" Grow Through Hoops

Grow Through Hoops are suitable for long plants to grow up and through. Made of durable, rust proof plastic coated steel.



Item #	Desc	UPC	Vendor	CS/UOS	Location
81730098	3 legs	745487007554	R755	10/10	East

Split Bamboo Fencing

Use as a boundary fence - create a private area within a garden or over an arbor or pergola. Durable and easy to install.

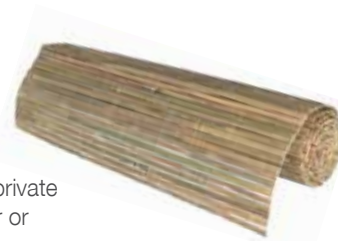

Item #	Desc	UPC	Vendor	CS/UOS	Location
81730296	13'x3'.3"	745487006465	R646HG	1/1	East
81730297	13'x5'	745487006472	R647HG	1/1	East

POTS & PLANTERS

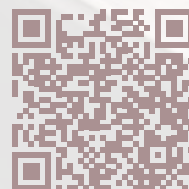

CHECK OUT OUR
CLEARANCE ITEMS!

DROP SHIP VENDORS

Classic Home & Garden

Contact your Griffin Sales Representative for a quote! FOB CT

Blue Sky Clayworks

\$300 min/\$100 re-order per shipping location
FOB Ontario, CA
Cannot mix product from different vendor catalogs to meet
min Offer free goods to help off set cost of freight

Jackson Pottery

\$2,500 min
Freight \$ 850.00 flat rate
Order at jacksonpottery.com



Griffin Greenhouse Retail WAREHOUSE Shipping Map

We are now shipping nationwide!

NATIONAL



2024

Refer to location key:

National items are stocked nationally
 Select items are sold East or West only; no exceptions

8" Kaleidoscope Planter

Premium plastic modular planter can be displayed individually each planter has a removable saucer ideal for succulents or shallow rooted planted.

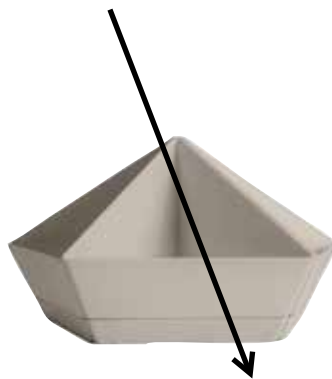

Item #	Desc	UPC	Vendor	CS/UOS	Location
80282643	Vanilla Bisque	770932844170	KDP08000A58	6/6	National

Where is the pricing?

1. Scan QR code on Chapter Pages to see pricing on Griffins.com
2. Contact your Griffin Sales Representative
3. Call into Griffin Customer Service 800.888.0054





Assorted Mini Air Planter

A unique and modern way to add foliage to any home or office, these planters are made from high quality ceramic and designed for ample air circulation. Great for both indoor and outdoor use. 2.5" x 2.5"
Air Plants not included



Item #	Desc	UPC	Vendor	CS/UOS	Location
80690131	Black, White, Red	849637000379	AP07	15/15	East

Cone Air Planters

These cone-shaped hanging planters are a unique and stylish way to showcase your air plants, succulents, or cactus. Use the included metal wire to hang the planter from trees, brackets, or windows. They also make great bird feeders or can be used as tabletop décor. Designed using high-quality ceramic for indoor or outdoor use.
Succulents not included



Item #	Desc	UPC	Vendor	CS/UOS	Location
80690870	Black	849637002946	AP05B	8/8	East
80690871	White	849637002953	AP05GW	8/8	East

Garden Bowl

Great for succulents, herbs, fairy gardens, and creative arrangements, these are attractive, eco-friendly containers made of recycled plastic, stone powder, and wood dust. Lightweight, durable, and weather resistant. Easy to drill for drainage. For indoor or outdoor use.



Item #	Desc	UPC	Vendor	CS/UOS	Location
80690368	8" Choc.	849637000560	M20C	12/12	East

Dragonfly Pot

The unique design of this dragonfly pot makes it a great decorative element. The durable, lightweight planter is made from a unique blend of recycled plastic, stone powder, and wood dust. Easy to drill for drainage. For indoor or outdoor use. Measures 13" x 11".



Item #	Desc	UPC	Vendor	CS/UOS	Location
80690420	Beige	897378002206	OF33B	6/6	East
80690422	Terra Cotta	813001010004	OF33TC	6/6	East

Solstice Round Hanging Basket

A part of our long-established Solstice Series collection for coconut planters, this hanging planter is a sure way to add style to your outdoor green space. The planter is weather-resistant and made from durable metal with a power-coated finish. It includes a secured coconut liner made from 100% natural coconut fibers. The liner helps retain moisture for promoting root growth while also providing sufficient drainage and air circulation.



Item #	Desc	UPC	Vendor	CS/UOS	Location
80690091	20"	813001015931	1593	5/5	East

Coco Liner

Made of natural coconut fiber, these liners retain moisture to promote root growth while providing sufficient drainage and air circulation.



Item #	Desc	UPC	Vendor	CS/UOS	Location
80690057	12" Round	813001015474	1547	15/15	East
80690058	14" Round	813001015481	1548	15/15	East
80690052	24" Trough	813001015405	1540	10/10	East
80690614	18" Round	849637000997	CB54	5/5	East
80690059	16" Round	813001015498	1549	15/15	East
80690060	20" Round	813001015542	1554	5/5	East



Plant Saucer

Made of recycled plastic, stone powder, and wood dust, position these attractive saucers under a planter or garden pot to catch excess water and protect your surfaces. For indoor or outdoor use.

Item #	Desc	UPC	Vendor	CS/UOS	Location
80690134	10" Chocolate	813001013074	AP25C	4/4	East
80690135	10" Dark Charcoal	813001013050	AP25DC	4/4	East
80690136	10" Terra Cotta	813001013043	AP25TC	4/4	East
80690138	12" Chocolate	813001013036	AP30C	4/4	East
80690139	12" Dark Charcoal	813001013012	AP30DC	4/4	East
80690140	12" Terra Cotta	813001013005	AP30TC	4/4	East
80690143	14" Dark Charcoal	813001012978	AP35DC	4/4	East
80690144	14" Terra Cotta	813001012961	AP35TC	4/4	East



Deluxe Pedestal Urn

Arcadia Garden Products' Deluxe Pedestal Urns make a bold statement with a timeless, classic design. These plastic urns are an ideal statement piece for any entryway, living space, patio, or garden. Made of high-quality plastic material, the urns can compete against weather and UV-rays while still easy to relocate.



Item #	Desc	UPC	Vendor	CS/UOS	Location
80690838	10x17" Black	849637007064	PL50BK	2/2	East
80690839	10x17" White	849637007071	PL50WT	2/2	East
80690842	22x36" Black	846937007101	PL52BK	2/2	East

Traditional Whitewash Plastic Urn

Featuring a traditional design, these plastic urns are an ideal statement piece for any entrance way, living space, table centerpiece, or garden. The high-quality synthetic material creates a sturdy product that can compete against weather and UV-rays. The two-piece pedestal construction is a classic design that adds style to any décor.



Item #	Desc	UPC	Vendor	CS/UOS	Location
80690905	10x12"	849637006289	PL20WW	18/18	East
80690904	13x15"	849637006272	PL10WW	16/16	East
80690903	16x18"	849637006265	PL00WW	12/12	East

Bulb Pans

Ideal for daffodils, tulips, succulents, bonsai, and fairy gardens, these are attractive, eco-friendly containers made of recycled plastic, stone powder, and wood dust. Lightweight, durable, and weather resistant. Easy to drill for drainage. For indoor or outdoor use.



Item #	Desc	UPC	Vendor	CS/UOS	Location
80690720	A 10"x5" Taupe	849637004216	TD25TP	12/12	East
80690717	B 8"x3" Taupe	849637004278	TA20TP	12/12	East
80690718	B 10"x3.5" Taupe	849637004285	TA25TP	12/12	East
80690719	B 12"x5" Taupe	849637004292	TA30TP	12/12	East
80690466	8"x3" Dark Charcoal	813001010479	TA20DC	12/12	East
80690517	12"x5" Dark Charcoal	813001010530	TA30DC	12/12	East
80690467	8"x3" Terra Cotta	813001010486	TA20TC	12/12	East
80690518	12"x5" Terra Cotta	813001010547	TA30TC	12/12	East



bloem

Grecian Urn

A perfect transition from classic Greece to America's Garden Scene. The Grecian series combines the natural look of stone with the durability and economy of polypropylene. Perfect on a patio, porch or deck.



Item #	Desc	UPC	Vendor	CS/UOS	Location
80920755	12" Black	811214020445	GU12-00	12/12	National
80921956	12" Charcoal	814174029756	GU12-908	12/12	National
80920761	18" Black	811214020506	GU18-00	6/6	National
80921958	18" Casper White	814174029763	GU18-09	6/6	National
80921960	18" Charcoal	814174029770	GU18-908	6/6	National

Grecian Pedestal Urn

Quality urn made of polypropylene. 100% UV stable and weather resistant. Safe to leave out all winter long and will hold up for many years in the strongest sun. Measures 32" tall and 18" diam.



Item #	Desc	UPC	Vendor	CS/UOS	Location
80920767	18" Black	811214020568	GU180-00	4/4	National
80921957	18" Casper White	814174029787	GU180-09	4/4	National
80921959	18" Charcoal	814174029794	GU180-908	4/4	National

Dayton Planters

Eco-friendly and enduring outdoor planter. Ocean Series planters are made of 100% recycled material, and sourced from recycled ocean plastic. They are blended with post consumer recyclables to create a stable resin and achieve color varieties. BPA-free, fade resistant, and long lasting. Includes drainage holes and an attached saucer.



Item #	Desc	UPC	Vendor	CS/UOS	Location
80922193	15" Square Turtle Green	087404003714	DAYSQ1555	10/10	East
80922194	15" Square Ocean Blue	087404003721	DAYSQ1571	10/10	East
80922195	27" Window Box Turtle Green	087404003738	DAYDB2755	10/10	East



BLOEM COLOR KEY



Living Green



Chocolate



Terra Cotta



Charcoal



Merlot



Burnt Red



Misty Blue



Pebble Stone



Muted Terra Cotta

bloem

ARIANA PLANTER

Bell-shaped decorative planters |

With grid - For worry free watering

A self-watering insert built into the bottom of the planter traps excess water where the roots can access it, reducing the how often you need to water. It also helps prevent plant-killing root rot by allowing oxygen to access the plants roots. A range of traditional and vibrant color choices make it easy to coordinate with your home décor or add an eye-catching splash of color.



6" Ariana Planters

Item #	Desc	UPC	Vendor	CS/UOS	Location
80921362	6" Living Green	087404564062	20-56406	10/10	National
80921364	6" Chocolate	087404563065	20-56306CH	10/10	National
80921363	6" Terra Cotta	087404561061	20-56106	10/10	National
80921869	6" Charcoal	814174029602	AP06908	10/10	National
80922249	6" Merlot	087404004346	AP0657	10/10	National
80921866	6" Burnt Red	814174029305	AP0613	10/10	National
80922250	6" Pebble Stone	087404004384	AP0683	10/10	National
80922248	6" Muted Terra Cotta	087404004933	AP0647	10/10	National
80921354	6" Black	087404569067	20-56906	10/10	National
80922247	6" Misty Blue	087404004308	AP0637	10/10	East

8" Ariana Planters

Item #	Desc	UPC	Vendor	CS/UOS	Location
80921374	8" Living Green	087404564086	20-56408	10/10	National
80921376	8" Chocolate	087404563089	20-56308CH	10/10	National
80921375	8" Terra Cotta	087404561085	20-56108	10/10	National
80921870	8" Burnt Red	814174029336	AP0813	10/10	National
80921873	8" Charcoal	814174029619	AP08908	10/10	National
80922253	8" Merlot	087404004353	AP0857	10/10	National
80922254	8" Pebble Stone	087404004391	AP0883	10/10	National
80922252	8" Muted Terra Cotta	087404004940	AP0847	10/10	National
80921366	8" Black	087404569081	20-56908	10/10	National
80922251	8" Misty Blue	087404004315	AP0837	10/10	East



10" Ariana Planters

Item #	Desc	UPC	Vendor	CS/UOS	Location
80921386	10" Living Green	087404564109	20-56410	10/10	National
80921388	10" Chocolate	087404563102	20-56310CH	10/10	National
80921387	10" Terra Cotta	087404561108	20-56110	10/10	National
80921874	10" Burnt Red	814174029367	AP1013	10/10	National
80921877	10" Charcoal	814174029626	AP10908	10/10	National
80922257	10" Merlot	087404004360	AP1057	10/10	National
80922258	10" Pebble Stone	087404004407	AP1083	10/10	National
80922256	10" Muted Terra Cotta	087404004957	AP1047	10/10	National
80921378	10" Black	087404569104	20-56910	10/10	National
80922255	10" Misty Blue	087404004322	AP1037	10/10	East

12" Ariana Planters

Item #	Desc	UPC	Vendor	CS/UOS	Location
80921398	12" Living Green	087404564123	20-56412	10/10	National
80921400	12" Chocolate	087404563126	20-56312CH	10/10	National
80921399	12" Terra Cotta	087404561122	20-56112	10/10	National
80921878	12" Burnt Red	814174029398	AP1213	10/10	National
80922261	12" Merlot	087404004377	AP1257	10/10	National
80921881	12" Charcoal	814174029633	AP12908	10/10	National
80922262	12" Pebble Stone	087404004414	AP1283	10/10	National
80922260	12" Muted Terra Cotta	087404004964	AP1247	10/10	National
80921390	12" Black	087404569128	20-56912	10/10	National

16" & 20" Ariana Planters

Item #	Desc	UPC	Vendor	CS/UOS	Location
80921410	16" Living Green	087404564161	20-56416	6/6	National
80921412	16" Chocolate	087404563164	20-56316CH	6/6	National
80921411	16" Terra Cotta	087404561160	20-56116	6/6	National
80921422	20" Living Green	087404564208	20-56420	6/6	National
80921424	20" Chocolate	087404563201	20-56320CH	6/6	National
80921423	20" Terra Cotta	087404561207	20-56120	6/6	National



BLOEM COLOR KEY



Terra Cotta



Pebble Stone



Charcoal



Black



Living Green



Muted Terra Cotta



Misty Blue



Casper White



Chocolate

bloem

Dura Cotta Window Box

Made from durable polypropylene. Plastic outdoor planters offer affordable beauty without heavy weight or risk of breakage.

Window box includes attached drainage tray and cross support piece.



Item #	Desc	UPC	Vendor	CS/UOS	Location
80920719	18" Terra Cotta	811214020087	DCBT18-46	12/12	National
80921932	18" Charcoal	087404000348	DCBT18-908	12/12	National
80920718	18" Living Green	811214020070	DCBT18-42	12/12	National
80921527	18" Chocolate	814174024355	DCBT18-45	12/12	National
80920724	18" Black	811214020131	DCBT18-00	12/12	East
80920725	24" Living Green	811214020148	DCBT24-42	12/12	National
80920726	24" Terra Cotta	811214020155	DCBT24-46	12/12	National
80921934	24" Charcoal	087404000362	DCBT24-908	12/12	National
80920732	30" Living Green	811214020216	DCBT30-42	12/12	National
80920733	30" Terra Cotta	811214020223	DCBT30-46	12/12	National
80921936	30" Charcoal	087404000386	DCBT30-908	12/12	National

Mathers Planters

The Mathers planter was designed to be both simple and sophisticated. This planter is great for indoor and outdoor planting. Planters feature predrilled drainage holes and attached snap on saucer to protect surfaces. Great for foliage and flower drop ins!



Item #	Desc	UPC	Vendor	CS/UOS	Location
80922300	6" Muted Terra Cotta	087404005404	MAT0647	4/4	National
80922299	6" Misty Blue	087404005398	MAT0637	4/4	National
80922301	6" Pebble Stone	087404004483	MAT0683	4/4	National
80922304	8" Muted Terra Cotta	087404005428	MAT0847	4/4	National
80922303	8" Misty Blue	087404004704	MAT0837	4/4	National
80922305	8" Pebble Stone	087404004490	MAT0883	4/4	National
80922308	10" Muted Terra Cotta	087404005435	MAT1047	4/4	National
80922309	10" Pebble Stone	087404004735	MAT1083	4/4	National
80922307	10" Misty Blue	087404004728	MAT1037	4/4	National

Tuxton Planters

This unique geometric garden pot has a strong modern look. Designed to easily just drop-in plantings and works great with succulents and herbs. The pot is made of high-quality durable material which ensures that pot won't fade if placed in the sun. Very clean and resistant to extreme weather. No drainage



Item #	Desc	UPC	Vendor	CS/UOS	Location
80922314	6" Casper White	087404004995	TXT0609	6/6	East
80922315	6" Charcoal	087404005008	TXT06908	6/6	East
80922316	8" Casper White	087404005015	TXT0809	6/6	East
80922317	8" Charcoal	087404005022	TXT08908	6/6	East
80922318	10" Casper White	087404005039	TXT1009	6/6	East
80922319	10" Charcoal	087404005046	TXT10908	6/6	East

Finley Tall Square Planter

Made out of 100% recycled plastic, these planters feature punch out holes to allow water to drain freely and prevent root rot. From front door statements to back deck decor these impress.



Item #	Desc	UPC	Vendor	CS/UOS	Location
80922293	20" Casper White	087404005374	FPS2009-6	6/6	National
80922292	20" Black	087404004285	FPS2000-6	6/6	National
80922330	25" Casper White	087404006074	FPS2509-2	4/4	National
80922329	25" Black	087404006067	FPS2500-2	4/4	National

Finley Tall Round Planter

Made out of 100% recycled plastic, these planters feature punch out holes to allow water to drain freely and prevent root rot. From front door statements to back deck decor these modern and stylish planters are sure to impress.



Item #	Desc	UPC	Vendor	CS/UOS	Location
80922326	14" Black	087404006036	FPR1400	4/4	East
80922327	14" Casper White	087404006043	FPR1409	4/4	East



BLOEM COLOR KEY



Terra Cotta



Charcoal



Black



Living Green



Bermuda Teal



Burnt Red



Earthy Yellow



Classic Blue



Chocolate

bloem



Terrapot Planter & Bowl

Add a touch of color to your garden or home with this charming Bloem Terra Pot Planter. Inspired by the look of clay planters but constructed of a durable polypropylene material, enabling years of functionality and reliable use.

Item #	Desc	UPC	Vendor	CS/UOS	Location
PLANTER					
80921536	4" Terra Cotta	087404500046	20-50004C	20/20	National
80921535	4" Living Green	814174026373	TR0442	20/20	National
80921537	4" Chocolate	814174026380	TR0445	20/20	National
80922104	4" Charcoal	087404000935	TR04908	20/20	National
80921541	6" Terra Cotta	087404500060	50006C	20/20	National
80921540	6" Living Green	087404504068	50406	20/20	National
80921542	6" Chocolate	087404500657	450065-1001	20/20	National
80922107	6" Charcoal	087404000966	TR06908	20/20	National
80921546	8" Terra Cotta	087404500084	50008C	20/20	National
80921545	8" Living Green	087404504082	20-50408	20/20	National
80921547	8" Chocolate	087404500855	450085-1001	20/20	National
80922110	8" Charcoal	087404000997	TR08908	20/20	National
80921551	10" Terra Cotta	087404500107	50010C	20/20	National
80921552	10" Chocolate	087404501050	450105-1001	20/20	National
80922113	10" Charcoal	087404001024	TR10908	20/20	National
80921769	10" Living Green	087404504105	50410	20/20	National
80921556	12" Terra Cotta	087404500121	50012C	10/10	National
80921557	12" Chocolate	087404503122	50312CH	10/10	National
80922116	12" Charcoal	087404001055	TR12908	10/10	National
80921562	14" Chocolate	087404503146	20-50314CH	10/10	National
80921561	14" Terra Cotta	087404500145	50014C	10/10	National
80921566	16" Terra Cotta	087404500169	50016C	10/10	National
80921568	16" Chocolate	087404503160	50316CH	10/10	National
80921571	20" Terra Cotta	087404500206	50020C	10/10	National
BOWL					
80921828	14" Terra Cotta	087404540141	54014C	10/10	East

Saturn Planter

Add a touch of modern elegance to your garden or home with this charming Bloem Saturn planter. It is crafted from polypropylene, so it is durable and can be used both inside or outside no matter the weather. The design features natural textures and decorative embellishments to add a beautiful accent to your home.

Item #	Desc	UPC	Vendor	CS/UOS	Location
80922060	5" Charcoal	814174029459	SP05908	12/12	National
80921306	5" Black	814174023051	SP0500	12/12	National
80922057	5" Bermuda Teal	087404000737	SP0526	12/12	National
80922055	5" Burnt Red	087404000713	SP0513	12/12	National
80922056	5" Earthy Yellow	087404000720	SP0523	12/12	National
80922218	5" Classic Blue	087404003486	SP0533	12/12	National
80922066	7" Charcoal	814174029480	SP07908	12/12	National
80921313	7" Black	814174023105	SP0700	12/12	National
80922063	7" Bermuda Teal	087404000768	SP0726	12/12	National
80922061	7" Burnt Red	087404000744	SP0713	12/12	National
80922062	7" Earthy Yellow	087404000751	SP0723	12/12	National
80922219	7" Classic Blue	087404003493	SP0733	12/12	National
80922072	10" Charcoal	814174029510	SP10908	6/6	National
80921320	10" Black	814174023150	SP1000	6/6	National
80922069	10" Bermuda Teal	087404000799	SP1026	6/6	National
80922067	10" Burnt Red	087404000775	SP1013	6/6	National
80922068	10" Earthy Yellow	087404000782	SP1023	6/6	National
80922220	10" Classic Blue	087404003509	SP1033	6/6	National
80922078	12" Charcoal	814174029541	SP12908	6/6	National
80921327	12" Black	814174023204	SP1200	6/6	National
80922075	12" Bermuda Teal	087404000829	SP1226	6/6	National
80922073	12" Burnt Red	087404000805	SP1213	6/6	National
80922074	12" Earthy Yellow	087404000812	SP1223	6/6	National
80922221	12" Classic Blue	087404003516	SP1233	6/6	National



bloem

Deck Rail Planter

This planter is great for home and apartment use and helps you make the most of your porch or patio living space. Compression design ensures a secure fit on either a 4" or 6" wide rail with drainage holes. Features a tiered bottom design allowing dirt and roots to grow strong and deep.



Item #	Desc	UPC	Vendor	CS/UOS	Location
80921274	12" Terra Cotta	087404771217	477121-1001	10/10	National
80922273	12" Charcoal	087404005367	DR12908	10/10	National
80921276	24" Terra Cotta	087404477249	477241-1001	10/10	National
80921277	24" Chocolate	087404772450	477245-1001	10/10	National
80922242	24" Charcoal	087404003028	DR24908	10/10	National

Finley Rail Planter

Made of 100% recycled plastic. These planters feature punch out holes to allow water to drain freely. Deck rail fits a standard 2x4 or 2x6 railing. 9.5" H x 11.74" W x 23.99" D



Item #	Desc	UPC	Vendor	CS/UOS	Location
80922332	24" Black	087404006098	FDR2400	6/6	National
80922333	24" Casper White	087404006104	FDR2409	6/6	National
80922334	24" Charcoal	087404006111	FDR24909	6/6	East



Rectangular Trough

Plastic lined. 6 sets of 2 per case 11"x4"x3", 11.5"x5.5"x3.5"



Item #	Desc	UPC	Vendor	CS/UOS	Location
801371076	Set of 2	619216026577	2657	6/6	East

Oval Farm Containers

12.5" x 8" x 8.5"
14" x 9" x 9.5"
4 sets of 2 per case



Item #	Desc	UPC	Vendor	CS/UOS	Location
801371069	Set of 2	619216080784	8078	4/4	East



Medium Garden Bowl (A)

Part of the Boutique Collection this bowl is old world charm meets new world elegance in a tres chic selection of subtly designed galvanized containers. Includes plastic liner.

Item #	Desc	UPC	Vendor	CS/UOS	Location
81370128	9"x4"	619216024627	02462	16/16	East

Oblong Garden Trough Set (B)

8 1/2" x 5" x 4 1/2", 10" x 5 1/2" x 5", 11" x 6" x 5".
6 sets of 3 per case, Includes plastic liner

Item #	Desc	UPC	Vendor	CS/UOS	Location
81370126	3 pc.	619216024603	02460	6/6	East

Medium Garden Pail (C)

6 1/2" x 5" includes plastic liner

Item #	Desc	UPC	Vendor	CS/UOS	Location
81370131	6 1/2"x5"	619216024658	02465	16/16	East

Lavender Garden Pails (D)

includes plastic liner. Dimensions: 5" x 5".

Item #	Desc	UPC	Vendor	CS/UOS	Location
81370130	Set of 3	619216024641	02464	16/16	East

Turquoise Oblong Planters

12" x 5.5" x 3.5"
14" x 6.5" x 4"
15.5" 7" x 4.5"
4 sets of 3 per case, each planter includes a plastic liner.



Item #	Desc	UPC	Vendor	CS/UOS	Location
801370861	Set of 3	619216230356	23035	12/12	East

BRAUN

GARDEN PRODUCTS



Seagrass Cone Hanging Basket (A)

Waves of tones and textures artlessly fall over these woven seagrass creations. Built on galvanized frames for enhanced durability. Hanging Basket includes stiff, swivel-chain hangers

Item #	Desc	UPC	Vendor	CS/UOS	Location
81370510	14"	619216262012	26201	20/20	East

Cone Leaf Hanging Basket Planter (B)

14" Nature inspired hanging basket made of natural leaves and rattan. Plastic insert and stiff, swivel-hanger included.

Item #	Desc	UPC	Vendor	CS/UOS	Location
81370553	14"	619216365126	36512	20/20	East

Evergreen Cone Hanging Basket (C)

Item #	Desc	UPC	Vendor	CS/UOS	Location
81370508	12"	619216261183	26118	20/20	East



Antique Mushroom

Galvanized Metal with floral fern prints bring a new edge of design to the mix. Small 6.75" x 6.5" | Medium 9.75" x 6.5" Large 13" x 7.5" 3 sets of 3 per case

Item #	Desc	UPC	Vendor	CS/UOS	Location
81370940	Set of 3	619216023811	2381	3/3	East

Cold Creek

Think of these rustic chic pieces as country with an edge. These galvanized metal planters are NEW! Small 10" x 5.5" | Medium 12" x 6.5" | Large 15" x 7.5" 5 Sets of 3 per case



Item #	Desc	UPC	Vendor	CS/UOS	Location
81370942	Set of 3	619216023899	2389	5/5	East

Boho Pot

Harking back to hand-thrown masterpieces, this artful array ups the interest with a mixed-media approach incorporating stone.



Item #	Desc	UPC	Vendor	CS/UOS	Location
81370956	Small 3 1/2" x 4"	619216004605	460	18/18	East
81370957	Medium 5 1/2" x 5"	619216004612	461	24/24	East

Hanging Basket w/ Mossmat Liner

Growers Essential anything but ordinary Mossmat Hanging basket with galvanized chain.



Item #	Desc	UPC	Vendor	CS/UOS	Location
801370936	12"	619216211133	21113	10/10	East

King Cup Cactus

Harking back to hand-thrown masterpieces, this artful array ups the interest with a mixed-media approach incorporating stone.



Item #	Desc	UPC	Vendor	CS/UOS	Location
81370958	5 1/4" x 4 3/4"	619216004599	459	18/18	East



Tapestry Planter

Ceramic planters glazed with bright and bold patterns. All planters come with drainage holes.

Item #	Desc	UPC	Vendor	CS/UOS	Location
81370831	Blazing Fire Rim Planter	619216082009	08200	24/24	East
81370836	Black Earth Cylinder Planter	619216082047	08204	24/24	East
801371124	Collection Namaste Blue	619216082092	8209	24/24	East



2024



Tapestry Planter (A)

Ceramic planters glazed with bright and bold patterns. All planters come with drainage holes. Round planters 4" x 3 3/4"
Cube planters 3" x 3"

Item #	Desc	UPC	Vendor	CS/UOS	Location
81370834	A Blazing Fire Cylinder	619216082054	8205	24/24	East
81370835	B Blue Sun Cylinder	629216082030	8203	24/24	East
81370838	C Blue Sun Cube	619216082061	8206	24/24	East
81370837	D Blazing Fire Cube	619216082078	8207	24/24	East
801371132	E Matte Mist Cylinder	619216082160	8216	24/24	East
801371126	F Blue Wing Cube	619216082115	8211	24/24	East
801371128	G Sea Green Forest Cylinder	619216082139	8213	24/24	East
801371130	H Longwood Cylinder	619216082146	8214	24/24	East
801371127	I Blue Sky Cube	619216082122	8212	24/24	East



English Bowl (B)

6" x 2.5"

Item #	Desc	UPC	Vendor	CS/UOS	Location
81370755	Small	619216004261	426	18/18	East



Rectangle Box (C)

Part of the Homestead Collection; traditional styling and rustic barn wood make these containers the classic accents every home and garden needs. Plastic lined.

Item #	Desc	UPC	Vendor	CS/UOS	Location
81370138	8 1/2"x5"x4"	619216028038	02803	16/16	East
81370139	7"x5"x4 1/2"	619216028045	02804	16/16	East



Square Box (D)

Part of the Homestead Collection; traditional styling and rustic barn wood make these containers the classic accents every home and garden needs. Plastic lined.

Item #	Desc	UPC	Vendor	CS/UOS	Location
81370136	4 1/2"x4 1/2"x4"	619216028014	02801	16/16	East
81370137	6"x6"x6"	619216028021	02802	16/16	East
81370135	8 1/2"x8 1/2"x5"	619216028007	02800	16/16	East

Galvanized Tray Planters (E)

8 sets of 2 per case | 12" x 6" x 5 1/2" | 15" x 7" x 6"

Item #	Desc	UPC	Vendor	CS/UOS	Location
801370887	8 sets of 2	619216020582	02058	8/8	East

Galvanized Trough Planters (F)

LG- 23" x 6" x 6"

Item #	Desc	UPC	Vendor	CS/UOS	Location
801370889	Large	619216020612	02061	12/12	East



Herb Carrier with 3 Pots (G)

Harkening to hand-thrown masterpieces, this artful array ups the interest with a mixed media approach incorporating stone, wire, wood and metal. 2 sets per case

Item #	Desc	UPC	Vendor	CS/UOS	Location
81370051	16"x16 1/2"x10 1/2"	619216004469	0446	2/2	East

Honeycomb Tall Planters (A)

Made of clays and other naturally-found materials. Frost proof and UV resistant.

9"x9"x18"

12"x12"x24 1/2"

16 1/2" x 16 1/2" x 30 1/2"

3 pieces per set

Item #	Desc	UPC	Vendor	CS/UOS	Location
801370862	3 pc.	619216041136	4113	1/1	East



Pottery Studio Dish Planters (B)

Dimensions: 6" x 2"

Item #	Desc	UPC	Vendor	CS/UOS	Location
81370041	6"	619216004131	00413	24/24	East



Signature Cache Pots (C)

Dimensions: 5" x 4", 6 1/2" x 5"

Item #	Desc	UPC	Vendor	CS/UOS	Location
81370054	Set of 2	619216004513	00451	6/6	East



Eclectic Garden Collection Head Planters (D)

Leon 7.5" x 4.5" - Stacy 6.5" x 5.5" - Ned 9" x 5"

Item #	Desc	UPC	Vendor	CS/UOS	Location
801371119	Leon	619216070716	7071	6/6	East
801371121	Stacy	619216070730	7073	6/6	East
801371120	Ned	619216070723	7072	6/6	East



Square Wooden Box (E)

Dimensions: Large: 8"x4" Medium 7"x4" and includes plastic liner

Item #	Desc	UPC	Vendor	CS/UOS	Location
801371080	Large	619216026720	02672	16/16	East
801371079	Medium	619216026713	02671	16/16	East



Northshore Dish Planter (F)

Lightweight, plastic-lined galvanized metal is long-lasting, while its weathered texture provides authenticity Dimensions: Small 6"x6"x2.5" Medium 8.5" x 3" | Large 11" x 3.5" and includes plastic liner

Item #	Desc	UPC	Vendor	CS/UOS	Location
81370158	Small	619216030246	03024	16/16	East
81370159	Medium	619216030253	03025	16/16	East
81370160	Large	619216030260	03026	16/16	East



Antique Color Hexagon Planter (G)

Classic galvanized metal containers. 4 sets of 3 per case. Small 6.5"x9" Medium 7.5"x10" Large 8"x11.25" Plastic lined

Item #	Desc	UPC	Vendor	CS/UOS	Location
81370810	Set of 3	619216023514	2351	4/4	East

BRAUN
GARDEN PRODUCTS



A



B



C



D



E



F



G



H

Victorian Urn (A)

18" x 22" comes with moss matt liner.

Item #	Desc	UPC	Vendor	CS/UOS	Location
81370099	22"	619216023330	2333	3/3	East

Flat bottom Hanging Basket (B)

14" Nature inspired twisted seagrass hanging basket. Complete with a stiff, swivel chain hanger.

Item #	Desc	UPC	Vendor	CS/UOS	Location
801370906	14"	619216263026	26302	20/20	East

Evergreen Moss Hanging Basket (C)

Sphagnum moss is applied to the outside of a galvanized wire frame for strength and durability to these hanging baskets. Chain included.

Item #	Desc	UPC	Vendor	CS/UOS	Location
81370264	12"	619216211188	21118	20/20	East

Wicker Tear Drop Planter (D)

Dimensions: 9" x 4" x 12"

Item #	Desc	UPC	Vendor	CS/UOS	Location
801370848	12"	619216024221	2422	12/12	East

Wicker Flower Basket (E)

Wicker Flower Basket is ready to plant and features a plastic liner insert. 12" x 7" x 12"

Item #	Desc	UPC	Vendor	CS/UOS	Location
801370837	12"	619216024122	2412	12/12	East

Bust Planter (F)

As part of the Eclectic Garden Boutique Collection these high fashion home and garden planters seamlessly meld in this collection of garden accessories, made for cross selling. Holds a 4" pot, no drainage.

Item #	Desc	UPC	Vendor	CS/UOS	Location
81370216	Cleopatra 10"x9"	619216070518	07051	6/6	East
81370215	Caesar 10"x9"	619216070501	7050	6/6	East

Eclectic Garden Boutique Busts (G)

Easter Island Head 5 1/4" x 4 3/4" x 8" with drainage hole
Greek Goddess 4 1/2"x 5 1/2"x 6 1/2" with drainage hole

Item #	Desc	UPC	Vendor	CS/UOS	Location
81370817	Easter Island Head	619216070693	07069	12/12	East
81370816	Greek Goddess	619216070709	07070	12/12	East

Romeo and Juliet Planters (H)

Romeo 17.5" x 10" x 7" holds 5" pot *no drainage*
Juliet 16" x 9" x 6" holds 5" pot *no drainage*

Item #	Desc	UPC	Vendor	CS/UOS	Location
81370229	Romeo	619216070648	7064	2/2	East
81370230	Juliet	619216070655	7065	2/2	East



Square Drawer Planter (A)

Part of the Homestead Collection; traditional styling and rustic barn wood make these containers the classic accents every home and garden needs. Plastic lined. 8" x 8" x 4"

Item #	Desc	UPC	Vendor	CS/UOS	Location
81370747	Square	619216028175	02817	16/16	East

Triple Drawer Planter (B)

Plastic lined 13" x 4 1/2" x 4"

Item #	Desc	UPC	Vendor	CS/UOS	Location
81370745	3 Drawers	619216028151	02815	16/16	East

Single Drawer Planter (C)

Plastic lined 4 1/2" x 4 1/2" x 4"

Item #	Desc	UPC	Vendor	CS/UOS	Location
81370743	1 Drawer	619216028137	02813	16/16	East

Moss Teddy Bear

Hand crafted mossed topiary frame will make your gardens first impression a lasting one. The frame, constructed of high quality metal and finished in an elegant matt black powder coating to resist the elements is then filled with just the right amount of sphagnum moss and treated with your very own "Moss Green". The Sphagnum Moss is your planting medium. It is the "soil" you will use to plant your topiary. With every frame being hand made and hand filled, this makes each topiary an almost one of a kind sculpture



Item #	Desc	UPC	Vendor	CS/UOS	Location
81370961	11"	619216229251	22925	1/1	East

Long Wooded Trough

Part of the Homestead Collection; traditional styling and rustic barn wood make these containers the classic accents every home and garden needs. Plastic lined. They measure 19" x 10" x 3 1/2", 16 1/2" x 8 1/2" x 3", 13 1/2" x 7 1/4" x 2 1/2". 4 sets of 3 per case



Item #	Desc	UPC	Vendor	CS/UOS	Location
81370145	3 pc.	619216028106	02810	4/4	East

Water Bucket

Part of the Homestead Collection; traditional styling and rustic barn wood make these containers the classic accents every home and garden needs. Plastic lined.



Item #	Desc	UPC	Vendor	CS/UOS	Location
81370140	8" x 7 1/2"	619216028052	02805	16/16	East

Urban Collection Galvanized Tubs

4 sets of 3 per case. 4.25" x 4" | 5" x 5.5" | 6" x 7"



Item #	Desc	UPC	Vendor	CS/UOS	Location
801371118	Set of 3	619216020827	2082	4/4	East

Upright Galvanized Planters

2 sets of 3 per case 8" x 14" | 10" x 16.5" | 12" x 20"



Item #	Desc	UPC	Vendor	CS/UOS	Location
81370946	Set of 3	619216020544	2054	2/2	East

CURTIS WAGNER

PLASTICS

Terracotta Vinyl Heavy Plant Saucer

Protects surfaces from water leaks and stains and is made from heavy gauge plastic. Interior ridges help to keep your plant from sitting in a pool of water. Keeps your plant roots healthy.



Item #	Desc	UPC	Vendor	CS/UOS	Location
81080040	4"	759188804008	WT-804	25/25	National
81080042	6"	759188806002	WT-806	25/25	National
81080044	8"	759188808006	WT-808	25/25	National

Plastic and Wire Coco Hanging Basket Drip Pans

Designed to clip underneath either an 8", 10" or 12" dia. plastic hanging basket also available in a 12"/14" size that fits under a wire coco basket to catch water overflow protecting floors & decks. It will also work as a watering device by filling it full of water and letting it self water the hanging basket thru absorption. This is very effective in hot dry weather. Indoor and outdoor use.



Item #	Desc	UPC	Vendor	CS/UOS	Location
81080002	8"	759188000882	HB-8050	50/50	National
81080001	10"	759188510008	HB-1150-50	50/50	National
81080268	12"	759188520007	HB-1200S-50	50/50	National
81080271	12"/14"	759188121440	HB-1214S-50	50/50	National



Clear Designer Heavy Plant Saucer

Extra strong heavy gauge clear plastic footed saucers. Protects carpets and floors. These thick plastic trays for indoors and outdoors are engineered with design features that are unique and durable to stand up to frequent and regular use. These will surely protect your terracota plant pots, clay, glassware and plastic plant pots for a long time.

Item #	Desc	UPC	Vendor	CS/UOS	Location
81080056	6"	759188000066	DS-600	25/25	National
81080057	8"	759188000080	DS-800	25/25	National
81080058	10"	759188000103	DS-1000	25/25	National
81080075	10" sq.	759188111014	SQDS-1000	25/25	National
81080059	12"	759188000127	DS-1200	25/25	National
81080076	12" sq.	759188125011	SQDS-1200	25/25	National
81080060	14"	759188000141	DS-1400	25/25	National
81080077	14" sq.	759188145309	SQDS-1400	25/25	National

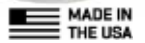

Clear Deep Vinyl Basket Liners

Designed to fit nearly any standard basket. Heavy gauge vinyl liners offer added flexibility and transparency to provide real support for candy and fruit baskets; our heavy-gauge plastic basket liners are best suited for floral arrangements and potted plants. By keeping potting soil and water safely inside the basket, our lineup of plant liners ensure optimal protection for table surfaces and flooring.

Item #	Desc	UPC	Vendor	CS/UOS	Location
81080098	4"	759188000417	L-0041	400/25	National
81080100	5"	759188000516	L-0051	400/25	National
81080102	6"	759188000615	L-0061	300/25	National
81080108	8"	759188000813	L-0081	200/25	National
81080113	10"	759188010003	DL-10001	300/25	National
81080114	11"	759188011000	DL-11001	100/25	National
81080115	12"	759188012007	DL-12001	100/25	National
81080117	14"	759188001407	DL-14001	100/25	National
81080119	16"	759188016005	DL-16001	100/10	National
81080120	17"	759188017002	DL-17001	100/10	National

Clear Vinyl Plant Saucers

The Clear Vinyl Plant Saucers are perfect for indoor and outdoor use to protect all types of floors and decks from water damage by the specially designed airflow bottom which allows air to flow beneath the saucer to prevent moisture build up. The plant saucer catches water overflow allowing the water to be absorbed back into the plant.



Item #	Desc	UPC	Vendor	CS/UOS	Location
81080025	4"	759188040000	CW-400N	1000/50	National
81080026	5"	759188050009	CW-500N	1000/50	National
81080027	6"	759188060008	CW-600N	1000/50	National
81080028	7"	759188070007	CW-700N	1000/50	National
81080029	8"	759188080006	CW-800N	600/50	National
81080030	9"	759188090005	CW-900N	400/50	National
81080031	10"	759188100001	CW-1000N	300/50	National
81080032	11"	759188110000	CW-1100N	200/50	National
81080033	12"	759188120009	CW-1200N	200/25	National
81080034	13"	759188130008	CW-1300N	100/25	National
81080035	14"	759188140007	CW-1400N	100/25	National
81080036	16"	759188160005	CW-1600N	100/10	National
81080037	17"	759188170004	CW-1700N	100/10	National
81080038	21"	759188210007	CW-2100N	25/5	National
81080039	25"	759188250003	CW-2500N	25/5	National

CURTIS WAGNER

PLASTICS

Designer Centerpiece Heavy Plant Tray

Show off your plants without scratches or water damage to your tables. Great for window sill plants as well!



Item #	Desc	UPC	Vendor	CS/UOS	Location
81080089	12" Clear	759188128029	DWT-1200RRP30	30/30	National
81080090	14" Clear	759188014001	DWT-1400RRP30	30/30	National



Cork & Fabric Surface Protector Mat

Decorative mat protects furniture and floors, eliminates scratches, and prevents moisture build up by allowing air flow under the molded plastic base plant mat.

Item #	Desc	UPC	Vendor	CS/UOS	Location
81080012	6" Cork Mat	759188681180	MC-600	25/25	National
81080013	8" Cork Mat	759188888183	MC-800	25/25	National
81080014	10" Cork Mat	759188011185	MC-1000	15/15	National
81080015	12" Cork Mat	759188121181	MC-1200	15/15	National
81080016	14" Cork Mat	759188141189	MC-1400	15/15	National
81080017	16" Cork Mat	759188166182	MC-1600	15/15	National
81080289	4" Dark Cork Mat	759188043278	MCDK-400	25/25	National
81080290	6" Dark Cork Mat	759188683276	MCDK-600	25/25	National
81080291	8" Dark Cork Mat	759188883270	MCDK-800	25/25	National
81080005	6" Asst	759188680008	MC-600A	25/25	National
81080006	8" Asst	759188888008	MC-800A	25/25	National
81080007	10" Asst	759188010102	MC-1000A	15/15	National
81080008	12" Asst	759188120207	MC-1200A	15/15	National



Bear Planter

Heavy cement planter with removable drainage plug. TOD 7.08" | Height 5.82"

Item #	Desc	Vendor	CS/UOS	Location
81792431	Bear Planter	260082P-028	8/8	National

Cow Planter

Heavy cement planter with removable drainage plug, perfect for succulents or houseplants.



Item #	Desc	Vendor	CS/UOS	Location
81792433	Small - Natural Brown	260074P-700	12/12	National
81792434	Small - Light Earth	260074P-147	12/12	National
81792435	Large - Natural Brown	260073P-700	6/6	National
81792436	Large - Light Earth	260073P-147	6/6	National

Yellow Duck Planter w/ Drainage Plug

TOD 6.49" | Height 5.91"



Item #	Desc	Vendor	CS/UOS	Location
81792432	Yellow Duck	260083P-005	8/8	National

Moose Planter w/ Drainage Plug

TOD 6.89" | Height 5.51"



Item #	Desc	Vendor	CS/UOS	Location
81792430	Moose - Light Brown	260081P-455	8/8	National

Cam the Sloth Planter

No drainage, great for drop ins!



Item #	Desc	Vendor	CS/UOS	Location
81792364	Sloth Planter	260031	6/6	National

CEMENT BUDDIES

Forest animal planters | Adorable addition to any home or garden.



2024

Item #	Desc	Vendor	UOS/CS	Location	Item #	Desc	Vendor	UOS/CS	Location	Item #	Desc	Vendor	UOS/CS	Location				
Bird - S: 6.25" x 4" x 4.75" / L: 8.75" x 5.25" x 5.5"					Owl: 4.5" x 4.25" x 4.75" / L: 5.5" x 5" x 6"					Sleeping Cat - S: 7" x 4.75" x 4" / L: 8" x 5.75" x 4.5"								
81791016	Rust - S	9/3411R/1	12/12	National	81791573	Rust - S	260006P-433	12/12	National	81791575	Rust - S	260010P-433	12/12	National				
81791017	Nat - S	9/3411/1	12/12	National	81791565	Nat - S	260006P-396	12/12	National	81791567	Nat - S	260010P-396	12/12	National				
81791018	Rust - L	9/3412R/1	6/6	National	81791572	Rust - L	260005P-433	8/8	National	81791574	Rust - L	260009P-433	6/6	National				
81790079	Nat - L	9/3412/1	6/6	National	81791564	Nat - L	260005P-396	8/8	National	81791566	Nat - L	260009P-396	6/6	National				
Elephant - 7" x 5" x 6"					Piglet - S: 6" x 3.75" x 3.5" / L: 7.5" x 4.75" x 4"					Sleeping Dog: 7" x 6.25" x 3.25"								
81791571	Rust	260004P-433	8/8	National	81791578	Rust - S	260014P-433	12/12	National	81791576	Rust - S	260011P-433	6/6	National				
81791563	Natural	260004P-396	8/8	National	81791570	Nat - S	260014P-396	12/12	National	81791568	Nat - S	260011P-396	6/6	National				
Frog - S: 5.75" x 4.75" x 4" / L: 7.5" x 6" x 5.5"					Rabbit - S: 6" x 4.75" x 3.75" / L: 8" x 6" x 4.5"					Snail - S: 5.75" x 4.5" x 4.25" / L: 8" x 6" x 5.5"								
81791027	Rust - S	9/3431R/1	18/18	National	81791019	Rust - S	9/3441R/1	12/12	National	81791031	Rust - S	9/3471R/1	12/12	National				
81791028	Nat - S	9/3431/1	18/18	National	81790089	Nat - S	9/3441/1	12/12	National	81791032	Nat - S	9/3471/1	12/12	National				
81791029	Rust - L	9/3432R/1	8/8	National	81791020	Rust - L	9/3442R/1	6/6	National	81791033	Rust - L	9/3472R/1	4/4	National				
81791030	Nat - L	9/3432/1	8/8	National	81790088	Nat - L	9/3442/1	6/6	National	81790076	Nat - L	9/3472/1	4/4	National				
Hedgehog - S: 5" x 4.25" x 3" / L: 7.75" x 6" x 4.25"					Turtle - S: 6" x 4.75" x 3.5" / L: 7.75" x 6" x 4.5"													
81791021	Rust - S	9/3431R/1	18/18	National						81791024					Rust - S	9/3451R/1	12/12	National
81791022	Nat - S	9/3431/1	18/18	National						81791025					Nat - S	9/3451/1	12/12	National
81791023	Rust - L	9/3432R/1	8/8	National						81791026					Rust - L	9/3452R/1	6/6	National
81790078	Nat - L	9/3432/1	8/8	National						81790077					Nat - L	9/3452/1	6/6	National

All animals have removable drainage plugs!



Cement Square Planter



Item #	Desc	Vendor	CS/UOS	Location
81792124	Small Natural	3/0935/1	4/4	East

Rooster Planter

Cement rooster planter with removable drainage plug. Open diameter 5" Overall height 7" Volume 0.3 gal



Item #	Desc	Vendor	CS/UOS	Location
81792123	Rooster planter	260027-C148	8/8	National

Cement Shell Planter

Sea Shell planters made of cement feature a removable drainage plug. Opening diameter 5" - Overall height 2.5" Volume 0.15 gal



Item #	Desc	Vendor	CS/UOS	Location
81792121	Light Earth	260025-C147	24/24	East
81792122	Shell Grey	260025-C151	24/24	East
81792222	Harbor Blue	260025-580	24/24	East

Classic Coral Fish

Overall 6.5" long with removable drainage plug.



Item #	Desc	Vendor	CS/UOS	Location
81792196	3.5"	260032-579	16/16	National

Jagger Shell Planter

Cement planter with removable drainage plug. Opening diameter 4 1/2" Overall height 3 1/2" -Volume 0.12 gal



Item #	Desc	Vendor	CS/UOS	Location
81792120	Shell Planter	260024-C149	18/18	National

Large Mouth Fish Planter

Cement planters opening diameter 3 1/2" - overall height 4 1/4" - Volume 0.34 gal Removable drainage plug



Item #	Desc	Vendor	CS/UOS	Location
81792119	Weathered Bronze	260023-C154	16/16	National

Maxwell Planters

Maxwell cement planters with removable drainage plug. Perfect for succulents, foliage or flowers!
Round: 4" x 4"
Urn: 6.5" x 5.75"



Item #	Desc	Vendor	CS/UOS	Location
81792190	Round Straw Weave	210055-587	12/12	East
81792191	Round Country Blue Weave	210055-580	12/12	East
81792192	Urn Straw Weave	270003-587	8/8	East
81792193	Urn Country Blue Weave	270003-580	8/8	East

Cement Car Pots

Cement trucks with removable drainage plug. 5.7" x 3.15" x 2.4"



Item #	Desc	Vendor	CS/UOS	Location
81792173	Truck Antique Red	260000P-006	48/48	East

Artichoke Cement Planter

Gorgeous, heavy cement planters with removable drainage plugs



Item #	Desc	Vendor	CS/UOS	Location
81792353	Small 5.75" x 5.75" x 5"	50011	6/6	East
81792354	Large 8.25" x 8.25" x 6.75"	50012	6/6	East



Zinc and Black Cement Pot Assortments

Small:5.3x5.3x4.7
Large:7.5x7.5x6.1

*Comes with a removable drainage plug



Item #	Desc	Vendor	CS/UOS	Location
81791818	Large Zinc & Black Assorted	31005	8/8	East
81791819	Small MOD Zinc & Black Assorted	31006	12/12	East
81791820	Large MOD Zinc & Black Assorted	31007	8/8	East



Dotted Ceramix Planters

Colorful ceramic containers are perfect additions to your planter selection. Drop in succulents or houseplants. Features removable drainage holes.

Item #	Desc	Vendor	CS/UOS	Location
81792400	2.5" Mix Blue, Green, White & Pink 96 per case	K90072-000	1/1	National
81792405	4" - Black 24 per case	K90108-001	1/1	National
81792404	4" - White 24 per case	K90108-089	1/1	National
81792403	4" Mix Pink, Green, Blue & Purple 24 per case	K90075-000	1/1	National
81792349	5.7" x 4.2" White	50002-WH	16/16	East
81792350	5.7" x 4.2" Black	50002-EB	16/16	East
81792414	6.5" - White 6 per case	K90106-089	1/1	National
81792415	6.5" - Dark Blue 6 per case	K90106-448	1/1	National
81792351	8.27" x 5.35" White	50003-WH	6/6	East
81792352	8.27" x 5.35" Black	50003-EB	6/6	East

Kiawah Ceramic Planters

2024

Ceramic containers are perfect additions to your planter selection. Drop in succulents or houseplants. Features removable drainage holes 4" (Case pack of 24) 6" (Case pack of 12)



Item #	Desc	Vendor	CS/UOS	Location
81792406	4" Sage & Denim	K90080-000	24/1	National
81792410	6" Sage & Denim	K90078-000	12/1	National

Colchester Ceramic Planter

Ceramic containers are perfect additions to your planter selection. Drop in succulents or houseplants. Features removable drainage holes 4" - Case pack 8" -Case pack 6



Item #	Desc	Vendor	CS/UOS	Location
81792407	4" - Grey 24 per case	K90103-781	1/1	National
81792418	8" - Grey 6 per case	K90104-781	1/1	National



Geometric Ceramix Planters

Colorful ceramic containers are perfect additions to your planter selection. Drop in succulents or houseplants. Features removable drainage holes

Item #	Desc	Vendor	CS/UOS	Location
81792401	4" Asst Pink Green Blue Purple 24 per case	K90073-000	1/1	National
81792402	4" Mix White & Black 24 per case	K90074-000	1/1	National
81792345	5.7" x 4.2" White	50000-WH	16/16	East
81792346	5.7" x 4.2" Black	50000-EB	16/16	East
81792412	6.5" White 6 per case	K90105-089	1/1	National
81792413	6.5" Dark Blue 6 per case	K90105-448	1/1	National
81792416	8" White 4 per case	K90107-089	1/1	National
81792417	8" Dark Blue 4 per case	K90107-448	1/1	National
81792347	8.27" x 5.35" White	50001-WH	6/6	East
81792348	8.27" x 5.35" Black	50001-EB	6/6	East

Artie Ceramic Planter

These detailed ceramic containers are perfect for houseplants. Features removable drainage plug. Case pack of 8. (4 each Quarry / Grey)



Item #	Desc	Vendor	CS/UOS	Location
81792411	6" Quarry & Gray 8 per case	K90079-000	1/1	National



Self-Watering Raised Garden Bed

Item #	Desc	Vendor	CS/UOS	Location
81792439	30"	740000P-101	4/4	National

Square Planter



Deck Rail Window Box



Window Box

Falmouth Planter

Item #	Desc	Vendor	CS/UOS	Location
81792427	11" square white	1071CP18B-340V	18/18	East
81792428	24" Deck Rail Window Box	1074CP10B-340V	10/10	East
81792429	24" Window Box	1075CP16B-340V	16/16	East

Bella Planter

At a height of 9.5" and a top outside diameter of 9.9", the Bella planters are fantastic for all your plantings requiring a deeper rooting solution. Made of plastic resin.



Magenta Metallic Pearl

Metallic Frosted Pearl

Item #	Desc	Vendor	CS/UOS	Location
81791041	7" Metallic Frosted Pearl	1258-027M	25/25	East
81791900	7" Metallic Pearl	1258-147M	25/25	National
81792109	7" Magenta	1258D-411V	25/25	National
81791043	10" Metallic Pearl	1255-147M	20/20	National
81791897	10" Metallic Frosted Pearl	1255-027M	1/20	East

Cement Coffee Cup

Comes with a removable drainage plug. 7" x 5.5" x 5" - fits 4.5" pot.



Item #	Desc	Vendor	CS/UOS	Location
81791533	Rust	3/12819R/1	12/12	East



Cement Heart Pots

Made of cement and featuring a removable drainage plug these containers are perfect for succulents or foliage plants.

Item #	Desc	Vendor	CS/UOS	Location
81791694	Red Heart 4.7X4.7x6.5	210027P-396	12/12	East
81791695	Red Heart 5.5X5.5x5.1	210028P-396	12/12	East
81791696	Red Heart 4.3X4.3x4	210029P-396	18/18	East
81791697	Red Heart Low Bowl 6.5X6.5x3.1	280000P-396	12/12	East
81791709	Red Wash White Heart 5.2X5.2x4.9	210019-131	12/12	East
81791710	Red Wash White Heart	210019P-328	12/12	East

Yellow Sun Cement Pot

Cement planter with removable drainage plug. Open diameter 4 1/3" Overall height 4" Volume 0.55 gal



Item #	Desc	Vendor	CS/UOS	Location
81792198	4.3" x 4"	210054P-396	16/16	East

Wood Grain Ceramic Planter

White ceramic band complements wood grain, has removable drainage plug.



Item #	Desc	Vendor	CS/UOS	Location
81792355	White with Wood Grain 5.25"x5"	50022	12/12	East

Flora Trio

Cement planters with assorted white and green interiors. Perfect for any houseplant. Comes with a removable drainage plug.



Item #	Desc	Vendor	CS/UOS	Location
81791813	5.3x5.3x4.7	31000	12/12	East
81791814	7.5x7.5x6.1	31001	6/6	East



Lavastone Luzon Urn

14.25" W x 13.25" H
has drainage plug.



Item #	Desc	Vendor	CS/UOS	Location
81792184	14.25 X 13.25	LS7415	1/1	East

Tin Planters

7.1" x 7.1" x 5.9" & 5.1" x 5.1" x 4.92"



Item #	Desc	Vendor	CS/UOS	Location
81791404	Set of 2	13055	2/2	East

2024

Tin Planter w/ Faux Hose



Item #	Desc	Vendor	CS/UOS	Location
81791418	12"x7"x11"	13069	4/4	East

License Plate Metal Planters

Rectangle Sizes: L: 11.6"x6.3"x5.9"
S: 8.7"x4.7"x5.5"
Round Sizes: L: 8.9"x8.9"x6.9"
S: 8.1"x8.1"x6.7"
Square Sizes: L: 6"x6"x6"
S: 5"x5"x5.5"



Item #	Desc	Vendor	CS/UOS	Location
81791372	Rectangle	13013	2/2	East
81791373	Round	13014	2/2	East
81791398	Square	13048	2/2	East

Ancient Cement Planters

Aged cement planter with removable drainage plug



Item #	Desc	Vendor	CS/UOS	Location
81792150	8"X8"X7"	45000	6/6	East

Ancient Cement Handled Planter

Comes with removable drainage plug



Item #	Desc	Vendor	CS/UOS	Location
81792152	6.5X5X4.3	45002	12/12	East

Dakota Trough

Cement planter with removable drainage plug.
8" x 3" x 3"



Item #	Desc	Vendor	CS/UOS	Location
81791532	Earth Moss	240001P-432	16/16	National
81791531	Rust	240001P-433	16/16	National

Weathered Copper Tommy Pot

Copper finish resin planter w/ drainage
8" x 6" Volume .71 gal



Item #	Desc	Vendor	CS/UOS	Location
81792097	8" Tommy Pot	108D-377R	12/12	National

Jake Planter

14" Resin planter straw finish with drainage. Feels and looks real! Overall height 10" - Holds 4 gallon volume



Item #	Desc	Vendor	CS/UOS	Location
81792085	14" Jake planter	2014D-587R	12/12	National



Galvanized Insert

Rustic wooden planter box features a galvanized metal facing for contrast. 16" L X 6" W X 5" H

Item #	Desc	Vendor	CS/UOS	Location
81791010	Galvanized	2/934/1	12/12	National

Holiday Star Window Box

Golden galvanized planter with holiday stars fits two 6" pots. No drainage



Item #	Desc	Vendor	CS/UOS	Location
81791001	Gold	155244-G	24/24	East

Galvanized Brushed Wood Grain Tin White



Item #	Desc	Vendor	CS/UOS	Location
81791035	6"	510001-089	40/40	National
81791037	8"	510000-089	36/36	East

Santa With Reindeer

Glazed ceramic santa with reindeer. Great for drop ins! No drainage



Item #	Desc	Vendor	CS/UOS	Location
81792013	5.3"x4.8"x4.8"	260030P-031	24/24	East

Polar Bear With Igloo

Great for drop ins! No drainage



Item #	Desc	Vendor	CS/UOS	Location
81792011	6.6"x4.3"x5"	260028P-089	18/18	East

Handled - Buffalo Brown

Wooden planter box is perfect for plants and displays.



Item #	Desc	Vendor	CS/UOS	Location
81791012	16"x6"x5"	2/60442/1	12/12	National

Birch Oval Planter

Beautiful Birch oval resin planter, with no drainage. Choose from two sizes. 12" L x 6" W x 6.5" H (1.22gal) 16" L x 6.1" W x 6.5" H (1.8gal)



Item #	Desc	Vendor	CS/UOS	Location
81792374	12"	512D-516	24/24	East
81792382	16"	516D-516	20/20	East

Christmas Ornament Planters

Great for drop ins! No drainage



Item #	Desc	Vendor	CS/UOS	Location
81792057	5.75"-Green	159213GR	12/12	East
81792056	5.75"-White	159213S	12/12	East



North Star Pot

Mixed case pack of ceramic white, gold, red, and silver with north star raised prints. Features removable drainage plugs. Case pack of 24 - 6 of each color

Item #	Desc	Vendor	CS/UOS	Location
81792408	Case of 24 White, Gold, Red, Silver	K90076-000	1/1	National

Penguin & Frosty MixPlanter

Heavy cement planters come in a mixed case pack with Penguin and Snowman. Fits a 4" pot and has a removable drainage plug. Case pack of 18 - 9 each Penguin/Snowman



Item #	Desc	Vendor	CS/UOS	Location
81792409	4" Penguin & Frosty Mix	K90077-396	1/1	National



Tilden Self Watering Pots

6" self watering features a total of five pots (2 white 2 gray 1 teal). Pricing per set

Item #	Desc	Vendor	CS/UOS	Location
81792344	6" - 5 colors	10106CP5D-000V	1/1	National
81792342	8",10", & 12" - White	10111D-622V	1/1	National
81792343	8",10", & 12" - Grey	10111D-621V	1/1	National
81792388	6" - Grey set of 5	10106CP5D-621V	1/1	National



Elle Planter w/ Plug

Resin planter with drainage plug, upgrade any houseplant!

Item #	Desc	Vendor	CS/UOS	Location
81792368	4.7" Gray	404CP24D-352	24/24	National
81792370	4.7" Sand	404CP24D-586	24/24	National
81792366	4.7" Cast	404CP24D-060	24/24	National

Capello Planter

6" Capello resin hanging basket with saucer and hanger. Perfect for dropping in succulents or houseplants. Hanging basket opening diameter 6.69" x 4.53" high. Comes with 18" braided hanger and snap on saucer. Holds .48gal soil volume. Choose from Sandstone, Star White, Black or Antique Copper



Item #	Desc	Vendor	CS/UOS	Location
81792239	6" Sandstone	2001MS6D-045PHNG	50/50	National
81792240	6" Star White	2001MS6D-340PHNG	50/50	National
81792262	6"-Antique Copper w/ black hanger	2001MS6D-174PHNG	50/50	National



Corinthian Collection

Trough: 10"X3.5"x3.25"
Round: 10"X3.5"x3.25"

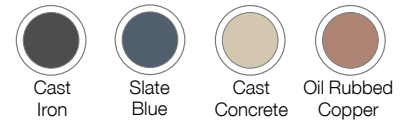

Item #	Desc	Vendor	CS/UOS	Location
81792017	8" Round Cast Concrete	9408CP28D-060	28/28	National
81792018	8" Round Desert	9408CP28D-514	28/28	National
81792199	8" Round Slate Blue	9408CP28D-597	28/28	National
81792019	8" Round Storm	9408CP28D-515	28/28	National
81792071	8" Round Oil Rubbed Copper	9408CP28D-238	28/28	National
81791735	10" Trough Storm	9410-515 CP	36/36	National
81791732	10" Trough Cast Concrete	9410-060 CP	36/36	National
81791733	10" Trough Desert	9410CP36D-514	36/36	National
81791725	10" Round Desert	9411CP28D-514	28/28	National
81791727	10" Round Storm	9411D-515	28/28	National
81791724	10" Round Cast Concrete	9411CP28D-060	28/28	National
81792210	10" Round Slate Blue	9411CP28D-597	28/28	National
81792072	10" Round Oil Rubbed Copper	9411CP28D-238	28/28	National
81791047	12" Bowl Cast Iron	9478D-059	12/12	National
81791046	12" Bowl Cast Concrete	9478D-060	12/12	National
81791165	12" Bowl Oil Rubbed Copper	2/9478/1-097	12/12	National
81791731	13" Round Storm	9413-515 CP	20/20	National
81791728	13" Round Cast Concrete	9413CP20D-060	20/20	National
81791729	13" Round Desert	9413CP20D-514	20/20	National
81792073	13" Round Oil Rubbed Copper	9413CP20D-238	20/20	National
81792212	10" Trough Slate Blue	9410CP36D-597	36/36	National
81792074	18" Trough Cast Concrete	9418CP36D-060	36/36	National
81792075	18" Trough Desert	9418CP36D-514	36/36	National
81792076	18" Trough Storm	9418CP36D-515	36/36	National
81792077	18" Trough Oil Rubbed Copper	9418CP36D-238	36/36	National
81792223	18" Trough Slate Blue	9418CP36D-597	36/36	National



Allaire Tall Planter

Resin planter with drainage hole 12"
Open diameter x 13.5" Height Holds
3.77gal soil volume

Item #	Desc	Vendor	CS/UOS	Location
81791523	12" Round	3/804CG/1	12/12	East



Greenwich Urn

Resin Urns - bottoms screw on and off for easy storage 16"x16"x18"

Item #	Desc	Vendor	CS/UOS	Location
81791759	Striated Granite	39451D-518R CP	6/6	East
81791758	Striated Fossil	394851D-039R CP	6/6	East



Bellina Planter

Fossil

Item #	Desc	Vendor	CS/UOS	Location
81791075	8" Fossil	50D-039T	50/50	East
81791078	10" Fossil	51D-039T	25/25	East



Larissa Urn

Resin urn 16" opening diameter, 19" height
Volume 9.4 gal

Item #	Desc	Vendor	CS/UOS	Location
81792136	16"-Sand	416P-190	4/4	East



Honeysuckle Planters

Resin planters with drainage.
13" Opening diameter - 10 1/2" height Volume 3.6 gal
15" Opening diameter - 12 1/4" height 5.6 gal

Item #	Desc	Vendor	CS/UOS	Location
81791099	13" Fossil	554D-039T	48/48	National
81791101	13" Stone	554D-120T	48/48	National
81791104	13" Blue Jean	554D-252R	48/48	National
81792114	13" Tequila Sunrise	554D-245R	48/48	National
81792116	13" Distressed Copper	554D-183R	48/48	National
81791093	15" Stone	553D-120T	24/24	National
81791096	15" Blue Jean	553D-252R	24/24	National
81792115	15" Tequila Sunrise	553D-245R	24/24	National
81792117	15" Distressed Copper	553D-245R	24/24	National
81791630	15" Vanilla	553D-290S	24/24	National
81791605	15" Fossil	553D-039T	20/20	East

16" Legacy Urn

Durable resin urns, hold 4.1gal. Opening diameter 15.9", overall height 20.1"
Choose from cast concrete or oil rubbed bronze finish to elevate plantings



Item #	Desc	Vendor	CS/UOS	Location
81792134	Cast Concrete	569D-060	4/4	National
81792135	Oil Rubbed Bronze	569D-238	4/4	National



Distressed Barrel Planters

Item #	Desc	Vendor	CS/UOS	Location
81791351	6" - Chestnut	34906D-407R	120/120	National
81791888	8" - Chestnut	34908D-407R	80/80	National
81790010	9" - Oak	S74D-265R	30/30	National
81790011	15" - Oak	S72D-265R	18/18	National
81791892	15" - Kentucky Walnut	S72D-037R	18/18	National
81790012	20.5" - Oak	S1027D-265R	10/10	National



Jameson Deck Rail Planters

Item #	Desc	Vendor	CS/UOS	Location
81791361	15" - Round	1072D-265R	18/18	National
81791362	24"-Window Box	1073D-265R	12/12	National

2024



Moroccan Bowl

Resin planter with drainage plug.
7" x 2 3/4"
10" x 4"

Item #	Desc	Vendor	CS/UOS	Location
81792078	7" Cast Concrete	577D-060	50/50	National
81792079	7" Oil Rubbed Bronze	577D-097	50/50	National
81792080	7" Desert	577D-514	50/50	National
81792081	7" Storm	577D-515	50/50	National
81792082	7" Slate Blue	577D-597	50/50	East
81791740	10" Cast Concrete	572D-060 CP	20/20	National
81791741	10" Oil Bronze	572D-097 CP	20/20	National
81791742	10" Desert	572D-514 CP	20/20	National
81791743	10" Storm	572D-515 CP	20/20	National

Doherty 12" Pots

12" resin planters with drainage.
Opening diameter 11.62" Overall height 9.12" Volume 2.75gal - Great for drop ins or to grow in!



Item #	Desc	Vendor	CS/UOS	Location
81792106	Grained Sky Blue	112D-555R	16/16	National
81792108	Grained White	112D-561R	16/16	National
81792107	Grained Aurora Red	112D-556R	16/16	National

14" Super Bowl Planters

14" resin planters with drainage.
8" height, holds 2.75gal soil volume.



Item #	Desc	Vendor	CS/UOS	Location
81792185	Distressed Galvanized	9415D-531R	10/10	East
81792186	Vintage Ivory Enamel	9415D-532R	10/10	East

Umbria Eco Cast Planter

Heavy plastic resin planter. Great for retailing or planting up.



Item #	Desc	Vendor	CS/UOS	Location
81791130	12"	3/9475/1-060	12/12	National



Alena Collection Weathered design

9": 8.9"x8.9"x6.25"
12": 12"x12"x8.5"

Item #	Desc	Vendor	CS/UOS	Location
81791761	9" Enamel	10509D-532 CP	26/26	East
81791760	9" Galvanized	10509D-531 CP	26/26	East
81791861	9" Copper	10509D-377R CP	26/26	East
81791763	12" Enamel	10512D-532 CP	20/20	East
81791762	12" Galvanized	10512D-531 CP	20/20	East
81791862	12" Copper	10512D-377R CP	20/20	East
81792187	12" Teal Gloss	10512CP20D-558R	20/20	East
81792188	12" Ruby Red Gloss	10512CP20D-560R	20/20	East

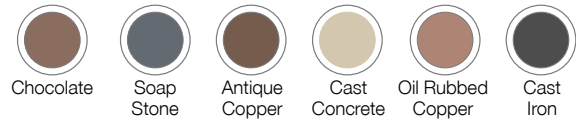

Haverhill (A)

Item #	Desc	Vendor	CS/UOS	Location
PLANTER				
81791143	12" Soap Stone	FM1403D-017PB	30/30	National
81791145	12" Antique Copper	FM1403D-174PB	30/30	National
81792293	12" Hanging Basket w/18" Hanger- Antique Copper	FM1412CP42D-174PB	42/42	National
BOWL				
81791141	12" Antique Copper	FM1402D-174PB	30/30	National
81791139	12" Soap Stone	FM1402CP30D	30/30	National

Spartan Eco Cast Urn (B)

Item #	Desc	Vendor	CS/UOS	Location
81791049	12" Chocolate	568D-059	10/10	East
81791048	12" Cast Concrete	568D-060	10/10	East
81791050	12"-Oil Rubbed Copper	568D-238	10/10	East

Greco (C)

Item #	Desc	Vendor	CS/UOS	Location
81791108	15" Cast Concrete	563D-060	12/12	National

Nantucket Planter (D)

Item #	Desc	Vendor	CS/UOS	Location
81791352	8" Russet	34208D-408R	20/20	National
81791353	8" Harbor Gray	34208D-409R	20/20	National
81791354	10" Russet	34210D-408R	20/20	National
81791355	10" Harbor Gray	34210D-409R	20/20	National
81791356	12" Russet	34212D-408R	12/12	National
81791357	12" Harbor Gray	34212D-409R	12/12	National



Shaina Planter 15"

Great for drop ins! No drainage

Item #	Desc	Vendor	CS/UOS	Location
81791447	Earth	8005D-188T	12/12	East
81791445	Patina Copper	8005D-378R	12/12	East
81791446	Northern Lights	8005D-379R	12/12	East
81791443	Weathered Copper	8005D-377R	12/12	East
81791444	Indigo	8005D-375R	12/12	East



Rosie Bowl with Saucer 10"

10" L x 10" W x 5" H

Item #	Desc	Vendor	CS/UOS	Location
81791437	Northern Lights	9010D-379R	12/12	National
81791439	Weathered Copper	9010D-377R	12/12	National
81791438	Indigo	9010D-375R	12/12	National
81791435	White	9010D-4055	12/12	National
81791436	Earth	9010D-188T	12/12	East

SUTTON PARK COLLECTION

Elegant design | Pre-drilled holes allow for drainage.



ROUND All 12" round planters come with cage

2024

Item #	Desc	Vendor	CS/UOS	Location
WINDOW BOX				
81791316	15" Oil Rubbed Copper	6004D-164PB	44/44	National
81791315	15" Slate	6004D-287PB	44/44	National
SQUARE				
81791296	7" Oil Rubbed Copper	7010D-164PB	34/34	National
81791295	7" Slate	7010D-287PB	34/34	National
81791300	10" Oil Rubbed Copper	3006D-164PB	28/28	National
81791299	10" Slate	3006D-287PB	28/28	National
BOWL				
81791312	11" Oil Rubbed Copper	6002D-164PB	64/64	National
81791311	11" Slate	6002D-287PB	64/64	National
HANGING BASKET -come with a water saving disc and hanger				
81791288	11" Oil Rubbed Copper	6003D-164PB	38/38	National
81791287	11" Slate	6003D-287PB	38/38	National
81792361	13" Oil Rubbed Copper	6005CP54D-164PB	54/54	National
81792363	13" Slate	6005CP54D-287PB	54/54	National

Item #	Desc	Vendor	CS/UOS	Location
81791292	7" Oil Rubbed Copper	90008D-164PB	34/34	National
81791291	7" Slate	90008D-287PB	34/34	National
81791324	8.5" Oil Rubbed Copper	90004D-164PB	40/40	National
81791323	8.5" Slate	90004D-287PB	40/40	National
81791303	11" Slate	3004D-287PB	38/38	National
81791304	11" Oil Rubbed Copper	3004CP38D-164PB	38/38	National
81791537	12" Verde Stone w/cage	90005D-036PB	270/270	National
81791330	12" Chocolate w/cage	90005D-002P	38/38	National
81791332	12" Oil Rubbed Copper w/cage	90005D-164PB	38/38	National
81791538	12" Verde Stone w/cage	90005D-036PB	1080/1080	National
81791536	12" Verde Stone w/cage	90005CP38D-036PB	38/38	National
81791307	13" Slate	1403D-287PB	30/30	National
81791308	13" Oil Rubbed Copper	1403CP30D-164PB	30/30	National



Nassau Round with Cage

Item #	Desc	Vendor	CS/UOS	Location
81791162	12" Antique Copper	3009D-174PB	270/270	National
81791072	12" Antique Copper	3009D-174PB	1080/1080	National



Ashton Manor Collection

12" Hanging Basket: Comes with 18" hanger and disc. 1.8 gal
14" Tall Round: 13.25"x13.25"x14"

Item #	Desc	Vendor	CS/UOS	Location
81791764	Hanging Basket -Oil Rubbed Copper	1502D-164PB CP	48/48	National
81791765	Hanging Basket -Quartz	1502D-053PB CP	48/48	National
81791766	Tall Round-Oil Rubbed Copper	1508D-164PB CP	25/25	National
81791767	Tall Round-Tuscan Stone	1508D-035PB CP	25/25	National

ACACIA WOOD COLLECTION



Item #	Desc	Vendor	CS/UOS	Location
81791711	Trellis Planter 13.8"x13.8"x15.3"x45.7"	160014	1/1	National
81791712	1/2 Barrel Planter 19.7"x13.8"x7.5" 15"x11.8"x6.7"	160015	1/1	National
81791713	Oval Planter 18.1"x10.2"x9.5" 15.4"x8.3"x8.3"	140011	1/1	National
81791009	Barrel Trio Sold As Set Of 3; SM: 11.38"x7"H; MED: 12.88"x8.38"H; L: 15.63"x9.63H	5/800/3	1/1	National
81791714	21" Barrel Planter 20.9"x20.9"x12.6"	110024	4/4	National
81791715	16" Barrel Planter 15.7"x15.7"x9.5"	110025	6/6	National



Stand



Obelisk

4-Arm Black Plant Stand

All in one folds down flat no hardware needed



Item #	Desc	Vendor	CS/UOS	Location
81792138	64.5"	H18003	1/1	East

Wood Plant Stand

Item #	Desc	Vendor	CS/UOS	Location
81790081	27"x18"x45"	9/801/1	1/1	National

Wood Obelisk

Item #	Desc	Vendor	CS/UOS	Location
81790082	15"x15"x61"	9/802/1	1/1	East

Arc Bowl Planter

With Drainage plug
12.5"x8.5"x5.25"



Item #	Desc	Vendor	CS/UOS	Location
81791748	Stone	573D-120 CP	20/20	National
81791749	Desert	573D-514 CP	20/20	National
81792084	Concrete	573D-102	20/20	National
81792083	Georgia Clay	573D-093	20/20	National



Terranova Cylinder



Item #	Desc	Vendor	CS/UOS	Location
81791918	8" Black	TN8D-001P CP	250/250	National
81791920	8" Terra Cotta	TN8D-020P CP	250/250	National
81791922	8" Charcoal	TN8D-101P CP	250/250	National
81791923	8" Antique Copper	TN8D-174PB CP	250/250	National
81791919	8" Chocolate	TN8D-002P CP	250/250	National
81791933	10" Sand Stone	TN10D-045P CP	250/250	National
81791947	12" Antique Copper	TN12D-174PB CP	250/250	National
81791946	12" Charcoal	TN12D-101P	250/250	National
81791942	12" Black	TN12D-001P CP	250/250	National
81791943	12" Chocolate	TN12D-002P CP	250/250	National
81791945	12" Sand Stone	TN12D-045P CP	250/250	National
81791954	14" Black	TN14D-001P CP	250/250	National
81791955	14" Chocolate	TN14D-002P CP	250/250	National
81791959	14" Antique Copper	TN14D-174PB CP	250/250	National
81791957	14" Sand Stone	TN14D-045P CP	250/250	National

Verona Planters

Step up your plantings with these beautiful resin containers. 11" Hanging Basket comes with hanger and water disk, holds 1.8gal 11" Round with drainage holds 2.2gal 10" Square with drainage holds 2.4gal



Item #	Desc	Vendor	CS/UOS	Location
81792125	11" Hanging Basket Soapstone	1420D-017PB	30/30	East
81792126	11" Round Soapstone	1424D-017PB	20/20	East
81792127	10" Square Soapstone	1422D-017PB	20/20	East

2024

Chandler Round Pot

14" resin planter with drainage 14" opening diameter 12" height - Holds 4.97gal volume



Item #	Desc	Vendor	CS/UOS	Location
81792202	14"-Black	4015CP-12D-001P	12/12	East



Devoncourt Planters

Resin planters with drainage 11" hanging basket comes with hanger and water disc - holds 1.8 gal volume. 11" round holds 2.2 gal, 10" square holds 2.4 gal

Item #	Desc	Vendor	CS/UOS	Location
81792128	11" HB Antique Copper	1400D-173PB	30/30	East
81792130	10" Sq Antique Pewter	1402D-173PB	20/20	East
81792242	20" Window Box Antique Copper	1405D-174PB	24/24	East
81791060	11" Round Antique Pewter	1404D-173PB	24/24	East



Self-Watering Planter

Self watering pot. The perfect balance of water, air and soil will insure healthy plants. Soluble fertilizer may be added to the water.



Item #	Desc	UPC	Vendor	CS/UOS	Location
80930563	6" Light Grey w/ Saucer	069244466201	4606-20	6/6	East
80930565	6" Mocha w/ Saucer	069244466546	4606-54	6/6	East
80930568	8" Light Grey w/ Saucer	069244468205	4608-20	6/6	East
80930567	8" Tall Mocha	069244358544	3508-54	6/6	East
80930545	10" Light Grey w/ Saucer	069244460209	4610-20	6/6	East
80930549	12" Light Grey w/ Saucer	069244462203	4612-20	6/6	East
80930548	12" Tall Mocha	069244352542	3512-54	6/6	East



AZURA SERIES

Molded Plastic | *Textured surface offers distinctive natural material look*



Square Patio Planter (A)

Holds approximately 5.20 gallons 15.25" x 15.25" x 12.25".

Item #	Desc	UPC	Vendor	CS/UOS	Location
80930008	15" Cappuccino	069244145144	1415-14	6/6	East
80930009	15" Granite	069244145304	1415-30	6/6	East
80930010	15" Black	069244145366	1415-36	6/6	East

Urn Planter (B)

Embossed pattern, holds 4.53 gallons 15.25"x20.25".

Item #	Desc	UPC	Vendor	CS/UOS	Location
80930012	15" Cappuccino	069244142143	1420-14	6/6	East
80930013	15" Granite	069244142303	1420-30	6/6	East
80930015	15" Black	069244142365	1420-36	6/6	East

Rectangular Patio Planter (C)

Holds 5.76 gallons 27" x 11" x 8¾"

Item #	Desc	UPC	Vendor	CS/UOS	Location
80930019	Cappuccino	069244147148	1427-14	6/6	East
80930020	Granite	069244147308	1427-30	6/6	East
80930021	Black	069244147360	1427-36	6/6	East

Round Patio Planter (D)

This Azura round patio planter holds approximately 4.23 gallons 15.25" x 9.75".

Item #	Desc	UPC	Vendor	CS/UOS	Location
80930004	15" Cappuccino	069244140149	1410-14	6/6	East
80930005	15" Granite	069244140309	1410-30	6/6	East
80930006	15" Black	069244140361	1410-36	6/6	East



Distinction Window Box (E)

Both flexible and durable. Perfect for indoor and outdoor use. All planters from the Distinction line are UV protected. 24" x 7" x 7" 3.28 gal, 30" x 7" x 7" 4.11 gal.

Item #	Desc	UPC	Vendor	CS/UOS	Location
80930173	24" Black	069244224368	4224-36	6/6	East
80930174	24" Dune Sand	069244224580	4224-58	6/6	East
80930176	24" Terra Cotta	069244224719	4224-71	6/6	East
80930184	30" Dune Sand	069244231588	4230-58	6/6	East
80930185	30" Terra Cotta	069244231717	4230-71	6/6	East
80930183	30" Black	069244231366	4230-36	6/6	East
80930182	30" White	069244231090	4230-09	6/6	East

Futura Window Box (F)

Indoor/outdoor use. Product supplied with a plug for indoor use and perforated cap for outdoor use.

Item #	Desc	UPC	Vendor	CS/UOS	Location
80930071	18" Cappuccino	069244282146	2800/0-14	6/6	East
80930073	18" Terra Cotta	069244282719	2800/0-71	6/6	East
80930079	24" Cappuccino	069244291148	2900/0-14	6/6	East
80930085	24" Terra Cotta w/ brackets	069244296716	2900/6-71	6/6	East

Nova Balcony Planter (G)

Terra Cotta window box, includes plastic brackets and drainage plug. Measures. 30" x 8" x 5" and holds 3.30 gal.

Item #	Desc	UPC	Vendor	CS/UOS	Location
80930061	30"	069244260717	2030/6-71	6/6	East



Harmony Tall Planter

Self-watering planter. Unique textured vertical finish. Overflow protection.

Item #	Desc	UPC	Vendor	CS/UOS	Location
80930094	12" Black	069244352368	3512-36	6/6	East
80930099	16" Black	069244356366	3516-36	4/4	East



Futura Patio Planter

Classic design. Thick walled made of food safe materials. Drainage plug included. Recyclable UV treated to resist fading.



Item #	Desc	UPC	Vendor	CS/UOS	Location
80930428	18" Round Black	069244418361	4018-36	6/6	East

Harmony Rail Planter

Self-watering planter with a unique textured vertical finish. Features overflow protection. Ideal for growing vegetables and herbs. Unique notched base fits on either a 2" x 4" or 2" x 6" rail. 27" x 11³/₄" x 9¹/₂" holds 6.2 gal.



Item #	Desc	UPC	Vendor	CS/UOS	Location
80930105	Portabello	069244357387	3527-38	6/6	East
80930306	Slate	069244357042	3527-04	6/6	East



Bamboo Self-Watering Planter

Contemporary Design Planters with a unique textured horizontal finish, water reservoir and overflow protection.

Item #	Desc	UPC	Vendor	CS/UOS	Location
80930481	5" Slate	069244885040	8805-04	6/6	East
80930482	5" Blue	069244885101	8805-10	6/6	East
80930483	5" Red	069244885514	8805-51	6/6	East
80930484	5" Green	069244885804	8805-80	6/6	East
80930498	13" Blue	069244883107	8813-10	6/6	East



Trivet & Caddie Display

DISPLAY RACK ONLY NO CADDIES OR STANDS INCLUDED



Item #	Desc	UPC	Vendor	CS/UOS	Location
81920347	Black	702085411237	RN198B	1/1	East

River North Caddy

Powder coated finish over steel that includes decorative tray and hidden wheels for easy moving of heavy house plants.



Item #	Desc	UPC	Vendor	CS/UOS	Location
81920196	14" Black	635483011122	RN112B	6/6	National
81920197	17" Black	635483011139	RN113B	6/6	National

Black Trivet



Item #	Desc	UPC	Vendor	CS/UOS	Location
81920198	8"	635483011146	RN114B	6/6	East
81920199	10"	635483011153	RN115B	6/6	National
81920200	12"	635483011160	RN116B	6/6	National

Succulent Planter

Large Succulent Planter with weathered galvanized finish. 12" Diameter x 6" Height. Planting area: 12"x12"x3" deep



Item #	Desc	UPC	Vendor	CS/UOS	Location
81920337	Galvanized planter	702085411381	CD145L	4/4	East



Round Corrugated Tub Planters

Set of 3 planters with drainage holes
 Small: 14"W x 11"D
 Medium: 15"W x 12"D
 Large: 17"W x 14"D
 2 sets of 3 per case



Item #	Desc	UPC	Vendor	CS/UOS	Location
81920108	S:14" M:15" L: 17"	702085410216	CD123	2/2	East

Oval Corrugated Tub Planters

Set of 3 planters with drainage holes
 Small: 13"W x 10"D x 10"H
 Medium: 15"W x 12"D x 11"H
 Large: 17"W x 14"D x 12"H
 2 sets of 3 per case



Item #	Desc	UPC	Vendor	CS/UOS	Location
81920101	S:13" M:15" L:17"	702085407841	CD112	2/2	East



Venetian Planters

Item #	Desc	UPC	Vendor	CS/UOS	Location
81920331	A Wall	702085411367	CD129	6/6	National
81920104	B Round-Set of 3	702085408442	CD118	2/2	East
81920103	C S:12" M:17" L:21"	702085408435	CD117	2/2	East
81920105	D 20"x7"x6"	702085408459	CD119	6/6	East
81920113	E Sq:7" Ro:7" Ov:9"	702085410070	CD130	18/18	East

DECORATIVE METAL PLANTERS

Sturdy construction | Great for indoor and outdoor use.

Fancy Bicycle Planter

22" L x 10" W x 19" H - Holds 10" pot (pot not included) Natural Patina



Item #	Desc	UPC	Vendor	CS/UOS	Location
81920090	Bicycle	702085400279	BK101	4/4	East

Pitcher Planters

Corrugated Pitcher Planters with drainage holes. 11" diam. base x 12" H (Holds 10" pot, not included)



Item #	Desc	UPC	Vendor	CS/UOS	Location
81920102	Corrugated	702085408152	CD115	4/4	East
81920334	Silver/white	702085411329	CD142	4/4	East

All I Need Metal Planters

Small: 9" x 7"
 Medium: 10" x 8"
 Large: 12" x 9"
 2 sets of 3 per case with drainage holes



Item #	Desc	UPC	Vendor	CS/UOS	Location
81920111	S: 9" M: 10" L: 12"	702085409593	CD127	2/2	East

Dairy Jug Variety Pack

Rustic galvanized Dairy Jug Planters with drainage hole. Cream/Galvanized 4 sets of 2 per case.
 Small: 9" diam. x 11" H (Holds 8" pot, not included)
 Large: 12" diam. x 14" H (Holds 10" pot, not included)



Item #	Desc	UPC	Vendor	CS/UOS	Location
81920332	Cream & Galv Set of 2	702085410117	CD131	4/4	East



Wall Planter Variety Pack

Contains 2 of each: Butterfly (WB146), Dragonfly (WB142), Floral (WB148).



Item #	Desc	UPC	Vendor	CS/UOS	Location
81920307	14" Natural Patina	702085408589	WBVP101	6/6	East
81920308	14" Black	702085408596	WBVP101-BLK	6/6	East

Mini Round Basket With Coco Liner



Item #	Desc	UPC	Vendor	CS/UOS	Location
81920021	Black	702085406066	BA120-BLK	8/8	National
81920020	Natural Patina	702085400132	BA120	8/8	National

Peacock Wall Basket With Coco Liner

Planting area 15" x 8" x 8"
Basket size 18" x 8" x 19"



Item #	Desc	UPC	Vendor	CS/UOS	Location
81920257	Black	702085405991	WB107-BLK	6/6	East
81920256	Natural Patina	702085400187	WB107	6/6	East

Rectangular Twist Basket With Coco Liner

Planting area is 13" x 9" x 7" deep
13" height with handle



Item #	Desc	UPC	Vendor	CS/UOS	Location
81920026	Black	702085405892	BA127-BLK	6/6	East
81920025	Natural Patina	702085400149	BA127	6/6	East

Daisy Wall Basket with Coco Liner

Planting area: 13" x 8" x 7"
Basket size: 15" x 9" x 25"



Item #	Desc	UPC	Vendor	CS/UOS	Location
81920279	Black	702085406004	WB135-BLK	6/6	East
81920278	Natural Patina	702085400194	WB135	6/6	East



Hanging basket variety pack

Hanging basket variety pack in black finish features 2 each floral, daisy, arch style. Basket size 16" diameter x 9" deep

Item #	Desc	UPC	Vendor	CS/UOS	Location
81920070	2 each hanging	702085408558	BAVP101-BLK	6/6	East

Finial X Wall Basket with Coco Liner

Planting area: 15" x 8" x 11"
Basket size: 22" x 11" x 37"



Item #	Desc	UPC	Vendor	CS/UOS	Location
81920276	Black	702085405762	WB134-BLK	4/4	East
81920275	Natural Patina	702085400200	WB134	4/4	East

Handled Basket Variety pack

Handled Basket Variety pack in black finish features 2 each floral, daisy, and arch styles. Basket size 16" diameter x 9" deep - Height with handle attached 19"



Item #	Desc	UPC	Vendor	CS/UOS	Location
81920072	2 each handled	702085408572	BAVP102-BLK	6/6	East



French Hanging Basket With Coco Liner

Hanging Basket is 17" in diameter. Planting area is 12" diameter x 8" deep



Item #	Desc	UPC	Vendor	CS/UOS	Location
81920028	Natural Patina	702085400224	BA131	6/6	National
81920029	Black	702085405908	BA131-BLK	6/6	National



Moka Scratch Tall Pot (A)

Item #	Desc	UPC	Vendor	CS/UOS	Location
80620079	10.2" - 26cm	726232922698	M908CFZ	4/4	National

Moka Standard Terra Cotta Pot (B)

Moka Chocolate Terra Cotta Clay Tapered Planter. Features both rich color and design. Functional hole in the bottom allows for bottom watering.

Item #	Desc	UPC	Vendor	CS/UOS	Location
80620074	4.3" - 11cm	726232924838	0111CPZ	24/24	National
80620075	5.9" - 15cm	726232922612	0115CPZ	24/24	National
80620076	8.3" - 21cm	726232966012	M830CPZ	12/12	National
80620077	9.85" - 25cm	726232966005	M906CFZ	6/6	National

Imperial Hanging Basket with Coco Liner

16" diameter x 9" deep basket



Item #	Desc	UPC	Vendor	CS/UOS	Location
81920053	Black	702085405953	BA217-BLK	6/6	East

Moka Saucer (C)

Item #	Desc	UPC	Vendor	CS/UOS	Location
80620086	4.3" - 11cm	726232925583	8711CPZ	24/24	National
80620087	5.9" - 15cm	726232925668	8715CPZ	24/24	National
80620088	6.7" - 17cm	726232633853	8717CPZ	24/24	National
80620089	8.3" - 21cm	726232633884	8721CPZ	24/24	National
80620090	9.1" - 23cm	726232620976	8723CPZ	16/16	National
80620092	11.4" - 29cm	726232492504	8729CPZ	9/9	National

Solera Basket With Coco Liner

Handle on handled basket is removable for easy planting. Height with handle is 19" - Planting area 15" x 8" - Two colors to choose from black or natural patina. Hanging basket planting area 15" x 8" available in one color, black



Item #	Desc	UPC	Vendor	CS/UOS	Location
81920037	Black Hanging Basket	702085405922	BA203-BLK	6/6	East
81920043	Black Handle Basket	702085405946	BA206-BLK	6/6	East
81920042	Patina Handle Basket	702085402068	BA206	6/6	East

Moka Cono (D)

Item #	Desc	UPC	Vendor	CS/UOS	Location
80620069	6.3" - 16cm	726232952527	M895CPZ	24/24	National
80620071	10.2" - 26cm	726232925194	3R26CFZ	6/6	National
80620004	12.2" - 31cm	726232455554	3R310FZ	4/4	National

Moka Smooth Clay Bowl (E)

Item #	Desc	UPC	Vendor	CS/UOS	Location
80620083	9.06" - 23cm	726232925064	M910CFZ	6/6	National
80620084	10.6" - 27cm	726232925101	M911CFZ	3/3	National
80620085	12.6" - 32cm	726232925125	M912CFZ	3/3	East

2024



Standard Terra Cotta Pot (A)

Features both traditional color and design. Functional hole in the bottom allows for bottom watering. Contributes to the health of your plant.

Item #	Desc	UPC	Vendor	CS/UOS	Location
80620948	2.8"	726232010609	01070FZ	48/48	National
80620008	4.3" - 11cm	726232011002	01110PZ	24/24	National
80620009	5.9" - 15cm	726232011408	M8090PZ	20/20	National
80620010	6.3" - 16cm	726232011507	M8700PZ	20/20	National
80620011	8.3" - 21cm	726232012009	M8300PZ	12/12	National
80620012	9.1" - 23cm	726232012207	01230PZ	6/6	National
80620847	10" - 26cm	726232012603	M9510PZ	6/6	National
80620848	12.2" - 31cm	726232013006	M9060PZ	3/3	National
80620849	13.8" - 35cm	726232013402	M9520PZ	2/2	National

Standard Terra Cotta Saucer (B)

Item #	Desc	UPC	Vendor	CS/UOS	Location
80620758	2.8" - 7cm	726232240716	87071PZ	18/18	National
80620058	4.3" - 11cm	726232241010	M8190PZ	24/24	National
80620059	5.9" - 15cm	726232241416	M8210PZ	20/20	National
80620060	6.7" - 17cm	726232241614	M8220PZ	20/20	National
80620061	7.5" - 19cm	726232241812	M8230PZ	16/16	National
80620062	8.3" - 21cm	726232242017	M8240PZ	12/12	National
80620064	9.8" - 25cm	726232242413	87250PZ	12/12	National
80620065	11.4" - 29cm	726232242819	87290PZ	9/9	National
80620863	18.1" - 46cm	726232244516	87460PZ	3/3	National

Garden Bell Pot (C)

Item #	Desc	UPC	Vendor	CS/UOS	Retail
80620226	8.3" - 21cm	726232183730	2Q210PZ	12/12	National

Orchid Pot (D)

The pot features durable clay construction and has drainage holes that prevent the buildup of excess water.

Item #	Desc	UPC	Vendor	CS/UOS	Location
80620233	6.7" - 17cm	726232761709	M8990PZ	24/24	National
80620234	8.3" - 21cm	726232762102	M9030PZ	12/12	National

Border Cylinder (E)

Item #	Desc	UPC	Vendor	CS/UOS	Location
80620756	3.1" - 8cm	726232110705	0P080PZ	24/24	National
80620034	4.7" - 12cm	726232005599	0P120PZ	16/16	National
80620035	5.5" - 14cm	726232111207	0P140PZ	20/20	National

Azalea Terra Cotta Pot (F)

Features both traditional color and design. Functional hole in the bottom allows for bottom watering. Contributes to the health of your plant.

Item #	Desc	UPC	Vendor	CS/UOS	Location
80620017	4.3" - 11cm	726232021001	M8130PZ	24/24	National
80620018	6.7" - 17cm	726232021605	M8140PZ	20/20	National
80620020	8.3" - 21cm	726232022008	M8370PZ	12/12	National
80620850	10" - 26cm	726232022602	02270PZ	5/5	National

Standard Pot Mini (G)

Item #	Desc	UPC	Vendor	CS/UOS	Location
80620498	1.6" - 4cm	726232010302	01040FZ	48/48	National
80620499	2.0" - 5cm	726232010401	01050FZ	48/48	National
80620504	3.5" - 9cm	726232013815	01090PZ	36/36	National

Cabo Planter



Item #	Desc	UPC	Vendor	CS/UOS	Location
80620227	4.7"	726232330936	4L120PZ	16/16	National
80620228	6.7"	726232330950	4L170PZ	12/12	National
80620229	7.5"	726232330974	4L190PZ	6/6	National
80620230	10.2"	726232330998	4L260PZ	4/4	National
80620231	11.8"	726232329602	4L300PZ	2/2	National

Cambria Pallet
21"14"19"13"
White & Blue



Item #	Desc	Vendor	CS/UOS	Location
80620818	24 pieces	MIX3	1/1	National



Small 3E Assortment

Item #	Desc	Vendor	CS/UOS	Location
80620825	97 pieces	SMALL 3E	1/1	East



Mixed Seed Planters

Item #	Desc	Vendor	CS/UOS	Location
80620820	54 pieces	32M405	1/1	East



Delisle Secchi-Ganau Mix Pallet

Item #	Desc	UPC	Vendor	CS/UOS	Location
80620945	48 pieces	191942025425	32M355	1/1	National



Acampe Pallet

Item #	Desc	Vendor	CS/UOS	Location
80620817	8pc 18" 15" 13" Blue & Green	MIX4	1/1	East



Succulent Planters Assortment

Item #	Desc	UPC	Vendor	CS/UOS	Location
80620966	Box 2	191942056771	32M409F	1/1	East



Mix 4 Assortment

Item #	Desc	Vendor	CS/UOS	Location
80620823	36 pieces	MIX4	1/1	East



Blanc Teneriffe Rook Planters

Item #	Desc	UPC	Vendor	CS/UOS	Location
80620997B	54 Piece Blue/Cream		32M360	1/1	East



Diamond Bassac Pictou Mead Mixed

Item #	Desc	UPC	Vendor	CS/UOS	Location
80621002	84 Piece	191942057280	32M417	1/1	East



Plant Dolly

Move both small and large plants indoors and outdoors with ease. Rubber wheels and steel casters. (The 16" has 5 wheels)

Item #	Desc	UPC	Vendor	CS/UOS	Location
82420033	12" Black w/ no hole	837839003212	DEV3012B	8/8	National
82420034	12" Espresso w/ no hole	837839003335	DEV3012EX	8/8	National
82420035	12" Gray Mist w/ no hole	837839003304	DEV3012GM	8/8	National
82420032	12" Terra Cotta w/ no hole	837839003069	DEV3012	8/8	National
82420024	16" Black w/ no hole	837839003410	DEV3000BNH	8/8	National
82420029	16" Terra Cotta w/ no hole	837839003403	DEV3000PNH	8/8	National
82420023	16" Black	837839003229	DEV3000B	8/8	National
82420025	16" Espresso	837839009917	DEV3000EX	8/8	National
82420026	16" Gray Mist	837839003311	DEV3000GM	8/8	National
82420028	16" Terra Cotta	837839003007	DEV3000P	8/8	National



Whiskey Barrel Planter

Well-constructed planter with a stained finish. Planter tightens naturally when filled with dirt and water. DeVault Enterprises 6 Piece Wooden Whiskey Barrel Planter Set includes 6 different-sized planters to accommodate different-sized plants. Constructed of weatherproof fir, these planters will look great in your yard or on your deck.

10"x10"x8" | 12"x12"x10" | 15"x15"x12"
17"x17"x14" | 20"x20"x15" | 23"x23"x17"

Item #	Desc	UPC	Vendor	CS/UOS	Location
82420071	Large	837839007128	DEVBP213.01	5/5	National
82420058	Set of 6	837839002086	DEVBP208	1/1	National



Oval Planter

These Oval Wooden Planters made from high quality wood, using tongue and groove construction techniques and reinforced with steel bands for extra stability. Featuring two steel handles, these wooden planters are also weather resistant. When you add dirt and plants or flowers then water, the planters will expand for a tight fit. Wooden Oval Planters 2 sets of 4 per case.

12"x7"x5" | 15"x9"x6" | 18"x11"x7" | 20"x12"x8"

Item #	Desc	UPC	Vendor	CS/UOS	Location
82420057	Small Only	837839006053	DEVBP214.01	6/6	National
82420049	Set of 4	837839002147	DEVBP214	1/1	National



MORE OPTIONS TO

CONTAIN YOURSELF

Complete your retail offering with our full lineup of greenhouse and nursery containers. Griffin proudly represents top manufacturers including HC Companies (Dillen-ITML), T.O. Plastics, Nursery Supplies, Classic Home & Garden and many others.

Item	Size	Item #
Dillen 6" azalea pot, green	560/carton	48-7421
Kord 8" traditional bulb pan, green	96/case	50-1696
NSI 400C 1-gallon custom, black	92/stack	41PT400CN2
NSI 1200C 3-gallon custom, black	56/stack	41PT1200CN3

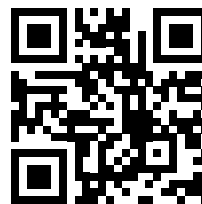



Leader in Horticultural Containers

Tahoe Planter

Made from durable and unique proprietary blend of resins. The texture gives the illusion of aged wood without the fragility and weight. Earth tone colors of birch white and falcon brown work well in all seasons with a larger variety of plantings and arrangements. Features a removable drain plug. Great for indoor or outdoor use.



Item #	Desc	UPC	Vendor	CS/UOS	Location
80282163	15" Slate	770932836120	KTS15000A55	4/4	National



Sand Stone

Venetian Flower Box

Add beauty to balconies, patios, walls, fences, and window sills with the durable, light-weight Venetian Window Box. Includes removable drain plugs.

Item #	Desc	UPC	Vendor	CS/UOS	Location
80280036	18" Clay	032903128185	VNP18000E35	6/6	National
80280043	24" Clay	032903128246	VNP24000E35	6/6	National
80280044	24" Sand Stone	032903453423	VNP24000A34	6/6	National
80280051	30" Clay	032903128307	VNP30000E35	6/6	National

Terrazzo Saucer

Elegant and resilient, Terrazzo round planters combine the look of authentic Italian terra cotta with the benefits of resin. Unique bottom-channel design provides excellent drainage.



Terra Cotta



Black Granite

Item #	Desc	UPC	Vendor	CS/UOS	Location
80282000	42" Terra Cotta	770932835178	STZ42000E35	1/1	East
80282001	42" Black Granite	770932835185	STZ42000G21	1/1	East



Venetian Box Tray

Add beauty to your window box with this window box saucer.

Item #	Desc	UPC	Vendor	CS/UOS	Location
80280024	24"	032903123241	SVN24000E35	6/6	National

Nursery Containers

These pots are mainstay in the lawn and garden industry. Great for all your potting needs. Strong rims for handling. Includes drainage holes.



Item #	Desc	UPC	Vendor	CS/UOS	Location
80282009	#2 Black	56554205057	NSB002G0G18	50/50	National
80282010	#3 Black	56554105050	NSR003G0G18	25/25	National

Deck Rail Planter

The deck rail box is designed with thick, durable plastic wall construction. Features easy to remove drain plugs for maximum drainage. Earth tone color choices perfect for outdoor spaces.

24" L x 12" W. Fits both 2" x 4" and 2" x 6" deck rails.

Sandstone



Chocolate



Clay



Black

Item #	Desc	UPC	Vendor	CS/UOS	Location
80282114	24" - Sandstone	032903914856	SPX24DB0A34	5/5	National
80290131	24" - Chocolate	770932002693	SPX24DB0E21	5/5	National
80282116	24" - Clay	032903914849	SPX24DB0E35	5/5	National
80282117	24" - Black	770932836861	SPX24DB0G18	5/5	National

Olympia Urn

Inspired by ancient urns, the elegant rings and majestic contours of the Olympia Urn create the ideal planter to add to any outdoor setting. Works well on driveways, flanking a garage door, or an exterior door. Timeless design with long lasting plastic construction.



Item #	Desc	UPC	Vendor	CS/UOS	Location
80290210	16"	56554731051	RUA16000G18	8/8	National

Jack O'Lantern Pot

Happy and scary face painted on either side, great for the fall season. Fiber Clay with drainage holes.



Item #	Desc	UPC	Vendor	CS/UOS	Location
80281501	10"	032903915167	PPF10001Y28C008	8/8	National



Leader in Horticultural Containers



Panterra Oval Pot

These distinctive oval shaped planters have a textured finish and are a popular choice for colorful flowering arrangements, herbs, annuals and tropical plants.

Item #	Desc	UPC	Vendor	CS/UOS	Location
80280785	20" Clay	770932702036	PAP20000E22	24/24	National
80280784	20" Green	770932702005	PAP20000B71	24/24	National



Panterra Saucer

Made from plastic, these containers are very durable and lightweight. This makes them great for performing outdoor container gardening on your patio, porch, or deck. These trays will not crack nor color-fade over time.

Item #	Desc	UPC	Vendor	CS/UOS	Location
80280768	6"	770932786036	SPN06000E22	18/18	National
80280771	8"	770932788030	SPN08000E22	18/18	National



Caribbean Pot

Capture the soul and style of the Caribbean with these light-weight, durable Caribbean Planters. Removable drain plugs for indoor or outdoor use. Planters can be partnered with Classic Saucers. Contoured base protects plants from excess water.

Item #	Desc	UPC	Vendor	CS/UOS	Location
80281832	12"	032903123128	CNA12000E35	12/12	National

Garden Bowl

Perfect for shallow rooted plantings and colorful annuals. For maximum appeal, add this Garden Bowl to tables, ledges, stands, or any kind of posts. Removable drain plugs allow for indoor or outdoor use. Compatible with Classic Saucers.

Item #	Desc	UPC	Vendor	CS/UOS	Location
80280022	12" Clay	032903127126	GAB12000E35	12/12	National
80280032	14" Clay	032903127140	GAB14000E35	12/12	National
80290111	18" Chocolate	032903003130	GAB18000E21	6/6	National

Charcoal Aspen Planters

Fiber glass construction is more rigid than plastic and less breakable than ceramic. Contemporary design with grooved texture and globe shape. Durable and weather resistant.



Item #	Desc	UPC	Vendor	CS/UOS	Location
80282394	15", 15", & 17.5" 3 pack	770932839794	ANP00001A39	3/3	National
80282383	12"	770932839107	ANP12000A39	1/1	National

Avino Square Planter

These plastic containers are very durable and lightweight. This makes them great for performing outdoor gardening on your patio, porch, or deck. These containers will not crack nor color-fade over time.



Item #	Desc	UPC	Vendor	CS/UOS	Location
80290179	13" Oxidized Black	056554105807	AOS13000P29	6/6	National
80290219	16" Oxidized Black	056554105814	AOS16000P29	6/6	National

Green Grower Pot

An economical poly growing pot for new plants and cuttings. Ideal for a wide variety of planting applications. Durable and long lasting.



Item #	Desc	UPC	Vendor	CS/UOS	Location
80281519	8"	770932099006	AZE08000B71	18/18	National

Eclipse Square Planter

These square planters come in several sizes and are great for indoor houseplants, as well as outdoor gardening on your patio, porch or deck. Use them to grow vegetables, flowers, herbs, snake plants and more.



Item #	Desc	UPC	Vendor	CS/UOS	Location
80282952	6" Cottage Stone	770932847515	ECP06005A02	28/28	National
80282953	6" Black	770932847485	ECP06005G18	28/28	National
80282954	8" Cottage Stone	770932847553	ECP08005A02	24/24	National
80282955	8" Black	770932847522	ECP08005G18	24/24	National
80282956	10" Cottage Stone	770932847591	ECP10050A02	20/20	National
80282957	10" Black	770932847560	ECP10050G18	20/20	National



Leader in Horticultural Containers



Capri Bowl

Get the look of ceramic and concrete, without the fragility, with these attractive and modern succulent planters made of durable plastic. The planters feature a drain hole for proper succulent care.

Item #	Desc	UPC	Vendor	CS/UOS	Location
80282501	6" Vanilla Bisque	770932840653	CSB06000A58	20/20	National
80282502	6" Artisan Taupe	770932840677	CSB06000E67	20/20	National
80282503	6" Faux Concrete	770932840691	CSB06000G28	20/20	National
80282504	8" Vanilla Bisque	770932840660	CSB08000A58	20/20	National
80282505	8" Artisan Taupe	770932840684	CSB08000E67	20/20	National
80282506	8" Faux Concrete	770932840707	CSB08000G28	20/20	National
80282897	8" Concrete/Copper	770932841377	CSB08001K-20C020LRCOZ	20/20	National



Sprite Succulent Pot

Plastic succulent planter has the look of ceramic and concrete without the fragility. Features a drain hole for proper succulent drainage and care.

Item #	Desc	UPC	Vendor	CS/UOS	Location
80282495	2.5" Vanilla Bisque	770932840790	SSP02500A58	20/20	National
80282496	2.5" Artisan Taupe	770932840813	SSP02500E67	20/20	National
80282497	2.5" Faux Concrete	770932840837	SSP02500G28	20/20	National
80282851	2.5" Faux Turquoise	770932844149	SSP02500K22	20/20	National
80282850	2.5" Blush	770932844125	SSP02500K21	20/20	National
80282498	3" Vanilla Bisque	770932840806	SSP03000A58	20/20	National
80282499	3" Artisan Taupe	770932840820	SSP03000E67	20/20	National
80282500	3" Faux Concrete	770932840844	SSP03000G28	20/20	National
80282898	3" Faux Concrete/Copper	770932841360	SSP03000K-20C040LRCOY	40/40	National
80282859	7" Vanilla Bisque	770932844057	SSP07000A58	12/12	National

Curio Planter w/ Geometric Stand

Contemporary, indoor, decorative planter that will brighten any room. The included reversible plastic stand painted with a metallic finish provides the ability to display this planter in multiple ways. Perfect for center pieces, book shelves, windows and counter tops. Recommended for succulents, herbs, tropical plants and other indoor varieties.



Item #	Desc	UPC	Vendor	CS/UOS	Location
80282603	4" Blush	770932844200	CUP04000K21	10/10	National
80282604	4" Lavender	770932844248	CUP04000K23	10/10	National
80282605	4" Cottage Stone	770932844224	CUP04000K25	10/10	National
80282606	4" Honey	770932844262	CUP04000K26	10/10	National
80282607	5" Artisan Taupe	770932844934	CUP05000E67	10/10	National
80282608	5" Blush	770932844965	CUP05000K21	10/10	National
80282609	5" Lavender	770932844651	CUP05000K23	10/10	National
80282610	5" Cottage Stone	770932844996	CUP05000K25	10/10	National
80282611	5" Honey	770932844644	CUP05000K26	10/10	National



Orion Pot

Modern two-toned faux finish planter with contemporary raised base design. Self watering two-piece planter.

Item #	Desc	UPC	Vendor	CS/UOS	Location
80282900	6"-Sage	770932845931	ORP06000K29	16/16	National
80282899	6"-Greige	770932845900	ORP06000K28	16/16	National
80282901	6"-Clay	770932845962	ORP06000K30	16/16	National
80282903	8"-Sage	770932846020	ORP08000K29	12/12	National
80282902	8"-Greige	770932845993	ORP08000K28	12/12	National
80282904	8"-Clay	770932846051	ORP08000K30	12/12	National
80282906	10" -Sage	770932846112	ORP10000K29	12/12	National
80282905	10" -Greige	770932846082	ORP10000K28	12/12	National
80282907	10" -Clay	770932846143	ORP10000K30	12/12	National

PRIMA SERIES

These plastic containers are very durable and lightweight. This makes them great for performing outdoor gardening on your patio, porch, or deck. These containers will not crack nor color-fade over time.



Leader in Horticultural Containers



2024

8" Planters

Item #	Desc	UPC	Vendor	CS/UOS	Location
80282661	8"-Sand Stone	770932842497	PCP08005A34	24/24	National
80282665	8"-Dusty Teal	770932842091	PCP08005DE1	24/24	National
80282667	8"-Chocolate	770932841933	PCP08005E21	24/24	National
80282662	8"-Warm Gray	770932842572	PCP08005A42	24/24	National
80282664	8"-Honey	770932842251	PCP08005CXX	24/24	National
80282666	8"-Twilight Blue	770932842411	PCP08005DE6	24/24	National
80282663	8"-Evergreen	770932842176	PCP08005B91	24/24	National
80282668	8"-Cappuccino	770932841858	PCP08005E29	24/24	National
80282669	8"-Terra Cotta	770932842015	PCP08005E35	24/24	National
80282670	8"-Marsala	770932842336	PCP08005FD2	24/24	National
80282671	8"-Black	770932841773	PCP08005G18	24/24	National

8" Saucers

Item #	Desc	UPC	Vendor	CS/UOS	Location
80282749	8"-Sand Stone	770932843371	PCS08005A34	24/24	East
80282751	8"-Evergreen	770932843050	PCS08005B91	24/24	East
80282752	8"-Honey	770932843135	PCS08005CXX	24/24	East
80282754	8"-Twilight Blue	770932843296	PCS08005DE6	24/24	East
80282750	8"-Warm Gray	770932843456	PCS08005A42	24/24	East
80282757	8"-Terra Cotta	770932842893	PCS08005E35	24/24	East
80282753	8"-Dusty Teal	770932842978	PCS08005DE1	24/24	East
80282755	8"-Chocolate	770932842817	PCS08005E21	24/24	East
80282756	8"-Cappuccino	770932842732	PCS08005E29	24/24	East
80282758	8"-Marsala	770932843210	PCS08005FD2	24/24	East
80282759	8"-Black	770932842657	PCS08005G18	24/24	East

6" Planters

Item #	Desc	UPC	Vendor	CS/UOS	Location
80282654	6"-Dusty Teal	770932842084	PCP06005DE1	24/24	National
80282655	6"-Terra Cotta	770932842404	PCP06005DE6	24/24	National
80282650	6"-Sand Stone	770932842480	PCP06005A34	24/24	National
80282651	6"-Warm Gray	770932842565	PCP06005A42	24/24	National
80282653	6"-Honey	770932842244	PCP06005CXX	24/24	National
80282657	6"-Cappuccino	770932841841	PCP06005E29	24/24	National
80282659	6"-Marsala	770932842329	PCP06005FD2	24/24	National
80282660	6"-Black	770932841766	PCP06005G18	24/24	National
80282652	6"-Evergreen	770932842169	PCP06005B91	24/24	National
80282656	6"-Chocolate	770932841926	PCP06005E21	24/24	National
80282658	6"-Terra Cotta	770932842008	PCP06005E35	24/24	National

6" Saucers

Item #	Desc	UPC	Vendor	CS/UOS	Location
80282743	6"-Twilight Blue	770932843289	PCS06005DE6	24/24	East
80282742	6"-Dusty Teal	770932842961	PCS06005DE1	24/24	East
80282739	6"-Warm Gray	770932843449	PCS06005A42	24/24	East
80282741	6"-Honey	770932843128	PCS06005CXX	24/24	East
80282745	6"-Cappuccino	770932842725	PCS06005E29	24/24	East
80282746	6"-Terra Cotta	770932842886	PCS06005E35	24/24	East
80282748	6"-Black	770932842640	PCS06005G18	24/24	East
80282738	6"-Sand Stone	770932843364	PCS06005A34	24/24	East
80282740	6"-Evergreen	770932843043	PCS06005B91	24/24	East
80282744	6"-Chocolate	770932842800	PCS06005E21	24/24	East
80282747	6"-Marsala	770932843203	PCS06005FD2	24/24	East





Leader in Horticultural Containers



12" Planters

Item #	Desc	UPC	Vendor	CS/UOS	Location
80282688	12"-Twilight Blue	770932842435	PCP12005DE6	12/12	National
80282683	12"-Sand Stone	770932842510	PCP12005A34	12/12	National
80282685	12"-Evergreen	770932842190	PCP12005B91	12/12	National
80282686	12"-Honey	770932842275	PCP12005CXX	12/12	National
80282687	12"-Teal	770932842114	PCP12005DE1	12/12	National
80282690	12"-Cappuccino	770932841872	PCP12005E29	12/12	National
80282684	12"-Warm Gray	770932842596	PCP12005A42	12/12	National
80282689	12"-Chocolate	770932841957	PCP12005E21	12/12	National
80282693	12"-Black	770932841797	PCP12005G18	12/12	National
80282691	12"-Terra Cotta	770932842039	PCP12005E35	12/12	National
80282692	12"-Marsala	770932842350	PCP12005FD2	12/12	National

10" Planters

Item #	Desc	UPC	Vendor	CS/UOS	Location
80282675	10"-Honey	770932842268	PCP10005CXX	12/12	National
80282677	10"-Twilight Blue	770932842428	PCP10005DE6	12/12	National
80282673	10"-Warm Gray	770932842589	PCP10005A42	12/12	National
80282682	10"-Black	770932841780	PCP10005G18	12/12	National
80282672	10"-Sand Stone	770932842503	PCP10005A34	12/12	National
80282674	10"-Evergreen	770932842183	PCP10005B91	12/12	National
80282676	10"-Dusty Teal	770932842107	PCP10005DE1	12/12	National
80282678	10"-Chocolate	770932841940	PCP10005E21	12/12	National
80282679	10"-Cappuccino	770932841865	PCP10005E29	12/12	National
80282680	10"-Terra Cotta	770932842022	PCP10005E35	12/12	National
80282681	10"-Marsala	770932842343	PCP10005FD2	12/12	National

12" Saucers

Item #	Desc	UPC	Vendor	CS/UOS	Location
80282776	12"-Twilight Blue	770932843319	PCS12005DE6	12/12	East
80282778	12"-Cappuccino	770932842756	PCS12005E29	12/12	East
80282775	12"-Dusty Teal	770932842992	PCS12005DE1	12/12	East
80282779	12"-Terra Cotta	770932842916	PCS12005E35	12/12	East
80282781	12"-Black	770932842671	PCS12005G18	12/12	East
80282771	12"-Sand Stone	770932843395	PCS12005A34	12/12	East
80282772	12"-Warm Gray	770932843470	PCS12005A42	12/12	East
80282773	12"-Evergreen	770932843074	PCS12005B91	12/12	East
80282774	12"-Honey	770932843159	PCS12005CXX	12/12	East
80282777	12"-Chocolate	770932842831	PCS12005E21	12/12	East
80282780	12"-Marsala	770932843234	PCS12005FD2	12/12	East

10" Saucers

Item #	Desc	UPC	Vendor	CS/UOS	Location
80282763	10"-Honey	770932843142	PCS10005CXX	12/12	East
80282765	10"-Twilight Blue	770932843302	PCS10005DE6	12/12	East
80282761	10"-Warm Gray	770932843463	PCS10005A42	12/12	East
80282767	10"-Cappuccino	770932842749	PCS10005E29	12/12	East
80282770	10"-Black	770932842664	PCS10005G18	12/12	East
80282760	10"-Sand Stone	770932843388	PCS10005A34	12/12	East
80282762	10"-Evergreen	770932843067	PCS10005B91	12/12	East
80282764	10"-Dusty Teal	770932842985	PCS10005DE1	12/12	East
80282766	10"-Chocolate	770932842824	PCS10005E21	12/12	East
80282768	10"-Terra Cotta	770932842909	PCS10005E35	12/12	East
80282769	10"-Marsala	770932843227	PCS10005FD2	12/12	East





Leader in Horticultural Containers



2024



16" Planters

Item #	Desc	UPC	Vendor	CS/UOS	Location
80282705	16"-Sand Stone	770932842534	PCP16005A34	12/12	National
80282706	16"-Warm Gray	770932842619	PCP16005A42	12/12	National
80282707	16"-Evergreen	770932842213	PCP16005B91	12/12	National
80282708	16"-Honey	770932842299	PCP16005CXX	12/12	National
80282709	16"-Dusty Teal	770932842138	PCP16005DE1	12/12	National
80282710	16"-Twilight Blue	770932842459	PCP16005DE6	12/12	National
80282711	16"-Chocolate	770932841971	PCP16005E21	12/12	National
80282712	16"-Cappuccino	770932841896	PCP16005E29	12/12	National
80282713	16"-Terra Cotta	770932842053	PCP16005E35	12/12	National
80282714	16"-Marsala	770932842374	PCP16005FD2	12/12	National
80282715	16"-Black	770932841810	PCP16005G18	12/12	National

14" Planters

Item #	Desc	UPC	Vendor	CS/UOS	Location
80282694	14"-Sand Stone	770932842527	PCP14005A34	12/12	National
80282695	14"-Warm Gray	770932842602	PCP14005A42	12/12	National
80282696	14"-Evergreen	770932842206	PCP14005B91	12/12	National
80282698	14"-Dusty Teal	770932842121	PCP14005DE1	12/12	National
80282700	14"-Chocolate	770932841964	PCP14005E21	12/12	National
80282697	14"-Honey	770932842282	PCP14005CXX	12/12	National
80282699	14"-Twilight Blue	770932842442	PCP14005DE6	12/12	National
80282704	14"-Black	770932841803	PCP14005G18	12/12	National
80282701	14"-Cappuccino	770932841889	PCP14005E29	12/12	National
80282702	14"-Terra Cotta	770932842046	PCP14005E35	12/12	National
80282703	14"-Marsala	770932842367	PCP14005FD2	12/12	National

16" Saucers

Item #	Desc	UPC	Vendor	CS/UOS	Location
80282799	16"-Chocolate	770932842855	PCS16005E21	12/12	East
80282793	16"-Sand Stone	770932843418	PCS16005A34	12/12	East
80282794	16"-Warm Gray	770932843494	PCS16005A42	12/12	East
80282795	16"-Evergreen	770932843098	PCS16005B91	12/12	East
80282796	16"-Honey	770932843173	PCS16005CXX	12/12	East
80282797	16"-Dusty Teal	770932843012	PCS16005DE1	12/12	East
80282798	16"-Twilight Blue	770932843333	PCS16005DE6	12/12	East
80282800	16"-Cappuccino	770932842770	PCS16005E29	12/12	East
80282801	16"-Terra Cotta	770932842930	PCS16005E35	12/12	East
80282802	16"-Marsala	770932843258	PCS16005FD2	12/12	East
80282803	16"-Black	770932842695	PCS16005G18	12/12	East

14" Saucers

Item #	Desc	UPC	Vendor	CS/UOS	Location
80282792	14"-Black	770932842688	PCS14005G18	12/12	East
80282782	14"-Sand Stone	770932843401	PCS14005A34	12/12	East
80282783	14"-Warm Gray	770932843487	PCS14005A42	12/12	East
80282784	14"-Evergreen	770932843081	PCS14005B91	12/12	East
80282785	14"-Honey	770932843166	PCS14005CXX	12/12	East
80282786	14"-Dusty Teal	770932843005	PCS14005DE1	12/12	East
80282787	14"-Twilight Blue	770932843326	PCS14005DE6	12/12	East
80282788	14"-Chocolate	770932842848	PCS14005E21	12/12	East
80282789	14"-Cappuccino	770932842763	PCS14005E29	12/12	East
80282790	14"-Terra Cotta	770932842923	PCS14005E35	12/12	East
80282791	14"-Marsala	770932843241	PCS14005FD2	12/12	East





Leader in Horticultural Containers



24" Planters

Item #	Desc	UPC	Vendor	CS/UOS	Location
80282733	24"-Chocolate	770932841995	PCP24005E21	6/6	National
80282734	24"-Cappuccino	770932841919	PCP24005E29	6/6	National
80282727	24"-Sand Stone	770932842558	PCP24005A34	6/6	National
80282728	24"-Warm Gray	770932842633	PCP24005A42	6/6	National
80282729	24"-Evergreen	770932842237	PCP24005B91	6/6	National
80282730	24"-Honey	770932842312	PCP24005CXX	6/6	National
80282731	24"-Dusty Teal	770932842152	PCP24005DE1	6/6	National
80282732	24"-Twilight Blue	770932842473	PCP24005DE6	6/6	National
80282735	24"-Terra Cotta	770932842077	PCP24005E35	6/6	National
80282736	24"-Marsala	770932842398	PCP24005FD2	6/6	National
80282737	24"-Black	770932841834	PCP24005G18	6/6	National

20" Planters

Item #	Desc	UPC	Vendor	CS/UOS	Location
80282716	20"-Sand Stone	770932842541	PCP20005A34	6/6	National
80282717	20"-Warm Gray	770932842626	PCP20005A42	6/6	National
80282718	20"-Evergreen	770932842220	PCP20005B91	6/6	National
80282719	20"-Honey	770932842305	PCP20005CXX	6/6	National
80282720	20"-Dusty Teal	770932842145	PCP20005DE1	6/6	National
80282721	20"-Twilight Blue	770932842466	PCP20005DE6	6/6	National
80282722	20"-Chocolate	770932841988	PCP20005E21	6/6	National
80282723	20"-Cappuccino	770932841902	PCP20005E29	6/6	National
80282724	20"-Terra Cotta	770932842060	PCP20005E35	6/6	National
80282725	20"-Marsala	770932842381	PCP20005FD2	6/6	National
80282726	20"-Black	770932841827	PCP20005G18	6/6	National

24" Saucers

Item #	Desc	UPC	Vendor	CS/UOS	Location
80282815	24"-Sand Stone	770932843432	PCS24005A34	6/6	East
80282816	24"-Warm Gray	770932843517	PCS24005A42	6/6	East
80282817	24"-Evergreen	770932843111	PCS24005B91	6/6	East
80282818	24"-Honey	770932843197	PCS24005CXX	6/6	East
80282819	24"-Dusty Teal	770932843036	PCS24005DE1	6/6	East
80282820	24"-Twilight Blue	770932843357	PCS24005DE6	6/6	East
80282821	24"-Chocolate	770932842879	PCS24005E21	6/6	East
80282822	24"-Cappuccino	770932842794	PCS24005E29	6/6	East
80282823	24"-Terra Cotta	770932842954	PCS24005E35	6/6	East
80282824	24"-Marsala	770932843272	PCS24005FD2	6/6	East
80282825	24"-Black	770932842718	PCS24005G18	6/6	East

20" Saucers

Item #	Desc	UPC	Vendor	CS/UOS	Location
80282804	20"-Sand Stone	770932843425	PCS20005A34	6/6	East
80282805	20"-Warm Gray	770932843500	PCS20005A42	6/6	East
80282806	20"-Evergreen	770932843104	PCS20005B91	6/6	East
80282807	20"-Honey	770932843180	PCS20005CXX	6/6	East
80282808	20"-Dusty Teal	770932843029	PCS20005DE1	6/6	East
80282809	20"-Twilight Blue	770932843340	PCS20005DE6	6/6	East
80282810	20"-Chocolate	770932842862	PCS20005E21	6/6	East
80282811	20"-Cappuccino	770932842787	PCS20005E29	6/6	East
80282812	20"-Terra Cotta	770932842947	PCS20005E35	6/6	East
80282813	20"-Marsala	770932843265	PCS20005FD2	6/6	East
80282814	20"-Black	770932842701	PCS20005G18	6/6	East





Deco Faceted Bowl

Get the look of ceramic and concrete, without the fragility, with these uniquely designed succulent planters made of durable plastic. The planters feature a drain hole for proper succulent care. The deco faceted bowls come in 6" or 8" - perfect for multi-plantings. The planters coordinate with our complete line of succulent planters.

Item #	Desc	UPC	Vendor	CS/UOS	Location
80282488	6" Artisan Taupe	770932840738	DFB06000E67	24/24	National
80282489	6" Faux Concrete	770932840752	DFB06000G28	24/24	National
80282491	8" Artisan Taupe	770932840745	DFB08000E67	24/24	National
80282492	8" Faux Concrete	770932840769	DFB08000G28	24/24	National
80282490	8" Vanilla Bisque	770932840721	DFB08000A58	24/24	National

8" Pixie Succulent Stacking Planter



Mini stacking planter includes three planting layers and a saucer to protect surfaces. Includes a drain hole in each cup on every level for proper succulent care. Holds a minimum of 10 planted succulents. Coordinates with our complete line of succulent planters sold separately.



Vanilla Bisque

Item #	Desc	UPC	Vendor	CS/UOS	Location
80282493	Vanilla Bisque	770932840776	SPP08000A58	4/4	National
80282494	Artisan Taupe	770932840783	SPP08000E67	4/4	National



Terrace Planter

Includes three planting layers and saucer for indoor and outdoor use. Each tier has a self-watering reservoir for even water distribution throughout each layer. Easy set-up, no hardware required. Plant annuals, perennials, herbs and more.



Warm Gray

Item #	Desc	UPC	Vendor	CS/UOS	Location
80282507	Warm Gray	770932840295	RZ.MT160A42	2/2	National
80282508	Iced Mocha	770932840301	RZ.MT160A57	2/2	National

8" Kaleidoscope Planter



Premium plastic modular planter can be displayed individually each planter has a removable saucer ideal for succulents or shallow rooted planted.

Item #	Desc	UPC	Vendor	CS/UOS	Location
80282643	Vanilla Bisque	770932844170	KDP08000A58	6/6	National

JACKSON POTTERY



Coastal Design Collection

Item #	Desc	Vendor	CS/UOS	Location
82220002	24 Pcs 8 sets	DG-PP-049	1/1	East



New Direction Collection

Item #	Desc	Vendor	CS/UOS	Location
82220001	24 Pcs 8 sets	DG-PP-127	1/1	East



Coastal Designs Collection

Item #	Desc	Vendor	CS/UOS	Location
82220003	24 Pcs 8 sets	DG-PP-050	1/1	East



ArtStone Ella Tall Planter

This Ella Tall Planter brings beauty to every doorway, patio, deck, backyard scene, the possibilities are endless. A deeper vessel allows for larger plants, trees and shrubbery to live in a healthier planted environment. All beautiful, all durable, all practical, both indoors and out.



Item #	Desc	UPC	Vendor	CS/UOS	Location
80250056	19.5" Black	026978351982	35198	2/2	East
80250761	19.5" Rust	026978351999	35199	2/2	East
80250656	19.5" Grey	026978351906	35190	2/2	East
80250348	27.5" Black	026978352781	35278	2/2	East

ArtStone Ella Square Planter

Best selling Ella planters offer a sleek profile with clean lines and neutral tones that accentuate any space, lending a modern look to all settings.



Item #	Desc	UPC	Vendor	CS/UOS	Location
80250767	10" Low Grey	026978361004	36100	5/5	East
80250353	10" Low Black	026978361080	36108	5/5	East
80250768	12" Low Grey	026978361202	36120	5/5	East
80250356	12" Low Black	026978361288	36128	5/5	East
80250651	6" Grey	026978350602	35060	10/10	East
80250034	6" Black	026978350688	35068	10/10	East
80250753	6" Rust	026978350695	35069	10/10	East
80250713	6" Mint	026978350664	35066	10/10	East
80250038	8" Black	026978350886	35088	10/10	East
80250652	8" Grey	026978350800	35080	10/10	East
80250843	8" White	026978350824	35082	10/10	East
80250714	8" Mint	026978350862	35086	10/10	East
80250653	10" Grey	026978351005	35100	5/5	East
80250755	10" Rust	026978351098	35109	5/5	East
80250715	10" Mint	026978351067	35106	5/5	East
80250042	10" Black	026978351081	35108	5/5	East
80250654	12" Grey	026978351203	35120	5/5	East
80250756	12" Rust	026978351296	35129	5/5	East
80250048	12" Black	026978351289	35128	5/5	East
80250716	12" Mint	026978351265	35126	5/5	East

Artstone Mini Planter

Great for herbs, succulents or small plants. Does not come with the Water-Minder feature. Comes in a case of 24 with an assortment of colors that include grey, white, mint and taupe (6 of each color). Dimensions: 3.12" dia x 3.5"h



Item #	Desc	UPC	Vendor	CS/UOS	Location
80250719	3"	10026978708103	70810	1/1	East

ArtStone Cache Pot Display

Comes with 24 pots, 6 of each color in Black, Grey, Terra Cotta and Taupe. A simple, practical drop in for growers and retailers.



Item #	Desc	UPC	Vendor	CS/UOS	Location
80250375	Neutral	10026978708028	70802	1/1	East



ArtStone Hanging Bowl

Unique hanging bowl for indoor or outdoor plants. Resin planters made with Artstone a superior blend of stone and resin. Self-watering reservoir conserves water

Item #	Desc	UPC	Vendor	CS/UOS	Location
80250750	10" Rust	026978321091	32109	5/5	East
80250749	10" Black	026978321084	32108	5/5	East
80250809	10" Grey	026978321008	32100	5/5	East
80250839	10" White	026978321022	32102	5/5	East



ArtStone Ella Wall Pot Displays

Includes 10 brown and 10 black wall pots. Water-Minder reservoir drainage system insert included. Case pack of 20 pieces - Ten of each color



Item #	Desc	UPC	Vendor	CS/UOS	Location
80250376	5.5"	126978708035	70803	1/1	East

ArtStone Napa Wall Pot Display

Includes 10 brown and 10 black 9 1/2" wall pots. Water-Minder reservoir drainage system insert included.



Item #	Desc	UPC	Vendor	CS/UOS	Location
80250453	9.5"	10026978708066	70806	1/1	East

Artstone Napa Planter

A sleek series in a variety of colors featuring Artstone resin and stone composite with a Water-Minder reservoir. Lightweight, durable, UV and frost resistant.



Item #	Desc	UPC	Vendor	CS/UOS	Location
80250736	6" Rust	026978080622	08062	10/10	East
80250738	8" Rust	026978080822	08082	10/10	East
80250737	8" Grey	026978080806	08080	10/10	East
80250735	6" Grey	026978080608	08060	10/10	East

ArtStone Napa Bowl

Napa bowls in 10" and 12" sizes make for stunning add-ons to the ArtStone line. Succulents, fairy gardens and small herbs fare well in these round planters. Think outside the box and use Napa bowls for fruits and veggies or a unique, great gift idea!



Item #	Desc	UPC	Vendor	CS/UOS	Location
80250745	10" Grey	026978311009	31100	5/5	East
80250331	10" Black	026978311085	31108	5/5	East
80250746	10" Rust	026978311092	31109	5/5	East
80250837	10" White	026978311023	31102	5/5	East
80250117	12" Black	026978311283	31128	5/5	East
80250747	12" Grey	026978311207	31120	5/5	East

Countryside Square Tub Planter

Countryside Tubs are designed with classic lines in a variety of shapes and sizes. Each planter features a deep root zone, helping plants stay vibrant and healthy. Drain holes and plugs included.



Item #	Desc	UPC	Vendor	CS/UOS	Location
80250100	14" White	026978261427	26142	10/10	East
80250862	14" Black	026978261489	26148	10/10	East
80250438	14" Brown	026978261434	26143	10/10	East
80250102	18" Terra Cotta	026978261854	26185	10/10	East
80250103	18" White	026978261823	26182	10/10	East

Classic Urn

The classic urn is the harbinger of modern day flower pots and still to this day, stands tall in heritage. It brings beauty to our plants and surroundings. Two-piece construction with optional punch-out drain holes and UV stable resin.



Item #	Desc	UPC	Vendor	CS/UOS	Location
80250107	14" Black	026978381484	38148	12/12	East
80250120	14" White	026978381422	38142	12/12	East
80250106	14" Stone	026978381460	38146	12/12	East
80250110	19" Black	026978381989	38198	6/6	East
80250108	19" White	026978381927	38192	6/6	East
80250109	19" Stone	026978381965	38196	6/6	East

Grecian Urn

Novelty's Grecian urns have a neoclassic style, always durable, fashionable and a must-have for deck, patio, pool-side and entry. Two-piece construction with optional punch-out drain holes and UV stable resin.



Item #	Desc	UPC	Vendor	CS/UOS	Location
80250058	12" Black	026978391285	39128	12/12	East
80250023	12" White	026978391223	39122	12/12	East
80250057	12" Stone	026978391261	39126	12/12	East
80250060	18" Black	026978391889	39188	6/6	East
80250024	18" White	026978391827	39182	6/6	East
80250059	18" Stone	026978391865	39186	6/6	East



Countryside Rail Planter

Classic look with deep planting area, drain plugs. Fits 2x4" and 2x6" railings.



Item #	Desc	UPC	Vendor	CS/UOS	Location
80250798	16" - White	026978261625	26162	4/4	East
80250863	16" Black	026978261687	26168	4/4	East
80250797	16" Sage	026978261601	26160	4/4	East
80250799	16" Brown	026978261632	26163	4/4	East
80250800	16" Terra Cotta	026978261656	26165	4/4	East
80250801	24" - Sage	026978262400	26240	4/4	East
80250802	24" - White	026978262424	26242	4/4	East
80250803	24" - Brown	026978262431	26243	4/4	East
80250804	24" - Terra Cotta	026978262455	26245	4/4	East

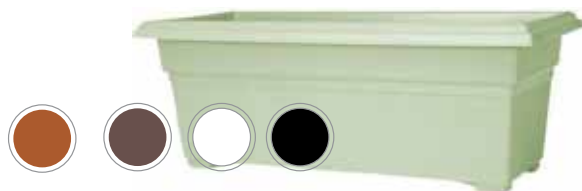

Countryside Flower Box Planter

Choose Countryside Flower Box Planters for a showy display under windows, on porches and decks, and along walkways. Drain holes and plugs included.

Item #	Desc	UPC	Vendor	CS/UOS	Location
80250430	18" Brown	026978161932	16193	10/10	East
80250429	18" Sage	026978161901	16190	10/10	East
80250252	18" Terra Cotta	026978161956	16195	10/10	East
80250251	18" White	026978161925	16192	10/10	East
80250858	18" Black	026978161987	16198	10/10	East
80250432	24" Brown	026978162434	16243	10/10	East
80250431	24" Sage	026978162403	16240	10/10	East
80250256	24" Terra Cotta	026978162458	16245	10/10	East
80250255	24" White	026978162427	16242	10/10	East
80250859	24" Black	026978162489	16248	10/10	East
80250424	24" Brown	026978102430	10243	10/10	East
80250433	30" Sage	026978163004	16300	10/10	East
80250260	30" Terra Cotta	026978163059	16305	10/10	East
80250259	30" White	026978163028	16302	10/10	East
80250434	30" Brown	026978163035	16303	10/10	East
80250264	36" Terra Cotta	026978163653	16365	10/10	East
80250263	36" White	026978163622	16362	10/10	East
80250861	36" Black	026978163684	16368	10/10	East



Polypro Plastic Planters & Liners

This polypro plastic flower box planter is made of a superior tough plastic blend with distinctive raised panel design. Sturdy planters for use alone, inside wooden box or inside wire hangers. Lightweight, durable, fade resistant plastic, coded for recycling. Knockout plugs for optional drainage.

Item #	Desc	UPC	Vendor	CS/UOS	Location
80250061	18" H Green	026978021816	02181	10/10	East
80250065	18" White	026978021823	02182	10/10	East
80250121	18" Black	026978021885	02188	10/10	East
80250122	24" Black	026978022486	02248	10/10	East
80250062	24" H Green	026978022417	02241	10/10	East
80250066	24" White	026978022424	02242	10/10	East
80250123	30" Black	026978023087	02308	10/10	East
80250063	30" H Green	026978023018	02301	10/10	East
80250067	30" White	026978023025	02302	10/10	East
80250064	36" H Green	026978023612	02361	10/10	East
80250068	36" White	026978023629	02362	10/10	East
80250124	36" Black	026978023681	02368	10/10	East



Plastic Flower Box Tray

This plastic flower box tray is the perfect match for polypro and countryside flower boxes. Protects decks, patios and indoor areas.

Item #	Desc	UPC	Vendor	CS/UOS	Location
80250225	18" TC	026978101853	10185	10/10	East
80250224	18" White	026978101822	10182	10/10	East
80250421	18" Sage	026978101808	10180	10/10	East
80250854	18" Black	026978101884	10188	10/10	East
80250423	24" Sage	026978102409	10240	10/10	East
80250229	24" TC	026978102454	10245	10/10	East
80250228	24" White	026978102423	10242	10/10	East
80250855	24" Black	026978102485	10248	10/10	East
80250233	30" TC	026978103055	10305	10/10	East
80250232	30" White	026978103024	10302	10/10	East
80250856	30" Black	026978103086	10308	10/10	East
80250425	30" Sage	026978103000	10300	10/10	East



Flat Bottom Plastic Vase

Flat bottom plastic vase. Guaranteed leak proof. Stems lock in place so they come out of the ground with the vase.



Item #	Desc	UPC	Vendor	CS/UOS	Location
80250139	3" x 7"	026978050113	05011	36/36	East
80250146	4" x 6.6"	026978051219	05121	36/36	East
80250147	5" x 6.6"	026978051318	05131	36/36	East

Cone Cemetery Vase

These cone cemetery vases are guaranteed leak proof. The stem locks so the vase comes out of the ground with stem.



Item #	Desc	UPC	Vendor	CS/UOS	Location
80250142	4" Plastic	026978050717	5071	36/36	East
80250144	5" Plastic	026978050816	5081	36/36	East
80250141	5" Metal	026978050410	5041	36/36	East

Plastic Stone Vase

Stone colored plastic cemetery vase with fluted sides, rounded bottom and removable, locking 3" stem



Item #	Desc	UPC	Vendor	CS/UOS	Location
80250140	3"	026978050168	5016	36/36	East

Antique Kettle

Durable, weather-resistant black plastic kettles with hammered finish. Complete with black handle and three balancing legs. Ideal for outdoor patio and entry use. Optional punch-out holes allow for drainage.



Item #	Desc	UPC	Vendor	CS/UOS	Location
80250025	9" Black	026978480983	48098	6/6	East
80250026	12" Black	026978481283	48128	6/6	East
80250027	15" Black	026978481580	48158	6/6	East

Herb Trio Planter With Attached Tray

Suitable for use with any herbs, including basil, rosemary, parsley or chives. Indoor/outdoor use. Weather resistant.



Item #	Desc	UPC	Vendor	CS/UOS	Location
80250790	4" Grey	026978100108	10010	6/6	East
80250791	4" White	026978100122	10012	6/6	East

Earthbox Garden Kit

This set of 12 Earthboxes is sold as a unit. There is nodisplay rack but the set includes 4 each of colors Sage, Dark Green, and TerraCotta for a total of 12Earthbox kits (planting box,wheels, fertilizers, covers).



Item #	Desc	UPC	Vendor	CS/UOS	Location
80250586	Assorted colors	026978801074	80107.12	12/12	National

EarthBox® Staking System

The EarthBox® gardening system wouldn't be complete without a staking system. The staking system allows tall or vining crops to grow without falling over. Each staking system contains: 5 aluminum tubes, 2 "T" connectors, 2 straight connectors, 2 rim clamps with stainless steel hardware, 2 outrigger feet, 2 casters, 1 trellis net.



Item #	Desc	UPC	Vendor	CS/UOS	Location
80250600	Green	026978810113	81011	4/4	National
80250603	Terra Cotta	026978810151	81015	4/4	National

EarthBox® Root and Veg™ Garden Kit

This gardening system can grow larger and longer root crops such as carrots, rutabagas and parsnips, or just a single tomato plant. Includes: 4 pc. gardening system, 1 lb. Fertilizer and 1 lb. Organic Dolomite.



Item #	Desc	UPC	Vendor	CS/UOS	Location
80250626	Organic Gn	026978817518	81751	4/4	National
80250627	Organic TC	026978817556	81755	4/4	National
80250820	Sage	026978817006	81700	4/4	National



EarthBox® Garden Kit

This maintenance-free growing system controls soil conditions, eliminates guesswork, and more than doubles the yield of a conventional garden - with less fertilizer, less water, and virtually no effort. Just add plants, water, and sunlight for an easy garden that requires no digging, no weeding, and no guesswork! Grow tomatoes and other robust vegetables and aromatic herbs in any small space - a balcony, patio, or even rooftops!



Item #	Desc	UPC	Vendor	CS/UOS	Location
80250589	Green	026978801517	80151	4/4	National
80250581	Terra Cotta	026978801050	80105	4/4	National

EarthBox® Junior™ Organic Garden Kit

This compact-sized EarthBox® Junior™ is just like the original EarthBox® gardening system, with the same smart technology, but approximately half the size and specifically designed for smaller spaces. EarthBox® Junior™ is the perfect size for growing a kitchen herb garden and is ideal as a pretty window box with flowers.



Item #	Desc	UPC	Vendor	CS/UOS	Location
80250629	JR Green	026978806512	80651	6/6	National
80250630	JR Terra Cotta	026978806550	80655	6/6	National

EarthBox® Replant Kit

Allows you to re-use your EarthBox® gardening system (not included) year after year. Replaces essential nutrients.



Includes: 1lb 7-7-7 Fertilizer, 1lb Organic Dolomite and two black/white mulch covers



EarthBox® Organic Replant Kit

Includes: 1lb Organic Fertilizer, 1lb Organic Dolomite and two black/white mulch covers

Item #	Desc	UPC	Vendor	CS/UOS	Location
80250607	Replant Kit Standard	026978811004	81100	12/12	National
80250608	Replant Kit Organic	026978811011	81101	12/12	National

PANACEA®



Rope & Fern Hanging Basket (A)

Naturally beautiful and functional. Poly liner minimizes water leakage. Powder coated steel for added rust resistance.

Item #	Desc	UPC	Vendor	CS/UOS	Location
80160196	12" Cone	093432886366	88636	10/10	National

Growers Hanging Baskets (B)

Growers series hanging basket. Use multiple baskets and plants hung at different levels to create your own unique decorative effect. The durable, weather resistant finish of this planter will maintain its attractive dark green color and quality season after season. Includes coco fiber liner.

Item #	Desc	UPC	Vendor	CS/UOS	Location
80160006	12" Green	093432885000	88500	12/12	National
80160007	14" White	093432885048	88504	12/12	National

Black Rattan Hanging Basket (C)

Knots and curves on the twig construction add a rustic look to the basket, for a truly individual item. A metal framework helps hold the shape, and a plastic liner inside the basket keeps it water tight.

Item #	Desc	UPC	Vendor	CS/UOS	Location
80160199	12"	093432886403	88640	10/10	National
80160200	14"	093432886410	88641	10/10	National

Rustic Hanging Grower Basket (D)

This 12" hanging basket Includes burlap liner and easy-clip on wire painted hanger. Constructed of fashionable rust-finish chicken wire with burlap liners, these planters are designed for both high volume growers, as well as garden center retailers. Includes burlap liner and easy clip-on wire painted hanger.

Item #	Desc	UPC	Vendor	CS/UOS	Location
80160925	12"	093432842805	84280	25/25	National



Round Coco Fiber Liners

Formed liner fits inside hanging baskets. Great replacement liner that provided continued use of planters over and over.

Item #	Desc	UPC	Vendor	CS/UOS	Location
80160889	10"	093432841662	84166	24/24	National
80160009	12"	093432885918	88591	24/24	National
80160010	14"	093432885925	88592	24/24	National
80160011	16"	093432885932	88593	12/12	National
80160012	18"	093432885949	88594	12/12	National
80160987	20"	093432878231	87823	6/6	National

Trough Coco Liner

100% Coco fiber liner & adhesive glue components. Excellent water retention, keeps plants saturated & promotes healthy growth.

Item #	Desc	UPC	Vendor	CS/UOS	Location
80160917	24"	093432841693	84169	12/12	National
80160016	30"	093432885987	88598	12/12	National
80160017	36"	093432885994	88599	12/12	National
80160013	48"	093432885956	88595	12/12	National

2024

Half Round Coco Liner

Simply remove all the potting soil and plants from your planter, remove the old liner, replace it with the new liner, and add the soil and plants back to the basket. Extend the life of your wall baskets with this half round coco fiber liner.

Item #	Desc	UPC	Vendor	CS/UOS	Location
80160014	16"	093432885963	88596	12/12	National

Bulk Coco Liner

Bulk coco liner is pre-formed for easy installation. Long lasting coco fibers. Convenient cut to your own size. Keeps moisture in to help plants thrive.

Item #	Desc	UPC	Vendor	CS/UOS	Location
80160189	24"x33'	093432885888	88588	1/1	National
80160190	36"x33'	093432885895	88589	1/1	National



Milkhouse Vintage Planter

Has a vintage white enamel-ware look to it making it suitable for indoor and outdoor living. Animals include a rooster, pig, sheep, horse and cow (2 of each)

Item #	Desc	UPC	Vendor	CS/UOS	Location
80161566	7.5"	093432826157	82615	10/10	National



Half Bucket Galvanized Planter

Vertical wall half bucket rustic planter with wooden handle.

Item #	Desc	UPC	Vendor	CS/UOS	Location
80161085	Silver Aged	093432832202	83220	12/12	National
80161086	Assorted Blue, Yellow, Green, Purple	093432832219	83221	12/12	National

Square Herb Planters

These tin herb planters have retro graphics and a galvanized finish. A folding handle stays upright or folds back for shelf display. Holds four standard 3" plastic herb containers. 2 of each color per case



Item #	Desc	UPC	Vendor	CS/UOS	Location
80161224	10"	093432832554	83255	6/6	National

Lantern Planter w/ Hammered Copper Finish

Upgrade your space with this stylish short lantern planter. Small 13" lantern features a hammered copper finish



Item #	Desc	UPC	Vendor	CS/UOS	Location
80161928	13"	093432821961	82196	6/6	East



Retro Metal Chair Planters

These 19" metal chair planters take rustic & industrial chic garden décor to a fun and whimsical era. Assorted colors.

Item #	Desc	UPC	Vendor	CS/UOS	Location
80161211	19"	093432866252	86625	6/6	National

Farmers Market Oval Planter

This rustic Farmers Market Oval Planter features retro graphics and comes in a trendy aged galvanized finish. It holds three standard 3" plastic herb containers.



Item #	Desc	UPC	Vendor	CS/UOS	Location
80161225	16"	093432832653	83265	6/6	National

Galvanized Steel Oval Planters

These planters feature a trendy aged galvanized finish with convenient handles for carrying.



Item #	Desc	UPC	Vendor	CS/UOS	Location
80161227	10"	093432832516	83251	6/6	National
80161228	16"	093432832523	83252	6/6	National

Washtub Planter

Round washtub planter. Features steel construction with galvanized finish. Includes 2 sturdy handles for easy handling.



Item #	Desc	UPC	Vendor	CS/UOS	Location
80161226	8"	93432832509	83250	6/6	National

Woven Wire Herb Basket Planter

100% steel herb basket. Burlap liner included. Holds three standard three inch plastic herb containers.



Item #	Desc	UPC	Vendor	CS/UOS	Location
80161221	14"	093432832721	83272	6/6	National

Rustic Woven Wire Baskets

Rustic Farmhouse outdoor basket with rust finish speaks to the highly popular rustic trend; long-lasting burlap liner included. These planters are designed for both high volume growers, as well as garden center retailers.



Item #	Desc	UPC	Vendor	CS/UOS	Location
80160919	14"	093432842706	84270-6	6/6	National

Round Hanging Planter

Sturdy round metal plant hanger withstands the elements while providing secure support. Holds an 8" pot



Item #	Desc	UPC	Vendor	CS/UOS	Location
80161994	17" circle	093432810170	81017	6/6	National

Washtub Planter w/ Copper Handles

Modern Farmhouse designs are on-trend, classic looking garden accessories to decorate outdoor living spaces. Decorate your table with this smart, matte black bucket planter. The sturdy riveted copper plated handles add modern appeal and make it easy to move the piece.



Item #	Desc	UPC	Vendor	CS/UOS	Location
80161905	14"	093432814284	81428	6/6	National



Macramé Plant Hangers (A)

Simple, sleek version of macramé plant hanger. UV coated so that it can be used both indoors and out. This plant hanger has an authentic hand-made look about it that's sure to add a nostalgic touch to your home. All you have to do is choose your favorite potted plant to go inside. Assorted cases include 3 each of Jute/tan, Brown, Black, Rust, Sage, Forest Green, Navy and White.

Item #	Desc	UPC	Vendor	CS/UOS	Location
80780042	30" Jute	855354002084	2084	12/12	National
80780048	30" Asst.	855354002169	2169	24/24	National
80780051	36" Jute	855354002091	2091	12/12	National
80780057	36" Asst.	855354002176	2176	24/24	National
80780210	36" Neutral	855354002374	2374	20/20	National

All Natural Plant Hanger (B)

Can be used both indoor and outdoor. Holds a variety of sizes of planters weighing up to 20LB.

Item #	Desc	UPC	Vendor	CS/UOS	Location
80780145	36"	855254002855	2855	12/12	National

All Natural Knotted Rope Hanger (C)

Perfect to hold glassware, bowls, candle holders, etc.

Item #	Desc	UPC	Vendor	CS/UOS	Location
80780171	30"	894120001425	1425	12/12	National
80780172	36"	894120001432	1432	12/12	National

Mini Hangers (D)

Item #	Desc	UPC	Vendor	CS/UOS	Location
80780188	18" Twine	894120001654	1654	12/12	National
80780209	18" Macrame	855354002398	2398	12/12	National
80780219	18" Cotton	850007839185	9185	12/12	National



Beaded Cotton Hanger

Item #	Desc	UPC	Vendor	CS/UOS	Location
80780225	42"	850007839062	9062	6/6	National



Wooden Shelf Hanger

This gorgeous 12" pecan wooden table can be used as a night stand or coffee table. 36" hanger made of woven cotton.

Item #	Desc	UPC	Vendor	CS/UOS	Location
80780260	36"	850007839307	9307	5/5	National



Wall Planter

Decorative macramé wall hanger in Antique White, designed to perfectly hold a variety of sizes of pots.

Item #	Desc	UPC	Vendor	CS/UOS	Location
80780200	Large	855354002060	2060	6/6	National
80780201	Small	855354002077	2077	6/6	National



Wall Planter

Item #	Desc	UPC	Vendor	CS/UOS	Location
80780269	Small V Design	850007839420	9420	6/6	National
80780267	Small Diamond Design	850007839406	9406	6/6	National
80780268	Large V Design	850007839413	9413	6/6	National

PLANT HANGERS



Tassel Woven Plant Hanger (A)

Item #	Desc	UPC	Vendor	CS/UOS	Location
80780256	42" No Tassel	850007839529	9529	6/6	National

Brown Beaded Cotton Woven Hanger (B)

Item #	Desc	UPC	Vendor	CS/UOS	Location
80780254	42" Brown Beaded	850007839352	9352	6/6	National

Woven Plant Pouch (C)

Item #	Desc	UPC	Vendor	CS/UOS	Location
80780324	Small Plant Pouch	850007839741	9741	6/6	East
80780325	Large Plant Pouch	850007839888	9888	6/6	National

Woven Twisted Cord Hanger (D)

Item #	Desc	UPC	Vendor	CS/UOS	Location
80780223	42" Twisted Cord	850007839055	9055	6/6	National

Mini Woven ZigZag Hanger (E)

Item #	Desc	UPC	Vendor	CS/UOS	Location
80780250	17" Mini ZigZag	850007839345	9345	12/12	National

Macrame Plant Hanger (F)

Item #	Desc	UPC	Vendor	CS/UOS	Location
80780049	36" Black Macrame	855354002015	2015	12/12	East
80780050	36" White Macrame	855354002039	2039	12/12	East

Woven Plain Cord Hanger (G)

Item #	Desc	UPC	Vendor	CS/UOS	Location
80780224	42" Plain Cord	850007839079	9079	6/6	East

2-Tier Woven Hanger (H)

Item #	Desc	UPC	Vendor	CS/UOS	Location
80780222	60" 2-Tier	850007839123	9123	6/6	East

2-Tier Hanging Utility Basket (I)

Item #	Desc	UPC	Vendor	CS/UOS	Location
80780328	Double Tier	850007839819	9819	6/6	East

Hanger Plant Hooks

White ceiling hanger hooks. Each retail ready pack contains three pieces.



Item #	Desc	UPC	Vendor	CS/UOS	Location
80780244	3 Pack	894120001852	1852	12/12	East

Hanger Plant S-Hooks

S-hooks - 3 pieces per retail ready package



Item #	Desc	UPC	Vendor	CS/UOS	Location
80780245	3 Pack	894120001869	1869	12/12	East



Mini Green Jute Hanger

Item #	Desc	UPC	Vendor	CS/UOS	Location
80780213	18"	894120001845	1845	12/12	National

Hang Planter

A stylish woven cotton planter in beige or natural cotton. Customers can add their favorite plant to this popular planter.



Item #	Desc	UPC	Vendor	CS/UOS	Location
80780356	Beige	850052957070	7070	6/6	East
80780357	White	850052957087	7087	6/6	East

2024

Macrame Plant Hammock Assorted



Item #	Desc	UPC	Vendor	CS/UOS	Location
80780258	48"	850007839260	9260	10/10	National

Beaded Plant Hanger

This gorgeous new Beaded Plant Hanger Nest holds up to a 6in pot. Includes decorative beads and a wooden O-Ring at the top.



Item #	Desc	UPC	Vendor	CS/UOS	Location
80780347	40" Nest	850007839918	9918	6/6	East

Macrame USA Flag

A bohemian yet patriotic wall display of the American flag in woven macrame details. Complements well with coordinating designs for an artisanal home decor collection.



Item #	Desc	UPC	Vendor	CS/UOS	Location
80780345	17" x 22"	850007839703	9703	6/6	National



A



B



Item #	Desc	UPC	Vendor	CS/UOS	Location
80780182	A Terra Cotta Mini Pot W/ Hanger	894120001456	1456	12/12	National
80780181	B Terrarium W/ Hanger	894120001449	1449	12/12	National



Best Buds Boxed Pot W/ Hanger

Item #	Desc	UPC	Vendor	CS/UOS	Location
80780283	Lucy	850007839598	9598	12/12	National
80780282	Bud	850007839581	9581	12/12	National



Mini Hanger

Woven Cotton Plant Hanger / Car Accessories / Rear View Mirror Charm / Cute Hanging Rearview Car Decor Boho Hanger. Pop in your favorite mini succulent. (plant is not included in this)



Item #	Desc	UPC	Vendor	CS/UOS	Location
80780354	Mini Car Hanger	850052957056	7056	12/12	East

Basket Planters

3pc - With Wooden Legs



Item #	Desc	UPC	Vendor	CS/UOS	Location
80780358	3 PC	850052957100	7100	2/2	East



Assorted Plant Hangers

Item #	Desc	UPC	Vendor	CS/UOS	Location
80780211	A 30" Neutral Macramé	855354002381	2381	20/20	National
80780246	18" Jute Colored	894120001883	1883	12/12	East
80780177	B 36" Jute Colored	894120001524	1524	24/24	National
80780221	C 18" Mini Cotton	850007839208	9208	28/28	National
80780033	D 30" Neutral Fabric	855354002206	2206	24/24	National



Flex Garden & Storage Set

Built-in drip Tray Sturdy Construction good for herbs vegetables and flower great for small spaces adjust to any area each planter is 20" x 13" x 12". Kit includes 3 planters and 2 legs.



Item #	Desc	UPC	Vendor	CS/UOS	Location
81250843	Grey	684143081319	HDR-081319	8/8	East



Bushel Basket

Item #	Desc	Vendor	CS/UOS	Location
81250851	8" Brown w/ Tan Wash	CF-078814	12/12	East
81250852	8" Tan w/ Brown Wash	CF-078821	12/12	East
81250756	8" Tan	CF-078821	1000/1000	East
81250755	8" Tan w/ Brown Wash	CF-078814	1000/1000	East
81250853	13" Brown w/ Tan Wash	CF-078838	12/12	East
81250758	13" Tan	CF-078845	500/500	East
81250854	13" Tan w/ Brown Wash	CF-079378	12/12	East
81250757	13" Tan w/ Brown Wash	CF-078838	500/500	East



Westlake Rustic Galvanized Planters

Item #	Desc	UPC	Vendor	CS/UOS	Location
81250363	12" Hanging Basket	684143054801	HDR-054801	12/12	East
81250364	24" Deck Rail	684143054818	HDR-054818	3/3	East
81250277	16" Square	684143046851	HDR-046851	4/4	East
81250362	15" Round	684143054795	HDR-054795	8/8	East
81250683	10" Round	684143064787	HDR-064787	12/12	East
81250278	20.5" Round	684143046868	HDR-046868	4/4	East
81250841	79pc Mix	684143064053	HDR-064053G	1/1	East



Item #	Desc	UPC	Vendor	CS/UOS	Location
EMMA ROUND (A)					
81250893	6" Gray	684143086147	CRM-086147	4/4	East
81250894	8" Gray	684143086154	CRM-086154	2/2	East
ANNANDALE (B)					
81250889	6" Celadon	684143086109	CRM-086109	4/4	East
81250890	8" Celadon	684143086116	CRM-086116	2/2	East
VADO (C)					
81250891	6" Sea Blue	684143086123	CRM-086123	4/4	East
81250892	8" Sea Blue	684143086130	CRM-086130	2/2	East
AVA (D)					
81250875	6" Brown	684143085966	CRM-085966	4/4	East
81250876	8" Brown	684143085973	CRM-085973	2/2	East
81250877	12" Brown	684143085980	CRM-085980	1/1	East
OAKLAND (E)					
81250873	6" Blue	684143085942	CRM-085942	4/4	East
81250874	8" Blue	684143085959	CRM-085959	2/2	East
JASPER (F)					
81250878	6" Teal	684143085997	CRM-085997	4/4	East
81250879	8" Teal	684143086000	CRM-086000	2/2	East
81250880	12" Teal	684143086017	CRM-086017	1/1	East
FRENCH RUSTIC (G)					
81250881	6" White	684143086024	CRM-086024	4/4	East
81250882	8" White	684143086031	CRM-086031	2/2	East



Succulent Bowl Tray

Item #	Desc	UPC	Vendor	CS/UOS	Location
81250377	H 3.5" (24)	684143054870	CRM-054870G	1/1	East
81250696	I 3.5" (12)	684143064893	CRM-064893G	1/1	East

12" Tampa Hanging Basket

Item #	Desc	Vendor	CS/UOS	Location
81250917	Eggnog	HDR-086574	12/12	East
81250918	Gray Flannel	HDR-086581	12/12	East
81250919	Caribou	HDR-086598	12/12	East



Item #	Desc	UPC	Vendor	CS/UOS	Location
GLOSSY					
81250868	16" Chocolate Cloud		HDR-087120	8/8	East
81250869	18" Chocolate Cloud		HDR-087199	6/6	East
ANTHONY					
81250866	12"		HDR-087793	12/12	East
COLLINS					
81250886	6" Blue	684143086079	CRM-086079	4/4	East
81250883	6" Oxblood	684143086048	CRM-086048	4/4	East
81250887	8" Blue	684143086086	CRM-086086	2/2	East
81250884	8" Oxblood	684143086055	CRM-086055	2/2	East
81250888	12" Blue	684143086093	CRM-086093	1/1	East
81250885	12" Oxblood	684143086062	CRM-086062	1/1	East
RIVER ROCK					
81250867	15"Grey	684143086680	HDR-086680	4/4	East
ALICE					
81250687	6"	684143064794	CRM-064794	4/4	East
81250688	8"	684143064800	CRM-064800	2/2	East
BRENTWOOD					
81250689	6"	684143064879	CRM-064879	4/4	East
81250690	8"	684143064886	CRM-064886	2/2	East

Ana Planter

Handmade clay pottery offers an authentic and unique planter for your garden. Gloss finish and styling provide an elegant appearance. Protective rubber pads to prevent scratching.



Item #	Desc	UPC	Vendor	CS/UOS	Location
81250693	6"	684143064817	CRM-064817	4/4	East
81250694	8"	684143064824	CRM-064824	2/2	East
81250695	12"	684143064831	CRM-064831	1/1	East

Standard Clay Pot



Item #	Desc	UPC	Vendor	CS/UOS	Location
81250703	10"	684143043259	TC1006SPT	6/6	East

Reactive Red & Navy Mixed Pallet

Assorted pallet 32 pieces (9each) 12" Navy / 12" Red (7each) 18" Navy / 18" Red



Item #	Desc	UPC	Vendor	CS/UOS	Location
81250920	18"	40684143094576	HDR-094579G	1/1	East

Quilted Bell Planter, Black Whitewash



Item #	Desc	UPC	Vendor	CS/UOS	Location
81250280	13"	684143046813	CF-046813	6/6	East



*Made of HDR Plastic



Jocelyn Pallet (A)

Item #	Desc	UPC	Vendor	CS/UOS	Location
81250870	48pc	684143086413	CRM-086413G	1/1	East

Panarea & Vivara Pallet (B)

Item #	Desc	UPC	Vendor	CS/UOS	Location
81250924	24pc	40684143091835	CRM-091837G	1/1	East

Beehive Pallet (C)

18" Plastic Planters with Attached saucers. 8 of each color, Red splatter, Navy, White, and Gray

Item #	Desc	UPC	Vendor	CS/UOS	Location
81250682	32pc assortment (4 colors)	684143064107	HDR-064107G	1/1	East

Jori Pallet (D)

Item #	Desc	UPC	Vendor	CS/UOS	Location
81250698	32pc	684143064299	CRM-064299G	1/1	East

Cathedral Pallet (E)

Item #	Desc	UPC	Vendor	CS/UOS	Location
81250700	27pc	684143064398	CRM-064398G	1/1	East

Natalie & Baku Pallet (F)

Item #	Desc	UPC	Vendor	CS/UOS	Location
81250846	27pc	684143078388	CRM-078388G	1/1	East



Heritage 12" & 16" Mixed Pallet

620 pieces | 12" - 320 | 16" - 300

Item #	Desc	UPC	Vendor	CS/UOS	Location
81250922	Mixed	40684143094613	HDR-094616G	1/1	East



Barndoor 15" Square Mixed Pallet

108 pieces
(54) Brown Barn Door
(54) Gray Barn Door

Item #	Desc	UPC	Vendor	CS/UOS	Location
81250921	15"	40684143094607	HDR-094609G	1/1	East

12" Kay Planter



Item #	Desc	UPC	Vendor	CS/UOS	Location
81250567	3 gal Blue	684143068440	CF-068440	12/12	East
81250559	2.5 gal Hanging Basket Blue	684143068365	CF-068365	12/12	East
81250638	3 gal Pink	684143069331	CF-069331	12/12	East
81250569	3 gal White	684143068464	CF-068464	12/12	East
81250570	3 gal Red	684143068471	CF-068471	12/12	East

URN PLANTERS



Utopian

The utopia urn is a long time classic. It's height and fluted lines on the side give it a regal appearance and it is perfect for fuller plants and shrubs. The poly-resin construction of the dynamic design planter series provides a sturdy product that is light weight and UV protected.

Item #	Desc	UPC	Vendor	CS/UOS	Location
81250133	14" Black	038776003079	UU1412BK	12/12	East
81250135	19" Black	038776002072	UU1906BK	6/6	East
81250136	19" Stone	038776002133	UU1906ST	6/6	East

Grecian

Resin based urn is lighter weight and more durable than traditional materials. UV coated finish provides a weather resistant, long-resistant, long lasting color.

Item #	Desc	UPC	Vendor	CS/UOS	Location
81250130	18" Black	049206030602	UR1810BK	10/10	East

15" Tampa

Item #	Desc	Vendor	CS/UOS	Location
81250863	Eggnog	HDR-086642	6/6	East
81250864	Grey Flannel	HDR-086659	6/6	East
81250865	Caribou	HDR-086666	6/6	East

HDR® Wine Barrel

With a down-home, country-style feel, our HDR® wine barrel creates the perfect combination of elegance and simplicity to your outdoor or indoor living space. UV protectors increase resistance to cracking and fading. Your vibrant colored flower or vegetable arrangements will provide a pleasing pop of color in these dark, faux-wood planters.



Item #	Desc	UPC	Vendor	CS/UOS	Location
81250005	15" KY Walnut	684143007227	HDR-007227	10/10	East

Whiskey Barrel Planters

Features a 3-band whiskey barrel design. This resin planter has UV protectors to resist fading and cracking. Material has more endurance than wood.



Item #	Desc	UPC	Vendor	CS/UOS	Location
81250367	15" Birch	684143055457	HDR-055457	12/12	East
81250370	22" Birch	684143055488	HDR-055488	8/8	East
81250368	22" Walnut	684143055464	HDR-055464	8/8	East
81250432	Mix Pallet 57 pieces	40684143055509	HDR-055501G	1/1	East



Pinot Barrels Planters

Three new Pinot Barrels have replaced the Whiskey Barrels for 2024. The style and color offerings of the barrels have been updated for a more current and contemporary look that aligns with consumer preferences. The Pinot Barrels are available in wood-look finishes of Natural Oak, Weathered Teak, and Kentucky Walnut.

Item #	Desc	UPC	Vendor	CS/UOS	Location
81250958	15.5" Oak	684143101994	10000-03313	12/12	East
81250960	15.5" Walnut	684143102014	10000-03315	12/12	East
81250959	15.5" Teak	684143102007	10000-03314	12/12	East
81250961	22.25" Oak	684143102021	10000-03316	8/8	East
81250963	22.25" Walnut	684143102045	10000-03318	8/8	East
81250962	22.25" Teak	684143102038	10000-03317	8/8	East

Whiskey Basket Planter



Item #	Desc	Vendor	CS/UOS	Location
81250818	22" Basswood full pallet	CF-070184	36/36	East
81250752	22" Basswood	CF-070245	6/6	East

Copper & Silver Barnett Pallet

These attractive ploy resin planters are great for any deck or indoor planting 15" Planters 54 Piece Mix Pallet



Item #	Desc	Vendor	CS/UOS	Location
81250923	54 pieces (27 Copper / 27 Silver)	HDR-094562G	1/1	East

Lacis Trellis Planter

Utilized cutting edge techniques to produce a resin planter of superior quality with precise coloration, texture and finish. Crafted from durable high-density resins



Item #	Desc	UPC	Vendor	CS/UOS	Location
81250375	15" Round Trellis	684143054863	HDR-054863	12/12	East
81250373	15" Round	684143054849	HDR-054849	6/6	East
81250374	16" Square	684143054856	HDR-054856	6/6	East

Plantable Birdhouse

The SuperMoss Amber Plantable Birdhouse is a cute way to plant everything from succulents to mosses to grasses. It has a small container on top with a plastic liner to keep the soil and water out of the birdhouse. It looks amazing planted and very cute with silk plants. They are great for floral projects, crafting, or gardening planters! Includes a mixed set of 3 Amber Plantable Birdhouses.



Item #	Desc	UPC	Vendor	CS/UOS	Location
80231353	3 Color Set	759834568001	56800	2/2	National



Cone Hanging Basket

Item #	Desc	UPC	Vendor	CS/UOS	Location
80230811	12" Diamond Hill	759834296683	29668	8/8	National
80230807	12" Mammoth	759834296607	29660	8/8	National
80230696	12" Wintergreen	759834296669	29666	8/8	East



Wood Woven 14" Pyramid Basket



Item #	Desc	UPC	Vendor	CS/UOS	Location
80230805	June	759834296317	29631	8/8	National
80230804	Stratton	759834296300	29630	8/8	National

Vineyard Basket Set

Small - 4¾" x 4¼"
Medium - 5½" x 4¾"
Large - 6¾" x 5"



Item #	Desc	UPC	Vendor	CS/UOS	Location
80230104	3 pc.	759834551508	55150	6/6	National

Woodbury Round Hanging Basket



Item #	Desc	UPC	Vendor	CS/UOS	Location
80230815	14"	759834297048	29704	8/8	National

Ventura Deco Basket Set

Small - 4.7" x 4.7" x 3.9"
Medium - 5.1" x 5.1" x 4.3"
Large - 5.9" x 5.9" x 4.3"
XLarge - 7¼" x 7¼" x 4¾"



Item #	Desc	UPC	Vendor	CS/UOS	Location
80230100	4 pc.	759834550709	55070	6/6	East



Deco Basket Vista Round

5.5" Diam x 4.2" / 7.5" Diam x 5" / 9.5" Diam x 5.5". Unique moss

covered basket with a protective liner. Recommended for indoor use as well as for covered outdoor environments such as patios and porches.



Item #	Desc	UPC	Vendor	CS/UOS	Location
80230107	Set of 3	759834555902	55590	6/6	National



Deco Basket Arroyo

Decorative Baskets are a cute way to organize both indoor & outdoor floral arrangements or centerpieces. They are made from the same high-quality green Mountain Moss as the rest of our creative line. We design decorative table baskets in an ample variety.

Item #	Desc	UPC	Vendor	CS/UOS	Location
80230059	Set of 3	759834555209	55520	6/6	National



Miramonte Basket Set

Deco round handle basket that's longer lasting, has a vibrant color, is cleaner to use and is more pliable. Comes in pack of 3. Set of 3 - Small (5" Diam x 2.5" Deep x 8.25" H with Handle), Medium (6.75" Diam x 3" Deep x 9.5" H with Handle), Large (8.25" Diam x 3.75" Deep x 11" H with Handle).

Item #	Desc	UPC	Vendor	CS/UOS	Location
80230080	3 pc.	759834555100	55510	6/6	National

Beaumont Deco Purse Set

Wicker handles, Small - 8" x 3½" x 5½" Medium - 10" x 3½" x 5¾" Large - 12" x 4" x 6"



Item #	Desc	UPC	Vendor	CS/UOS	Location
80230067	3 pc.	759834555049	55504	6/6	National

Beaumont Deco Baskets

Small: 7.9" x 3.7" x 5.1" Medium: 5.91" x 5.914" x 4.33" Set of Three: Small - 7" x 3¾" x 9¾" Medium - 8½" x 3" x 5" Large - 10½" x 3¾" x 9¾"



Item #	Desc	UPC	Vendor	CS/UOS	Location
80230066	Small	759834555018	55501	12/12	National
80230064	Medium	759834555025	55502	12/12	National
80230020	3 pc.	759834555001	55500	6/6	National



Beaumont Lavender Purse

Lavender - Set of 3 / Small (7.9" L x 3.7" W x 5.1" H), Medium (8.5" L x 3" W x 5" H), Large (10.5" L x 3.75" W x 9.75" H). Unique fresh green colored moss covered basket with a protective liner. Recommended for indoor use as well as for covered outdoor environments such as patios and porches.

Item #	Desc	UPC	Vendor	CS/UOS	Location
80230627	Set of 3	759834557005	55700	6/6	National

Deco Purse Wicker Side

Small (7.9in L x 3.7in W x 5.1in H) Medium (8.5in L x 3in W x 5in H) Large (10.5in L x 3.75in W x 9.75in H)



Item #	Desc	UPC	Vendor	CS/UOS	Location
80230021	Set of 3	759834555056	55505	6/6	National



Ball Planter

12" x 12" x 12" x 20" Black metal chain included

Item #	Desc	UPC	Vendor	CS/UOS	Location
80230364	12"	759834293422	29342	4/4	National

Plantable Birdhouse Gazebo

Woven Birdhouses are made the same way as our MossWeave Baskets, and are extremely durable and meant for outdoor and garden use. The nests maintain their shape through the elements and will not deteriorate for multiple years. Each house comes with an elegant chain to easily hang from a tree branch or hook.



Item #	Desc	UPC	Vendor	CS/UOS	Location
80230936	Plantable House	759834567011	56701	6/6	National

2024

Coffee Cup Deco Baskets

Deco Collection: 4" & 6" decorative coffee cups.



Item #	Desc	UPC	Vendor	CS/UOS	Location
80230123	4"	759834552543	55254	12/12	National
80230124	6"	759834552567	55256	12/12	National

Shasta Deco Basket

9.9" x 6.3" x 4.3"



Item #	Desc	UPC	Vendor	CS/UOS	Location
80230094	Shasta Basket	759834550235	55023	12/12	National

Watering Can

Rustic Deco collection



Item #	Desc	UPC	Vendor	CS/UOS	Location
80230429	5" Small	759834552598	55259	12/12	National
80230141	7" Medium	759834552604	55260	12/12	National
80230430	9" Large	759834552611	55261	12/12	National



Peace Sign Planter

Express yourself with our Modern Planters. A clean matte white finish complements a variety of 2" drop in plants.

Item #	Desc	UPC	Vendor	CS/UOS	Location
81510404	Peace	038858606433	7450-04-222	4/4	National

Paula Pumps

Deco Moss shoe basket
10" x 5 1/2"



Item #	Desc	UPC	Vendor	CS/UOS	Location
80230022	Classic	759834555732	55573	12/12	National

Hang Loose Planter

Express yourself with our Modern Planters. A clean matte white finish complements a variety of 2" drop in plants.



Item #	Desc	UPC	Vendor	CS/UOS	Location
81510405	Hang Loose	038858606457	7451-04-222	4/4	National

4 Pc. Terrarium Tool Kit

Includes rake, shovel, brush and tweezers. Wooden handles and metal tips. Use when making a terrarium.



Item #	Desc	UPC	Vendor	CS/UOS	Location
81510045	4pc	38858069368	9680-12-00	12/12	National

Pebble Planter



Item #	Desc	UPC	Vendor	CS/UOS	Location
81510359	4.5"	038858120069	750-06-437	6/6	East

Never Dry Plant Pal Singles

Soaking device helps water your plants. Clay base releases water when soil needs it. Waters your plants by diffusion. Best used with a long neck bottle.



Item #	Desc	UPC	Vendor	CS/UOS	Location
81510056	Plant Pal	038858077929	6715-24-00	24/24	National

Prism Bowl



Item #	Desc	UPC	Vendor	CS/UOS	Location
81510320	6.375"	038858074591	3512-06-09	6/6	National

Terrarium Cloche

Fun, modernized take on terrariums. Built-in holes on cloche limit fogginess. Remove cloche to water accordingly.



Item #	Desc	UPC	Vendor	CS/UOS	Location
81510017	7" x 8.25"	038858067708	3776-04-09	4/4	National

Olivia Bowl



Item #	Desc	UPC	Vendor	CS/UOS	Location
81510322	9 ³ / ₄ " x 4 ³ / ₄ "	38858050090	6/9/3360	6/6	National

Stoneware Tapered Pot



Item #	Desc	UPC	Vendor	CS/UOS	Location
81510455	2" Charcoal	038858619730	7943-24-1235	24/24	National
81510493	2" White	038858619631	7943-24-22	24/6	National
81510456	4" Charcoal	038858619754	7944-06-1235	24/24	National
81510450	4" White	038858619631	7944-06-22	24/24	National
81510451	4.5" White	038858619655	7945-06-22	6/6	National
81510457	4.5" Charcoal	038858619778	7945-06-1235	6/6	National

Stoneware Trio Assortment

Show off three of your favorite succulents or small plants in this modern tapered trio assortment planter. Each planter has a glazed interior and a drainage hole and all three planters fit nicely in a drainage tray.



Item #	Desc	UPC	Vendor	CS/UOS	Location
81510454	Trio Tray	038858619716	7948-02-22	6/6	National

Canyon Glass Miniature Collection

Height range: 3⁵/₈"-3³/₄". Width range: 3"-4". Openings: 2⁵/₈"-2³/₄" Fits 2"-2¹/₂" drop ins.



Item #	Desc	UPC	Vendor	CS/UOS	Location
81510391	Asst.	038858606136	3623-12-1251	12/12	National



Essential Vase

Item #	Desc	UPC	Vendor	CS/UOS	Location
81510410	4" White	038858098177	9331-06-1184	6/6	East



Desert Sunrise Tins

3" x 2½" Tin Miniatures. Opening: 2⅝". Fits 2"-2½" drop ins.

Item #	Desc	UPC	Vendor	CS/UOS	Location
81510392	Asst.	038858606150	3730-12-1266	12/12	National

Mini Hanging Animals

3" Mini hanging animals. Hang on the side of your favorite planter! Assorted PDQ displays easily on shelves or counter tops. Ceramic turtle, frog and hedgehog.



Item #	Desc	UPC	Vendor	CS/UOS	Location
81510430	Hanging Asst Animals	038858606662	7898-12-1315	12/12	National



Mini Terracotta Animal Planters

Assorted PDQ displays easily on shelves or counter tops. Terracotta llama, turtle, elephant and hedgehog. Height range: 2½"-3" (elephant & llama heads up to 6"). Opening: 2"-2½".

Item #	Desc	UPC	Vendor	CS/UOS	Location
81510428	Terracotta Asst Planters	038858606624	7896-12-1295	12/12	National



Mini Ceramic Animal Planters

Assorted PDQ displays easily on shelves or counter tops. Ceramic llama, turtle, elephant and hedgehog. Height range: 2½"-3½". Opening: 2"-2½".

Item #	Desc	UPC	Vendor	CS/UOS	Location
81510429	Ceramic Asst Planters	038858606648	7897-12-1305	12/12	National

Founded in 2007 Tusco Products is a leading manufacturer of rotational molded planters and accessories both traditional and modern styling. We offer our customers light weight, extremely durable planters with a 10-year warranty and all our products are manufactured in the USA.

Modern Colonial Garden Planter

Long-lasting beauty, durability, and quality. Built-in water reservoir encourages healthy plant growth by allowing plants to practically water themselves. Beautiful Modern Colonial design adds a charming touch to any patio or deck.



Item #	Desc	UPC	Vendor	CS/UOS	Location
80520403	16" Black	810738031111	MC16BK	1/1	National
80520402	16" White	810738031173	MC16WH	1/1	National
80520406	20" Black	810738032118	MC20BK	1/1	National
80520405	20" White	810738032170	MC20WH	1/1	National



Shiplap Planter

Long-lasting beauty, durability, and quality. Built-in water reservoir encourages healthy plant growth by allowing plants to practically water themselves. Beautiful Shiplap design adds a charming touch to any patio or deck.

Item #	Desc	UPC	Vendor	CS/UOS	Location
80520418	14" Black	810738029415	SL14BK	1/1	National
80520419	14" Safari	810738029439	SL14SF	1/1	National
80520420	14" White	810738029422	SL14WH	1/1	National
80520421	24" Black	810738029446	SL24BK	1/1	National
80520422	24" Safari	810738029460	SL24SF	1/1	National
80520423	24" White	810738029453	SL24WH	1/1	National

Modern Tall Square Planter

This fresh design of the modern planter provides a great touch to your outdoor space with a textured all-over finish.



Item #	Desc	UPC	Vendor	CS/UOS	Location
80520264	19" Black	810738025219	MSQT19BK	2/2	National
80520265	19" Espresso	810738025226	MSQT19ES	2/2	National
80520266	19" Slate	810738025202	MSQT19SL	2/2	National
80520260	23" Black	810738025110	MSQT23BK	2/2	National
80520261	23" Espresso	810738025127	MSQT23ES	2/2	National
80520262	23" Slate	810738025103	MSQT23SL	2/2	National

Modern Square Planter

This fresh design of the modern planter provides a great touch to your outdoor space with a textured all-over finish.



Item #	Desc	UPC	Vendor	CS/UOS	Location
80520272	16" Black	810738025417	MSQ16BK	4/4	National
80520273	16" Espresso	810738025424	MSQ16ES	4/4	National
80520274	16" Slate	810738025400	MSQ16SL	4/4	National
80520269	20" Espresso	810738025325	MSQ20ES	4/4	National
80520270	20" Slate	810738025301	MSQ20SL	4/4	National
80520268	20" Black	810738025318	MSQ20BK	4/4	National

Black Cosmo Planters

Quality planter with the classic look of clay and natural stone but without the expense, cracking, and heavy weight. Planter is rotation molded to achieve a natural look that is durable and weatherproof. Undrilled.



Item #	Desc	UPC	Vendor	CS/UOS	Location
80520093	26" Square Black	810738022911	CTU26BK	2/2	National
80520089	32" Square Black	810738022812	CUT32BK	2/2	National
80520064	26" Round Black	810738022218	CTR26BK	2/2	National

Urn Planter

Urn Planter - Rotation molded, lightweight planter. Weatherproof; resistant to heat and cold. Undrilled. Rock fill line in each pot. 10-year manufacturer's warranty. Contains 100% recycled materials.



Item #	Desc	UPC	Vendor	CS/UOS	Location
80520120	17" Black	810738023314	UR01BK	2/2	National

Garland Urn Planter

These urns are weatherproof. They are resistant to heat and cold. Each pot has drain plugs that are undrilled and a rock fill line.



Item #	Desc	UPC	Vendor	CS/UOS	Location
80520053	14"	810738021662	GU14WTC	6/6	National



Rolled Rim Pot

Made of lightweight, rotation molded plastic. Weatherproof so you can use it indoors or outdoors all summer and winter without worrying about fading or cracking.



Item #	Desc	UPC	Vendor	CS/UOS	Location
80520002	13 ¹ / ₂ " Sandstone	810738020146	RR135SS	6/6	National
80520001	13 ¹ / ₂ " Terra Cotta	810738020153	RR135TC	6/6	National
80520006	15 ¹ / ₂ " Terra Cotta	810738020252	RR155TC	6/6	National
80520017	24 ¹ / ₂ " Sandstone	810738020443	RR245SS	4/4	National
80520016	24 ¹ / ₂ " Terra Cotta	810738020450	RR245TC	4/4	National
80520021	30" Terra Cotta	810738020559	RR30TC	1/1	National
80520023	30" Espresso	810738020528	RR30ES	1/1	National
80520024	30" Black	810738020511	RR30BK	1/1	National
80520027	36" Sandstone	810738020641	RR36SS	1/1	National
80520026	36" Terra Cotta	810738020658	RR36TC	1/1	National
80520032	42" Sandstone	810738020740	RR42SS	1/1	National
80520031	42" Terra Cotta	810738020757	RR42TC	1/1	National

Swan Planter

16" Plastic Blow-Mold Swan Planter with a yellow bill. Has a 6 1/2" x 8 1/2" opening.



Item #	Desc	UPC	Vendor	CS/UOS	Location
81320008	8"	078304518200	51820	12/12	East
81320009	11"	078304518309	51830	12/12	East
81320007	16"	078304516800	51680	6/6	East

Lamb Planter

18" Plastic Blow-Mold Lamb Planter with pink accents. Has a 5" diameter opening.



Item #	Desc	UPC	Vendor	CS/UOS	Location
81320011	18"	078304516909	51690	6/6	East

Pig Planter

18 1/2" Plastic Blow-Mold Pig Planter. Has a 6" diameter opening.



Item #	Desc	UPC	Vendor	CS/UOS	Location
81320091	18 1/2"	078304533609	53360	6/6	East

Cow Planter

18 1/2" Plastic Blow-Mold Cow Planter with black spots. Has a 5" diameter opening.



Item #	Desc	UPC	Vendor	CS/UOS	Location
81320014	18 1/2"	078304533500	53350	6/6	East

3-Piece Swan Planter Set

Large swan stands about 16" tall, medium swan is 11" tall and small swan is 8" tall. Each has a large opening in the back for planting.



Item #	Desc	UPC	Vendor	CS/UOS	Location
81320010	3 pieces	078304518606	51860	5/5	East

Round Grecian Urn Planter

Plastic blow-mold Grecian urn planter. Measures 16 1/2" tall x 15 1/4" in diameter. Urn has 12 1/2" opening on top for planting.



Item #	Desc	UPC	Vendor	CS/UOS	Location
81320039	Concrete	78304533005	53300	6/6	East
81320040	Black	78304533043	53304	6/6	East

Aztec Strawberry Jar

Plastic resin strawberry jar. Great for strawberries, flowers, hen-and-chicks, or herbs.



Item #	Desc	UPC	Vendor	CS/UOS	Location
81320035	8"	078304528803	52880	12/12	East
81320036	14"	078304529008	52900	8/8	East

Black Cauldrons

This blow molded cauldron has a wider rim style that's a versatile favorite. No hole in bottom.



Item #	Desc	UPC	Vendor	CS/UOS	Location
81320058	12" & 8"	078304553300	55330	4/4	East
81320059	16" & 12"	078304553508	55350	2/2	East
81320063	8" w/handle	078304552808	55280	12/12	East
81320034	8"	078304550804	55080	12/12	East

Dutch Kettle Planter

Styled like a cast iron classic, this black dutch kettle planter is crafted of heavy-duty plastic with 3 raised feet and handle.



Item #	Desc	UPC	Vendor	CS/UOS	Location
81320046	14"	078304552402	55240	6/6	East



All planters feature drain holes.

10" Hanging Watering Can Planter

4 assorted finishes, easy to assemble.



Item #	Desc	UPC	Vendor	CS/UOS	Location
80730445	Watercolor	727744800672	KDHWWCWC	12/12	East
80731067	Vintage	727744801181	KDHWCVI	12/12	East

KD Watering Can Planter - Embossed Collection

10" Embossed Metallic Collection in Silver, Red, Purple, Teal with drainage holes.



Item #	Desc	UPC	Vendor	CS/UOS	Location
80730444	10"	727744800665	KDWC10EM	12/12	National

KD Watering Can Planter - Galvanized Brushed

4 assorted finishes, easy to assemble.



Item #	Desc	UPC	Vendor	CS/UOS	Location
80731156	7"	727744803062	KDWC7GB	12/12	East



Hand Painted Floral KD Watering Can Planter

4 assorted styles with drainage, easy to assemble.

Item #	Desc	UPC	Vendor	CS/UOS	Location
80731263	10"	727744803642	KDWC10HF	12/12	East

KD Watering Can Planter - Vintage Collection

10" Vintage Collection in assorted finishes with drainage, easy to assemble.



Item #	Desc	UPC	Vendor	CS/UOS	Location
80730657	10"	727744801198	KDWC10VI	12/12	National

Vintage Oval Watering Can Planter

13" Oval KD Watering Can Planters in assorted finishes with drainage holes.



Item #	Desc	UPC	Vendor	CS/UOS	Location
80730553	13"	727744800979	KDWC13V	8/8	East



KD Watering Can Planter - Watercolor Collection

Fuchsia, Goldenrod, Tangerine, Teal. Easy to assemble.

Item #	Desc	UPC	Vendor	CS/UOS	Location
80730128	7"	727744800436	KDWC7WC	12/12	National
80730120	10"	727744800368	KDWC10WC	12/12	National



KD Watering Can Planter - Americana Collection

4 assorted colors, easy to assemble.

Item #	Desc	UPC	Vendor	CS/UOS	Location
80730113	10"	727744800351	KDWC10A	12/12	National

Wall Hanging Watering Can Planters

Key West Watering Can Wall Planters feature one flat side with screw holes for mounting easily to a wall.



Item #	Desc	UPC	Vendor	CS/UOS	Location
80731028	10" wide	727744802461	KDWAL10KW	12/12	East



All planters feature drain holes.



Polka Dot Watering Can Planter

2 assorted styles, no assembly required

Item #	Desc	UPC	Vendor	CS/UOS	Location
80730998	6.5"	727744802744	FPDWC6	12/12	East



2024

KD Watering Can Planters Polka Dot

10" KD Polka Dot Watering Can Planters

Item #	Desc	UPC	Vendor	CS/UOS	Location
80731336	10"	727744904028	KDWC10PD	12/12	East



10" Water Can Planters

Item #	Desc	UPC	Vendor	CS/UOS	Location
80731154	A-Elegant	727744802997	KDWC10EL	12/12	National
80731155	B-Shimmer	727744803079	KDWC10SH	12/12	National



Bug Watering Can Planter

4 colors assorted, no assembly required!

Item #	Desc	UPC	Vendor	CS/UOS	Location
80731303	4.5"	727744904059	FBWC4	24/24	East



Key West Collection

Turquoise, Coral, Lilac, Lime. Easy to assemble.

Item #	Desc	UPC	Vendor	CS/UOS	Location
80730125	7"	727744800504	KDWC7KW	12/12	East
80730117	10"	727744800474	KDWC10KW	12/12	East
80730446	10" HB	727744800689	KDHWC KW	12/12	East



Vintage Flower Shower Planter

Assorted Finishes - Embossed Design. Easy to assemble.

Item #	Desc	UPC	Vendor	CS/UOS	Location
80730888	10"-Round	727744801716	FSP10VI	12/12	East
80730887	17"-Oval	727744801723	FSO17VI	12/12	East



Bright Flower Shower Planter

17" Flower Shower Oval Planter Water Color Collection Teal, Tangerine, Goldenrod, Fuchsia colors with drainage holes. 3 of each color per case pack.

10" Flower Shower Oval Planter Water Color Collection Teal, Tangerine, Goldenrod, Fuchsia colors with drainage holes. 3 of each color per case pack.

Item #	Desc	UPC	Vendor	CS/UOS	Location
80730368	17" Key West- Oval	727744800603	FSO17KW	12/12	East
80730369	17" Watercolor- Oval	727744800597	FSO17WC	12/12	East
80730370	10" Key West- Rnd	727744800627	FSP10KW	12/12	East
80730371	10" Watercolor-Rnd	727744800610	FSP10WC	12/12	East



All planters feature drain holes.

Galvanized Umbrella Planters

13" Galvanized Umbrella Hanging Planter with drainage holes.

18" Galvanized Umbrella Planter with drainage holes.



Item #	Desc	UPC	Vendor	CS/UOS	Location
80730879	13"-HB	727744801884	FHUMB13	8/8	East
80730623	18"-Plntr	727744801686	FUMB18	6/6	East

Wheelbarrow Planter

15"L x 7"W x 7"T. Assorted Colors.



Item #	Desc	UPC	Vendor	CS/UOS	Location
80731129	7"	727744803291	FWBP7	6/6	East

Oval Planter w/ Stripe

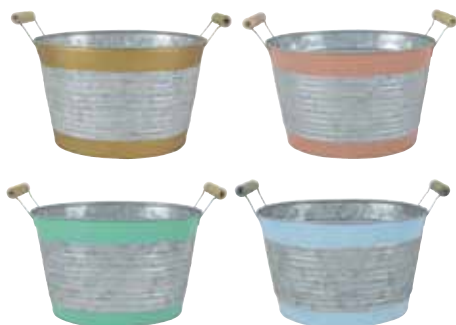

Item #	Desc	UPC	Vendor	CS/UOS	Location
80730881	9"	727744801891	FPASO9	12/12	East



Sun & Compass Planters

11" Metal Sun and Compass Planters in two colors with rope handles and drainage holes

Item #	Desc	UPC	Vendor	CS/UOS	Location
80731225	11"	727744803727	FSCP11	12/12	East



Oval Planters W/ Rope Handle

12" Metal Oval Daisy Planters with rope handles and drainage holes. Assorted colors, 3 of each color per case pack

Item #	Desc	UPC	Vendor	CS/UOS	Location
80731210	12"	727744803765	FOPRH12	12/12	East



Purse Planter

10" Purse Planter with Rope Handle

Item #	Desc	UPC	Vendor	CS/UOS	Location
80731220	10"	727744803758	FPPRH10	12/12	East

Beautiful Blooms Planters

10" "Beautiful Blooms" planters in 4 assorted finishes with drainage holes.



Item #	Desc	UPC	Vendor	CS/UOS	Location
80730609	10"	727744801167	FBBA10	12/12	East

Flower Garden Metallic Planters

10" "Flowers & Garden" embossed planters in 4 assorted finishes with drainage



Item #	Desc	UPC	Vendor	CS/UOS	Location
80730435	10"	727744800641	FGMP	12/12	East



All planters feature drain holes.

Dotted Planter

Stylish metal planters are perfect accents for dropping in plants. 4 colors, white, teal, orange, and yellow. All planters feature drainage holes.



Item #	Desc	UPC	Vendor	CS/UOS	Location
80731304	7"	727744904066	FDOT7	24/24	East



Colorful Pail Planters W/ Handles

8" Metal Colorful Pail Planters in assorted colors with drainage holes. 6 of each color in a case pack

Item #	Desc	UPC	Vendor	CS/UOS	Location
80731200	8"	727744803741	FPPH8	24/24	East

Geometric Embossed Planter

Metal planters in 4 finishes, galvanized, fuchsia, teal, and rose gold with a white rub. All planters come with drainage holes.



Item #	Desc	UPC	Vendor	CS/UOS	Location
80731308	11"	727744904110	FGEOP11	12/12	East

Embossed Planter with White Rub

Metal planters in 4 colors: coral, blue, yellow, gray. All planters come with drainage holes.



Item #	Desc	UPC	Vendor	CS/UOS	Location
80731117	10" Assort.	727744803130	FEPR10	12/12	East

Vintage Embossed Planters

These planters bring a rustic, farmhouse charm. Assorted finishes with rope handles. All planters feature drain holes.



Item #	Desc	UPC	Vendor	CS/UOS	Location
80731004	9"	727744802690	FVE9	12/12	East

Elegant Flowers & Garden Metal Planters

11" Elegant Flowers and Garden Metal Planter with metal handles and drainage holes. 3 of each color per case pack.



Item #	Desc	UPC	Vendor	CS/UOS	Location
80730508	11"	727744800856	FGPOT11	12/12	East



Vintage Paint Pail Planter

This planter can hang from the handle or sit on the porch.

Item #	Desc	UPC	Vendor	CS/UOS	Location
80730894	10"-Assort	727744801709	FVPP10	12/12	East



Zinc Colorful Mini Planter

6" Zinc Mini Colorful Flowers and Garden Planter with rope handles and drainage holes. 3 assorted colors.

Item #	Desc	UPC	Vendor	CS/UOS	Location
80731008	6"	727744802799	FZMP6	24/24	East



Metal Flowers & Garden Planters

10" Metal Flowers and Garden Planter with rope handles and drainage holes. Assorted colors

Item #	Desc	UPC	Vendor	CS/UOS	Location
80730946	10"	727744801730	MP109C	12/12	East



All planters feature drain holes.



Bug Pail Planters

8" Metal Pail Bug Planters in assorted colors with drainage holes

Item #	Desc	UPC	Vendor	CS/UOS	Location
80730982	8"	727744802737	FBUG8	24/24	East

Butterfly And Dragonfly Pail Planters

9" Metal Butterfly and Dragonfly planters in assorted colors with drainage holes



Item #	Desc	UPC	Vendor	CS/UOS	Location
80730980	9"	727744401510	FBDP9	12/12	East



Bloom/Plants Planters

9" Metal blooms/plants planters with drainage. Assorted colors, plants/blooms is two sided

Item #	Desc	UPC	Vendor	CS/UOS	Location
80731198	9"	727744803710	FBLPL9	12/12	East



Flowers Planters

11" Flowers planter with rope handles, has drainage holes. Galvanized, matte finish with an embossed pattern. 4 assorted colors

Item #	Desc	UPC	Vendor	CS/UOS	Location
80730996	11"	727744802706	FP11	12/12	East

Planter with Gold Bee

Stylish metal planters with honeycomb and a bee. All planters come with drainage holes. 2 assorted finishes



Item #	Desc	UPC	Vendor	CS/UOS	Location
80731312	12"	727744904127	FPGB12	8/8	East

Round Vintage Planters

These planters bring a rustic, farmhouse charm. All planters feature drain holes. 2 assorted finishes



Item #	Desc	UPC	Vendor	CS/UOS	Location
80731001	15"	727744802720	FRVP15	12/12	East

Barrel & Leaf Planters

Plastic resin planters upgrade any plant.



Item #	Desc	UPC	Vendor	CS/UOS	Location
80731212	10"	727744803468	FPLBL10	24/24	East



Stars and Stripes Planters

Item #	Desc	UPC	Vendor	CS/UOS	Location
80730554	7" Watering Can	727744801105	KDWC7SS	12/12	National
80730551	10" Watering Can	727744801051	KDWC10SS	12/12	East
80730548	10" Hanging Watering Can	727744800993	KDHCSS	12/12	National
80731006	12" Wide Wall Planter	727744802447	FWPSS	12/12	National
80730552	13" Oval Watering Can	727744800986	KDWC13SS	8/8	National
80730890	17" Oval	727744801747	FSSP17	12/12	National



All planters feature drain holes.

Farmhouse Planter w/ Handle

Metal planters in 4 colors copper, black, white and galvanized. All planters come with drainage holes.



Item #	Desc	UPC	Vendor	CS/UOS	Location
80731307	7"	727744904080	FFPW7	24/24	East



Colorful Purse Planter

Colorful 12" purse planters in goldenrod, turquoise, fuchsia, lilac with drainage holes

Item #	Desc	UPC	Vendor	CS/UOS	Location
80730616	12"	727744801594	FPURKW	8/8	East



Pail Planter W/ Striped Paint

10" Metal Pail Planter in assorted colors with drainage. You can even display this planter by hanging it!

Item #	Desc	UPC	Vendor	CS/UOS	Location
80731222	10"	727744803666	FPSP10	12/12	East



Garden Rectangle Planter

Assorted Colors - 10" Wide x 6" Long x 4" High. All planters come with drainage holes.

Item #	Desc	UPC	Vendor	CS/UOS	Location
80731118	10" Assort.	727744803246	FGRP10	12/12	East



Galvanized White Embossed Planters

10" Galvanized Planters in assorted patterns and styles with drainage holes

Item #	Desc	UPC	Vendor	CS/UOS	Location
80731208	10"	727744803734	FGWEP10	12/12	East



Pail Planter w/ Rub

Pail Planters in 4 assorted finishes.

Item #	Desc	UPC	Vendor	CS/UOS	Location
80731219	10"	727744803680	FPPR10	12/12	East



Handpainted Floral Oval Planter

Handpainted floral oval metal planters in 4 colors: yellow, black, rose, and white. All planters come with drainage holes.

Item #	Desc	UPC	Vendor	CS/UOS	Location
80731310	17"	727744904042	FHPO17	12/12	East

Metal Purse Planter

Charming galvanized purse planter with embossed dragonfly design. Able to hang as well!



Item #	Desc	UPC	Vendor	CS/UOS	Location
80731311	10"	727744904097	FMPP10	6/6	East

Metal Embossed Purse Planter

Metal planters with a rustic galvanized metal finish. 2 styles



Item #	Desc	UPC	Vendor	CS/UOS	Location
80730507	14"	727744800863	FEPP14	6/6	East



All planters feature drain holes.



12" Hanging Planter

Item #	Desc	UPC	Vendor	CS/UOS	Location
80730517	A Copper	727744801150	FZHP12C	12/12	East
80730763	B Zinc	727744800702	FZHP12	12/12	East



Hanging Colander Planter with Coco Liner

11" comes in 4 assorted colors, 8" comes in 2 assorted colors. Hanger and coco liner included.

Item #	Desc	UPC	Vendor	CS/UOS	Location
80730973	11" HB	727744802386	FCLHC11	12/12	East
80730985	8" HB	727744802775	FCLHC8	12/12	East



Ombre & Stripe Blue Red Planters

8" Plastic planters in assorted colors with drainage holes. Beautiful glossy finishes

Item #	Desc	UPC	Vendor	CS/UOS	Location
80731215	8"	727744803444	FPLOS8	24/24	East

Ceramic Shine Bright Planters

2 styles, assorted



Item #	Desc	UPC	Vendor	CS/UOS	Location
80731202	4"	727744803802	FCSBP4	24/24	East

Ceramic Marbled Teacup Planter

2 assorted colors



Item #	Desc	UPC	Vendor	CS/UOS	Location
80730987	8"	727744802829	FCMT8	8/8	East



Cocoa Mug Planters

3 assorted styles

Item #	Desc	UPC	Vendor	CS/UOS	Location
80730872	7"	727744801792	FCOCO7	12/12	East



Ceramic Insect Mug Planter

3 assorted styles

Item #	Desc	UPC	Vendor	CS/UOS	Location
80730505	5"	727744801082	FCDMI5	12/12	East

Polka Dot Teacup Planters

Polka Dot Teacup Planters Assorted Colors Bring the whimsical tea time experience to your garden or patio with these planters. Great teacher or Mother's Day gift items. All planters feature drain holes.



Item #	Desc	UPC	Vendor	CS/UOS	Location
80730997	5"	727744802751	FPDTC5	12/12	East



Wish Planters

Metal planters in 4 accent colors pink, yellow, grey, and blue. All planters come with drainage holes.

Item #	Desc	UPC	Vendor	CS/UOS	Location
80731130	8" Assort	727744803222	FWISH8	24/24	East



All planters feature drain holes.

Cement Planter w/ White Rub

2 styles, assorted



Item #	Desc	UPC	Vendor	CS/UOS	Location
80731201	3"	727744803635	FCPWR3	12/12	East

Ceramic Vines Planters

2 styles, assorted



Item #	Desc	UPC	Vendor	CS/UOS	Location
80731203	5"	727744803819	FCVP5	12/12	East

Wood Crate Assortment

Planters in 4 colors. 2 of each color in each style. 2 styles – Rectangular and Fluted



Item #	Desc	UPC	Vendor	CS/UOS	Location
80731053	22.5"	727744802881	PAWCA2	16/16	East

Reclaimed Wood Planters

This is a set of 6 planters, pack 2 sets of 6 per case.

Item #	Desc	UPC	Vendor	CS/UOS	Location
80730884	Assort.	727744801822	FRWS6	2/2	East

Antiqued Stone Face Planter

Durable resin planter. All planters feature drain holes.



Item #	Desc	UPC	Vendor	CS/UOS	Location
80730978	4"	727744802812	FACE4	12/12	East

Turtle & Snail Planter

6" Opening, 13" Tall x 9" Wide x 9" Long. Whimsical resin planters in 2 assorted designs



Item #	Desc	UPC	Vendor	CS/UOS	Location
80731316	6" Planters	727744904141	FTS6	4/4	East

Branch & Trunk Planters

Trunk: 2.5" Opening, 4.5" Diam. x 7" Tall

Branch: 5.5" x 2" Opening, 8.25" Wide x 4" Long x 4" Tall



Item #	Desc	UPC	Vendor	CS/UOS	Location
80731302	Branch & Trunk Planters	727744904158	FBTP2	12/12	East



Hedgehog, Owl, & Frog Planters

Hedgehog: 5.75" Planter, 7.5" Wide x 11.5" Long x 6.5" Tall

Owl: 4.25" Planter, 9" Wide x 8" Long x 8.5" Tall

Frog: 5" Planter, 8.5" Wide x 12" Long x 6.5" Tall

Item #	Desc	UPC	Vendor	CS/UOS	Location
80731309	Animal Planter	727744904165	FHOF5	6/6	East

Planter w/ Chalkboard Stand

Whimsical chalkboard sign planter. Chalk is included!



Item #	Desc	UPC	Vendor	CS/UOS	Location
80730984	10"	727744802645	FCHALK10	3/3	East

Coco Liner Bulk Roll



Item #	Desc	UPC	Vendor	CS/UOS	Location
81730196	33' X 36"	745487009909	R990	1/1	East

Potato Tub

Reusable potato planting container. Collapsible potato planting garden with drainage holes. Tough, heavy-duty polypropylene with strong stitched carry handles. 20"x16"



Item #	Desc	UPC	Vendor	CS/UOS	Location
81730061	Pack of 2	745487075058	7505	18/18	East

Tall Round Dragonfly Planters

SM 6.62"HX8.25"
MED 7.5"HX9.75"
LG 8.5"HX11"



Item #	Desc	UPC	Vendor	CS/UOS	Location
81730642	Tall		H16S1579	4/4	East

Square Planter w/ Dragonflies

Square planter embossed with a beautiful dragonfly motif. Made of durable galvanized steel. Set of 3: small – 7.48" x 6.89" x 6.89" medium – 8.66" x 8.26" x 8.26" large – 9.45" x 9.84" x 9.84" Case contains 4 sets of 3.



Item #	Desc	UPC	Vendor	CS/UOS	Location
81730646	3 pc.	814567028304	H16A1171	4/4	East



Standard Italians With Saucer

pricing per set - 12 or 6 per set depending on size - sold as 1/1

Item #	Desc	UPC	Vendor	CS/UOS	Location
81730982	4" Cobalt Blue 12pc	811421030602	W22 66300	1/1	East
81730983	4" Tropical Green 12pc	811421030626	W22 66500	1/1	East
81730984	4" Graphite 12pc	811421030633	W22 66600	1/1	East
81730985	6" Cobalt Blue 6pc	811421030657	W22 66800	1/1	East
81730986	6" Tropical Green 6pc	811421030671	W22 67000	1/1	East
81730987	6" Graphite 6pc	811421030688	W22 67100	1/1	East



Murphy Collection

(Sold as set of 108 pieces) 9 of each style in assorted sizes

Item #	Desc	UPC	Vendor	CS/UOS	Location
81730979	108 PC	811421036383	W22 64900	1/1	East

Round Dragonfly Planters w/ Handles

SM 6.5"HX6.5"
MED 7.5"HX7.5"
LG 8.35"HX8.35"



Item #	Desc	UPC	Vendor	CS/UOS	Location
81730636	Handles		H16A1177	4/4	East

Traditional Hanging Basket w/ Coco Basket

Gardman traditional black metal banded hanging basket complete with coco liner.



Item #	Desc	UPC	Vendor	CS/UOS	Location
81730147	12"	745487004072	R407	15/15	East
81730148	14"	745487004089	R408	15/15	East
81730149	16"	745487004096	R409	15/15	East

Wire Grow Basket

16" coco basket with 4 leg heavy gauge hanger. Each basket has a pre-formed coco liner with a plastic dish to cover the base and creates a reservoir of water.



Item #	Desc	UPC	Vendor	CS/UOS	Location
81730027	16" - Black	745487004225	R422	25/25	East

Rustic Rattan Hanging Basket

Galvanized steel frames add strength and ensure long life. Plastic liner allows planter to be used indoors or out. When used outdoors it is recommended that drainage holes be made in the plastic liner.



Item #	Desc	UPC	Vendor	CS/UOS	Location
81730204	14" Hive HB	745487002986	R298	10/10	East
81730215	16" Rattan Wall Basket	745487004966	R496	10/10	East
81730205	14" Rattan Half Hive Wall Basket	745487002993	R299	10/10	East

Forge Hanging Basket

Basket comes with pre-formed coco liner and heavy grade chain.



Item #	Desc	UPC	Vendor	CS/UOS	Location
81730142	14"	745487009466	R946	5/5	East

Blacksmith Wall Trough With Coco Liner

Beautiful wrought iron design blacksmith trough planter. Features an attractive barley twist design on center of all vertical rods. Heavy-duty solid rod and square steel construction with welded joints.



Item #	Desc	UPC	Vendor	CS/UOS	Location
81730156	30" Blacksmith	745487009671	R967	3/3	East
81730184	30" Replacement liners	745487008797	R879	5/5	East
81730183	36" Liner in Display Carton	745487008780	R878	10/10	East

Forge Wall Trough With Coco Liner

Old English styling and flat back for wall mounting. Thicker, rust-resistant metal used throughout. This wall trough planter has a wider, deeper trough for additional soil to provide for stronger growth and reduce the frequency of watering.



Item #	Desc	UPC	Vendor	CS/UOS	Location
81730138	24" Trough & Coco	745487009428	R942	5/5	East
81730136	30" Trough & Coco	745487009398	R939	5/5	East
81730182	24" Replacement liners	745487008773	R877	10/10	East

Coco Basket Liners

Long lasting coco fibers, pre-formed for easy installation. The popular choice among consumers and growers.



Item #	Desc	UPC	Vendor	CS/UOS	Location
81730175	12"	745487005833	R583	25/25	East
81730176	14"	745487005840	R584	25/25	East
81730177	16"	745487005857	R585	25/25	East
81730187	18"	745487008858	R885	5/5	East

Coco Wall Basket Liners

The natural coconut fiber is coated in latex to prolong the lifespan of the liner. This also helps this liner retain moisture and aerate the soil, saving you water and improving the plant's quality of life.



Item #	Desc	UPC	Vendor	CS/UOS	Location
81730189	20"	745487008919	R891	5/5	East

BIRDING SUPPLIES



CHECK OUT OUR
CLEARANCE ITEMS!



Griffin Greenhouse Retail WAREHOUSE Shipping Map

We are now shipping nationwide!

NATIONAL



2024

Refer to location key:

National items are stocked nationally
 Select items are sold East or West only; no exceptions

8" Kaleidoscope Planter

Premium plastic modular planter can be displayed individually each planter has a removable saucer ideal for succulents or shallow rooted planted.

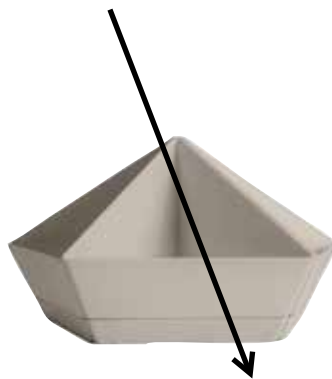

Item #	Desc	UPC	Vendor	CS/UOS	Location
80282643	Vanilla Bisque	770932844170	KDP08000A58	6/6	National

Where is the pricing?

1. Scan QR code on Chapter Pages to see pricing on Griffins.com
2. Contact your Griffin Sales Representative
3. Call into Griffin Customer Service 800.888.0054





Fiber Clay Bird Baths

Lightweight for easy transportation. Breaks down into three pieces for easy storage. Can be filled with sand for more stability. Measures 20" diam. x 20½" H.



Item #	Desc	UPC	Vendor	CS/UOS	Location
80690290	Stone	849637000294	BB05	4/4	East
80690289	Green	813001016464	BB04	4/4	East

Plastic Bird Bath

Resin plastic bird bath includes support stakes included for extra stability. Lightweight for easy transportation. Breaks down into four pieces for easy storage.

Measures 19.5"x30".



Item #	Desc	UPC	Vendor	CS/UOS	Location
80690650	Bronze	849637003646	BB06	4/4	East



Weather Guard

Give your songbirds shelter and keep the rain out on your Brome Squirrel Buster Plus bird feeder with this weather guard accessory! UV protected polycarbonate. Feeder not included.



Item #	Desc	UPC	Vendor	CS/UOS	Location
80430008	13"	628209010264	1026	4/4	East

Squirrel Buster

Openings in the shroud align with the feeding ports, providing birds access to the food. When a squirrel climbs onto the feeder, its weight automatically forces the shroud down, closing access to the ports. Squirrels and some large birds are foiled but not harmed in any way.



Item #	Desc	UPC	Vendor	CS/UOS	Location
80430003	1.5 Quart	628209010165	1016	2/2	East

Squirrel Buster® Series

Truly Squirrel-proof™



Classic™ (A)

Clinging and perching birds have easy access to the food ports that are aligned with the wire shroud. Dismantles for easy cleaning

Item #	Desc	UPC	Vendor	CS/UOS	Location
80430002	1.5 qt.	628209010158	1015	2/2	East

Plus™ (B)

Guaranteed effective against grey squirrels. The six bottom seed ports close from the weight of the squirrel that forces the shroud over the seed ports. Top selling cardinal friendly feeder! 6.5W x 6.5L x 23.75H.

Item #	Desc	UPC	Vendor	CS/UOS	Location
80430001	3 qt.	628209010240	1024	2/2	East

Mini™ (C)

Compact design is easy to fill, chew proof, and features 4 seed ports.

Item #	Desc	UPC	Vendor	CS/UOS	Location
80430005	¾ qt.	628209010554	1055	4/4	East

Standard™ (D)

The patented squirrel proof design has chew-proof components. The weight adjustable closing mechanism, patented Seed Tube Ventilation system, and proven Seed Saver Technology, with stainless steel perches are award winning features. 5"W x 5"L x 13.25"H.

Item #	Desc	UPC	Vendor	CS/UOS	Location
80430006	¾ qt.	628209010578	1057	4/4	East

Legacy™ (E)

Openings in the shroud align with seed ports, providing birds access to the food. When a squirrel climbs onto the feeder, its weight automatically forces the shroud down, closing access to the seed.

Item #	Desc	UPC	Vendor	CS/UOS	Location
80430010	1½ qt.	628209010820	1082	2/2	East



Tin Cone Birdhouse

Add a unique piece to your back yard habitat. Set of 2 Tin Cone Birdhouses per case.



Item #	Desc	UPC	Vendor	CS/UOS	Location
81791421	Tin Cone Birdhouse Set	612524537155	13072	1/1	East



Tea Pot Birdhouse

9.4X4.3X11.2X27.6"

Item #	Desc	UPC	Vendor	CS/UOS	Location
81791769	Tea Pot Birdhouse	766282810644	13076	4/4	National



Flaming Squirrel Seed Sauce™

A nutritional birdseed supplement that contains all natural, 100% food grade ingredients with a super hot and spicy flavor. Birds love the taste of this liquid chili pepper formula exploding with tons of Cajun spice. When mixed with your favorite birdseed, it's guaranteed to increase bird visits at your feeder.



Item #	Desc	UPC	Vendor	CS/UOS	Location
80370065	8 oz.	751478102429	FS08	12/12	East

Special Feeder Suet Cake

Chock full of pecans and peanuts, it's a shoe-in to be your woodpecker's favorite suet. It is best served during the cooler months of fall and winter.



Item #	Desc	UPC	Vendor	CS/UOS	Location
80370056	11 oz.	751478100326	SFSU	12/12	East

Cracked Corn

Cracked Corn is an inexpensive feed that appeals to a wide range of ground feeding birds such as cardinals, white-throated sparrows, towhees, ducks, and doves.



Item #	Desc	UPC	Vendor	CS/UOS	Location
80370036	5 lb.	751478100838	CC05	6/6	East

Natural Peanut Suet Cake

This special no melt formula wins taste tests hands down. With the peanut butter base that birds prefer, it's two steps above your average peanut suet.



Item #	Desc	UPC	Vendor	CS/UOS	Location
80370058	12 oz.	751478101927	NPSU	12/12	East

Blue Ribbon Suet Cake

A "Better" all-purpose soft suet that attracts the largest variety of songbirds. Full of much needed calories and fiber, Blue Ribbon Blend™ suet cakes are a great substitute for insects during the fall and winter months.



Item #	Desc	UPC	Vendor	CS/UOS	Location
80370055	11 oz.	751478100128	BRSU	12/12	East

Hot Meats Suet Cake

Now available for the very first time – chili pepper suet mixed with Sunflower Meats! Our famous best seller presented in a no melt suet cake that's guaranteed to attract more wild birds to your suet feeder.



Item #	Desc	UPC	Vendor	CS/UOS	Location
80370057	12 oz.	751478101422	HMSU	12/12	East



Niger Seed

Often mistakenly called Thistle seed, is a favorite of beautiful wild finches like the American Goldfinch. It is best used in a specifically designed tubular feeder with small holes where it can be economically dispensed.

Item #	Desc	UPC	Vendor	CS/UOS	Location
80370024	5 lb.	751478100739	NI05	6/6	East
80370025	10 lb.	751478100746	NI10	4/4	East
80370026	20 lb.	751478100753	NI20	2/2	East

Oil Sunflower

Over 99% pure and cleaned four times to ensure that you get more seed and fewer sticks. Plus it's positively chock full of oil. You want as much oil in your sunflower as you can get because that's what attracts the birds. High-grade, high-oil sunflower means more birds at your bird feeder.

Item #	Desc	UPC	Vendor	CS/UOS	Location
80370021	8 lb.	751478100616	OS08	4/4	East
80370022	16 lb.	751478100661	OS16	2/2	East

Raw Peanuts

Higher in essential fat and protein than peanut hearts and pieces, Raw Peanuts are a great attraction for titmice, nuthatches, wrens, and woodpeckers.

Item #	Desc	UPC	Vendor	CS/UOS	Location
80370030	5 lb.	751478100937	RP05	6/6	East
80370031	10 lb.	751478100944	RP10	4/4	East

Safflower Seed

Safflower is a lifesaver for those of you having trouble with squirrels. Most squirrels and blackbirds don't like it, while cardinals, nuthatches, and chickadees can't resist it. So if you're tired of feeding more squirrels than birds, Safflower is definitely for you.

Item #	Desc	UPC	Vendor	CS/UOS	Location
80370009	5 lb.	751478100432	SA05	6/6	East
80370010	10 lb.	751478100449	SA10	4/4	East
80370011	20 lb.	751478100456	SA20	2/2	East

Sunflower Meats

This is pure sunflower and the birds' number one choice. With almost no shell, you get more feed per pound and no messy hulls to clean up. It's perfect if you want to feed from balconies and decks without the mess of leftover shells.

Item #	Desc	UPC	Vendor	CS/UOS	Location
80370013	5 lb.	751478100531	SM05	6/6	East
80370014	10 lb.	751478100548	SM10	4/4	East
80370015	20 lb.	751478100555	SM20	2/2	East

Hot Meats™

Nutritious sunflower meats infused with fiery hot habanero chilies, Hot Meats™ are a great no waste, no mess feed. Bluebirds and cardinals are especially fond of the hot Cajun flavor. With Cole's Hot Meats™ you'll get more bird visits than ever before.

Item #	Desc	UPC	Vendor	CS/UOS	Location
80370017	5 lb.	751478101439	HM05	6/6	East
80370018	10 lb.	751478101446	HM10	4/4	East
80370019	20 lb.	751478101453	HM20	2/2	East

Special Feeder™

This unique mix is a high energy treat for many birds. Cole's most popular blend because it attracts the greatest number of wild birds than any other mix out there. Plus woodpeckers absolutely love the pecans.

Item #	Desc	UPC	Vendor	CS/UOS	Location
80370005	5 lb.	751478100333	SF05	6/6	East
80370006	10 lb.	751478100340	SF10	4/4	East
80370007	20 lb.	751478100357	SF20	2/2	East

Finch Friends™

Developed for use in a regular tubular feeder, no thistle feeder needed. Just fill up your everyday feeder with Finch Friends™ and soon beautiful goldfinches, purple finches, and pine siskins will be dining at your door. Contains sunflower meats, & niger seeds.



Item #	Desc	UPC	Vendor	CS/UOS	Location
80370027	5 lb.	751478101231	FF05	6/6	East
80370028	10 lb.	751478101248	FF10	4/4	East
80370029	20 lb.	751478101255	FF20	2/2	East

Blue Ribbon Blend™

A traditional mix done right, Cole's guarantees you'll get the best combination of perching and ground feeding birds with this one. So, just fill up your feeder and stand back.



Item #	Desc	UPC	Vendor	CS/UOS	Location
80370001	5 lb.	751478100135	BR05	6/6	East
80370002	10 lb.	751478100142	BR10	4/4	East
80370003	20 lb.	751478100159	BR20	2/2	East

2024

Nutberry Suet Blend™

Combines all of nature's best in one delicious blend. Attract fruit and insect loving songbirds to your feeder with this unique mix of premium fruits, preferred nuts, nutritious insect suet kibbles, and whole kernel sunflower meats. Bluebirds, warblers, robins, woodpeckers and more absolutely love this special treat. This is the ultimate trail mix for your wild birds.



Item #	Desc	UPC	Vendor	CS/UOS	Location
80370043	5 lb.	751478100234	NB05	6/6	East
80370044	10 lb.	751478100241	NB10	4/4	East
80370045	20 lb.	751478100258	NB20	2/2	East

Critter Munchies™

Critter Munchies™ works well in a platform feeder or scattered on the ground. Either way squirrels, chipmunks, and rabbits can't get enough. Contains Whole Yellow Corn, Striped Sunflower, Peanuts in the Shell, Black Oil Sunflower, and Raw Peanuts.



Item #	Desc	UPC	Vendor	CS/UOS	Location
80370039	5 lb.	751478101132	CM05	6/6	East

Blazing Hot Blend™

100% all natural, chemical free way to increase the number of birds visiting your feeder. It combines a patented habanero chili oil formula with the most preferred seeds of backyard songbirds. Woodpeckers, grosbeaks, buntings, cardinals, chickadees, bluebirds, goldfinches, and more find this mix irresistible.



Item #	Desc	UPC	Vendor	CS/UOS	Location
80370051	5 lb.	751478102535	BH05	6/6	East
80370052	10 lb.	751478102542	BH10	4/4	East
80370053	20 lb.	751478102559	BH20	2/2	East

Cajun Cardinal Blend™

Even wild birds like a little Cajun spice now and then, so we've combined the fiery hot chilies of Hot Meats™ with Safflower (a favorite of cardinals) to create a sure-fire winner for all your chickadees, titmice, woodpeckers, bluebirds, and of course – cardinals.



Item #	Desc	UPC	Vendor	CS/UOS	Location
80370047	5 lb.	751478101538	CB05	6/6	East
80370048	10 lb.	751478101545	CB10	4/4	East

Dried Mealworms

Easier to feed and less messy than live mealworms, these energy packed morsels are Mother Nature's perfect treat for all your insect loving songbirds. Approximately 2,800 Dried Mealworms.



Item #	Desc	UPC	Vendor	CS/UOS	Location
80370063	3 1/2 oz.	751478102313	DRMW	6/6	East

Hummingbird Feeder

4 feeding ports. Full perch ring. Easy to clean and refill. Wire hanger included.



Item #	Desc	UPC	Vendor	CS/UOS	Location
80400195	18 oz	085199221412	HUM141	6/6	National

Mini Feeder

Heath Hummingbird Feeder Mini (Holds 3 oz) in Counter Display. Bringing nature closer. Easy to clean. Display can fit on peg hooks or be placed on shelf.



Item #	Desc	UPC	Vendor	CS/UOS	Location
80400107	3 oz.	85199223126	HUMF23	28/28	National

Bat House Display Pack

The Heath Outdoor Product Single Bat House can be mounted on a pole, or under the eaves of a house, garage or barn approximately 12-15 feet above the ground. This house is maintenance free and provides a welcoming habitat to encourage brown bats to nest in appropriate boxes. Brown bats can consume 600 mosquitos in an hour, helping to naturally control insects.



Item #	Desc	UPC	Vendor	CS/UOS	Location
80400100	Bat House	085199101028	BAT-1	4/4	National

Ant Moat Hummingbird Feeder Flower

The Heath Flower Ant Moat hangs conveniently above your hummingbird or oriole feeder to prevent crawling insects from contaminating the nectar. Simply fill the cup with water and insects will be unable to climb down. Using an ant moat will cut down on wasted nectar and help prevent the spread of illness in birds.



Item #	Desc	UPC	Vendor	CS/UOS	Location
80400321	Yellow Ant Moat	085199114011	AM-1	12/12	East

Citrus Grove Suet Cake

Citrus Grove suet cakes are blended with sunflower seeds, safflower, grains and orange flavoring to attract a variety of colorful songbirds. Suet cakes are a great treat during migration and winter-months and our cakes are perfect for year-round feeding with our no-melt formula. Guaranteed fresh.



Item #	Desc	UPC	Vendor	CS/UOS	Location
80400134	9.25 oz	085199050234	DD-23	16/16	National

Multi-Grain Suet Cake

Multi-grain suet to attract colorful songbirds. Mixed sunflower seeds, grains and peanut flavoring.



Item #	Desc	UPC	Vendor	CS/UOS	Location
80400132	9.25 oz	085199050210	DD-21	16/16	National

Very Berry Suet Cake

Very Berry suet cake is a of mixed with corn, sunflower seeds, seeds, berry flavoring and oats.



Item #	Desc	UPC	Vendor	CS/UOS	Location
80400133	9.25 oz	085199050227	DD-22	16/16	National

Fancy Blend Suet Cake

Fancy Blend suet is a of mixed sunflower seeds, grains and blueberry flavoring.



Item #	Desc	UPC	Vendor	CS/UOS	Location
80400131	9.25 oz	085199050203	DD-20	16/16	National

Bird's Blend Suet Cake

High energy blend perfect for year round feeding. Attracts these colorful songbirds: Cardinals, Chickadees, Goldfinches, Juncos, Kinglets, Nuthatches, Purple Finches, Siskins, Tanagers, Thrushes, Titmice, Warblers, Woodpeckers and Wrens. Guaranteed fresh.



Item #	Desc	UPC	Vendor	CS/UOS	Location
80400117	9.25 oz	085199042000	DD4-12	12/12	National



High Energy Suet Cake



Item #	Desc	UPC	Vendor	CS/UOS	Location
80400199	9.5 oz	085199042086	DD412A	16/16	National

Berry Blast Suet Cake

Heath Berry Blast Suet is produced by blending the highest quality natural ingredients available. Suet cakes are ideal for attracting colorful songbirds. Instructions for use: Place suet cake in suet cage and hang approximately 6ft off ground. Refill cage when empty.



Item #	Desc	UPC	Vendor	CS/UOS	Location
80400119	11.25 oz.	085199050159	DD-15	12/12	National

Peanut Crunch Suet Cake

Attract a variety of backyard birds with Heath's Peanut Crunch Suet Cake. The cake features a blend of suet, seeds and peanut pieces that will attract birds year round.



Item #	Desc	UPC	Vendor	CS/UOS	Location
80400120	11.25 oz.	085199050180	DD-18	12/12	National

Classic Double Suet Basket

Feeds twice as much as a standard suet cage. Holds two standard-sized suet cakes. Vinyl-coated weather-resistant metal cage. Front panel opens for quick and easy refilling. Attached hanging chain



Item #	Desc	UPC	Vendor	CS/UOS	Location
80400022	Suet Basket	085199080026	S-2	8/8	National

Green Metal Suet Feeders

Holds standard-sized suet or seed cake. Vinyl-coated metal cage is weather-resistant. Front panel opens for easy filling. Birds are able to feed from all surfaces. Hanging chain attached.



Item #	Desc	UPC	Vendor	CS/UOS	Location
80400021	Single	085199080019	S-1-8	24/24	National



Suet 'n Seed Animal Feeders

Item #	Desc	UPC	Vendor	CS/UOS	Location
80400278	Owl	085199217033	21703	5/5	East
80400284	Frog	085199218030	21803	5/5	East
80400283	Penguin	085199218023	21802	5/5	East

The Butterfly Bird Feeder

Holds 3 pounds of mixed seed. 4 feeding ports. Durable steel and plastic construction. Hammered silver color finish. Top unscrews for refilling and cleaning.



Item #	Desc	UPC	Vendor	CS/UOS	Location
80400181	Butterfly Feeder	085199212397	21239	4/4	National

Parkview Bird Feeder

Holds up to 1 pound of mixed seed. Durable steel and plastic construction for year-round feeding. 4 feeding ports around the base. Drainage holes help prevent water build-up and wasted seed. Top unscrews for refilling and cleaning.



Item #	Desc	UPC	Vendor	CS/UOS	Location
80400266	Antique White	085199215343	21534	4/4	National

Clementine Oriole Feeder

Feeds 2 orange halves, grape jelly, nectar or mealworms. Resembles an orange half. Durable UV-resistant powder-coated steel. Simplistic design offers a clear view of orioles as they feed. Glass cup removes for cleaning. Attached hanging chain.



Item #	Desc	UPC	Vendor	CS/UOS	Location
80400188	Oriole Feeder	085199131339	CF-133	6/6	National

Tube Seed Bird Feeders

Tube-style feeder. 6 feeding ports and holds up to 2 pounds of seed. Easy to clean and refill. Wire hanger included.



Item #	Desc	UPC	Vendor	CS/UOS	Location
80400040	Tube Feeder	085199003926	392	6/6	National

Giddy-Up Bird Feeder

Decorative tube feeder. Hammered copper finish. Holds 2 pounds of mixed seed. 4 feeding ports with perches. Top overhangs to help protect birds. Durable steel and plastic construction. Top unscrews for refilling and cleaning.



Item #	Desc	UPC	Vendor	CS/UOS	Location
80400038	Feeder	085199212304	21230	6/6	National

Grand Palace Bird Feeder

Feed the birds, not the squirrels. Intricate cage design helps protect against squirrels. Holds up to 1 pound of mixed seed. Durable steel and plastic construction for year-round feeding. 4 feeding ports within the safety of the cage. Top unscrews for refilling and cleaning.



Item #	Desc	UPC	Vendor	CS/UOS	Location
80400268	Grand Palace Feeder	085199215367	21536	2/2	National

SOURCING HAS NEVER BEEN THIS SIMPLE



One login connects you to the industry's broadest selection of products for growers and independent retailers!

PLACE YOUR ORDER TODAY AT WWW.GRIFFINS.COM

Hummer's Galore

Ant Moat



Item #	Desc	UPC	Vendor	CS/UOS	Location
82400010	Ant Moat	075792114204	MOAT	12/12	National

Bee Guard Replacement Base

Simply attach the screw on base to the bottle on your Hummers Galore Hummingbird Feeders. Pops apart for easy cleaning



Item #	Desc	UPC	Vendor	CS/UOS	Location
82400011	Bee Guard	075792440051	BEE	6/6	National

Nectar

Make Bird Watching the best by using the enticing Hummingbird nectar, all natural, no preservatives or artificial color.



Item #	Desc	UPC	Vendor	CS/UOS	Location
82400009	4 pack 16 oz.	075792100160	NEC	12/12	National



HUMMINGBIRD FEEDER

Glass bottle feeders screw into plastic base. Flowers are laser printed on plastic base.

Item #	Desc	UPC	Vendor	CS/UOS	Location
82400004	All American 16 oz.	075792220165	AA16	12/12	National
82400002	Vine 16 oz.	075792110169	VINE16	12/12	National
82400005	Blue Sky 16 oz.	075792330161	SKY16	12/12	National
82400008	Hibiscus 16 oz.	075792440167	HIB16	12/12	National
82400003	All American 32 oz.	075792220325	AA32	12/12	National
82400001	Vine 32 oz.	075792110329	VINE32	12/12	National
82400006	Blue Sky 32 oz.	075792330161	SKY32	12/12	National
82400007	Hibiscus 32 oz.	075792330321	HIB32	12/12	National

Farmhouse Vertical Feeder

Made with naturally insect and rot resistant premium cedar. Extra spacing to accommodate larger birds like Cardinals and Jays.
14"H x 7"W x 8.25"D



Item #	Desc	UPC	Vendor	CS/UOS	Location
82250098	2lb / 1.5qt	857505008648	WWLF1-DECO	4/4	National

Farmhouse Wren House

Made with naturally insect and rot-resistant premium cedar. Air vents allow for maximum air ventilation through wall and floor openings.
8.25"H x 7.25"W x 7.25"D



Item #	Desc	UPC	Vendor	CS/UOS	Location
82250096	Wren House	857505008662	WWLH2-DECO	4/4	National

Farmhouse Bluebird House

11"H x 6.75"W x 6"D



Item #	Desc	UPC	Vendor	CS/UOS	Location
82250097	Bluebird house	857505008679	WWLH3-DECO	4/4	National

Squirrel Shield Choice Metal Feeder

Keep squirrels off your feeder! Collapsing seed cover keeps squirrels from getting to your seed. 4 feeding seed ports, ideal for Mixed seed/Sunflower. Holds 3qts 20.25Hx7.83Wx7.83D



Item #	Desc	UPC	Vendor	CS/UOS	Location
82250006	Mixed Seed/ Sunflower 3 qt	850028089330	SPTUB-1	4/4	National

Farmhouse Hopper Bird Feeder

Holds 3qt Sunflower/Mixed seed and two suet bars 11"Hx12.5"Wx6"D



Item #	Desc	UPC	Vendor	CS/UOS	Location
82250099	2 Suet Cages	857505008655	WWLF2-DECO	4/4	National

Squirrel Shield Hopper Feeder

Add a splash of farmhouse charm to your backyard birding experience while keeping the squirrels at bay! Collapsing perches under the weight of a squirrel.
10.75"H x 10.63"W x 10.50"D



Item #	Desc	UPC	Vendor	CS/UOS	Location
82250011	Holds 5.8qt	850028089002	SPHOP-1	1/1	National

Farmhouse Tube Feeder

Unique hanger design connects to outside of tube, for the easiest filling and less seed spilling. Holds 2.8qt
17"H x 7"W x 7"D



Item #	Desc	UPC	Vendor	CS/UOS	Location
82250100	Brown	857505008952	WWWPRB-DECO	6/6	National
82250101	Silver	857505008723	WWW-MRS-DECO	4/4	National

Stained Glass Hopper Feeder

Stained glass style brings a unique and stylish look to your birding experience!
11"H x 12.5"W x 6"D



Item #	Desc	UPC	Vendor	CS/UOS	Location
82250095	Holds 3qts & 2 suet cages	850028089040	WWTF2-UV2	4/4	National

Decorative Suet Cage Bird Feeder - Single Cake

Add a touch of rustic floral charm to your birding experience with this decorative single suet cage bird feeder!
6.5"H x 6.69"W x 6.0"D



Item #	Desc	UPC	Vendor	CS/UOS	Location
82250128	1 Cake Cage	850028089729	WWSUET-2	6/6	National

Basic Suet Cage Bird Feeder - Single Cake

The simple design and durable construction of this single suet cage bird feeder will provide you with hours of birding enjoyment!
5"H x 4.75"W x 1.75"D



Item #	Desc	UPC	Vendor	CS/UOS	Location
82250127	1 Cake Cage	850028089712	WWSUET-1	6/6	National

Country Cottage Gazebo Bird Feeder

Country Cottage Gazebo bird feeder is perfect for accommodating larger birds like cardinals and jays. Bottom tray has drainage feature, that allows air to flow and water to drain. Great for sunflower and mixed seed. Has seed diverter to feeding tray for even distribution.
9.8"H x 6.25"W x 6.25"D Holds 1.56 quarts



Item #	Desc	UPC	Vendor	CS/UOS	Location
82250103	Cottage Sunflower Feeder	850028089262	GAZ-H1	4/4	National

Paisley Sky Gazebo Bird Feeder

Paisley print Gazebo style bird feeder that's perfect for accommodating larger birds like cardinals and jays. Bottom tray has drainage feature that allows air to flow and water to drain. Great for sunflower and mixed seed. Has seed diverter to feeding tray for even distribution.
11.3"H x 7.5"W x 7.5"D Holds 3.7 quarts



Item #	Desc	UPC	Vendor	CS/UOS	Location
82250104	Paisley Gazebo	850028089255	GAZ-D2	4/4	National

Garden Floral Easy Clean Tube Feeder

Plastic easy clean tube feeder
16.5"H x 7"W x 7"D



Item #	Desc	UPC	Vendor	CS/UOS	Location
82250063	Garden Floral Easy Clean Tube Feeder	850028089033	WP2-S	6/6	National

Fantasy Floral Easy Clean Tube Feeder

Plastic Fantasy Floral Easy-Clean tube feeder features easily removable ports for cleaning. The wide tube and unique hanger attachment enable easy refilling. Thistle seed inserts included too! Accommodates large birds like cardinals. Holds 2.8qts. 16.5"H x 7"W x 7"D



Item #	Desc	UPC	Vendor	CS/UOS	Location
82250064	Fantasy Floral Easy Clean Tube Feeder	850028089316	WWWP3-S	6/6	National

Vintage Blossom Decorative Glass Hummingbird Feeder

Easy fill and clean hummingbird feeder with two part base and removable flower feeding ports. Built in ant moat on top of feeder deters unwanted pests from reaching feed. Built in perches. Holds up to 20oz
10.5"H x 6.5"W x 6.5"D



Item #	Desc	UPC	Vendor	CS/UOS	Location
82250023	Red Blossom HB Feeder	085002808071	DGHF3	6/6	National

Charming Peony Decorative Glass Hummingbird Feeder

Easy fill and clean hummingbird feeder with two part base and removable flower feeding ports. Built in ant moat on top of feeder deters unwanted pests from reaching feed. Built in perches. Holds up to 20oz. 10.5"H x 6.5"W x 6.5"D



Item #	Desc	UPC	Vendor	CS/UOS	Location
82250022	Peony HB Feeder	850028089064	DGHF2	6/6	National



Cedar Bat House

Made with insect- and rot-resistant premium cedar. Landing kerfs for easy grip landing. Removable inserts for cleaning.



Item #	Desc	UPC	Vendor	CS/UOS	Location
82250082	Singe Chamber	850023007902	CWH10	2/2	National

Bluebird Box House

Cedar Bluebird Box House with easy clean out doors, and fledgling kerfs inside making it easy for young to climb out. 12" H x 5.5" W x 8" D



Item #	Desc	UPC	Vendor	CS/UOS	Location
82250079	Bluebird Box House	857907005597	CWH3	4/4	National

Cedar Wren Hanging Bird House

Wren house made of durable cedar material. Constructed with rust-free hardware. 8" x 9" x 8"



Item #	Desc	UPC	Vendor	CS/UOS	Location
82250078	Hanging Wren house	857907005580	CWH1	4/4	National



A



B



C

My First™ Bird House w/ Viewing Window (A)

Have more fun with this hands-on learning experience when you build and decorate My First Bird House together! Perfect for workshops, this Kit comes with easy to follow directions, 6 acrylic paints, 2 paintbrushes, coloring sheet, stickers, all wood pieces, and nails. Bird house is 9.75"H x 5.75"W x 6.75"D

Item #	Desc	UPC	Vendor	CS/UOS	Location
82250001	Bird house kit	857505008976	DIY-BIRD	8/8	National

My First™ Wren House (B)

Kit comes with easy to follow directions, 6 acrylic paints, 2 paintbrushes, coloring sheet, stickers, all wood pieces, and nails. Size kit box is 10.04"H x 5.2"W x 2.4" D

Item #	Desc	UPC	Vendor	CS/UOS	Location
82250002	Wren kit	857505008969	DIY-WREN	8/8	National

My First™ Pollinator House (C)

Have more fun with this hands-on learning experiences with your child when you build and decorate My First Pollinator House together! Perfect for pollinator workshops or pollinator week promotions! Kit comes with easy to follow directions, 6 acrylic paints, 2 paintbrushes, coloring sheet, stickers, nails, all wood and bamboo pieces. 10.12"H x 6"W x 2.4"D

Item #	Desc	UPC	Vendor	CS/UOS	Location
82250003	Pollinator kit	857505008983	DIY-BEE	8/8	National

Box Wren House

8"H x 5"W x 7"D



Item #	Desc	UPC	Vendor	CS/UOS	Location
82250077	Wren house	857505008778	WWTH4	4/4	National

Cedar Bluebird Viewing House

Cedar bird house with clear viewing window. Elevated rust free wire mesh floor aids in the management of blowfly infestation. Easy clean out doors, and fledgling kerfs inside making it easy for young to climb out. 12" H x 7.5" W x 8" D



Item #	Desc	UPC	Vendor	CS/UOS	Location
82250080	Cedar viewing house	857907005603	CWH4	4/4	National

Better Gardens Farmhouse Bee Barn

Bring a unique farmhouse look to your garden and increase plant health naturally with beneficial insect houses. 11"H x 6.9"W x 4.21"D



Item #	Desc	UPC	Vendor	CS/UOS	Location
82250055	Pollinator Barn	857505008952	PWH17	6/6	National

Better Gardens Farmhouse Bee Home

Naturally maintain and improve the health of the plants in your yard, landscape, or garden by attracting beneficial insects! Bamboo shoots offer a natural nesting location. 8.5"H x 5"W x 4.5"D



Item #	Desc	UPC	Vendor	CS/UOS	Location
82250051	Farmhouse Bee House	857505008907	PWH8	6/6	National

Traditional Window Hummingbird Feeder

Easy-Fill and Clean™ Window Hummingbird Feeder with suction cup mounting system. Three feeding stations with perches. Bee resistant dome shape of feeder lid creates space between nectar and deters bees and wasps. Holds up to 8oz 9"H x 8"W x 2.5"D



Item #	Desc	UPC	Vendor	CS/UOS	Location
82250028	Window HB Feeder	857505008259	TWF1	6/6	National



*Display pack pictured

Mason Jar Hummingbird Feeder

Easy-Fill and Clean™ Mason Jar Hummingbird Feeder. Dishwasher safe for even easier cleaning. Holds up to 6oz. 2.5"H x 4"W x 4"D

Item #	Desc	UPC	Vendor	CS/UOS	Location
82250024	Case pack of 6	857505008280	MJF1	6/6	National
82250025	Display pack of 9	857505008280	MJF1-TRAY	9/9	National

Decorative Top-Fill Glass Hummingbird Feeder

Easy fill and clean glass hummingbird feeder with floral perch space. All parts are easily removable and are dishwasher safe. Holds 13oz. Comes in giftable packaging.

9.8"H x 7"W x 5.25"D



Item #	Desc	UPC	Vendor	CS/UOS	Location
82250031	13oz Green	850028089217	DTHF2	4/4	National



Artisan Gravity Hummingbird Feeder

Artisan hummingbird feeders have a two part base and removable flower feeding ports to allow complete disassembly for the most thorough cleaning. Hummingbird feeder has perches and life like flower ports

Item #	Desc	UPC	Vendor	CS/UOS	Location
82250037	A Blush Crackle	857505008792	AGF1	4/4	National
82250039	B Sunny Day	857505008815	AGF3	4/4	National
82250038	C Spring Rain	857505008808	AGF2	4/4	National

Ribbed Rose Gravity Hummingbird Feeder

Unique design creates an easy-to-use hummingbird feeder combined with a one-of-a-kind look that will be a favorite for both you and the hummingbirds! Glass reservoir with 7 feeding ports, plastic base



Item #	Desc	UPC	Vendor	CS/UOS	Location
82250113	28 oz	850028089781	TGF5	6/6	National

Scarlet Swirl Gravity Hummingbird Feeder

Built-in hummingbird perches allow for more hummingbird perching space to maximize hummingbird viewing. Five flexible lifelike flower ports with leak free fit for maximum feeding comfort. 7.5"H x 6.5"W x 6.5"D Glass reservoir with plastic base



Item #	Desc	UPC	Vendor	CS/UOS	Location
82250112	20 oz	850028089774	TGF4	6/6	National



Ruby Visions Antique Glass Gravity Hummingbird Feeder

Attract more hummingbirds to your yard with this antique textured glass hummingbird feeder! Built-in continuous hummingbird perch ring allows more hummingbird perching space to maximize hummingbird viewing. 10"H x 5.5"W x 5.5"D



Item #	Desc	UPC	Vendor	CS/UOS	Location
82250116	25 oz	850028089873	ANTGHF6	6/6	National

Antique Glass Gravity Hummingbird Feeder

Easy-Fill and Clean™ Antique glass hummingbird feeder has a two part base and removable flower feeding ports to allow complete disassembly for the most thorough cleaning. Hummingbird feeder has perches, and bee resistant dome shaped feeder ports that deter bees and wasps. Holds 28oz. 9.77"H x 6.35"W x 6.35"D



Item #	Desc	UPC	Vendor	CS/UOS	Location
82250036	Antique HB Feeder	850028089309	ANTGHF2	6/6	National

Lilac Dreams Antique Glass Gravity Hummingbird Feeder

Attract more hummingbirds to your yard with this antique textured glass hummingbird feeder! Built-in continuous hummingbird perch ring allows more hummingbird perching space to maximize hummingbird viewing. 9.5"H x 5.5"W x 5.5"D



Item #	Desc	UPC	Vendor	CS/UOS	Location
82250115	29 oz	850028089866	ANTGHF5	6/6	National

Crimson Carnation Antique Glass Gravity Hummingbird Feeder

Attract more hummingbirds to your yard with this antique textured glass hummingbird feeder! Built-in continuous hummingbird perch ring allows more hummingbird perching space to maximize hummingbird viewing. 9"H x 5.5"W x 5.5"D



Item #	Desc	UPC	Vendor	CS/UOS	Location
82250118	22 oz	850049312066	ANTGHF12	6/6	National



National Audubon™ Classic Butterfly Feeder

83/4" Yellow Butterfly Feeder, features 4 feeding ports & a built-in ant guard. Comes with a removable hanging rod, 12oz. Nectar & fruit capacity.



Item #	Desc	UPC	Vendor	CS/UOS	Location
80440143	12 oz	715038305361	24158	6/6	National

Rustic Star Insect House

The multi chamber design of this Star Insect House attracts the largest variety of beneficial insects including lacewings and lady bugs to help reduce plant damage from pests like aphids and caterpillars. Solitary bees may also use this house, increasing pollination. Hang your insect house about 5' high near the area where you want increased pollination and harmful insect protection, like a garden, flower bed or bushes and trees that blossom. The dark rustic finish insect house is filled with natural materials and ready to hang.



Item #	Desc	UPC	Vendor	CS/UOS	Location
80440333	Star Insect House	093432287057	28705	6/6	National

Yard Hanger

Ideal for hanging larger bird feeders, hummingbird feeders, flower baskets, wind chimes, or garden ornaments. Holds up to 25 lbs.



Item #	Desc	UPC	Vendor	CS/UOS	Location
80440163	88"	715038302216	24288	3/3	National

Metal Deck Railing Bird Bath

An elegant deck mounted birdbath with a distinctive textured hammered copper finish.



Item #	Desc	UPC	Vendor	CS/UOS	Location
80440430	14" Dia.	093432238165	23816	3/3	National



Two Tone Bird Bath and Feeder

Bird baths with yard stakes. 8"- 2 of each color per case. Blue/Green Swirl and Yellow/Orange Swirl (8"D x18.5"H) 10"- 2 of each flower per case. Sunflower and Blue Wild Flower (8"Dx26"H)

Item #	Desc	UPC	Vendor	CS/UOS	Location
80161298	8" 2-Tone	093432829004	82900	4/4	National
80161300	10" Flower	093432829127	82912	4/4	National

A



B



Assorted Bird Baths

Bird bath stand is sold separately.

Item #	Desc	UPC	Vendor	CS/UOS	Location
80161302	A -16"	093432829059	82905	2/2	National
80161303	B -16"	093432829066	82906	2/2	National
80162037	19" Stand	093432829103	82910	6/6	National
80162038	24" Stand	093432829110	82911	6/6	National

Audubon Park Hummingbird Food Nectar

All natural coloring, no preservatives. Pre-measured packets for a no-fuss, no-mess easy feed experience. Orioles, tanagers and warblers enjoy it too.



Item #	Desc	UPC	Vendor	CS/UOS	Location
80161512	8 oz.	025845123462	24950	24/24	National

Strawberry Hummingbird Feeder

Strawberry shaped hummingbird bird feeder, with a removable base, easy to clean and fill, 4 feeding ports.



Item #	Desc	UPC	Vendor	CS/UOS	Location
80440253	40 oz.	047977009407	24126	4/4	National

Rustic Farmhouse Hummingbird Feeder

Glass hummingbird feeder with galvanized base. Holds 14oz



Item #	Desc	UPC	Vendor	CS/UOS	Location
80440306	Rustic Glass HB Feeder	093432287125	28712	6/6	National

Magnum Sunflower Screen Feeder

This hunter green Magnum® feeder is as durable as it is attractive. Easy to fill and clean with an easy-open top. 8½"D x 12½"H



Item #	Desc	UPC	Vendor	CS/UOS	Location
80440204	Sunflwr 3 lb.	715038398103	24500	4/4	National

Dragonfly Squirrel Proof Feeder

Four weight-activated perches shut off access to seed. Decorative dragonfly design above each perch may offer additional perching room. Twist lid to lock. Fill with 2-1/2 lbs. of seed. Easy to clean, simply press the two bottom tabs to release. Crafted from powder coated steel with an antique pewter finish. Clear polypropylene tube.



Item #	Desc	UPC	Vendor	CS/UOS	Location
80440240	Squirrel Proof Feeder	047977008059	23812	4/4	National

Small Ranch Feeder

Made From Handcrafted Natural Cedar. Comes With A Heavy Cable For Hanging.



Item #	Desc	UPC	Vendor	CS/UOS	Location
80440079	1.5 qt	715038313014	24007	2/2	National

National Audubon™ Traditional Wren House

Made of natural cedar and fir. Ventilated and easy to clean design. Built to Audubon specifications. Has a 1 1/8" hole. 6.8"D x 7.1"W x 6 1/4"H



Item #	Desc	UPC	Vendor	CS/UOS	Location
80440224	Wren	715038306580	24305	4/4	National

National Audubon™ Bluebird House

Made of natural cedar. Ventilated and easy to clean design. Built to Audubon specifications. Has a 1 9/16" hole. 6.4"D x 6.4"W x 11 3/4"H



Item #	Desc	UPC	Vendor	CS/UOS	Location
80440083	Bluebird	715038302025	24225	3/3	National



Rustic Farmhouse Feeders / Houses

Item #	Desc	UPC	Vendor	CS/UOS	Location
80440295	A Hopper feeder w/ Rooster accent holds 3lbs	093432287088	28708	2/2	National
80440298	B Ranch feeder w/ suet feeders holds 4lbs	093432287095	28709	1/1	National
80440294	C Wren House 7.25"x7.25"x6.5"	093432287101	28710	4/4	National

National Audubon™ Bat Shelter

Handcrafted of natural cedar. Provides capacity for up to 20 bats. 12"W x 4 1/2"D x 15.9"H



Item #	Desc	UPC	Vendor	CS/UOS	Location
80440087	Bat House	715038302186	24228	1/1	National

Rustic Farmhouse Silos

Top selling Rustic Farmhouse Silo bird feeders. Holds .5lbs of seed



Item #	Desc	UPC	Vendor	CS/UOS	Location
80440302	Sunflower	093432287132	28713	6/6	National
80440300	Nyjer	093432287163	28716	6/6	National



FAST-TRACK YOUR PLANT SALES

Cut crop time with quick finish liners or pre-finished plants from Griffin. Our young-plant network serves all major regions of the country with quality material and reliable fill rates. Contact your Griffin sales representative or browse current availability on griffins.com.





Birdhouses

A chain and hook come included for easy installation and easy move in for your feathered friends.

Item #	Desc	UPC	Vendor	CS/UOS	Location
80230434	A Deco Birdhouse Bungalow 6/cs	759834560197	56019	6/6	National
80230431	B Deco Birdhouse Raindrop 6/cs	759834560265	56026	6/6	National
80231405	C Birdhouse Log House 6/cs	759834560142	56014	6/6	National
80230555	D Birdhouse Woven Maison Med. 6/cs	759834560524	56052	6/6	National
80230121	E Birdhouse Woven Raindrop 6/cs	759834560104	56010	6/6	National
80230594	F Woven Raindrop Med. Wicker 6/cs	759834560500	56050	6/6	National
80231201	G Woven Raindrop Med. 6/cs	759834560517	56051	6/6	East
80230120	H Birdhouse Woven Maison 6/cs	759834560128	56012	6/6	National
80230422	I Birdhouse Woven Bungalow Large 6/cs	759834560135	56013	6/6	National
80230556	J Birdhouse Woven Bungalow Med. 6/cs	759834560609	56053	6/6	National
80230689	K Bird Feeder Dove 7" Small 6/cs	759834569008	56900	6/6	East
80230690	K Bird Feeder Dove 9.5" Large 6/cs	759834569015	56901	6/6	East
80230691	L Bird Feeder Sparrow 7" Small 6/cs	759834569022	56902	6/6	National
80230692	L Bird Feeder Sparrow 9.5" Large 6/cs	759834569039	56903	6/6	National
80230686	M Birdhouse Woven Gazebo 6/cs	759834560012	56001	6/6	National
80230432	N Deco Birdhouse Shack 6/cs	759834560159	56015	6/6	National
80230781	O Birdhouse Plantable Maison 6/cs	759834560029	56002	6/6	National
80230433	P Deco Birdhouse Maison 6/cs	759834560364	56036	6/6	West



Butterfly Ready-To-Use Nectar

All-natural, dye-free, citrus and wildflower-infused ready-to-use butterfly nectar. Fortified with calcium to promote healthy egg development and electrolytes to aid in the prevention of dehydration. No unnecessary food coloring or harmful preservatives.



Item #	Desc	UPC	Vendor	CS/UOS	Location
82180018	250 ml	632726256173	B-BRTU-250	12/12	National
82180006	750 ml	712038079698	N-BRTU	12/12	National

Hummingbird Nectar Concentrate

All-natural, dye-free, wild flowerinfused hummingbird nectar concentrate (makes 3X). Fortified with calcium to promote healthy egg development and electrolytes to aid in the prevention of dehydration. No unnecessary food coloring or harmful preservatives.



Item #	Desc	UPC	Vendor	CS/UOS	Location
82180001	750ml Glass Bottle	661799213745	N-HCON	12/12	National
82180007	Bag 1.5L	712038079612	B-HCON-M	4/4	National

Oriole Concentrate Nectar

A great way to make your nectar last! Clear oriole nectar concentrate infused with citrus.



Item #	Desc	UPC	Vendor	CS/UOS	Location
82180003	750 ml	661799213714	N-OCON	12/12	National

Butterfly Concentrate Nectar

Create your very own backyard butterfly sanctuary by offering up feeders filled with Sweet-Nectar all natural butterfly nectar. Our blend is infused with a proprietary blend of the all natural fruit and flower extract most loved by a wide variety of butterflies.



Item #	Desc	UPC	Vendor	CS/UOS	Location
82180005	750 ml	045635082427	N-BCON	12/12	National

Hummingbird Nectar Powder Concentrate

All-natural, dye-free powder hummingbird nectar concentrate (makes over 1 liter). Fortified with calcium to promote healthy egg development and electrolytes to aid in the prevention of dehydration. No unnecessary food coloring or harmful preservatives.



Item #	Desc	UPC	Vendor	CS/UOS	Location
82180021	8 oz	632726256371	P-HCON-8	12/12	National



Hummingbird Ready-To-Use Nectar

All-natural, dye-free, wildflower-infused ready-to-use hummingbird nectar. Fortified with calcium to promote healthy egg development and electrolytes to aid in the prevention of dehydration. No unnecessary food coloring or harmful preservatives.

Item #	Desc	UPC	Vendor	CS/UOS	Location
82180012	250 ml Pouch	712038203741	B-HRTU-250	12/12	National
82180002	750ml Glass Bottle	045635922730	N-HRTU	12/12	National
82180011	Bag 1.5L	712038079636	B-HRTU-M	4/4	National

Oriole Ready-To-Use Nectar

All-natural, dye-free, citrus-infused ready-to-use oriole nectar. Fortified with calcium to promote healthy egg development and electrolytes to aid in the prevention of dehydration. No unnecessary food coloring or harmful preservatives.



Item #	Desc	UPC	Vendor	CS/UOS	Location
82180015	250 ml Pouch	632726256296	B-ORTU-250	12/12	National
82180004	750ml Glass Bottle	712038079711	N-ORTU	12/12	National
82180014	Bag 1.5L	632726256234	B-ORTU-M	4/4	National



Round Bird Bath

White resin birdbath. 22" x 17" x 31". Made of durable weather resistant plastic. Top needs to be assembled to base with 3 provided screws.



Item #	Desc	UPC	Vendor	CS/UOS	Location
81320048	White	78304610102	61010	6/6	East



Pink Finch Sock

The Wild Delight® Finch Sock Feeder is an all-in-one feed and feeder that contains only the finest premium grade Nyjer® Seed*, an oil seed preferred by finches and other birds.



Item #	Desc	UPC	Vendor	CS/UOS	Location
82100065	13 oz	719195383040	383040	12/12	National

Bugs For Birds

Feed alone or mix with your favorite wild bird food. Attracts and feeds bluebirds, nuthatches, chickadees, grosbeaks, woodpeckers, titmice and other insect-eating outdoor birds. Contains Mealworms, Soldier Fly Larvae and Darkling Beetles.



Item #	Desc	UPC	Vendor	CS/UOS	Location
82100009	16 oz	719195367866	367866	6/6	National

Mealworms

Feed alone or mix with your favorite wild bird food. Attracts and feeds bluebirds, nuthatches, chickadees, grosbeaks, woodpeckers, titmice and other insect-eating outdoor birds.



Item #	Desc	UPC	Vendor	CS/UOS	Location
82100008	16 oz	719195367811	367816	6/6	National

Feast for Wild Birds

A wholesome, natural wild bird food containing millet, safflower and black oil sunflower seeds.



Item #	Desc	UPC	Vendor	CS/UOS	Location
82100056	5 lb	719195371054	371050	8/8	National

Striped Sunflower Seeds

A premium striped sunflower seed selected for high oil and nutrient content. Striped sunflowers contain less oil than black oil sunflowers, but provide variety for seed-eating birds.



Item #	Desc	UPC	Vendor	CS/UOS	Location
82100076	15 lb	719195363158	363150	1/1	National

Shelled Peanuts

An all-natural food source for all wild birds and wildlife, Wild Delight® shelled peanuts are premium grade, unprocessed, uncooked and not salted. Woodpeckers, Jays, Doves, Songbirds, Squirrels, Chipmunks, Ducks and other outdoor pets



Item #	Desc	UPC	Vendor	CS/UOS	Location
82100054	10 lb	719195380056	380050	4/4	National

Safflower Seed

This premium-select, high-oil seed is preferred by cardinals. Normally, squirrels, jays, starlings and grackles will not eat safflower seed due to its bitter taste.



Item #	Desc	UPC	Vendor	CS/UOS	Location
82100077	8 lb	719195386089	386080	4/4	National



Buffet Wild Bird Food

A wholesome, natural wild bird food for all seed-eating birds.



Item #	Desc	UPC	Vendor	CS/UOS	Location
82100059	10 lb	719195391106	391100	4/4	National
82100060	20 lb	719195391205	391200	1/1	National

Corn On The Cob

A premium corn on the cob. Squirrels, ducks, geese, raccoons and other wildlife. Squirrels, ducks, geese, raccoons and other wildlife.



Item #	Desc	UPC	Vendor	CS/UOS	Location
82100050	7 lb	719195388076	388070	4/4	National

Black Oil Sunflower Seeds

A premium black oil sunflower seed selected for high oil and nutrient content for all seed-eating birds.



Item #	Desc	UPC	Vendor	CS/UOS	Location
82100072	5 lb	719195596051	361050	6/6	National
82100074	20 lb	719195361208	361200	1/1	National

Golden Finch Food

A premium outdoor bird food blended to attract finches and buntings, filled with ingredients these birds love and touched with hues of harvest gold. Attracts and feeds American goldfinches, house finches, purple finches, buntings, chickadees, nuthatches and other outdoor birds



Item #	Desc	UPC	Vendor	CS/UOS	Location
82100013	5 lb	719195373058	373050	6/6	National

Nyjer Seed

A cleaned, premium-grade thistle that has been sterilized to prevent germination. American Goldfinches, Purple Finches, House Finches, Cassin's Finches, Pine Siskins and Redpolls.



Item #	Desc	UPC	Vendor	CS/UOS	Location
82100068	5 lb	719195383057	383050	6/6	National

Outdoor Finch Food

A special blend of premium ingredients for finches. American goldfinches, house finches, purple finches, chickadees, song sparrows, indigo buntings, exotic parakeets and more.



Item #	Desc	UPC	Vendor	CS/UOS	Location
82100062	5 lb	719195375052	375050	6/6	National

Crunch N' Nut Squirrel Food

A special blend of premium ingredients for squirrels and other backyard wildlife. Squirrels, chipmunks, rabbits, raccoons, ducks, geese, elk, moose, antelope and other outdoor wildlife.



Item #	Desc	UPC	Vendor	CS/UOS	Location
82100045	8 lb	719195362083	362080	4/4	National
82100046	20 lb	719195362205	362200	1/1	National

Deck Porch N' Patio

An elite, zero-waste wild bird food blended to attract the most desired outdoor birds and give you the cleanest feeding experience available for your outdoor living areas. Attracts all feeder songbirds, including cardinals, grosbeaks, finches, jays, nuthatches and other outdoor birds.



Item #	Desc	UPC	Vendor	CS/UOS	Location
82100014	5 lb	719195374055	374050	6/6	National
82100015	20 lb	719195374208	374200	1/1	National



Fruit N' Berry

A premium 5 fruit blend wild bird food blended to attract and feed the most desirable outdoor birds. Songbirds, cardinals, grosbeaks, finches, jays, thrushes, buntings and other outdoor birds.



Item #	Desc	UPC	Vendor	CS/UOS	Location
82100026	5 lb	719195365053	365050	6/6	National
82100027	20 lb	719195365206	365200	1/1	National

Woodpecker Nuthatch N' Chickadee

A premium wild bird food blended to attract and feed the most desirable outdoor birds. Woodpeckers, wild parrots, parakeets, nuthatches, chickadees, jays and other outdoor birds.



Item #	Desc	UPC	Vendor	CS/UOS	Location
82100016	5 lb	719195364056	364050	6/6	National

Gourmet Outdoor Food

A premium wild bird food blended to attract and feed the most desirable outdoor birds. Buntings, juncos, cardinals, nuthatches, chickadees, finches, jays, titmice, grosbeaks, doves and other outdoor birds.



Item #	Desc	UPC	Vendor	CS/UOS	Location
82100023	8 lb	719195368085	368080	4/4	National

Cardinal Food

A premium wild bird food blended to attract and feed the most desirable outdoor birds. Cardinals, songbirds, titmice, grosbeaks, thrushes, jays and other outdoor birds.



Item #	Desc	UPC	Vendor	CS/UOS	Location
82100018	7 lb	719195376073	376070	4/4	National
82100019	15 lb	719195376158	376150	1/1	National

Nut N' Berry

Wild Delight's number 1 selling blend! It contains everything a bird a can want – Sunflower Kernels, Peanuts, Sunflower Seed, Safflower Seed, Pistachios, Pistachios, Dried Raisins, Dried Cranberries, and of course, all the vitamins, minerals and electrolytes Wild Delight Premium Feeds are known for. Treat your birds to something special!



Item #	Desc	UPC	Vendor	CS/UOS	Location
82100030	5 lb	719195366050	366050	6/6	National
82100031	20 lb	719195366203	366200	1/1	National

Songbird Food

A premium wild bird food blended to attract and feed the most desirable outdoor birds. Grosbeaks, finches, cardinals, doves, nuthatches, thrushes, songbirds and other outdoor birds.



Item #	Desc	UPC	Vendor	CS/UOS	Location
82100021	8 lb	719195377087	377080	4/4	National

Sizzle N' Heat

A premium hot blend designed for BIRDS ONLY. Cardinals, finches, nuthatches, jays, chickadees, titmice, grosbeaks and other outdoor birds.



Item #	Desc	UPC	Vendor	CS/UOS	Location
82100034	11.8oz Suet	719195372174	372175	12/12	National
82100011	5 lb	719195372051	372050	6/6	National
82100012	14 lb	719195372143	372140	3/3	National

Special Finch Food

A premium Finch food blended with the seeds that America's favorite Finches love. American goldfinches, purple finches, house finches, chickadees, nuthatches, titmice, and other outdoor birds.



Item #	Desc	UPC	Vendor	CS/UOS	Location
82100032	5 lb	719195381053	381050	6/6	National



Zero Waste Fruit Blend

An elite, zero-waste wild bird food blended with fruit to attract the most desired outdoor birds and give you the cleanest feeding experience.



Item #	Desc	UPC	Vendor	CS/UOS	Location
82100028	5 lb	719195360058	360050	6/6	National

Bugs N' Berries

A premium wild bird food containing our unique three-bug blend and berries. Bluebirds, Grosbeaks, Finches, Titmice and other insect-eating outdoor pets.



Item #	Desc	UPC	Vendor	CS/UOS	Location
82100010	4.5 lb	719195367842	367845	6/6	National

Zero Waste Food

Better Bird Better Blends contain only the ingredients that desired backyard birds love. This helps to ensure they eat more seed at your feeder instead of tossing it on the ground. You save money by not paying for wasted product. A shell-free blend that attracts the most desirable wild birds while helping to keep yards free of leftover waste



Item #	Desc	UPC	Vendor	CS/UOS	Location
82100082	5 lb.	719195642550	642550	6/6	National

Beautiful Bird Food

Better Bird provides maximum nutrition for a variety of wild birds and caged birds. Each product is uniquely cleaned and virtually dust-free. We use premium ingredients to formulate each blend. Wild bird products are packed in special packaging and provide superior nutrition for all types of Songbirds, Finches and other outdoor pets.



Item #	Desc	UPC	Vendor	CS/UOS	Location
82100005	5 lb.	719195640051	640050	6/6	National
82100006	17 lb.	719195640174	640170	1/1	National

Squirrel Away Food

Bird food formula designed to keep squirrels away, while giving your wild birds the food they will love. Ingredients include Capsaicin, which is derived from hot peppers and acts as a squirrel deterrent.



Item #	Desc	UPC	Vendor	CS/UOS	Location
82100081	5 lb.	719195632550	632550	6/6	National

Songbird Food

Bird food formulated to attract a wide assortment of desired songbirds. High energy blend made from premium ingredients designed to provide maximum nutrition for a variety of wild birds.



Item #	Desc	UPC	Vendor	CS/UOS	Location
82100003	5 lb.	719195630052	630050	6/6	National
82100004	17 lb.	719195630175	630170	1/1	National

Finch Food

Finch Wild Bird Food is a better way to feed your birds. It is a blend of Nyjer Seed (Guizotia Abyssinica), Sunflower Kernels, Millet, Canary Grass Seed. It attracts goldfinches, purple finches, house finches, buntings and other outdoor birds.



Item #	Desc	UPC	Vendor	CS/UOS	Location
82100002	4 lb.	719195650043	650040	6/6	National

WORLD SOURCE PARTNERS



Woven Rope Roosting Pockets

These roosting pockets provide cozy roosting and resting places for all small birds. Woven natural grass-rope and natural hangers. Dimensions: A - 6"x6"x9" B - 6"x6"x11" C - 6"x6"x8"

Item #	Desc	UPC	Vendor	CS/UOS	Location
81730396	A Pocket w/ Roof	745487052011	BA05201	25/25	National
81730398	B Acorn w/ Roof	745487052035	BA05203	25/25	National
81730399	C Hive	745487052042	BA05204	25/25	National

KIDS GARDENING



CHECK OUT OUR
CLEARANCE ITEMS!



Griffin Greenhouse Retail WAREHOUSE Shipping Map

We are now shipping nationwide!

NATIONAL



2024

Refer to location key:

National items are stocked nationally
 Select items are sold East or West only; no exceptions

8" Kaleidoscope Planter

Premium plastic modular planter can be displayed individually each planter has a removable saucer ideal for succulents or shallow rooted planted.

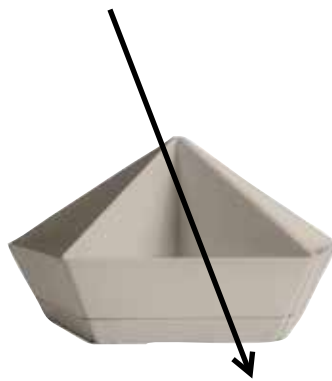

Item #	Desc	UPC	Vendor	CS/UOS	Location
80282643	Vanilla Bisque	770932844170	KDP08000A58	6/6	National

Where is the pricing?

1. Scan QR code on Chapter Pages to see pricing on Griffins.com
2. Contact your Griffin Sales Representative
3. Call into Griffin Customer Service 800.888.0054





FAIRY GARDEN KITS

Easily design a miniature garden scene and step into a world of fantasy. Fairy gardens are miniature gardens complete with structures and living plants limited only by the imagination. These kits include multiple handcrafted pieces and make it easy for children and adults to design unique and delightful gardens.



Tea Party Fairy Garden Kit contains:

- (1) Tea Pot Cottage
- (1) Fairy with Tea
- (1) Tree Trunk Table
- (2) Tree Trunk Chairs
- (3) Lattice Fences
- (1) Welcome Sign
- (1) Tea Set
- (1) Pair Hedgehogs

Item #	Desc	UPC	Vendor	CS/UOS	Location
80690701	Tea Party	849637004735	FG31	12/12	East



Adoring Acorns Fairy Garden Kit contains:

- (1) Acorn House
- (1) Fairy with Acorn Hat
- (1) Acorn Bench
- (3) Log Fences
- (3) Birdhouse Stakes
- (1) Squirrel
- (1) Tree Slab Pathway

Item #	Desc	UPC	Vendor	CS/UOS	Location
80690702	Adoring Acorns	849637004742	FG32	12/12	East



Face of the Forest Planter

Adding elements of fantasy and wonder to an area is easy with this durable planter for trees, walls, or fences. Whether using the whimsical face-shaped planter as a decorative container for growing and displaying live plants, or as a tree spirit embellishment to enrich the imaginative tone of your outdoor space, this functional planter brings a sprinkle of merriment and a hint of tranquility.

Item #	Desc	UPC	Vendor	CS/UOS	Location
80691011	Willow 8x10.5"	849637009402	TF01	4/4	East
80691012	Elderberry 8x11.8"	849637009419	TF02	4/4	East
80691013	Hawthorn 7.5x11.8"	849637009426	TF03	4/4	East

We collect food waste from our local communities and recycle it into plant food. The Project was developed to provide job skills training and opportunities for individuals with disabilities, as well as repurposing food waste into a usable product.

Desc	Size	Item #	Location
5-0-6 All Purpose Fertilizer	2 lb	82190003-746	East
4-0-4 Hydrangea Fertilizer	2 lb	82190001-746	East
5-0-6 Tomato Fertilizer	2 lb	82190002-746	East

**Available for sale in CT, MA, ME, NH, NY, RI, & VT*



Ducky Glove for Kids

This glove is already making a splash. Bright yellow nylon knit with bright orange nitrile 3/4 dip coating. Kids can use it as a puppet, too. Durable, washable, and lots of fun!

Item #	Desc	UPC	Vendor	CS/UOS	Location
80090032	Kids	639751105254	C1052T	12/12	National

2024



Kid Tuff Too™

These colorful, washable gloves will be instant winners with kids and the adults who like to buy things for them! Nylon knit with textured rubber palm, three assorted characters for each size.

Item #	Desc	UPC	Vendor	CS/UOS	Location
80090214	XS	639751237054	KT440ACXS	12/12	National
80090811	Toddler	639751237108	KT440ACT	12/12	National
80090812	XXS	639751237184	KT440ACXXS	12/12	National



Wonder GRIP for Kids!

Textured nitrile palm coating on an ultra-lightweight seamless nylon knitted glove in a size for children. Three assorted colors.

Item #	Desc	UPC	Vendor	CS/UOS	Location
80090215	XS	639751239652	KWG515ACXS	12/12	National

Coast of Maine

Bar Harbor Blend™ Organic & Natural Potting Soil

Our great all-purpose potting soil is made with natural and organic ingredients such as lobster, kelp, compost, perlite, and sphagnum peat. It is designed for potting indoor and outdoor container plants. Water and fertilize less with this nutrient rich, compost based potting soil. OMRI Listed.



Item #	Desc	UPC	Vendor	CS/UOS	Location
81600011	8 qt.	609853000948	BH4501	6/6	East



Kids Wheelbarrow

Kids Poly Wheelbarrow Red Perfect for kids to outdoor yard work.



Item #	Desc	UPC	Vendor	CS/UOS	Location
81380709	Kids Wheelbarrow	038313110024	KD 1002	4/4	East

Kids Garden Tool Set

Kids can work right along side their Parents and experience the thrills of gardening 3pc tools set Shovel. Rake, Hoe in Red



Item #	Desc	UPC	Vendor	CS/UOS	Location
81380708	3 Piece	038313368418	KD 1001	18/18	National



CEMENT BUDDIES

Forest animal planters | Adorable addition to any home or garden.



Item #	Desc	Vendor	UOS/CS	Location	Item #	Desc	Vendor	UOS/CS	Location	Item #	Desc	Vendor	UOS/CS	Location
Bird - S: 6.25" x 4" x 4.75" / L: 8.75" x 5.25" x 5.5"					Owl: 4.5" x 4.25" x 4.75" / L: 5.5" x 5" x 6"					Sleeping Cat - S: 7" x 4.75" x 4" / L: 8" x 5.75" x 4.5"				
81791016	Rust - S	9/3411R/1	12/12	National	81791573	Rust - S	260006P-433	12/12	National	81791575	Rust - S	260010P-433	12/12	National
81791017	Nat - S	9/3411/1	12/12	National	81791565	Nat - S	260006P-396	12/12	National	81791567	Nat - S	260010P-396	12/12	National
81791018	Rust - L	9/3412R/1	6/6	National	81791572	Rust - L	260005P-433	8/8	National	81791574	Rust - L	260009P-433	6/6	National
81790079	Nat - L	9/3412/1	6/6	National	81791564	Nat - L	260005P-396	8/8	National	81791566	Nat - L	260009P-396	6/6	National
Elephant - 7" x 5" x 6"					Piglet - S: 6" x 3.75" x 3.5" / L: 7.5" x 4.75" x 4"					Sleeping Dog: 7" x 6.25" x 3.25"				
81791571	Rust	260004P-433	8/8	National	81791578	Rust - S	260014P-433	12/12	National	81791576	Rust - S	260011P-433	6/6	National
81791563	Natural	260004P-396	8/8	National	81791570	Nat - S	260014P-396	12/12	National	81791568	Nat - S	260011P-396	6/6	National
Frog - S: 5.75" x 4.75" x 4" / L: 7.5" x 6" x 5.5"					Rabbit - S: 6" x 4.75" x 3.75" / L: 8" x 6" x 4.5"					Snail - S: 5.75" x 4.5" x 4.25" / L: 8" x 6" x 5.5"				
81791027	Rust - S	9/3431R/1	18/18	National	81791019	Rust - S	9/3441R/1	12/12	National	81791031	Rust - S	9/3471R/1	12/12	National
81791028	Nat - S	9/3431/1	18/18	National	81790089	Nat - S	9/3441/1	12/12	National	81791032	Nat - S	9/3471/1	12/12	National
81791029	Rust - L	9/3432R/1	8/8	National	81791020	Rust - L	9/3442R/1	6/6	National	81791033	Rust - L	9/3472R/1	4/4	National
81791030	Nat - L	9/3432/1	8/8	National	81790088	Nat - L	9/3442/1	6/6	National	81790076	Nat - L	9/3472/1	4/4	National
Hedgehog - S: 5" x 4.25" x 3" / L: 7.75" x 6" x 4.25"					Turtle - S: 6" x 4.75" x 3.5" / L: 7.75" x 6" x 4.5"									
81791021	Rust - S	9/3431R/1	18/18	National	81791024	Rust - S	9/3451R/1	12/12	National	81791025	Nat - S	9/3451/1	12/12	National
81791022	Nat - S	9/3431/1	18/18	National	81791026	Rust - L	9/3452R/1	6/6	National	81790077	Nat - L	9/3452/1	6/6	National
81791023	Rust - L	9/3432R/1	8/8	National	<i>All animals have removable drainage plugs!</i>									
81790078	Nat - L	9/3432/1	8/8	National										



4" WindyWings™ Mixed Assorted Shelf Display

Each stake is 13" tall. 24 piece mixed assortment in a plastic pot display. Includes (6 each): 4" butterflies, 4" dragonflies, 4" hummingbirds and 4" song birds. Comes fully assembled. Already positioned in a plastic pot. 95% plastic and 10% metal. 6" x 4.5" x 16"



Item #	Desc	UPC	Vendor	CS/UOS	Location
80870001	24pc assortment	093335050352	5035	24/24	National

7" WindyWings Assorted Wind Chimes

The vivid bright hues, the lovely sounds of the soothing chimes through the gentle breeze, and the "springed" wings that add whimsical motion, make this beautiful piece of garden art a delightful decorative accent to any home or yard! Hand painted with a special lacquer coating to protect the colors and provide a high-gloss shine. 4"x 8"x 21".



Item #	Desc	UPC	Vendor	CS/UOS	Location
80870436	24pc assortment	093335401048	40104	24/24	National



Leader in Horticultural Containers



Sprite Succulent Pot

Plastic succulent planter has the look of ceramic and concrete without the fragility. Features a drain hole for proper succulent drainage and care.

Item #	Desc	UPC	Vendor	CS/UOS	Location
80282495	2.5" Vanilla Bisque	770932840790	SSP02500A58	20/20	National
80282496	2.5" Artisan Taupe	770932840813	SSP02500E67	20/20	National
80282497	2.5" Faux Concrete	770932840837	SSP02500G28	20/20	National
80282851	2.5" Faux Turquoise	770932844149	SSP02500K22	20/20	National
80282850	2.5" Blush	770932844125	SSP02500K21	20/20	National
80282498	3" Vanilla Bisque	770932840806	SSP03000A58	20/20	National
80282499	3" Artisan Taupe	770932840820	SSP03000E67	20/20	National
80282500	3" Faux Concrete	770932840844	SSP03000G28	20/20	National
80282898	3" Faux Concrete/Copper	770932841360	SSP03000K-20C040LRCOY	40/40	National
80282859	7" Vanilla Bisque	770932844057	SSP07000A58	12/12	National



Gnome Watering Can

"Gnute the Gnome" Novelty's gnome watering can stands tall as a sentry over the garden. This 1.5-gallon can is sure to be a classic piece of garden art. 100% recyclable.



Item #	Desc	UPC	Vendor	CS/UOS	Location
80250488	1.5 gal.	026978309013	30901	10/10	National



Babs - Pig Watering Can

Babs, Novelty's affable pig watering can, holds 1 3/4 gal. of water. Kids and pig lovers alike adore this fine swine watering vessel.

Item #	Desc	UPC	Vendor	CS/UOS	Location
80250029	Pink 1 3/4 gal.	026978305008	30500	10/10	National

Squirt - Fish Watering Can

The fish are flying at Novelty. Making a big splash at the pool, beach or in the garden, Squirt, watering can, appeals to "kids" of all ages. Keeping our earth and waters eco-friendly, Novelty watering cans are recyclable.

Item #	Desc	UPC	Vendor	CS/UOS	Location
80250030	Orange 3/4 gal	026978308061	30806	6/6	National

Lucky Duck Watering Can

With a comfortable handle and easy pouring features, this one gallon darling is a winner.

Item #	Desc	UPC	Vendor	CS/UOS	Location
80250486	Yellow 1 gal.	026978301048	30104	6/6	National

EarthBox® Junior™ Organic Garden Kit

This compact-sized EarthBox® Junior™ is just like the original EarthBox® gardening system, with the same smart technology, but approximately half the size and specifically designed for smaller spaces. EarthBox® Junior™ is the perfect size for growing a kitchen herb garden and is ideal as a pretty window box with flowers. 23in L x 9.5in W x 7.25in H



Item #	Desc	UPC	Vendor	CS/UOS	Location
80250629	Green Kit	026978806512	80651	6/6	National
80250630	Terra Cotta Kit	026978806550	80655	6/6	National



A



B



C

My First™ Bird House w/ Viewing Window (A)

Have more fun with this hands-on learning experience when you build and decorate My First Bird House together! Perfect for workshops, this Kit comes with easy to follow directions, 6 acrylic paints, 2 paintbrushes, coloring sheet, stickers, all wood pieces, and nails. Bird house is 9.75"H x 5.75"W x 6.75"D

Item #	Desc	UPC	Vendor	CS/UOS	Location
82250001	Bird house kit	857505008976	DIY-BIRD	8/8	National

My First™ Wren House (B)

Kit comes with easy to follow directions, 6 acrylic paints, 2 paintbrushes, coloring sheet, stickers, all wood pieces, and nails. Size kit box is 10.04"H x 5.2"W x 2.4" D

Item #	Desc	UPC	Vendor	CS/UOS	Location
82250002	Wren kit	857505008969	DIY-WREN	8/8	National

My First™ Pollinator House (C)

Have more fun with this hands-on learning experiences with your child when you build and decorate My First Pollinator House together! Perfect for pollinator workshops or pollinator week promotions! Kit comes with easy to follow directions, 6 acrylic paints, 2 paintbrushes, coloring sheet, stickers, nails, all wood and bamboo pieces. 10.12"H x 6"W x 2.4"D

Item #	Desc	UPC	Vendor	CS/UOS	Location
82250003	Pollinator kit	857505008983	DIY-BEE	8/8	National



Mini Hanging Animals

3" Mini hanging animals. Hang on the side of your favorite planter! Assorted PDQ displays easily on shelves or counter tops. Ceramic turtle, frog and hedgehog.



Item #	Desc	UPC	Vendor	CS/UOS	Location
81510430	Hanging Asst. Animals	38858606662	7898-12-1315	12/12	National



Mini Terracotta Animal Planters

Height range: 2½"-3" (elephant & llama heads up to 6"). Opening: 2"-2½". Assorted PDQ displays easily on shelves or counter tops. Terracotta llama, turtle, elephant and hedgehog.

Item #	Desc	UPC	Vendor	CS/UOS	Location
81510428	Terracotta Asst. Planters	038858606624	7896-12-1295	12/12	National



Mini Ceramic Animal Planters

Height range: 2½"-3½". Opening: 2"-2½". Assorted PDQ displays easily on shelves or counter tops. Ceramic llama, turtle, elephant and hedgehog.

Item #	Desc	UPC	Vendor	CS/UOS	Location
81510429	Ceramic Asst. Planters	038858606648	7897-12-1305	12/12	National





Butterfly Clips

SuperMoss Orchid and Plant Clips are a garden staple. They're perfect for orchids, vines, and climbing plants' not to mention air!



Item #	Desc	UPC	Vendor	CS/UOS	Location
80230200	10 pack	759834905448	90544	12/12	East



Kids Watering Can

Kids can water plants like grown ups with these brightly colored watering cans. 16 piece assorted case pack, four of each color, pink, green, blue, and orange. 9"W x 3.5"D x 6"H



Item #	Desc	UPC	Vendor	CS/UOS	Location
81550084	Kids Metal Watering Cans	017783050702	5070	16/16	National

1 pt. Mini Plastic Watering Can

Kids can easily water plants. Great for indoor plants too. 10"W x 2.75"D x 5.5"H



Item #	Desc	UPC	Vendor	CS/UOS	Location
81550539	1pt. Green	400278950017	5001G	15/15	National
81550538	1pt. Blue	400278950015	5001B	15/15	National
81552204	1pt. Pink	4027371121246	5001P	15/15	National



Kids Pails

Children can easily make sand castles, carry water, and toys. 16 piece assorted case pack, four of each color, pink, green, blue, and orange. 7.25"W x 7.25"D x 6"H

Item #	Desc	UPC	Vendor	CS/UOS	Location
81550085	Kids Metal Pails	017783050801	5080	16/16	National



Little Pals Tool Pouch Kit

Includes green tool pouch, hand trowel, hand fork and children's garden gloves. Gloves have a wide cuff and extra fabric over the knuckles to help protect little hands. Glove design may vary

Item #	Desc	UPC	Vendor	CS/UOS	Location
81550787	Pink	501355612463	7-LP463	6/6	National
81550785	Blue	501355612441	7-LP441	6/6	National

Small Hand Tools

These colorful garden tools are perfect for the youngest gardeners ages 3-10! These tools are great for the garden or sandbox. 36 piece Assorted Case pack contains 12 each of square, round, and fork hand tools. 6.25"L



Item #	Desc	UPC	Vendor	CS/UOS	Location
81550823	Square Trowel	692815212856	G340	12/12	National
81550824	Round Trowel	692815212855	G350	12/12	National
81550825	Fork	692815212857	G360	12/12	National
81551163-13080	36-Piece Assorted	017783651039	G330	1/1	National





All planters feature drain holes.



Purse Planter

10" Purse Planter with Rope Handle



Item #	Desc	UPC	Vendor	CS/UOS	Location
80731220	10"	727744803758	FPPRH10	12/12	East

Turtle & Snail Planter

6" Opening, 13" Tall x 9" Wide x 9" Long Resin Planter, 2 assorted styles per case



Item #	Desc	UPC	Vendor	CS/UOS	Location
80731316	6" Planters	727744904141	FTS6	4/4	East



Hedgehog, Owl, & Frog Planters

Hedgehog: 5.75" Planter, 7.5" Wide x 11.5" Long x 6.5" Tall
Owl: 4.25" Planter, 9" Wide x 8" Long x 8.5" Tall
Frog: 5" Planter, 8.5" Wide x 12" Long x 6.5" Tall

Item #	Desc	UPC	Vendor	CS/UOS	Location
80731309	Animal Planter	727744904165	FHOF5	6/6	East

Polka Dot Teacup Planters

Polka Dot Teacup planters assorted colors bring the whimsical tea time experience to your garden or patio with these planters. Great teacher or Mother's Day gift items. All planters feature drain holes.



Item #	Desc	UPC	Vendor	CS/UOS	Location
80730997	5"	727744802751	FPDTC5	12/12	East



Ceramic Insect Mug Planter

Ceramic mug planters with drain holes, come in three styles ladybug, dragonfly, and butterfly.

Item #	Desc	UPC	Vendor	CS/UOS	Location
80730505	5"	727744801082	FCDMI5	12/12	East

Butterfly And Dragonfly Pail Planters

9" Metal Butterfly and Dragonfly planters in assorted colors with drainage holes



Item #	Desc	UPC	Vendor	CS/UOS	Location
80730980	9"	727744802713	FBDP9	12/12	East

KD Watering Can Planter - Galvanized Brush

4 assorted finishes, easy to assemble



Item #	Desc	UPC	Vendor	CS/UOS	Location
80731156	7"	727744803062	KDWC7GB	12/12	East

Bug Watering Can Planter

4 assorted colors, no assembly required!



Item #	Desc	UPC	Vendor	CS/UOS	Location
80731303	4.5"	727744904059	FBWC4	24/24	East



KD Watering Can Planters Polka Dot

10" KD Polka Dot Watering Can Planters. 4 assorted designs, easy to assemble

Item #	Desc	UPC	Vendor	CS/UOS	Location
80731336	10"	727744904028	KDWC10PD	12/12	East



Elephant Watering Can

Stands about 8" tall, 15" long and holds 2 quarts--the perfect size for your window box flowers or house plants.



Item #	Desc	UPC	Vendor	CS/UOS	Location
81320029	Grey	078304631824	63182	12/12	East

Lamb Planter

18" Plastic Blow-Mold Lamb Planter with pink accents. Has a 5" diameter opening.



Item #	Desc	UPC	Vendor	CS/UOS	Location
81320011	18"	078304516909	51690	6/6	East

Pig Planter

18 1/2" Plastic Blow-Mold Pig Planter. Has a 6" diameter opening.



Item #	Desc	UPC	Vendor	CS/UOS	Location
81320091	18 1/2"	078304533609	53360	6/6	East

Cow Planter

18 1/2" Plastic Blow-Mold Cow Planter with black spots. Has a 5" diameter opening.



Item #	Desc	UPC	Vendor	CS/UOS	Location
81320014	18 1/5"	078304533500	53350	6/6	East

Swan Planter

16" Plastic Blow-Mold Swan Planter with a yellow bill. Has a 6 1/2" x 8 1/2" opening.



Item #	Desc	UPC	Vendor	CS/UOS	Location
81320008	8"	078304518200	51820	12/12	East
81320009	11"	078304518309	51830	12/12	East
81320007	16"	078304516800	51680	6/6	East



L'il Buggers

100% cotton. Snug-fitting knit wrist.

Item #	Desc	UPC	Vendor	CS/UOS	Location
82290059	XX-Small	065537071466	6165	12/12	East



Kids Oh, Snap!

15gg WasteNot™ polyester knit made from 23.5% (+/- 2%) recycled post consumer PET bottles. Sandy latex palm coating. Ergonomically formed. Snug-fitting seamless knit wrist.

Item #	Desc	UPC	Vendor	CS/UOS	Location
82290042	XX-Small	065537866277	6171-XXS	60/6	East
82290041	X-Small	065537866284	6171-XS	60/6	East

L'il Monkees

Nylon seamless knit. Rubber crinkle latex coating. Snug-fitting knit wrist.

Item #	Desc	UPC	Vendor	CS/UOS	Location
82290057	X-Small	065537823454	6146	12/12	East

Splish & Splash

6163 Splish & Splash Gloves are the perfect size for your children! At a very small Kids Size XXS these nylon seamless knit gloves have a rubber crinkle latex coating to keep your kids hands safe while they play in the yard with mom and dad. These gloves have a snug fit wrist cuff to prevent dirt and grime from getting into the glove keeping your hands clean.

Item #	Desc	UPC	Vendor	CS/UOS	Location
82290058	X-Small	065537829197	6163	6/6	East



Kids Simply Mud

Latex free to avoid allergic reactions. Form fitting extended cuff keeps glove on and debris out. Breathable lightweight nylon liner to keep your hand cool. Water resistant textured nitrile palm provides excellent grip, wet or dry.



Item #	Desc	UPC	Vendor	CS/UOS	Location
81751129	Huckleberry	616314186011	081H/K	6/6	East
81751130	Kiwi	616314186028	081K/K	6/6	East

Terms and Conditions

UPS / FED EX

We generally recommend UPS / Fed Ex deliveries as the best method for shipping, providing these requirements can be met: all UPS / Fed Ex shipments require a street address and a zip code. Please do not ask us to ship UPS / Fed Ex unless these requirements are met.

Hazardous materials can not be shipped UPS / FEDEX / USPS

There is a \$26.00 charge per package for all C.O.D deliveries by UPS / Fed Ex. We suggest paying by credit card to alleviate this. UPS / Fed Ex has a fuel surcharge into their freight rates that will fluctuate monthly based on current fuel cost. All orders will have a \$15.00 charge for packaging and handling. There is an additional handling fee of \$25.00 for all packages not in a box or 48 inches along it's longest side, and 30 inches along its second longest side, or has an actual weight of 70 pounds or greater. **Any refused C.O.D deliveries will incur a 25% restocking charge.**

UPS / FED Ex- Damaged Shipments

If you see that a shipment is damaged upon receipt from UPS / Fed Ex, refuse shipment. UPS / Fed Ex will return the shipment to us, and we will file the claim and send a new shipment to you. If after opening the package you find concealed damage, call us at once. We will instruct UPS / Fed Ex to pick up the package and return it to us for a claim. We will reship your order.

C.O.D. Shipment

Will be made to all accounts with a balance over 60 days.

Payments

We accept Cash, Check, or the following major Credit Cards: American Express, Visa, MasterCard, and Discover. No additional discounts allowed on credit card payments. Credit cards taken after the initial purchase will require a signed form stating that purchaser agrees to a 2% processing fee, charged by Griffin Greenhouse Supplies, Inc. and will be charged with the balance being paid.

Offerings

Listed are made subject to being available. We will not be held responsible for delays in shipment caused by conditions beyond our control. Applicable substitutes will be made when necessary.

Terms

Are net 30 days unless otherwise stated. A 1½% per month service charge is added on all overdue accounts. This is an 18% annual charge. Terms are COD where credit has not been established. Returned checks will be assessed a \$20.00 fee. Delayed Payment Plan (dating) will only be extended to accounts with a satisfactory payment record.

Direct Shipment Deposits

All material that is shipped Direct from the manufacturer to the customer will require a 30% deposit before the order can be placed with the manufacturer. Depending on the size or complexity of the order you will be required to sign off on a bill of lading to ensure the accuracy and condition of the order.

Returns

No merchandise may be returned without authorization from our office. Merchandise must be returned within 60 days of purchase. Invoice number and date of purchase is required for any/all returns. A restocking charge of 20% is charged on all returns unless merchandise is defective. **ITEMS THAT ARE SPECIAL ORDERED, MADE TO CUSTOMER SPECIFICATIONS, NON-INVENTORY OR NON-STOCK ITEMS, CANNOT BE RETURNED FOR ANY CREDIT DUE TO THEIR SPECIAL NATURE.**

Chemical Shipping

No chemicals will be left without a customer signature. All restricted use products must be accepted and signed for by the license holder only, which is enforced by state law.

Sales Tax

Appropriate state tax will be charged based on location of delivery. All items will be charged sales tax unless we have your tax exempt number on file. In compliance with the law, we must charge the tax on all items, which the state designates as taxable even though you have provided us with your sales tax number. If any items purchased are for company use please notify us so the appropriate tax can be charged.

Recommendations

Made by us are compiled from recognized horticultural sources. We are not responsible for damage or failure due to recommendations given by Griffin Greenhouse Supplies, Inc.

Notice to Purchaser

The following is made in lieu of all warranties expressed or implied. Seller's and manufacturer's only obligation shall be to replace such quantity of the product proved to be defective. Neither seller nor manufacturer shall be liable for any injury, loss or damage, direct or consequential, arising out of the use or the inability to use the product. Before using, user shall determine the suitability of the product for his intended use, and user assumes all risk and liability whatsoever in connection therewith. The foregoing may not be changed except by an agreement signed by officers of seller and manufacturer. All terms and conditions listed are subject to change.

Motor Freight Shipments

In order to provide you with the best service possible all deliveries made must be signed for, which will ensure the right product and quantities are received. All pallets are wrapped with black wrap and taped to ensure your order arrives complete. If your pallet is tampered with, please sign the bill of lading **"1 pallet received, tape and wrap has been broken."** Any shortages or missed shipments must be noted upon receipt of your delivery, so please try to be available on delivery date.

All orders for delivery must be placed 24 hours, or 2 working days, prior to your delivery day.

The original Bill of Lading attached to our invoice indicates that material shipped has now become your property and is an acknowledgment by the transportation company of the receipt of the property in good condition. Safe delivery of this shipment is now the responsibility of the carrier. Please examine your shipment carefully before signing the freight bill. We will be glad to assist in tracing or recovery of lost merchandise.

Motor Freight - Damage or Shortage

If any damage is noted, or if the number of pieces received does not agree with the number on the bill of lading, **DO NOT** accept the shipment without shortage or damage notated on your freight bill and signed by the carrier's agent (driver). Failure to do so may jeopardize your recovery. If any concealed damage or shortage is discovered when unpacking, leave the material and the packing as is and notify the carrier for a concealed damage or shortage inspection. Consult the carrier for the necessary claim papers and disposition of damaged articles. When checking shipments, compare what was received with packing list or invoice. If there is a shortage or damage, **YOU MUST CONTACT US WITHIN 24 to 48 HOURS** and provide us with full details and pictures.

Claims with motor freight companies must be made promptly. The freight company will not consider a claim unless it is presented within nine months from the date of shipment. The carriers agent will assist you in making that claim. Claims for loss or damaged material and transportation charges **MUST NOT** be deducted from the invoice and the payment of invoices **MUST NOT** be withheld awaiting adjustment of such claims, since it is the function of the carrier to guarantee safe delivery.

PRICES AND TERMS ARE SUBJECT TO CHANGE WITHOUT NOTICE.

Prices at time of shipment will prevail. For current quotations, please call us. Prices quoted are FOB Denver, CO; Cheshire, CT; Ball Ground, GA; Tewksbury, MA; Gray, ME; Bridgeton, NJ; Auburn, NY; Brookhaven, NY; Schenectady, NY; Salem, OR; Morgantown, PA; Richmond, VA; and Woodridge, IL. or FOB the factory unless otherwise stated.

A

- 3-1 Garden Spray 204, 206, 214, 215
- 3-Tube Sprinkler Hose..... 114
- A & G Agricultural Supply 243-243
- Acacia Wood Collection 339
- Acid Loving Plants Mix 37
- Acid Special Fertilizer 37, 39, 42, 137, 140, 144, 149, 151, 160
- Adjustable Nozzles 110, 111, 117, 118, 126, 129
- Advanced Mix #4 26
- African Violet Food 14, 15, 26, 150, 159
- African Violet Soil 41, 43, 46
- Agrosun Dayspot Bulb 19,
- Air Planters 263, 314
- Alabaster Blend Stone..... 47
- Alena Collection..... 284
- Alfalfa Meal..... 139, 142
- Alice Planter 317
- All Natural Plant Food 135-151, 158
- All Natural Plant Hangers 312-314
- All Purpose Plant Food. 135, 136, 137, 141-163, 165-168
- All Purpose Potting Soil/Mix .. 36, 38, 42, 44-46, 48-50, 54-56
- All Season Lawn Food 68,
- All Seasons Spray Oil 206, 225
- All Weather Hose..... 114, 116, 130
- Allaire Tall Planter 283
- Aluminum Hand Tools 84
- Aluminum Hose Hanger 115
- Aluminum Shut Off Valve 115, 119, 121
- Aluminum Sulphate 35, 48, 153
- Aluminum Water Breaker Nozzle 110
- Amer Deer Proofing (Everguard)..... 219
- American Garden Works 172, 173
- American Lawn Mower 81
- Amturf..... 63
- Ana Planter 317
- Anchoring Pins 248
- Angled Planter 304
- Animal Planters 275-277, 281, 324, 326, 334
- Animal Repellents 209, 210, 211
- Animal Trap 225, 226
- Annual Bloom Flower Garden Pansy Fertilizer. 141
- Annual Grub Beater..... 64
- Annual Tree & Shrub 205,
- Ant Bait 207, 237
- Ant Control 206, 207, 216, 228
- Ant Flea and Tick Granules 207
- Ant, Roach, Spider Control .. 207, 208, 216, 228
- Anti Transpirant 167
- Antique Kettle 308, 326
- Antiqued Stone Faced Planter..... 334
- Anvil Lopper 87
- Anvil Pruner 83
- Arber..... 135, 201
- Arber Bio..... 201
- Arber Plant Food 135
- Arber Spray Bottle 201
- Arc Bowl Planter 287
- Arcadia 171, 172, 245, 262-263
- Ariana Planter 265
- Artichoke Cement Planter..... 277
- Artie Planter 278
- Ashton Manor Planter 286
- Aspen Planter 298
- Assorted Stone 40, 47, 51
- Atlas..... 201
- Aurora Innovations 18
- Aurora Roots Soil 18
- Auto Mix Hose End Sprayer 106, 107
- Avino Square Planter..... 298
- Azalea Fertilizer..... 140, 144, 151
- Azalea Pot 294
- Azalea-tone 144
- Azomite Powder 139
- Aztec Strawberry Jar 326
- Azura Series 289

B

- Backpack Sprayer 96, 100, 101, 107
- Balcony Window Box... 268, 279, 284, 290, 297, 307, 315, 336
- Bamboo Gloves 174, 197
- Bamboo Self Watering Planter 290
- Bamboo Stakes 255- 257
- Bamboo Teepee Trellis 257
- Bamboo Torches 177, 193
- Bar Harbor Blend 36
- Barrel Planter 284, 287, 296, 319, 331
- Barrier Netting, Deer 246
- Basket Hanger 287
- Basket Planters 263, 269, 272, 292-293, 309, 311, 315, 320-322, 336
- Bat Guano 139
- Bat House/Shelter 348, 352
- Bat Magic 210
- Bat Repellent 210
- Battery Powered Sprayer 96, 100
- Bear Planter..... 275
- Beastie Bloomz 148
- Bed Bug 209, 213
- Beetle Bagger Trap..... 212, 236
- Beetle Control 205, 206, 220
- Bellina Planter 283
- Bembe Nutrients..... 149
- Benchmaster/SPC Retail..... 60

- Berry-tone 145
 Better-Gro/Dynamite 13, 135
 Big Bloom 150
 BioAdvanced 213-217
 Bio-tone Starter 146
 Birch Planter 281
 Bird & Pond Netting 249
 Bird Bath Cleaner 238
 Bird Bath Fountain Maintenance 238
 Bird Baths 339, 350, 351, 355
 Bird Feeders 339, 344-353,
 Bird Food 340-342, 355-358
 Bird Houses 346, 348, 352
 Bird Seed 340-342, 355-358
 BirdBlock Mesh 249
 Biting Insect Repellent 236
 Black Beauty Grass Seed 74, 75
 Black Cauldron Planter 326
 Black Gold 26, 55
 Black Sand 51
 Blackboard Label 31
 Bloem 105-106, 177, 264-268
 Blood Meal 139, 142, 146, 153, 154
 Bloom Nutrient 143, 167
 Bloom! 1-3-1 147
 Blossom Booster 162, 166
 Bluebird House 346, 348
 Boho Pot 269
 Bone Meal ... 138, 139, 142, 146, 149, 154, 159
 Bonide 14, 106, 135, 201-213
 Bon-Neem 208
 Bonsai Mix/Soil 41, 48, 154
 Bonsai Shears 18,
 Bontone 14
 Boomerang 149
 Boost 20, 167
 Border Cylinder, Clay 294
 Bosmere 13, 81, 176, 177, 246
 Boss Glove (Westchester) 197, 198
 Bow Rake 82, 90
 Bowl Planter .263-264, 267, 270, 282, 284-287,
 298-299, 304-306
 Brass Hose Swivel 110
 Brass Nozzle 110, 118
 Brass Quick Connectors 120
 Brass Shut Off Valve 115, 120, 121, 127
 Braun 106, 268-273
 Breaker Nozzles 110
 Brentwood Planter 317
 Broadleaf Weed Control 201, 203, 223, 224,
 232, 233,
 Brome 339
 Bromeliad Food 13, 156
 Broom 89
 Brush Killer 202, 215, 219, 233
 BT 205, 224, 223
 Bug & Slug Killer 205
 Bug Buster 223, 230
 Bug Mugs Planter 333
 Bugs For Birds 349
 Bulb Food 144
 Bulb Pan 264, 294
 Bulbs, Grow Light 19,
 Bulb-tone 144
 Bulk Coco Liner 310, 335
 Bulk Hardwood Stakes 256, 257
 Bulk Landscape Fabric Pins 248
 Bulk Moss 57-58
 Bulk Peat Pellets 21,
 Bulk Spikes 161
 Bulk Steel Stakes 256, 257
 Burlap 249, 251
 Bush Doctor 149
 Bust Planter 272
 Butterfly Feeder 344
 Butterfly Plant Stakes 182, 189
 Bypass Pruner 83, 92, 95, 97
- ## C
- Cache Pots 271, 305
 Cactus Food 14, 15, 26, 135, 137, 143, 150, 154
 Cactus Mix/Soil 37, 38, 41, 43, 46, 50, 54, 55
 Cado-Union 131, 326, 355
 Cage, Suet 344, 347
 Cages, Tomato 258
 Cakes, Suet 340, 343, 344
 Calcium Supplement ... 152, 154, 162, 165, 231
 Candle Lanterns 193
 Cape Cod Challenger 135
 Capello Planter 282
 Capri Bowl 299
 Captain Jack Deadweed Brew 202, 203,
 Captain Jack Lawnweed Brew 202
 Captain Jack's Deadbug Brew 206
 Caribbean Pot 298
 Carpenter Ant Control 209, 216
 Carpenter Bee Killer 216,
 Carpet Saver Saucer 274-275
 Cast Iron Plant Caddy 290
 Castine Blend Raised Bed 36
 Cat Repellent 209, 218, 227
 Caterpillar Killer 205, 206, 224
 Ceiling Hook 190, 313
 Cement Buddies 276
 Cement Heart Planter 279
 Cement Pots 275-280

Cemetery Vase Planters	308	Cobstock Blend Garden Soil	36	Corinthian Planter	282
Ceramic Planters ...263, 269-271, 275, 278-279		Coco Fiber Liner ...263, 292-293, 310, 333, 336		Cork Mat Saucer.....	275
Ceramic Tea Cup Planter	333	Coco Loco Potting Mix.....	46	Cork Saucer.....	275
Cha Ching	148	Coco Moss Liners..263, 292-293, 310, 333, 336		Corn Gluten	168
Chandler Planter	288	Coco Moss Planters 263, 292-293, 310, 333, 336		Corner Plant Stand.....	178
Chapin	66,	Cocoa Shell Mulch.....	44	Corona.....	82-94
Charcoal	41, 43, 48, 50	Coconut Coir	18, 23, 24, 25	Cottonseed Meal	153
Chemically Resistant Sprayer	101, 107	Coffee Cup	279, 322	Countryside Planter	306
Chicken Manure	147, 158	Coir Blocks/Bricks	18, 23	Cow Manure	47, 56, 147
Chickweed Killer	202,	Coir, Bagged	18	Cow Planter	275, 310, 326,
Chipmunk Repellent	211	Colander Planter.....	333	Crab Meal.....	139
Christmas Ornament Planter	281	Colchester Planter	278	Crab Shell	166
Christmas Tree Watering Aid.....	179	Coles	340-342	Crabgrass & Weed Killer	201
Citronella Candles	192, 193	Colorado Beetle Killer	206	Crabgrass & Weed Preventer	201
Citronella Oil	193	Combo Pruning Set.....	98, 100	Crabgrass Control	201
Citrus FeED.....	160	Compact Pruners	83, 84, 95	Cracked Corn	340
Citrus Fertilizer 137, 141, 149, 155, 157, 160, 162		Compact Shears.....	95	Crawling Insect Control204-207, 216, 221, 224, 240	
Citrus Food .. 137, 141, 149, 155, 157, 160, 162		Complete Disease Control ...204, 206, 212-215, 218, 220, 232		Cultivation Nation Fertilizers.....	147
Citrus Leafminer Trap.....	235	Complete Grow Light Systems	24, 29, 30	Cultivation Nation Growing Mix	45
Citrus-tone	144	Compost Blend	35, 56	Cultivator	85, 87
Clark's.....	185, 250	Compost Starter	142, 147	Cultivator, Hand	84, 98
Classic Home & Garden ..178, 179, 275-288, 340		Compost Tea Bags	168	Curio Planter	
Classic Urn	306	Compost Thermometer.....	163	Curtis Wagner	274-275
ClassiCote Fertilizer	160	Composted Cow Manure	37, 147	Cushion Grip Tools	84-87
Clay	293-294, 317	Compound Action Tree Pruner	85		
Clay Pebbles	18,	Cone Planter	269, 309, 320,	D	
Clear Dome	19, 21, 24, 30	Connecting Stakes	253	Dakota Trough	280
Clear Saucers (Vinyl)	274-275	Container Mix/Soil 36, 38, 42, 44-46, 48-50, 54-56		Dalen	179, 246, 247
Cleopatra Bust.....	272	Contractor Hose	130	Dark Harbor Blend Org. Mulch	37
Clinch Couplers.....	127	Coop Poop	158	Dayton Planter.....	264
Clonex	16,	Copper Fungicide	212, 213, 225, 232	DCN	288-290
Clover Control	202	Copper Plant Label	23	Deck Railing Bracket.....	190, 289
Coast of Maine	15, 35-37, 136	Copper Stoper Slug Snail Tape	227	Deck Railing Planters .. 268, 279, 284, 290, 297, 307, 315, 336	
Coated Paper Tree Wrap.....	250				

- Deco Faceted Bowl 304
- Decorated Pumpkin 194, 297
- Decorative Glass Gems 39, 52
- Decorative Moss Baskets 269, 272, 320-322
- Decorative Plant Stakes 182-185, 189
- Decorative Sand 40, 47, 190
- Decorative Stones 39, 40, 47, 51, 52, 58
- Decorative Trellis 171-173, 176
- Decorative Watering Cans.... 105-106, 114, 124, 125, 128, 129, 132
- Deep Saucers 274
- Deer Ban 239
- Deer Netting 246
- Deer Park Ironworks 179-181
- Deer Repellent..... 211, 218, 227
- Deer Scram 218
- Dehydrated Cow Manure..... 47, 147
- Deluxe Pedestal Urn..... 264
- Dense Shade Grass Seed..... 75
- Deroma 293-295
- Desert Sand 47, 51
- Devault 296
- Devoncourt Planter..... 288
- Dew Right Water Bag 181
- Dewitt 181, 248, 249
- Dial Nozzles..... 111, 118, 129
- Diatomaceous Earth 207, 208, 218, 221, 225
- Digging Bar..... 93
- Digging Fork 85, 89
- Digital Heat Mat Controller 17
- Digital Moisture Meter 163
- Dipel Dust..... 221
- Dirt Pot..... 17
- Disease Control... 201, 203, 204, 206, 208, 212, 213, 215, 218, 220, 225, 230
- Disease Control, Lawns..... 218, 225
- Disease Control, Nat & Organ..... 201, 217, 225
- Disease Control, Roses 201, 204, 218
- Disease Control, Roses 204, 205, 206
- Dish Garden . 264, 268, 285, 271, 294, 304-306
- Distinction Planters 289
- Distressed Oak Keg Planter 284
- Dog Repellent 209, 218, 227
- Doherty Pots..... 284
- Dome 17, 19, 24,
- Don't Bug Me Insect Spray 148
- Dotted Ceramix Planters 278
- Double Drawer Planter 273
- Double Peony Ring..... 253, 258
- Double Thick 1020 Tray..... 29
- Down to Earth..... 136-140
- Down Under Plant Caddie..... 176, 177
- Dr. Earth 38, 39, 21, 140-143, 218
- Dr. Iron 234
- Dragonfly Pot..... 335
- Drain Spade 90
- Dramm 95, 108-115
- Dried Blood..... 139, 142, 146, 153, 154, 159
- Dried Mealworms 342, 355
- Duck Planter 275
- Dura Cotta Planter..... 266
- Dust, Disease Control 205, 213
- Dust, Insect Control..... 205, 212, 213, 224
- Dutch Kettle Planter 308, 326
- Dynamite/Better Gro 13, 35, 135
- E**
- Earthbox 308-309
- Earthworm Castings 36, 41, 55, 158
- Easel Stand 192
- Eaton 185, 250, 251
- Eclipse Planter..... 298
- Eco Pond Clear 157
- Edgemaster 86
- Edger 86
- Edging 249
- Eight 14, 205-207
- Electronic Mister 127
- Electronic Soil Tester 164
- Electronic Timer 107, 122
- Elephant Watering Can 131
- Ella Planters 305-306
- Elle Planter 282
- English Bowl 270
- Epic..... 218
- Epsom Salts 232
- Espoma 15, 41, 42, 144-147
- Essential Vase 324
- Evergreen Spikes 161
- Evergreen Tone 145
- Everguard 219
- Exhart 182 -185
- Exotic Pebbles..... 39, 40
- Extendable Handle Tools..... 85
- Extended Control Weed Preventer 77
- Extended Feed Fertilizer 68, 77
- Extender Chain..... 192
- Extender Hook 187, 188, 190-192
- F**
- Fabric Pegs/Pins/Staples 248
- Fabric Planters 26
- Face of the Forest Planter 171
- Fafard 56
- Fairy Garden Kit 171
- Fall Fertilizer 68, 76

- Falmouth Planter 279
- Fan Spray Nozzle 112
- Fan Trellis 243
- Fast Grow Grass Seed Mixture 76
- Faucet Adapter 118
- Feather Meal 138
- FeED 19,
- Felco 96, 97
- Fertilizer Plus Weed Control 65, 66, 77, 168
- Fertilizer Spikes 22, 161
- Fertilizer, Iron 135, 152, 157, 162, 234
- Fertilizer, Lawn 68, 73, 77, 141
- Fertilome 16, 43, 44, 150-152, 219-222
- Fibered Sphagnum Moss 52
- Fiberglass Handled Tools 86, 94
- Fiberglass Stake 256, 257
- Filter Washers 122
- Finch Feeders 355
- Finger Snips 84
- Finisher 167
- Finley planter 265
- Fir Bark 48
- Fire ant 223
- Fire Hose Nozzle 118
- Fish & Guano Fertilizer 231
- Fish Bone Meal 136, 138, 142
- Fish Fertilizer 136, 137, 152, 162, 231
- Fish Watering Can 128
- Fish-Seaweed Blend 165
- Flag Pole 186
- Flags 186, 314
- Flaming Squirrel Seed Sauce 340
- Flamingos 194
- Flat Hose 116, 126, 130, 177,
- Flea Control 207, 209, 213
- Flex Garden & Storage Set 315
- Flo Master 96
- Flora Trio Planter 279
- Floral Clipper 84, 88
- Floral Pruner 84,
- Floral Shears 84, 95, 98
- Flower Booster 135, 138, 141-144, 147-151, 155, 156, 162
- Flower Box Liners 307
- Flower Cart 180
- Flower Support/Prop 246, 253-255, 258-260
- Flowering Plant Food Spikes 161
- Flowers & Veggie Fertilizer 135
- Flowers Kiss Plant Food 149
- Flower-tone 144
- Fly Control 212, 237, 238
- Fly Trap 212, 237, 238
- Flying Insect Control 212, 237, 238
- Folding Kneeler Seat 176
- Folding Saw 82, 93
- Foremost Tarp 96
- Forest Bark 48, 51
- Forest Moss 57
- Forged Garden Hooks.. 172, 180, 187, 188, 191
- Formula 707 Soil 18
- Fountain Clarifier & Algaecide 238
- Fountains 178
- Fox Farm 16, 45, 46, 147-150
- French Watering Can 106
- Frey Group 35
- Frost Blanket 246, 249
- Frosty the snowman planter 281
- Fruit & Nut Orchard Spray 203,
- Fruit & Veggie Disease Control.. 206, 214
- Fruit & Veggie Insect Control 203, 205, 206, 214, 220, 221, 224
- Fruit Feeder 344
- Fruit Fertilizer 138, 141, 149
- Fruit Fly Trap 237
- Fruit Picker 93
- Fruit Tree & Plant Guard 203, 204
- Fruit Tree Spikes 161
- Fruit Tree Spray 203, 204, 230
- Fundy Blend Organic Mulch 35
- Fungicide 201, 203, 204, 208, 213, 218, 221, 223
- Fungonil 213
- Fungus Control, Lawns 64, 66, 69, 76
- Futura Planter 289-290

G

- Galvanized Planters 268-271, 273, 281, 291, 310-311, 327-333
- Galvanized Watering Cans 106, 129, 132
- Garden Bowl... 263, 265, 267-268, 282, 284-286, 298, 306
- Garden Compost 42, 56
- Garden Dust 205
- Garden Food 141, 144, 146, 150-152, 158
- Garden Fork 85, 89
- Garden Fountains 178
- Garden Fungicide 203, 208, 212, 213
- Garden Gypsum 42, 46, 138, 152
- Garden Hook 172, 180, 187, 188, 191
- Garden Insect Spray 203-208, 213, 214, 220, 224, 229, 231
- Garden Kneeler 176
- Garden Lime 35, 39, 42, 47, 138, 154
- Garden Manure Blend 47, 56
- Garden Mix/Soil 42, 45, 46, 49, 54, 56
- Garden Molasses 154
- Garden Netting 246, 249, 256
- Garden Pail 132, 268, 329-332

Garden Soil/Mix.....	42, 45, 46, 49, 54, 56	Grass Seed, West	74, 75	H	
Garden Spade	86	Grass Shear	88	Half Bucket Planter.....	310
Garden Statue	184	Grassy Weed Control	202, 228, 233	Hand Leaf Grabs	81
Garden Twine	246, 250-253	Grecian Pedestal Urn	319	Hand Seeder	66, 73
Garden Weed Preventer.....	202, 236	Grecian Urn	319	Hand Sprayer	100, 101, 127
Garden Wire	252	Green Grower Pot	189	Hand Spreader	66, 73
Garden-tone	145	Greenhouse Dome	21,	Hand Tools.....	84, 98
Gardman	44	Greenhouse Grower Kit	21, 25, 31	Hang Loose Planter.....	322
Garman Commodities.....	44	Greenhouse, Mini	17, 19, 31	Hanger (Rod).....	172, 180, 187, 188, 191
Gathering Rings	253	GreenView.....	158	Hanging Animals Plant Pals	324
Geolite	18,	Greenwich Urn	283	Hanging Basket Chain	192
Geometric Ceramix Planters	278	Grid Support Ring.....	176	Hanging Basket Drip Pan	274
Germination Blanket.....	63, 67, 73	Gro Triangle	260	Hanging Basket Fertilizer Spikes	22
Germination Station	17,	Gro-Dome	21,	Hanging Basket Water Wand	107, 112
Gilmour	115-124	Ground Bee Killer	208	Hanging Baskets	172, 263, 269, 272, 282, 286, 288, 292-293, 305, 309, 316, 320, 327-328, 333, 336
Glass Bird Baths	351	Ground Force	202,	Hanging Bowl	305
Glass Gems	39, 52	Ground Hog Repellent	201, 227	Hanging Solar Lights	198
Glass Miniatures.....	323	Grow Bags.....	17, 26, 27, 177	Hanging Terrarium	314
Glass Plant Mister	131	Grow Big	16, 18, 150	Happy Frog	45, 148, 149
Glass Terrarium	314, 323	Grow Bulbs	19	Hardwood Stakes	256, 257
Gloves	173-175, 194, 196, 197	Grow More.....	154-158	Harmony Planters	289-290
Glyphosate	202, 222 232	Grow Pole	245, 254, 259	Harvest Guard	179
Gnome Statues.....	185	Grow Through Grids	253	Haverhill Planter	285
Gnome Watering Cans	128	Grow!T Coco Coir	18	HC Companies	124-125, 297-304
Go Away Repellent	209, 211	Growers Basics Pot.....	297-298	HDI	16,
Gonzo.....	225-227	Growers Blend	18,	HDR Wine Barrel	319
Good Earth (Hoffman)	17, 159	Growers Mix	15	Head Planters	271-272, 334
Gopher Getter Nidget	230	Growing Lights	18, 19, 29, 30	Healthy Grow	158
Gopher Killer	209, 210, 240	Grub Beater.....	64	Heat Mat.....	17
Gopher Shield	227	Grub Control	64, 65, 71, 76, 78	Heat Mat Controller	17
Gopher Trap	226, 227	Grub Control	64, 65	Heath.....	186, 343-345
Grafting Wax	185	Gypsum	42, 46, 138, 152	Heavy Traffic Grass Seed	75
Grass Fast Natural Roll	67, 73			Hedge Shears	87, 91
Grass Killer	202, 233			Herb Carrier.....	311
Grass Seed	74-76, 78				

- Herb Planter 26, 189, 310-311
- Herbicide Granules..... 223
- Hi-Flo 4 Way Hose Valve..... 121, 122, 126
- High Caliper Growing (Smart Pot) 26, 27
- High Rise Sprinkler 123, 124, 125
- Hi-Yield 152-154, 220-224
- Hobby Greenhouse 31
- Hoe 85, 89, 94
- Hoffman-Good Earth 17, 47, 48, 159
- Holiday Star Window Box 281
- Holly-Tone..... 144
- Holographic Scare Tape 179
- Holster, Pruner 88, 97
- Home Insect Control 213, 216, 222
- Honeycomb Planter 271
- Honeysuckle Planter 283
- Hookery 187, 188
- Hooks/Hangers..... 313
- Hori Hori Garden Knife 87
- Hornet Killer 204
- Horticultural Charcoal 41, 43, 48, 50
- Horticultural Lime 35, 42, 47, 138, 154
- Horticultural Oil 206, 225, 230, 239
- Hose 114, 116, 130
- Hose Connector 120, 126
- Hose End Sprayer 106, 221
- Hose Guide 110, 124
- Hose Hanger 115, 129
- Hose Menders 119, 127
- Hose Washers 110, 122, 127
- Hose, Soaker 115, 116, 126, 130
- Hot Meats 340, 341
- Hot Pepper Wax (Repellent) 211
- House, Bat 348, 352
- House, Bird 346, 348, 352
- Household Insect Control 14, 20, 213, 214, 216, 218
- Houseplant Food 13, 14, 135, 159
- Houseplant Food Spikes 22
- Houseplant Insect Control 14, 201, 206-208, 213, 214, 228
- Houseplant Special..... 159
- Hula-Ho Weeder..... 81
- Humic Acid, Granular..... 139
- Humidity Dome 21
- Hummer's Galore 345
- Hummingbird Feeders . 343, 345, 347, 349-351,
- Hummingbird Nectar 345, 354
- Hydrangea Blue..... 155, 160
- Hydrangea Food 136, 155, 160
- Hydrated Lime 35, 154
- Hydro FeED..... 19
- Hydro Trio Pack 148
- Hydrofarm..... 17, 18, 19,
- Hydrolyzed Fish..... 165
- Hydroponic Calcium Nitrate 20,
- Hydroponic Clippers 15, 19,
- Hydroponic Micro Snip 15, 19
- Hydroponic Nutrients 16, 148
- Hydroponic Scissors 83, 84
- Hydroponic Soil 18
- I**
- Impulse Sprinkler 113, 115, 123, 125, 126
- In Pot Cane Support 260
- Indoor Insect Killer 14, 201, 209, 213, 222
- Indoor Light Systems 18, 24, 29, 30
- Indoor Plant Food 14, 15, 26, 135, 156, 231
- Indoor Watering Can ... 114, 124, 125, 128, 129, 131, 132
- Infuse 64, 212
- Insect & Grub Control 64, 65, 71, 76, 78
- Insect Control 14, 201, 228, 229
- Insect Control Dust..... 205,
- Insect Control Granules..... 14, 204-207
- Insect Control, Lawns 228
- Insect Control, Organic 14, 205, 207, 208
- Insect Repellent..... 69-71
- Insecticidal Soap 14, 208, 229
- Instant Green Mat 58
- Iron Supplement .. 135, 152, 157, 162, 165, 234
- Iron-tone 145
- J**
- Jack O'Lantern Pot 297
- Jack's Classic 159-161
- Jack's Nutrients 19, 20, 159-161
- Jackson Pottery 261, 304
- Jagger Shell Planter 277
- Jake Planter..... 280
- Jameson Rail Planter 284
- Japanese Beetle Killer 205, 206, 220, 237
- Japanese Beetle Trap 212
- Jiffy 21, 22
- Jiffy-Pots 21, 25
- Jobe's 22, 161
- Jonathan Green 73-78
- JRM Chemical 21, 25
- Jumbo Ceiling Hook 190
- Jumbo Fly Catchers 212
- Jump Start Light 18
- Junior Garden Kit, Earthbox 308-309
- Jute Twine 250-252

- K**
- Kaleidoscope Planter 304
 - Kangaroots 21, 112, 149
 - Kay Planter 319
 - Kelp Me Kelp You 149
 - Kelp Meal 136, 140, 142, 146, 166
 - Kiawah Planter 278
 - Kid's Gloves 175, 195
 - Kids Tools 102
 - Killzall 221
 - King Cup Planter 269
 - Kleen Up 201, 202
 - Kneeling Pads 176
 - Knox Fertilizer (Schultz) 26, 168
 - Ko Ko Bop Coconut Coir 46
 - Koekedama Sphagnum Basket 58, 322
- L**
- Labels 23, 31
 - Lacis Trellis Planter 320
 - Ladder Trellis 176
 - Lamb Planter 326
 - Lambert 22, 49, 50
 - Land & Sea Compost 42
 - Landscape Fabric 248, 249
 - Landscape Rake 82
 - Langbeinite 140
 - Lantern Planter 310
 - Lanterns 21, 130, 143
 - Large Mouth Fish Planter 277
 - Lava Rock 47
 - Lavendar Garden Planter 268
 - Lawn Booster 64
 - Lawn Disease Control 64, 66, 69, 76, 213, 215, 216, 218
 - Lawn Edging 249
 - Lawn Food 68, 73, 77, 141
 - Lawn Food, Natural 73, 77, 141
 - Lawn Fungicide 203, 223
 - Lawn Insect Control 228
 - Lawn Moss Control 64, 65, 76
 - Lawn Repair 63, 73
 - Lawn Restore 68,
 - Lawn Seed Starter 68, 73, 77, 234
 - Lawn Soil 76, 77
 - Lawn Weed Killer 168, 202, 233, 235
 - Leaf Compost 35
 - Leaf Rake 81, 82, 90
 - Leaf Scoop 94
 - Leaf Shine 14, 26
 - Leather Holster 88, 97
 - Lebanon 73
 - LED Light 24
 - Legacy Urn 283
 - Level Head Rake 82
 - License Plate Planters 280
 - Light Kits 18, 19, 24, 29, 30
 - Light Meter 164
 - Light Warrior Potting Soil 46
 - Lighted Pumpkin 194
 - Lightning Lime 67
 - Lime 35, 39, 42, 47, 138, 154
 - Link-ups 253
 - Liquid Copper Fungicide 213, 230
 - Liquid Iron Complex 135
 - Liquid Kelp 149, 158
 - Liquid Plant Food 14, 15, 16, 26, 135
 - Liquid Plant Shine 14, 26
 - Liquid Squid Food 136
 - Liquinox 162-163
 - Lobster Compost 36
 - Lobster Meal 136
 - Loop Stakes 253, 258
 - Loppers 87, 91
 - Lucky Bamboo 154
 - Lucky Duck Watering Can 128
 - Luster Leaf 23, 189, 163, 164, 252, 253
- M**
- Machete 92
 - Macrame 21, 249, 312-315
 - Mag-I-Cal Calcium Fertilizer 77
 - Magnesium Sulfate 153, 232
 - Malathion 206, 207, 222
 - Mancozeb 212
 - Manure 47, 56, 147, 158
 - Marine Cuisine 148
 - Mark It Blue 235
 - Mason Jar Candles 192
 - Mater Magic 135
 - Mathers planter 266
 - Mattock 93
 - Maxwell Planter 277
 - Measuring Cup 221
 - Mechanical Water Timer 107, 108, 122, 126
 - Melnor 125-127
 - Messinas 227, 228
 - Metal Planters 268-271, 273, 281, 291, 310-311, 327-333
 - Metal Watering Cans 106, 129, 132
 - Microbe Plant Food 149
 - Micro-Pruner 15
 - Midwest Air 255, 256
 - Milk Can Planters 310
 - Milky Spore 78, 240

- Milorgonite 73
- Mini Greenhouse (4 Tier & 5 Tier) 31
- Mini Greenhouse Kit T5HO 29, 30
- Mini Planter Pot 269-272, 275-278, 282, 299, 304-306, 316, 323-324, 334
- Mini Sphagnum Bale 52
- Mini Tester 163
- Miramonte Basket Set 321
- Mister 127, 131, 201
- Mite Control ... 13, 206, 213, 215, 217, 228, 229
- Mite-X 13, 206
- Modular Light System 30
- Mohegan Blend Black Earth 37
- Moisture Control Potting Mix 41, 49,
- Moisture Meter 163, 164
- Moisture Storing Crystals 28
- Moka Terra Cotta 293
- Mole Control 209, 210, 219, 227
- Mole Killer 209, 210
- Mole Max 210
- Mole Max Sonic Spike 210, 226
- Mole Scram 218
- Mole Trap 226
- Moletox 209
- Monterey 165, 228-235
- Moose Planter 275
- Moroccan Bowl 284
- Mosquito Beater 204
- Mosquito Bits 204, 219, 239
- Mosquito Control 204, 208, 219
- Mosquito Dunks 204, 239
- Mosquito Repellent 193, 204, 219, 228
- Moss 52, 53, 57-59
- Moss Bird Houses 322, 353
- Moss Control 64
- Moss Max 64
- Moss Planters 269, 272-273, 320-322
- Moss Pole 245, 254, 255, 259
- Moss Purse Set 321
- Moss Teddy Bear 273
- Moss, Sheet 52, 57
- Mosser Lee 24, 51, 52, 255
- Mossify 24, 53, 127, 254
- Moth Trap 212, 235
- Motion Sensor Light 198
- Mount Desert Island Cactus Mix 37
- Mouse Magic 210
- Mouse Trap 226
- Mulches 35
- Multi-Function Sharpener 88
- Mushroom Compost 35, 42
- N**
- Nano Dome 30
- Nantucket Planter 285
- Nassau Round Caged Pot 286
- National Audubon 350, 351
- Natural Burlap 249, 251
- Natural Jute Twine 250
- Natural Plant Hangers 312-315
- Nature's Source 165
- Nature's Way 346-350
- Nectar 345, 354
- Neeleze Kneeler 176
- Neem 203, 208, 217, 225, 231
- Neem Seed Meal 139
- Nematode Control 230
- Neptune's Harvest 165-166
- Netting 246, 249
- Never Dry Plant Pal 131, 323
- Nitrile Coated Gloves 173, 194
- NoDampOff Seed Starter 24,
- Novelty 128, 305-309
- Nozzles, Watering 110, 111, 117, 118, 126, 129
- Nursery Container, Black 297
- Nutgrass Killer 202,
- Nyjer Seed 341, 356
- O**
- Oak and Birch Planters 281
- Obelisk 172, 260
- Ocean Forest Potting Soil 45
- Old Farmer's Almanac 186
- Old Farmer's Garden Calendar 186
- Olympia Black Urn 297
- One Touch Water Nozzle 111, 112
- Open Sesame 148
- Orbit 129, 177, 256, 257
- Orchid Bark 35, 57
- Orchid Bloom Booster 13, 161
- Orchid Food 13, 15, 150, 156, 159, 161, 168
- Orchid Liquid 15, 150, 161
- Orchid Mix/Soil 35, 41, 43, 46
- Orchid Moss 35, 58
- Orchid Pot 294
- Organic Insect Control 14
- Organic Plant Food 135-147, 158, 168
- Organic Potting Mix/Soil 15, 18,
- Organic Raised Bed Mix 36, 42, 44
- Organic Seed Starter 15, 25
- Organic Time Release Plant Foods 153
- Organic Weed Control 168
- Original Potting Soil 18,
- Oriole Feeder 344
- Orion Self-Watering Planter 299

- Oscillating Hoe 94
- Oscillating Sprinkler 114, 123-125
- Outdoor Fertilizer Spikes 22, 161
- Oval Planter 195, 268, 281, 287, 291, 296, 298, 311, 327-332, 334
- Oval Tub 311, 329, 331-332, 335
- Owl Horned 179, 247
- Owl Inflatable..... 179
- Oxalis Control 202,
- Oyster shell..... 138
- P**
- Packaged Bamboo Stakes 256
- Packaged Hardwood Stakes 257
- Pallet Assortments 295, 304, 315, 317-320, 335
- Palm Food 141, 155, 157, 160
- Palm-tone 21, 25, 145
- Panacea 129, 189, 190, 258, 259, 309-311, 350-352
- Panterra Oval Pot..... 298
- Paper Tree Wrap 250
- Pasture Fertilizer 234
- Patio Essentials 192, 193
- Pattern Nozzles 108, 111, 117, 118, 126, 129
- Pattern Oscillating Sprinkler 114, 124
- Pattern Rain Wand 108, 112
- Peace Sign Planter..... 322
- Peach Tree Borer Trap 235
- Peanuts 341, 355
- Peat Moss 41, 43, 44, 47, 54-57
- Peat Pellets 20, 21
- Peat Pots 21,
- Pedestal Urn 264
- Penobscot Blend Planting Mix..... 36
- Pentra Bark..... 235
- Peony Support Rings..... 176
- Perlite 41, 43, 48, 50
- Petunia FeED 160
- PH Meter 21, 117, 163, 164
- PH Tester 21, 117, 163, 164
- Pig Planter..... 276, 310, 326
- Pink Flamingos 177, 194
- Pistol Grip Nozzles 111, 117, 118, 126, 129
- Pixie Succulent Planter..... 304
- Plant best..... 24, 25
- Plant Caddy..... 177, 296
- Plant Dolly 296
- Plant Food, Extended Release.... 153, 160, 166, 168
- Plant Hook ... 171, 172, 180, 187, 188, 190-192, 313
- Plant Label 23, 31
- Plant Mister..... 127, 131, 201
- Plant Pal 99, 323-324
- Plant Pot Ring..... 188
- Plant Prod MJ 167
- Plant Props 253
- Plant Shine 14,
- Plant Spikes 22, 161
- Plant Stands 172, 173, 178, 181, 255,
- Plant Starter 162, 220
- Plant Support 243-246, 249, 250, 253-260
- Planting Mix, Outdoor 42, 45, 54-56
- Plant-tone 21, 25, 145
- Plastic Bird Baths 339, 355
- Plastic Plant Labels 23,
- Plastic Sign Holder 31
- Plastic Water Breaker..... 110
- Plastic Water Nozzle 110, 111, 117, 118, 126, 129
- Poison Ivy & Oak Killer 211, 215, 232, 233
- Polar Bear w/ Igloo 281
- Poles, Grow 245, 254, 255, 259
- Polished Stone 52
- Poly Rake 82
- Poly Tarp 96
- Poly Wheelbarrow 88
- Post Hole Digger 94
- Potash 21, 110, 153
- Potato Tub Planter 335
- Pots, Clay 293-294
- Potting Mix/Soil 15,
- Pre-Emergent Weed Control 236
- Preen 236
- Premier Tech Horticulture 54
- Preserved Moss 52, 53, 57-59
- Pressure Sprayer 107, 221
- Prima Planter..... 300-303
- Primitive Planters..... 312-315
- Pro-Mix 25
- Promo Bird Bath 355
- Promo Hand Tools 98
- Promotional 2 Gal Watering Can..... 125
- Propagation Dome 19, 21, 24, 30
- Proven Winners 166
- Pruner Holster 88, 97
- Pruner Parts 97
- Pruner/Lopper Combo Set..... 98
- Pruners 83, 92, 95, 97
- Pruners, Anvil 83, 95
- Pruners, Bypass 83, 92, 95
- Pruning Saw 93
- Pruning Sealer 185, 203,
- Pruning Set 98, 100
- Pulsating Sprinkler 113, 123
- Pulverize Weed 228

- Pump & Grow 143
 Pure Gold 143
 Purse Planter, Metal 332
 Pyrethrin Garden Insect Spray 207
- Q**
- Quad Thick 1020 Tray 27
 Quick Connectors 120, 126
 Quick Grow Grass Seed 76
 Quoddy Blend Lobster Compost 36
- R**
- Rabbit Repellents 209, 211, 218, 219
 Rabbit Scram 218
 Radians Garden 194,
 Railing Planters .. 268, 279, 284, 290, 297, 307,
 315, 336
 Rain Chain..... 172, 178
 Rain Gauge 163, 189
 Rain Wand 107, 108, 112, 129
 Raised Garden Bed Mix 36, 42, 44
 Rake, Bow 82, 90, 99
 Rakes 81, 82, 90
 Rapiclip 23, 252
 Rapidtest Kits 164
 Rasied Bed Planter 27, 279
 Rat 7 Mouse Bait Station..... 240
 Rat Magic 210
 Rattan Hanging Basket 269, 309
 Razor Tooth Folding Saw 82
 Rectangular Wood Trough..... 281, 334
 Red Lava Rock..... 47
 Red Wagon Planter 189
 Reindeer Moss 53, 59
 Repair Kit (Felco) 97
 Repellent, All Purpose Animal 210, 219
 Repels All..... 210, 211
 Replacement Blades (Felco) 97
 Replacement Bulbs, Indoor 19
 Replacement Spring Kit (Felco) 97
 Replant Kit, Earthbox 308-309
 Reptile Stopper..... 209, 227
 Rescue, Sterling 237, 238
 Retro Metal Planters 311
 Revenge Products 206, 209, 212
 Revitalize Biofungicide 212
 Revolver Nozzle 111, 126, 129
 River Gravel..... 47, 51
 River North Collection..... 180, 290
 River Rock 51,
 Rodent Control 210, 211, 228
 Rolled Rim Planter 325
 Rooster Planter..... 277
 Roosting Pockets 358
 Root & Vegetable Kit, Earthbox 308-309
 Root Gel 16,
 Root Killer..... 66, 223
 Root Riot 16,
 Root Stimulant 14, 16, 140, 141, 152, 156, 220,
 Rooting Hormone 14, 16, 20, 156
 Root-N-Grow 135
 Roots Organic Formula 707 18
 Roots Original Potting Soil 18
 Rose Care 37, 38, 204, 206, 214, 232
 Rose Food 138, 142, 151, 157, 161, 166
 Rose RX 204,
 Rose Shield 204,
 Rose Spikes 161
 Roses and Flowers Mix 37, 138, 142
 Rose-tone 21, 25, 145
 Rosie Bowl 285
 Rot-Stop 211
 Round Point Shovel..... 86, 94, 99
 Rubber Hose 114, 116, 130
 Rubber Hose Washers 110, 122, 127
 Rustic Farmhouse Collection 310
- S**
- S Hook 192, 313
 Safehaven Animal -Rodent Traps..... 225, 226
 Safer 21, 182
 Safety Vest 198
 Safflower Seed 341, 355
 Salad & Herb Grower 26
 Salamander Soil Potting Mix 45
 Sanco 238
 Sand, Decorative 40, 47, 51,
 Sanidate 21,
 Sanitizer..... 21,
 Saucer 21, 205, 208, 214
 Saws..... 82, 85, 93
 Scabbard 88, 97
 Schoodic Blend Compost Manure 37
 Schultz..... 26, 168
 Scissors..... 83, 88
 Scoop 94
 Scroll Pot Trellis 176
 Sea Based Soil 42, 44
 Sea Shell Planter..... 277
 Seabird Guano 140
 Season Long Grub Control 65
 Seaweed Liquid 155, 158, 165
 Sedge Ender 202,
 Sedgehammer Herbicide..... 233
 Seed & Cutting Mix..... 15, 16, 22

- Seed Blanket 63, 67, 73
- Seed Dispenser 23
- Seed Sower 23
- Seed Starting Kits 21, 24, 25
- Seed Starting Pellets 21, 24, 25
- Seed Starting Pots 21, 24
- Seed Starting Soil 15, 16, 21, 24-26
- Seed Starting, Lawn 68, 73, 77
- Seed Trays 21, 29
- Seeding Tool 23
- Seedling Heat Mats 17,
- Self-Watering Planters 279, 282, 288, 290, 299, 305-306, 324,
- Shady Grass Seed 74
- Shaina Planter 285
- Sharpening Tool 88
- Shears 15, 18
- Sheet Moss 52, 57
- Shepherd Hook 172, 180, 187, 190
- Shovels 86, 90, 94, 99
- Shower Planter 328
- Shut Off Valve Connectors 115, 119-122, 126, 127
- Single Drawer Planter 268, 273
- Siphon Mixer Injector 157
- Skunk Control 210
- Sledgehammer 92
- SledgeHammer Rinse 149
- Sloth Planter 275
- Slug and Snail Control 204, 205, 217, 221, 223, 227-229
- Slug Magic 205
- Sluggo 229
- Smart Pot (High Caliper Growing) 26, 27
- Snake Repellent 209
- Snips 15
- Soaker Hose 115, 116, 126, 130
- Sock, Thistle 355
- Soil Acidfier 42, 157
- Soil Conditioner 45, 147
- Soil Cover 39, 40, 47, 51, 52, 58
- Soil Moist 27
- Soil Penetrant 158
- Soil PH Tester 163
- Soil Tester 163, 164
- Solar Lights 184, 198
- Solo 100
- Sonic Spike 210, 226
- Southern Patio 315-320
- Spade 86, 90,
- Spanish Moss 52, 53, 57
- Spartan Eco Cast Urn 285
- SPC Retail/Benchmaster 60
- Sphagnum Moss 43, 47, 50, 52, 55, 58
- Sphagnum Peat Moss 41, 43, 44, 47, 54-57
- Spider and Ground Bee Control 208
- Spider Trap 235
- Spike Base Sprinkler ... 113, 123, 124, 126, 129
- Spikes, Plant 161
- Spinosad 206, 224
- Split Bamboo Fencing 260
- Sprayers 96, 100, 101, 107, 127, 221
- Spreader 66
- Spreader Sticker 203, 222
- Spring Back Rake 81, 82, 90
- Spring Lawn Booster 68
- Sprinkler High Rise 123-125
- Sprinkler Whirling 113, 123, 124
- Sprinkler, Impulse 113, 115, 123, 125, 126
- Sprinkler, Oscillating 114, 123-125
- Sprinkler, Sled Base 112, 123, 124
- Sprinkler, Spike Base .. 113, 123, 124, 126, 129
- Sprinkler, Tripod Base 115, 123, 125
- Sprinkler, Turret 113
- Sprite Succulent Pot 299
- Sprout Island Blend Seed Starter 15
- Spurge Control 202, 233
- Square Planter 264, 270-271, 273, 279-280, 286, 288-290, 298, 305, 310, 318-320, 324-325, 334
- Square Point Shovel 86, 94
- Squirrel Proof Feeder 339,
- Squirrel Repellent 211, 227
- Squirt Bottle 127
- St. Gabriel Organics 78, 240
- Stainless Steel Tools .. 84
- Stake Kit 247, 249, 250
- Stakes, Bamboo 256, 257
- Stakes, Plastic Coated 256, 257
- Stakes, Wooden 256, 257
- Staking Kit, Earthbox 308
- Star planter 281
- Starter Fertilizer, Lawn, Plant .. 68, 73, 138, 152, 162, 220
- Starter Plus, Biotone 146
- Statuary Planters 272, 334
- Steel Bird Bath Stand 351
- Steel Hose Hanger 115, 129
- Steel Watering Can 129, 132
- Steel Wheelbarrow 88
- Sterling Rescue 237-238
- Sticky Traps 235, 239
- Stone Chips 47
- Stonington Areation 36, 136
- Stonington Blend Grower's Mix 15, 36
- Stonington Blend Organic Food 15, 36

Straw	63	Swan	130	Terrazzo Series Planters	297
Strawberry Fields Potting Soil	45	Swan Planter	326	Testers, PH	21, 117, 163, 164
Strawberry Jar	326	Sweet-Seed	354	Thinning Shear	84
Stretch Tie	247, 252	Swivel Bracket	191	Thistle Sock	355
Strip Light LED	27	Swivel Hook	190	Three Tube Sprinkler Hose	88
Studio Dish Planter	271	Syndicate	131, 259, 322-324	Thuricide BT	204, 205, 224
Stump & Vine Killer	155, 211, 219, 223	Systemic Control (Disease)	204-206, 212, 215, 223	Tick and Mosquito Repellent	65, 69, 71, 204, 207, 219
Stump Out	211	Systemic Control (Drench) ..	204, 205, 228, 232	Tick Control	65, 207, 218
Succulent Fertilizer	137, 143, 150	Systemic Control (Insect)	14, 205, 206, 232	Tick Take Removable Spoon	239
Succulent Planters ..	263, 269-272, 275-282, 290, 293-295, 299, 304-306, 316-317, 322-324, 334	Systemic Granules	14, 205	Tie Tape	247
Succulent Soil Mix ..	37, 38, 41, 43, 46, 50, 54, 55	Systemic Insect Control (Acephate)	204, 205	Ties, Twist	247
Sucker Stopper	230	Systemic Rose & Flower	204, 206	Tiger Bloom	150
Suet Cakes	340, 343, 344			Tilden Planter	282
Suet Feeders	344, 347	T		Time Release Fertilizers	153, 160, 166, 168
Sulfur	153, 212, 224	T5 Light	29, 30	Tin Bird Houses	340
Sulfur Dust	212, 224	Tabletop Light Stand	30	Tin Planters ..	268-269, 271, 273, 280-281, 291, 310-311, 324, 331-333, 335
Summer Revitalizer	68	Tabletop Torch	193	Tomato & Pepper Set	220
Summer Survival Insect Control	76	Tahoe Planter	297	Tomato & Veggie Insect Control	206, 214, 217
Summit	239	Take Down Garden Spray	230	Tomato Blossom Set Spray	211, 232
Sun & Shade Grass Seed	75	Tall Planters	266, 271, 283, 289, 305, 325	Tomato Cages	258
Sun Bulb	13, 35, 135	Tampa Hanging Basket	316	Tomato Disease Control	206, 214
Sun Gro	26, 55, 56	Tank Sprayer	100	Tomato FeED	160
Sunblaster Horticultural Lighting	27, 29, 30	Tapered Edge Planter	323	Tomato Food ..	135, 136, 143, 147-149, 152, 155, 159-161, 166
Sunflower Seed	341, 355	Tapestry Planter	269-270	Tomato Spikes	161
Sunlight Calculator	164	Tarps, Poly	96	Tomato Ties	552
Sunny Grass Seed	74	TDI Brands	102, 132, 259	Tomato Tower	258
Sunshine Mix	26	Tea Cart	180	Tomatoes and Vegetables Mix	37, 143, 149
Super Gasser	201	Telescopic Tools	99	Tomato-tone	21, 25, 146
Super Manure	47	Tenax	259	Tommy Pot	280
Super Moss	57-59, 259, 353	Termite Control	209, 216	Tools, Hand	84, 98
Super Soap	208	Terra Cotta Clay Pots	293-294, 317	Top Soil	49, 56
Superthrive	26	Terra Cotta Vinyl Saucers	274	Topiaries	179, 181
Sustâne	21, 123, 168	Terranova Planter	288	Torch Fuel	193
Sutton Planter	286	Terrariums	21, 258, 314, 323		

- Totem Pole..... 44
 Touch Up Tri-Rye 76
 Transplanters 84, 98
 Traps, Disposable 237
 Traps, Fly..... 237, 238
 Traps, Japanese Beetle..... 212
 Traps, Mouse..... 226, 240
 Traps, Wasp 237, 238
 Traps, Yellow Jacket 237, 238
 TrapStik 237, 238
 Trays..... 13, 29
 Tree & Shrub Care 205, 215, 220
 Tree & Shrub Food 151, 161
 Tree and Shrub Spikes 161
 Tree Bags 259
 Tree Feast 234
 Tree Fertilizer 138, 144, 149, 151, 161, 234
 Tree Food Spikes 161
 Tree Netting 246
 Tree Pruner 85, 220
 Tree Stake 247, 249, 250
 Tree Watering Bag..... 181
 Tree Wrap..... 250
 Treekote 250
 Tree-tone 21, 25, 144
 Trellis 171, 173, 176, 181, 243, 244, 246, 254, 257-260
 Trellis Netting 246, 259
 Trellis Planter 287, 320
 Tricopyr Ester 223
 Tricycle Plant Stand 189
 Tricycle Planter 291
 Trio Pack 148
 Trio Planter 308, 323
 Triple Phosphate 146, 153
 Triplt Action..... 220
 Tripod Sprinkler 123, 125
 Trough Planter..... 280
 Trowel, Hand 84, 98
 Trunk Mat Liners 102
 Tub Trugs 81
 Tube Feeder 339, 345-347
 Tunnel, Grow 246
 Turbo 203
 Turf Booster..... 234
 Tusco Products..... 324-325
 Tuxon Planter 266
 Twine 21, 134, 250
 Twist Nozzle 110, 112, 118
 Twist Ties 247, 251, 252, 256
 Twists and Clips..... 247
 Tyne Moulds 30, 31, 260
 Typar 248
- U**
- Ultra Black Beauty Grass Seed 75
 Ultra Outdoor Planting Mix 56
 Ultra Potting Mix w/Extend Feed 56
 Umbria Eco Cast Planter 284
 Union-Cado 131, 194, 326, 355
 Universal T5 Light Strip Hanger 29
 Universal T5 Stand 30
 U-Pins..... 248
 Upright Grow Bags 17, 26, 27
 Urns..... 264, 272, 280, 283, 289, 297, 306, 319, 325-326,
 US Wire and Cable (Flexon)..... 88
 Utopian Urn Planter 319
- V**
- Vacation Mats 27
 Vase, Glass 323
 Vegetable Disease Control 206, 214
 Vegetable Food 135, 137, 143, 148, 152, 156, 168
 Vegetation Killer 201, 202
 Venetian Flower Box 297
 Vented Dome..... 19, 24
 Vermiculite 43, 48, 50
 Verona Planter..... 288
 Very Cool Stuff 194, 195, 327-334
 Vine Killer 211, 233
 Vinegar 20% 238
 Vintage Seed Buckets 190
 Vintage Watering Can..... 129
 Vinyl Hose Washers 122
 Vinyl Loop Lock Labels 31
 Vinyl Saucer 274
 Vinyl Tree Wrap 185
 Violet! 14, 15
 Volcanic Rock 47
 Vole Control 218, 227
 Vole Scram 218
 VPG 16, 43, 44, 150-154, 219-225
- W**
- Wall Decor 194, 195, 312, 314
 Wall Planter 291, 306, 312, 327, 331, 336
 Wash Tub Planter 311
 Washers, Hose 110, 122, 127
 Wasp & Hornet Killer 204
 Water Barrel 176
 Water Breaker 110
 Water Fountains 178

Water Hose, Rubber	114, 130	Wholly Mackerel Fish Fertilizer.....	149	Worm Castings	36, 41, 55, 158
Water Nozzles (Adjustable) ..	109, 110, 111, 117, 118, 126	WHY Traps	237	Woven Baskets.....	309, 320, 336
Water Retention Mat	28	Wicasset Earthworm Castings.....	36	Woven Rope Roosting Pockets	358
Water Soluble Plant Foods .	19, 20, 159, 160, 166	Wicker Planter	272	Wrap, Tree	250
Water Timer	107, 122, 126	Wilco.....	240	Wrapround Peony Support	176
Watering Can Planter	322, 327-328	Wild Delight Bird Food	355-358	Wren House	346, 3487
Watering Cans	105, 106, 114, 124, 125, 128, 129, 131, 132	Wildflower Mix	63, 78	Wren Scroll Trellis.....	173, 176
Watering Kit 2 Piece	99	Wildflowers Seed Mixture	21	Wrench	89
Watering Wands	107, 108, 112, 129	Wilt Stop.....	203		
Watson Gloves	195, 196	Wilt-Pruf.....	21, 25, 167	X	
Weed & Feed.....	65, 66, 77, 168, 202	Wind Art.....	182, 183	XXX Corner Rack	180
Weed & Grass Killer	201, 202, 203, 216, 222, 228, 235, 238	Wind Chimes	266, 268, 286, 288-290, 297, 307, 336	Y	
Weed Beater.....	201, 202, 203	Window Box Planter .	266, 268, 286, 288-290, 297	Year Round Spray Oil.....	206, 239
Weed Control	168, 201, 202, 203, 216, 222	Window Box Planter Tray	297, 307	Yellow Jacket Traps	237, 239
Weed Fabric	248, 249	Windy Wings	182, 183	Yield Booster RTU.....	220
Weed Preventer, Garden.....	168	Winter Fabric	246, 249	Y-Shut Off Connector	119, 121, 127
Weed Preventer, Lawn	168, 201	Winterizer	68, 76	Z	
Weed Prevention Plus	236	Wire Basket Planter.	272, 292-293, 309, 320, 336	Zerotol HC	21, 12
Weeder	81, 84, 85, 87	Wood Grain Planter.....	279	Zinc Homerowner Bait.....	240
Weep and Soak Hose.....	116, 130	Wood Plant Stand	287	Zinc Plant Labels.....	23
Western State.....	162	Wooden Obelisk	287	Zinc Pots.....	330-333
Whiskey Barrel	284, 296, 319	Wooden Planters	287, 296	Zinc POTS.....	330-333
White Marble	51	Wooden Tree Stake Kit	247, 249, 250	Zinc Supplement.....	162
White Sand	40, 51	Wooden Trellises	243, 244, 254, 258	Zinc Water Couplers	119, 120
White Stone	51	World Source Partners	31, 132, 198, 260, 335-336, 358	Zombie Flamingos.....	194

Credit Application

INTERESTED IN APPLYING FOR CREDIT?

Credit applications can be completed online.
 Email creditapplication@griffinmail.com to
 receive an email with a link to our secure online portal.

If you are unable to access the online form you can call
 us at 800.888.0054 and ask for the Credit Dept.





GriffinExpo

SAVE THE DATES!

Virtual Expo

August 19 - October 31, 2024

In-Person Expos

August 28-29, 2024

Silver State Pavilion at Grand Sierra
Reno, NV (**New Location**)

September 25-26, 2024

New Jersey Convention and Expo Center
Edison, NJ

POINT OF PURCHASE SIGNAGE

from Griffin

High-quality signage, at affordable prices, with NO minimums! Available in pre-designed and custom options!

Perennials

FREE DESIGN WORK

ON ALL CUSTOM ORDERS!

Custom Coroplast Posters

- Printed in UV cured ink/long-lasting durability
- Full color bleeds
- Durable high-quality outdoor 4mm coroplast
- Shipped within 5 days of proof approval
- Custom sizes available

Options

- Grommets in top corners - Free
- Double Sided - Additional cost, same as front or new image

Step stakes available
Item # PP-SS

Custom Vinyl Banners

- Printed in true digital color
- Full color bleeds
- Durable high-quality outdoor 13oz scrim vinyl
- Reinforced on all 4 sides with banner welding
- Drop-shipped within 5 days of proof approval

Options

- **Grommets** (2-3') - Free
- **Rope** - Additional cost
- 500 pound nylon cord welded with 2' of slack
- Location: top, bottom, top & bottom
- **Pole Pockets** - Additional cost
- Size: 1, 2, 3, or 4" (Dimensions unchanged)
- Location: top, bottom, top & bottom, left, right, left & right

Many other substrates available. | Call Customer Service
Ask your sales person for more details.



Perennials



Sunny Annuals



Shade Annuals



Herb Garden



Vegetables



Poinsettias

Pre-designed Poster Options

- 2 sided printing on Coroplast
- Full color print
- UV coated
- Grommets for easy hanging (24x36)

16" x 24"

Item	Description
PP-1623PE	Perennials
PP-1623PO	Poinsettias
PP-1623SH	Shade Annuals
PP-1623SU	Sunny Annuals
PP-1623VG	Vegetables
PP-1623HG	Herb Garden

24" x 36"

PP-2436PE	Perennials
PP-2436PO	Poinsettias
PP-2436SH	Shade Annuals
PP-2436SU	Sunny Annuals
PP-2436VG	Vegetables
PP-2436HG	Herb Garden

GROWING CALENDAR

Starshine Blue from Syngenta Flowers

Full Moon Days
 Holidays

2023

JULY

WEEK	S	M	T	W	T	F	S
26							1
27	2	3	4	5	6	7	8
28	9	10	11	12	13	14	15
29	16	17	18	19	20	21	22
30	30 ²³	31 ²⁴	25	26	27	28	29

AUGUST

WEEK	S	M	T	W	T	F	S
31			1	2	3	4	5
32	6	7	8	9	10	11	12
33	13	14	15	16	17	18	19
34	20	21	22	23	24	25	26
35	27	28	29	30	31		

SEPTEMBER

WEEK	S	M	T	W	T	F	S
35						1	2
36	3	4	5	6	7	8	9
37	10	11	12	13	14	15	16
38	17	18	19	20	21	22	23
39	24	25	26	27	28	29	30

OCTOBER

WEEK	S	M	T	W	T	F	S
40	1	2	3	4	5	6	7
41	8	9	10	11	12	13	14
42	15	16	17	18	19	20	21
43	22	23	24	25	26	27	28
44	29	30	31				

NOVEMBER

WEEK	S	M	T	W	T	F	S
44				1	2	3	4
45	5	6	7	8	9	10	11
46	12	13	14	15	16	17	18
47	19	20	21	22	23	24	25
48	26	27	28	29	30		

DECEMBER

WEEK	S	M	T	W	T	F	S
48						1	2
49	3	4	5	6	7	8	9
50	10	11	12	13	14	15	16
51	17	18	19	20	21	22	23
52	31 ²⁴	25	26	27	28	29	30

2024

JANUARY

WEEK	S	M	T	W	T	F	S
1		1	2	3	4	5	6
2	7	8	9	10	11	12	13
3	14	15	16	17	18	19	20
4	21	22	23	24	25	26	27
5	28	29	30	31			

FEBRUARY

WEEK	S	M	T	W	T	F	S
5					1	2	3
6	4	5	6	7	8	9	10
7	11	12	13	14	15	16	17
8	18	19	20	21	22	23	24
9	25	26	27	28	29		

MARCH

WEEK	S	M	T	W	T	F	S
9						1	2
10	3	4	5	6	7	8	9
11	10	11	12	13	14	15	16
12	17	18	19	20	21	22	23
13	31 ²⁴	25	26	27	28	29	30

APRIL

WEEK	S	M	T	W	T	F	S
14		1	2	3	4	5	6
15	7	8	9	10	11	12	13
16	14	15	16	17	18	19	20
17	21	22	23	24	25	26	27
18	28	29	30				

MAY

WEEK	S	M	T	W	T	F	S
18				1	2	3	4
19	5	6	7	8	9	10	11
20	12	13	14	15	16	17	18
21	19	20	21	22	23	24	25
22	26	27	28	29	30	31	

JUNE

WEEK	S	M	T	W	T	F	S
22							1
23	2	3	4	5	6	7	8
24	9	10	11	12	13	14	15
25	16	17	18	19	20	21	22
26	30 ²³	24	25	26	27	28	29

JULY

WEEK	S	M	T	W	T	F	S
27		1	2	3	4	5	6
28	7	8	9	10	11	12	13
29	14	15	16	17	18	19	20
30	21	22	23	24	25	26	27
31	28	29	30	31			

AUGUST

WEEK	S	M	T	W	T	F	S
31					1	2	3
32	4	5	6	7	8	9	10
33	11	12	13	14	15	16	17
34	18	19	20	21	22	23	24
35	25	26	27	28	29	30	31

SEPTEMBER

WEEK	S	M	T	W	T	F	S
36	1	2	3	4	5	6	7
37	8	9	10	11	12	13	14
38	15	16	17	18	19	20	21
39	22	23	24	25	26	27	28
40	29	30					

OCTOBER

WEEK	S	M	T	W	T	F	S
40			1	2	3	4	5
41	6	7	8	9	10	11	12
42	13	14	15	16	17	18	19
43	20	21	22	23	24	25	26
44	27	28	29	30	31		

NOVEMBER

WEEK	S	M	T	W	T	F	S
44						1	2
45	3	4	5	6	7	8	9
46	10	11	12	13	14	15	16
47	17	18	19	20	21	22	23
48	24	25	26	27	28	29	30

DECEMBER

WEEK	S	M	T	W	T	F	S
49	1	2	3	4	5	6	7
50	8	9	10	11	12	13	14
51	15	16	17	18	19	20	21
52	22	23	24	25	26	27	28
1	29	30	31				



CONTACT GRIFFIN

Phone: 800.888.0054

Grower/Retail Fax: 877.636.3623

Green Goods Fax: 630.969.6373

Email: orders@griffinmail.com

Online Ordering: www.griffins.com